

POPULAR SCIENCE

MONTHLY

MECHANICS AND HANDICRAFT 



Midget Helicopter

PAGE 85

35¢ January



Willys Makes America's Newest Light Car PAGE 116

THIS IS AMERICA

Told as Never Before, in Dramatic
 Firsthand Eyewitness Stories!
 Told in 1,000 Stirring Pictures
 that Make these Events Come to Life Before Your Eyes!

Race a rumbling, groaning covered wagon into newly opened Indian territory to stake claim to rich farmlands. Live rugged life of pioneers—told you in their own words or by eyewitnesses!



"What a Story!"

PENPED in words that catch fire and leave you breathless. These are books that must stir to new pride and courage the soul of every American whether he is American by birth or by choice! What a story! What a succession of fascinating personalities!

As an On-The-Spot Eyewitness You Live Hundreds of Thrilling Events

Call the roll of the great... Drake, Vespucci, Cabot, Washington, Franklin, Madison, Hamilton, Henry, Commodore Barry, Adams, Webster, Friar Serra, Andrew and "Stonewall" Jackson, Lincoln, Black Hawk, Custer, Hill, Carnegie, Vanderbilt, Ford, Edison, Theodore and Franklin Roosevelt, Hoover and hundreds more!

Here they all are to tell you in person — in their letters, their diaries, their per-

sonal records — the creative adventures which shaped our destiny. In flaming words and over 1,000 thrilling pictures we are *there* — on-the-spot eyewitnesses — actual participants! We gain a new concept of our American Heritage!

Not Interpretations, but Hundreds of Exciting Firsthand Stories!

With Columbus, hear shout "Land, ho!" herald the world's greatest discovery; let his own words reveal the powerful little-known drama of his life.

Hear from their own lips the daring adventures of courageous settlers and Jesuit missionaries carving a free new world out of wilderness.

With Paul Revere you see the flickering beacon of Old North Church blaze into brilliant fire of Freedom... You are with Washington in desolation at Valley Forge and in triumph at Yorktown... You sit beside Jefferson as he writes the Declaration of Independence and assist in imagination at the birth of a nation.

See a nation re-united as Grant and Lee clasp hands in friendship at Appomattox. Hear Lincoln, at Gettysburg, deliver his immortal address.

Read how Commodore Perry opened the door to Japan; and foresaw "a mighty battle (with Russia) on which will depend the freedom or slavery of the world." Thrill to exciting lives of Pioneers, Sea Captains, Empire Builders and HUNDREDS who made America great!

Paddle and portage birch canoes on grueling 3,000-mile voyage of discovery with Jesuit missionary-explorers Father Marquette and Joliet.



See savage border incidents between States! Famous Americans put prices on each other's heads!

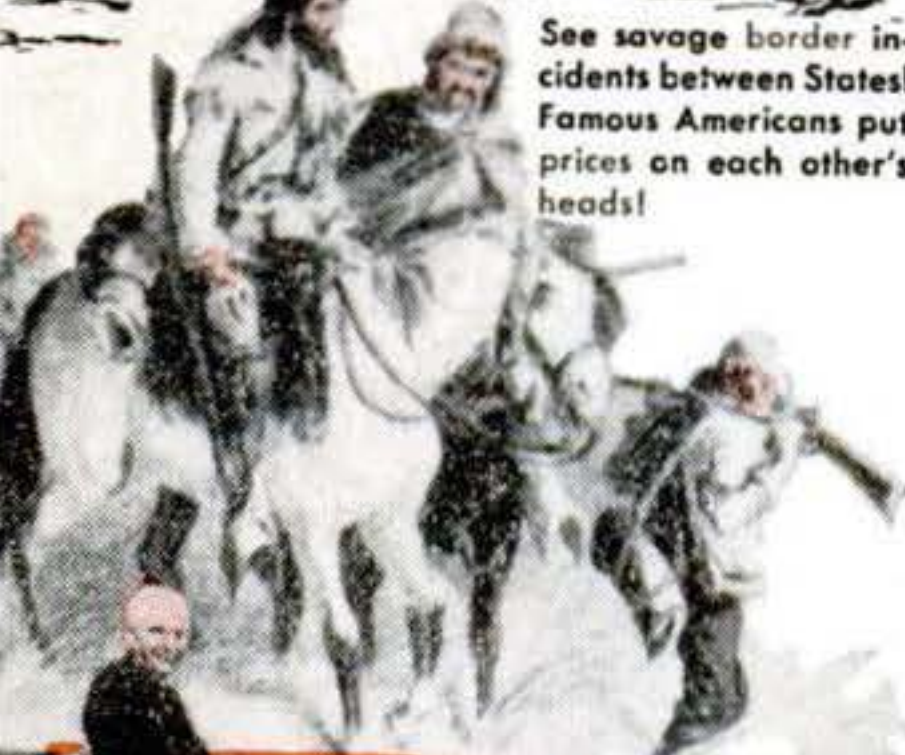

See American genius enriching our lives with airplanes, railroads, electricity, telephones, telegraph! Left: Henry Ford in his first automobile.



"Millions for defense, but not a cent for tribute!" See victory over Barbary Pirates win freedom of sea!



"Buffalo Bill" killing buffaloes to feed railroad workers. Thousands came West to hunt valuable hides; many stayed as settlers, carving new states for Union.

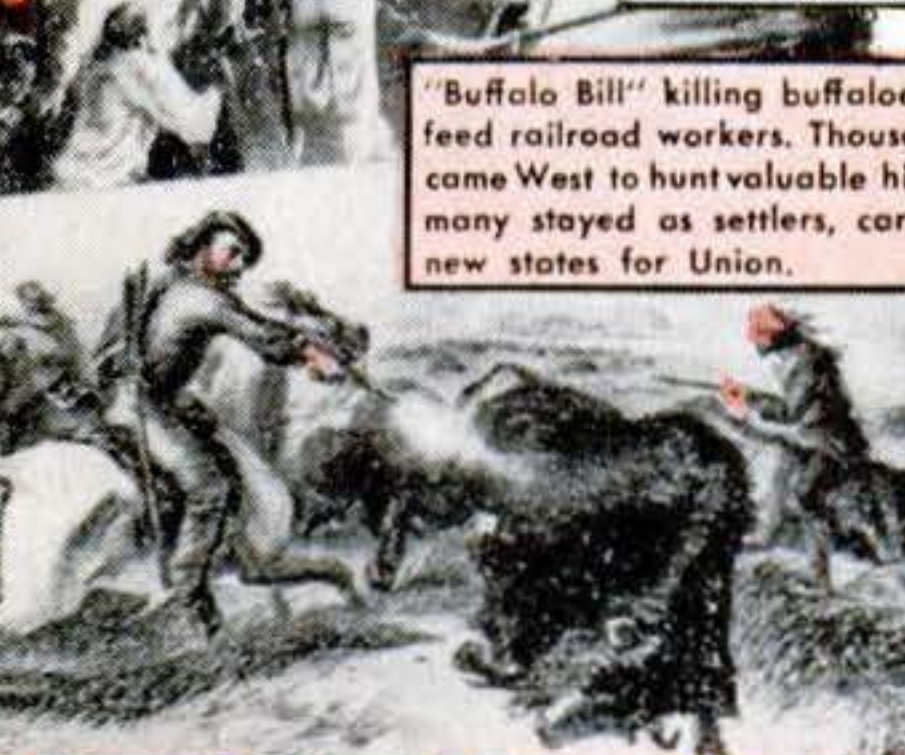

Mighty Men and Women March through these Magic Pages!

HOW AMERICA BEGAN

- The Voyages of the Norsemen, from *The Saga of Eric the Red*
- Prologue and Travels by Marco Polo
- Battle with the Iroquois by Champlain
- Report to Raleigh
- The Mayflower Compact
- How the Pilgrim Fathers Lived
- 15 Months as a Slave of Indians—Father Isaac Jogues
- Lord Baltimore's Plantation
- Witchcraft in New England
- Indentured "White Slaves"
- Secret History of the Dividing Line
- Captured by Indians by Mrs. Mary Rowlandson
- Bringing Christianity to the Illinois by Marquette and Dablon

HOW AMERICA WON ITS INDEPENDENCE

- Braddock's Defeat by Geo. Washington
- Wolfe Defeats Montcalm at Quebec
- The Hutchinson Riot
- The Boston Massacre by an Eyewitness
- Daniel Boone Migrates to Kentucky
- First Continental Congress, J. Adams
- Battle of Concord by Wm. Emerson
- Paul Revere Tells of His Ride
- The Dramatic Capture of Ticonderoga by Ethan Allen
- Call for Independence by Tom Paine
- Original Draft of the Declaration
- Conditions at Valley Forge
- Arnold's Treason by Washington
- Framing the Constitution, Madison
- Evils that Prompted Shay's Rebellion
- Battle of the Kegs by F. Hopkinson
- Lafayette's Impression of America

What other books can boast such famous contributors? Pioneers, Generals, Inventors, Statesmen, Explorers, Empire Builders, Sea Captains... all share thrilling experiences with you. 8 great narratives by Dr. Donald H. Sheehan of Columbia University give you the Over-All Story and detailed background for the hundreds of exciting eyewitness accounts. Here's a tiny hint of the vast contents that would cost a small fortune in individual books.

OUR NEW NATION GETS FIRMLY ESTABLISHED

- The XYZ Correspondence
- Crossing the Great Divide, Lewis
- The Trial of Aaron Burr
- The Chesapeake Outrage
- The Battle of Tippecanoe
- The Constitution Captures Guerriere
- The Battle of New Orleans
- Building Erie Canal by Wm. Seward
- The Turbulent Election of 1828
- The Diary of John Quincy Adams

THE U. S. GROWS STRONG—SURVIVES A CIVIL WAR

- The First American Locomotive
- Pioneering Against Slavery, Garrison
- Why U. S. Bank Was Closed, Jackson
- Slave-Breaking in the South
- Fall of the Alamo by Capt. Potter
- The Mormon Exodus to Utah
- Underground Railroad by Levi Coffin
- Perry's Treaty with Japan
- The Peninsular Campaign
- The Assassination of Lincoln
- Steamboat Pilots, by Mark Twain
- Oregon Trail by Francis Parkman
- Two Years before the Mast by Richard H. Dana

THE FRONTIERS VANISH—FACTORIES REPLACE FARMS

- Laying Atlantic Cable—Cyrus Field
- Impeachment of Andrew Johnson
- Ku-Klux Klan by Federal Grand Jury
- Great Chicago Fire by Horace White
- Carpet-Bag Government by Jas. Pike
- Progress and Poverty by Henry George
- Up from Slavery, Booker Washington
- Theodore Roosevelt and the Trusts
- A Son of the Middle Border
- Pioneer Days in Kansas by Cordley

HOW WE MEET NEW PROBLEMS OF BUSINESS AND GOVERNMENT

- Debs Railway Strike by H. T. Peck
- The Discovery of Gold in Alaska
- Battle of Manila Bay by Dewey
- The San Francisco Earthquake
- The Human Side of Panama Canal
- Building by George W. Goethals
- Pearly Discovers the North Pole
- Shame of the Cities, Lincoln Steffens
- History of Standard Oil Co., Tarbell
- First Battle by Wm. Jennings Bryan
- Message to Garcia by Elbert Hubbard
- The New Freedom by Wilson

WORLD WAR I AND THE 1920's

- The Lusitania Sinking
- Wilson's "Fourteen Points"
- Close-Up of Argonne Battle
- Airplane Duels by Rickenbacker
- The Kellogg Peace Pact
- The Big Four by Robert Lansing
- The Senate and the League, Lodge
- Coolidge, by Irwin Starling
- The Dissenting Opinions of Oliver Wendell Holmes
- The Crash by Francis Hirst
- Philosophy of Rugged Individualism
- My Life and Work by Henry Ford
- Wall Street Under Oath by F. Pecora

DEPRESSION TO PROSPERITY AND WORLD WAR II

- The NRA by Hugh Johnson
- New Order in Far East
- Four Freedoms; The Atlantic Charter
- Roosevelt I Knew by Frances Perkins
- This I Remember, Eleanor Roosevelt
- Challenge to Liberty by H. Hoover
- T.V.A. by David Lilienthal
- Memoirs of Cordell Hull
- War-time Mission to Spain by Hayes
- One World by Wendell Willkie
- Speaking Frankly by James Byrnes
- Mission to Moscow by Jos. E. Davies
- Decision in Germany by Lucius Clay
- Inside U.S.A. by John Gunther
- And Hundreds More!

Mail

Examine Both Books 10 Full Days FREE!

MY COUNTRY

Told by the Very Men and Women Who Lived—and Make You Live—the Momentous Events that Made Our Country Great!

Our Heritage of Freedom and Courage—A Future More Glorious Than Our Past

Our country has survived many bleak periods...when the states were split asunder—when Greenbacks grew almost worthless—when our very Capitol lay in ashes. We thrived on such crises and grew stronger, more closely united, more powerful. Thus it will always be!

Don't let Communists lie to us about our country and undermine our hard-won freedoms. We can gain the power and knowledge to combat them. As we read these volumes we begin to understand the miracle that is America.

We learn *why* and *how* it became the most powerful nation—the finest place on earth to live. *Why* we enjoy the greatest freedom—receive more of the world's goods for an hour's work than any other peoples in the world!

Rich Entertainment, Wisdom and Inspiration for Us and Our Children

With such a heritage goes a sacred duty to perpetuate the glorious traditions that made us great and free. Let us claim this magnificent library with its over 1,000 pictures...Let our children learn what Americans have done in the past, and they will face the future resolute in their ability to enrich their inheritance.

Scope of Vast and Costly Library—Yours at Miracle Bargain!

Without obligation, for 10 days' FREE Trial, thrill to these 2 giant DeLuxe volumes—to over 1,000 pictures, hundreds of eyewitness stories. See how they bring you scope of a vast exciting library worth hundreds of dollars! Our pre-publication plans were to sell set at \$20.00, or \$10.00 a volume. Think of getting them at miracle bargain of only \$4.95 each! SEND NO MONEY! After 10 days' enjoyment return books and owe nothing. Keep them only if supremely delighted, at easy monthly terms. Before it's too late, mail FREE Trial Coupon NOW!

1952, Wm. H. Wise & Co., Inc., 50 W. 47 St., New York 19, N. Y.

Coupon While They Last!



Sail with Columbus on long voyage into the "Sea of Darkness." Read the great discoverer's own letters describing fabulous wealth of the New World and plans for converting natives to Christianity.

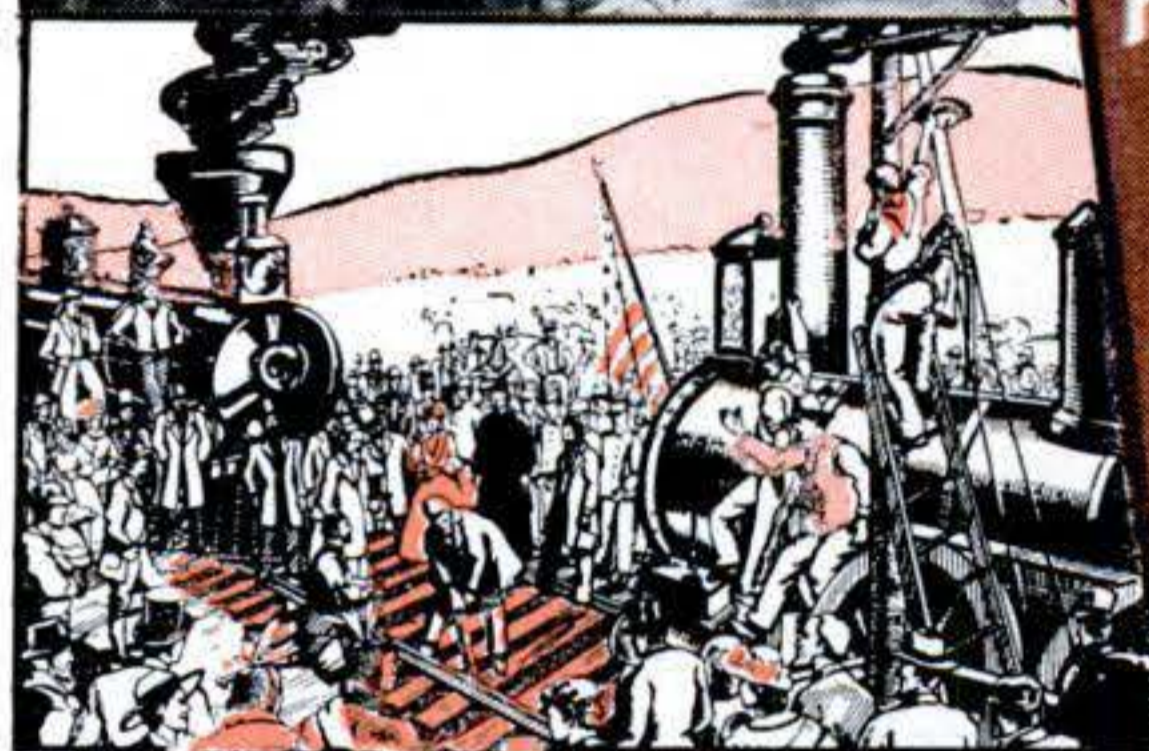

Witness industrial expansion unequalled in all history! Drive golden spike marking completion of America's first transcontinental railroad, May 10, 1869.

Hundreds of Strange and Little Known Facts

- Learn why Texas reserved the right to divide itself into 6 States!
- Why Jefferson refused at first to draft Declaration of Independence!
- How idea of Secession originated in the North—long before Civil War!
- How a Vice President plotted to set up his own empire!
- Why Napoleon sold us 1,000,000 square miles of land for only 4c an acre!
- How Lincoln's assassination was part of wider plot to kill Vice President, Secretary of State and leading Generals too!
- How Boston Tea Party was caused by colony's own Governor!
- Why Seward used his own personal funds to persuade U.S. to purchase Alaska!
- How influential members of Congress plotted to sell out our men at Valley Forge!
- How freedom of press was born!

THIS IS AMERICA MY COUNTRY

THIS IS AMERICA MY COUNTRY

Over 1000 PAGES 1000 PICTURES

2 giant 7" x 10" De Luxe Volumes, bound in genuine Morocco-Grained Artcraft, hand-tooled design in colors of red and gold. Scope of vast costly library at miracle bargain!

Mail this FREE-Trial Coupon TODAY!

Wm. H. Wise & Co., Inc., 50 W. 47th St., New York 19, N. Y. Ship me without obligation, for 10 days FREE enjoyment, "THIS IS AMERICA—MY COUNTRY"—2 magnificent DeLuxe Volumes covering the scope of a vast exciting library. If completely delighted, I'll keep them at miracle low price of only \$4.95 plus postage for each book—payable at easy rate of only \$2 monthly. Otherwise I'll simply return books after 10 days and owe nothing. It is understood I am to receive same 2 volumes you originally planned to publish at \$20.00.

MR. _____
MRS. _____
MISS _____

(Please print plainly in block letters)

ADDRESS _____

CITY & ZONE _____

STATE _____

SAVE MORE! Remit only a ten dollar bill now and we stand all packing and shipping costs. Immediate refund if you return books.

VOLTA TORREY, EDITOR • Howard Allaway, MANAGING EDITOR
Howard C. Jensen, ART EDITOR • Frank Rowsome, Jr., ASSISTANT MANAGING EDITOR

SENIOR EDITORS: Harry Walton (Mechanics & Handicraft), Hartley E. Howe (Features), Martin Mann (Copy).

ASSOCIATE EDITORS: Alden P. Armagnac, Devon Francis, Sheldon M. Gallagher, Kendall W. Goodwyn, Robert Gorman, Wesley S. Griswold, Herbert O. Johansen, Herbert R. Pfister, Denis Sneigr, Robert P. Steverson, Ruth Westphal, Andrew R. Boone (Los Angeles).

ART: Harry Samuels (Director), Herbert Anthony, Rolf O. Erickson, Eric Karminski Jr., Richard Meyer, Frances Cooper Daniels.

PHOTOGRAPHY: W. W. Morris (Director), Hubert Luckett, Orlando Guerra.

EDITORIAL ASSISTANTS: Julia C. Bove, Carol Ennis, Rita K. Gilbert, Rosemary C. Knorr, Georgette Sparks, Harriet Trowbridge.

This Month's Big Features:

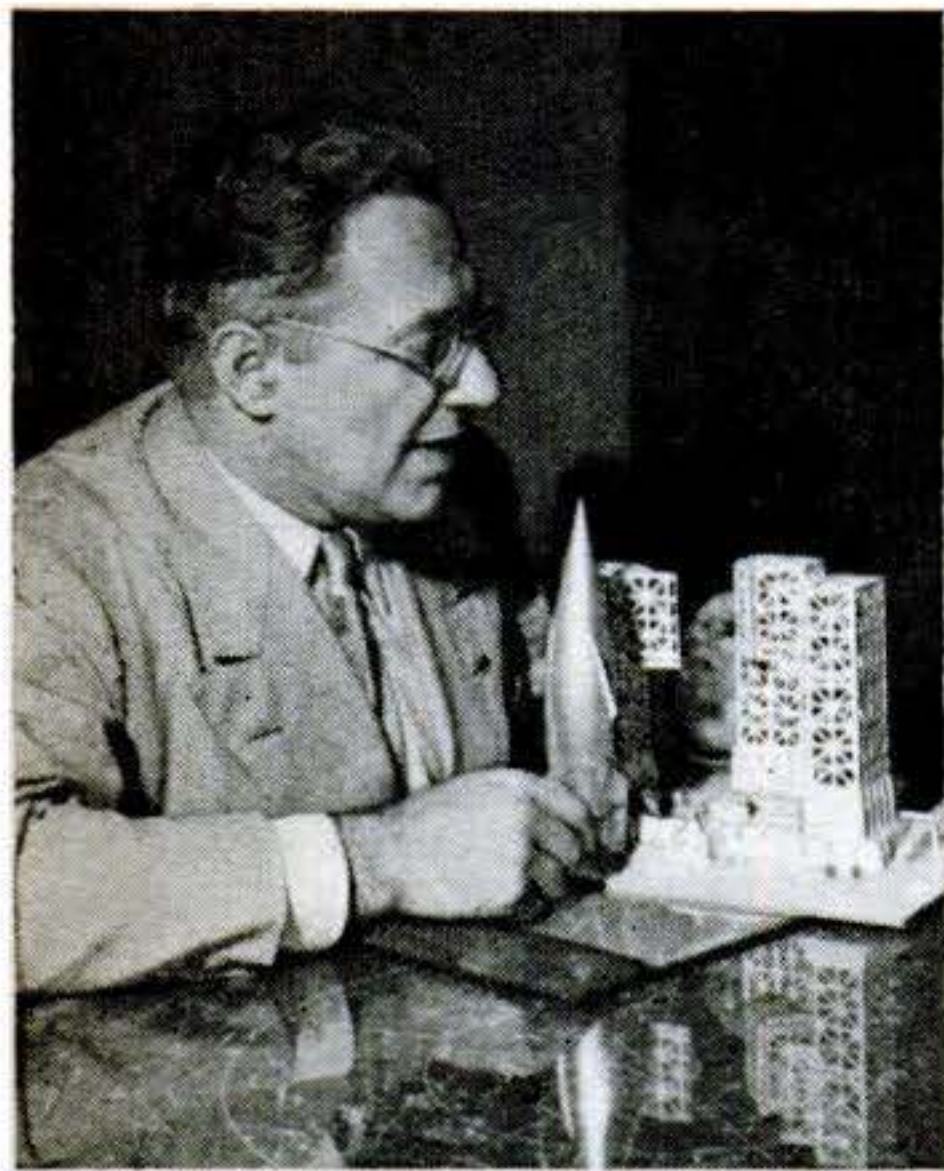

Willy Ley is an outstanding authority on rockets, and author of such popular books as *The Conquest of Space and Rockets*, *Missiles*, and *Space Travel*. On page 137 he projects Jules Verne's famous globe-girdling tale 80 years into the future.

Death Designed This Fire Truck..... 81

Men Will "Wear" This Helicopter..... 89

How a One-Armed Bandit Works..... 91

Trouble Is Their Pastime..... 96

'52 Pontiac Has New Power Train.....101

Railroading at 72° Below.....110

America's New Light Car.....116

Jackpots in Suggestion Boxes.....125

How a Champ Drives a Truck.....156

Electric Trains Are Fun All Year.....161

Tune Your TV Set from Across the Room....167

How an Expert Soups a Stock V-8.....172

Gus and the Car That Wouldn't Turn Left...178

Hamper Dries the Clothes, Too.....183

Get Acquainted with Files.....186

His Camera Earns Over \$500 a Day.....192

How to Use Patterns with Power Tools.....196

How Compressed Air Can Help You.....212

(More features and departments are listed on page 4.)

Godfrey Hammond, PUBLISHER • Stephen P. Glennon, ADVERTISING DIRECTOR

ADVERTISING OFFICES: NEW YORK — 353 Fourth Ave.; CHICAGO—360 North Michigan Ave.; DETROIT—820 Book Bldg.; SAN FRANCISCO—681 Market St.; CLEVELAND—328 Citizens Bldg.; LOS ANGELES—1052 West 6th St.
EDITORIAL OFFICES: 353 Fourth Avenue, New York 10, N. Y.

Popular Science Monthly is published monthly at 353 Fourth Avenue, New York 10, N. Y., by Popular Science Publishing Co., Inc., Godfrey Hammond, President and Treasurer; R. C. Wilson, Stephen P. Glennon, Vice-Presidents; F. W. Briggs, Secretary. Entered as second-class matter Dec. 28, 1918, re-entered as second-class matter July 26, 1948, at the Post Office in New York, N. Y., under the act of March 3, 1879; additional entry as second-class matter at Dayton, Ohio. Entered as second-class matter at the Post Office Department, Canada. Printed in U.S.A. Copyright, 1951, by Popular Science Publishing Co., Inc. All rights reserved in the United States, Great Britain, and in all countries participating in the International Copyright Convention and Pan-American Copyright Convention. Yearly subscriptions to United States, its possessions and Canada, \$3.00 (2 years, \$5.50; 3 years, \$7.50); foreign countries \$1 per year extra. Subscribers must notify us of change of address four weeks before next publication. Be sure to give both old and new addresses, including zone numbers. Vol. 160, No. 1.

Piston ring progress

1945



The life of tank and aircraft engines early in the North African campaign was measured not in terms of months, weeks, or days . . . desert heat and sand wore out cylinders, pistons and rings in a matter of *hours!* Prolonged efficient operation was a military necessity and it was achieved through the application of solid chrome plate to the piston rings.

1946-50



The experience with chrome under the most severe operating conditions was applied by Perfect Circle engineers to peacetime service in tractors and trucks. Improvements were made in ring design and plating techniques . . . astonishing records were established for economy, piston ring and cylinder life.

1951



The advantages of solid chrome plating on both oil and compression rings were then made available to car owners everywhere in the Perfect Circle 2-in-1 Set. And, to assure peak performance regardless of cylinder condition, two springs were supplied with each oil ring . . . normal pressure, for new, rebored, or slightly worn engines . . . HiPressure for badly worn engines or known oil pumpers.

TODAY the 2-in-1 Set is recognized as an outstanding example of piston ring progress. Sustained power for thousands of extra miles, positive oil control, more than double the life for cylinders, pistons and rings . . . all are features that make the Perfect Circle 2-in-1 Chrome Piston Ring Set a success unequalled in piston ring history.

Perfect Circle

PISTON RINGS

The Standard of Comparison





Just Like Magic

for making or mending

— these amazing **Wizards with Wood**

Handy with your hands? Have your own workshop? Like to do odd jobs? You'll bless the day you discover the magical results you can obtain with Firzite, Satinlac and Weldwood Glue. At hardware, paint and lumber dealers. And mail coupon for free leaflets.

A MUST for Finishing Fir Plywood



Tame that wild grain with FIRZITE. Virtually prevents grain raise or checking... readies the surface satin-smooth for paint, stain or enamel. (For blond, pickled, or tinted effects on soft or hard woods, use White Firzite).

FIRZITE*

Newer than Shellac or Varnish



Pints, Quarts, Gallons

For "natural wood" finishes on furniture, panelling or woodwork, there's nothing like Satinlac. Brings out natural grain and color beauty of any plywood or solid wood. Avoids that "built-up" look; will not turn yellow or darken with age. "Water-clear," easy to brush or spray, dries ready for next coat in 2 or 3 hours.

SATINLAC*

Glue That's Stronger than Wood



To make things or fix things, use Weldwood Glue for all wood-to-wood bonds. Makes joints stronger than the wood itself. Mixes easily with water. Stain-free, rot-proof...highly water-resistant!

WELDWOOD® PLASTIC RESIN GLUE

*Trade Marks

United States Plywood Corporation,
Dept. 365, 55 West 44th St., New York 18, N.Y.
Send me free leaflets on Weldwood Glue, Firzite and Satinlac.

NAME _____

ADDRESS _____

Picture Features

Atom Pile to Run on Uranium Pill.....	86
"High-Hat" Hot Rods.....	94
How Niagara Falls Will Work Nights....	103
Baby Gas Turbine Runs Pump.....	123
Precast Walls Go Up in a Day.....	128
How Asphalt Tile Is Made.....	132
4-Deck Parking Lot Uses Drawbridges..	134
Scientist Invents Color-TV Tube.....	145
Loggers Invade African Jungle.....	150
Why Supersonic Planes Go Boom.....	154

Mechanics & Handicraft

Where's the Car Key?.....	177
Get More Out of Basement Shelves.....	190
Sparks from Your Fingers.....	202
Sawing Tapers to the Line.....	209
Homemade Sandblaster.....	215
Milling in Your Drill Press.....	218
How to Round Corners.....	222

Departments

Letters	14
New Ideas from the Inventors.....	113
Keeping the Home Shipshape.....	121
Aids to Modern Living.....	142
I'd Like to See Them Make.....	148
P.S. Last Minute News and Notes.....	160
Hints from the Model Garage.....	181
New Tools.....	210
New Shop Ideas.....	216

NEXT MONTH:

Balancing for Power

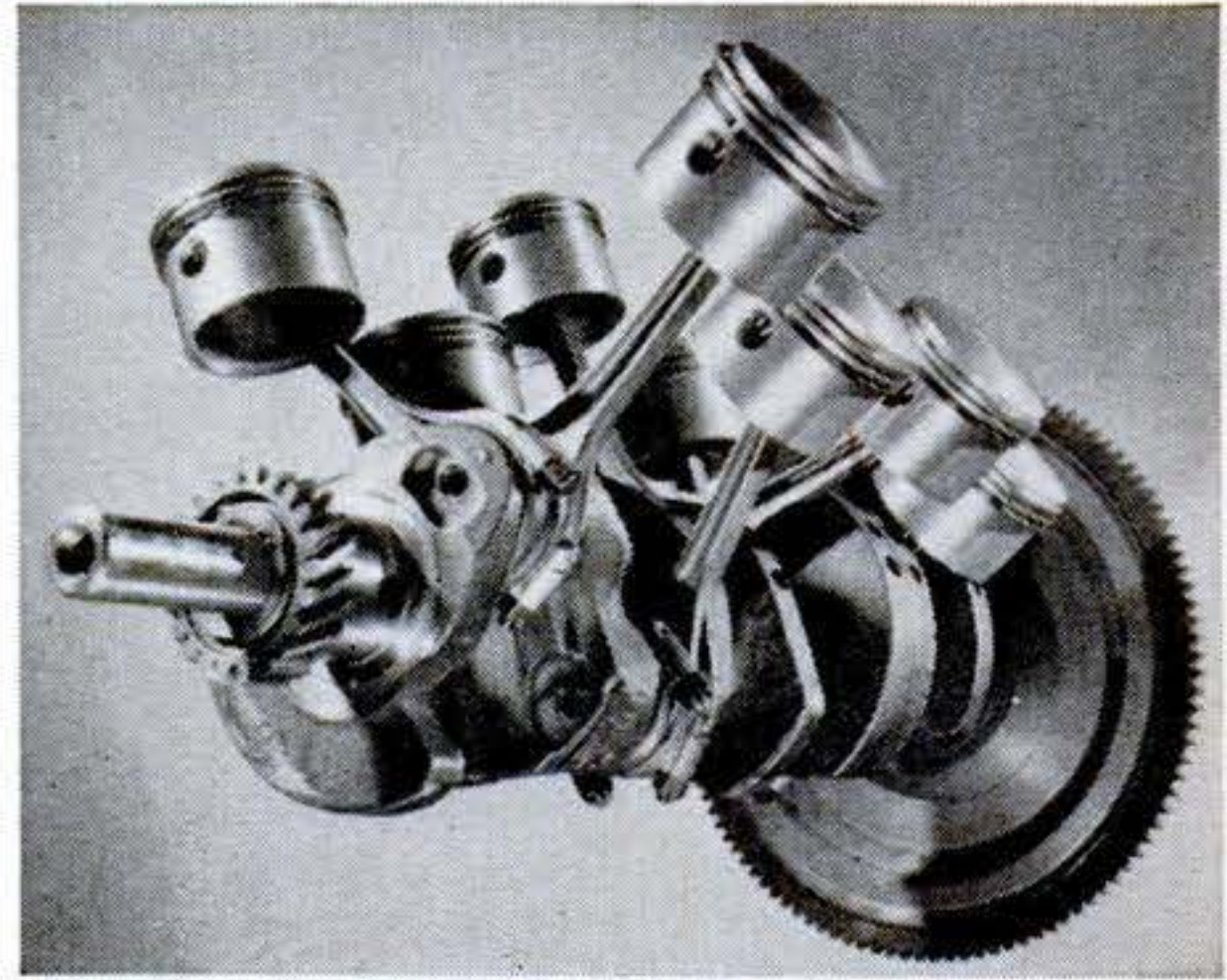

Finely crafted parts like these move at high speed to pour out the power from your auto engine. If they are only slightly out of balance, vibration and greatly increased bearing loads soak up power, wear out the engine before its time. Next month, PS tells you about an expert, one of a handful in the U. S., who rebalances stock engines until they are as smooth as cream—and more powerful than before.

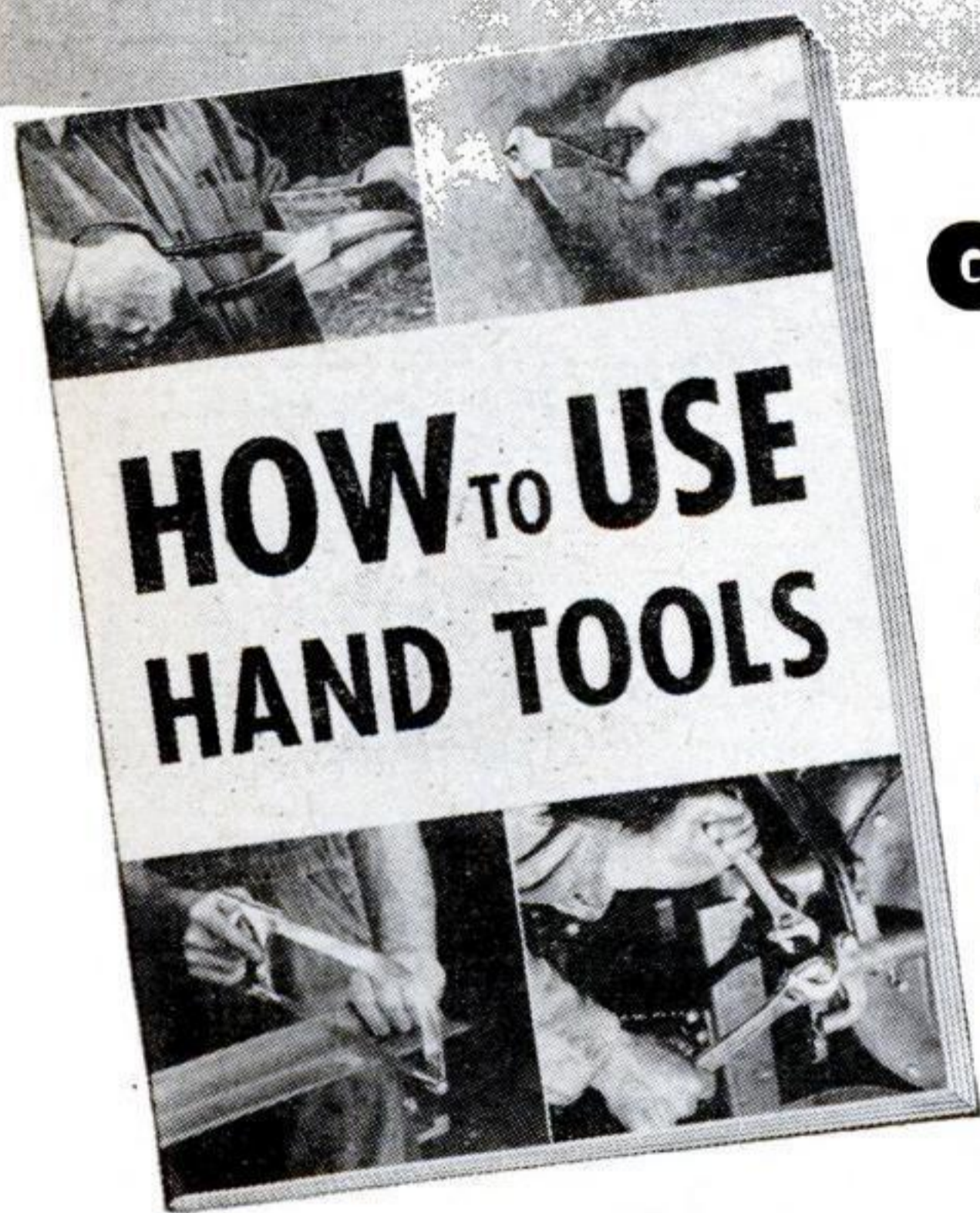
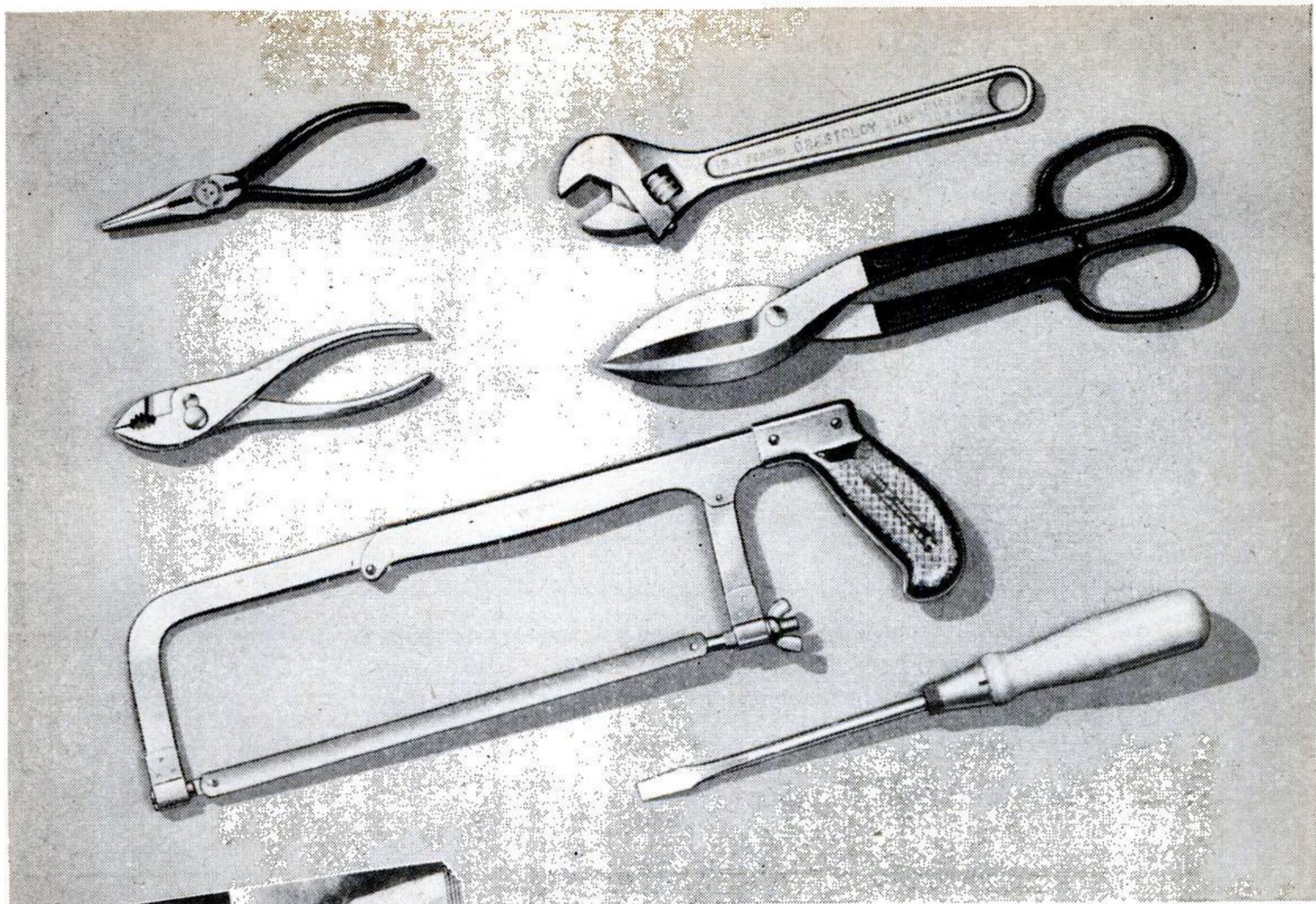

GOOD TOOLS

... save time ... reduce costs

Users of Crescent and Crestoloy Tools have long since learned the economy of paying just a little more (than "cheap" tools cost) to get a whole lot more in hand tool quality. Superior tool design not only reduces worker fatigue but produces more and better output. The longer life of Crescent and Crestoloy Tools definitely reduces maintenance and replacement costs.

GET YOUR FREE COPY . . .

This new 20-page booklet provides many useful how-to-do-it ideas for both amateurs and professional mechanics, as well as basic information on the proper selection, use and care of hand tools. 93 illustrations. Write today, Dept. 152.

CRESCENT TOOLS

Give Wings to Work

*Sign of the Artisan
Symbol of Excellence*

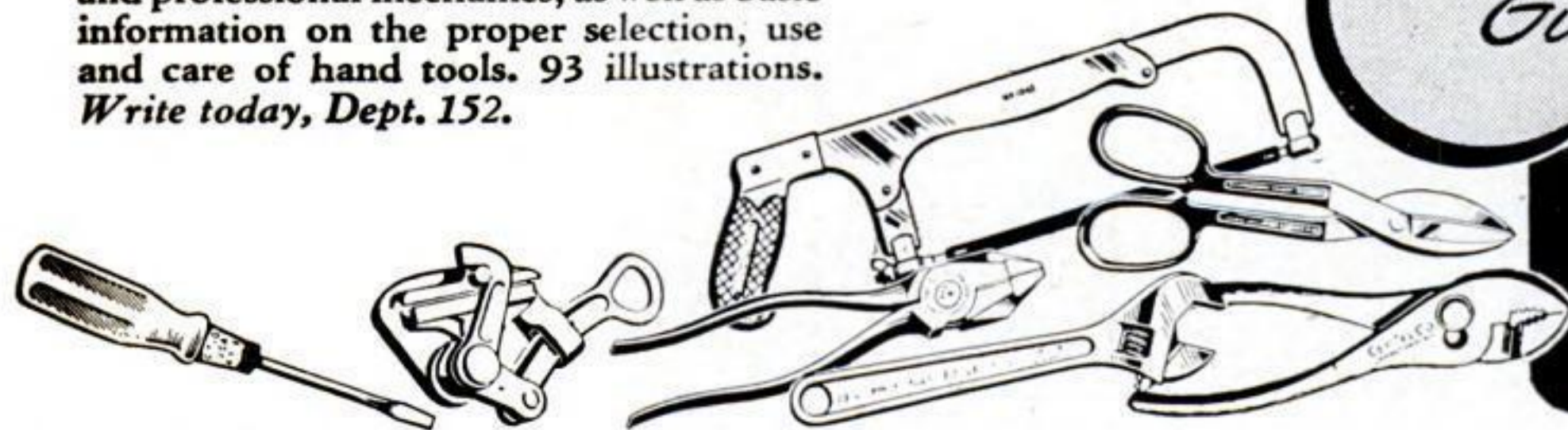

Crescent is our trade-mark, registered in the United States and abroad, for wrenches and other tools. Sold by leading distributors and retailers everywhere and made only by
CRESCENT TOOL COMPANY, JAMESTOWN, NEW YORK

JANUARY 1952 5



The Magic of Mind

WERE the great personages of the past victims of a stupendous hoax? Could such eminent men of the ancient world as Socrates, Pericles and Alexander the Great have been deluded and cast under the spell of witchcraft—or did the oracles whom they consulted actually possess a mysterious faculty of foresight? That the human mind can truly exert an influence over things and conditions was not a credulous belief of the ancients, but a known and demonstrable fact to them. That there exists a wealth of infinite knowledge just beyond the border of our daily thoughts, which can be aroused and commanded at will, was not a fantasy of these sages of antiquity, but a dependable aid to which they turned in time of need.

It is time you realized that the rites, rituals and practices of the ancients were not superstitions, but super-fuges to conceal the marvelous workings of natural law from those who would have misused them. Telepathy, projection of thought, the materializing of ideas into helpful realities, are no longer thought by intelligent persons to be impossible practices, but instead, demonstrable sciences, by which a greater life of happiness may be had.

One of America's foremost psychologists and university instructors, says of his experiments with thought transference and the powers of mind—"The successes were much too numerous to be merely lucky hits and one can see no way for guessing to have accounted for the results." Have you that open-minded attitude of today which warrants a clear, positive revelation of the

facts of mind which intolerance and bigotry have suppressed for years? Advance with the times; learn the truth about your inherited powers.

Let this free book explain

The Rosicrucians (NOT a religious organization) have been leaders in introducing the ancient wisdom of mental phenomena. Established throughout the world for centuries, they have for ages expounded these truths to those thinking men and women who sought to make the utmost of their natural faculties. Use the coupon below—avail yourself of a pleasing book of interesting information which explains how you may acquire this most unusual and helpful knowledge.

The ROSICRUCIANS (AMORC)

USE THIS COUPON

Scribe: C.S.T.
The Rosicrucians, AMORC
San Jose, California

I am sincerely interested in knowing more about this unseen, vital power which can be used in acquiring the fullness and happiness of life. Please send me, without cost, the book, "THE MASTERY OF LIFE," which tells me how to receive this information.

Name _____

Address _____ State _____

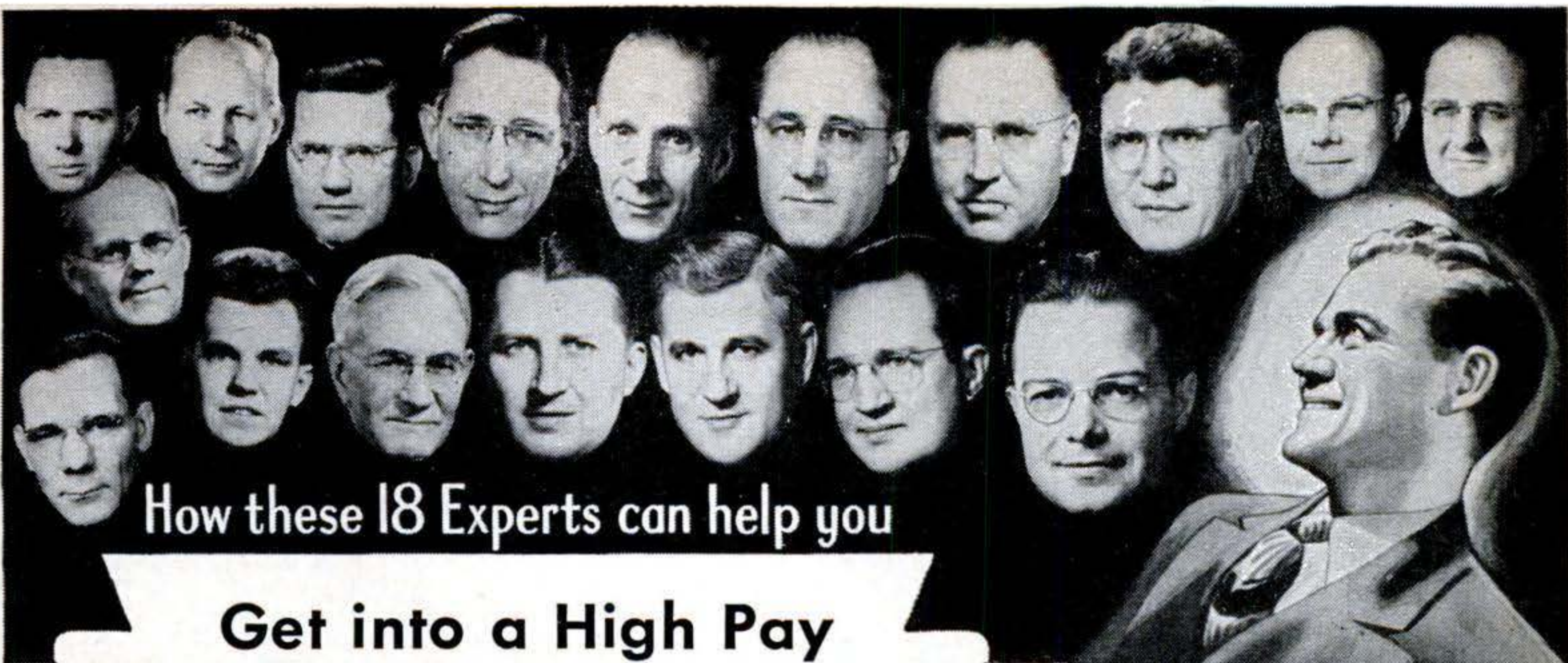

How these 18 Experts can help you

Get into a High Pay ACCOUNTING CAREER

LaSalle's famous staff of Accounting authorities are helping thousands prepare for fast promotions and bigger pay. They can do the same for you!

If your heart is set on a larger income and all that it means . . . better home—fine car—larger bank account—more of the good things of life. . . .

If that's your ambition and you are really serious about it, then you owe it to yourself to get the REAL FACTS about Accountancy, and the many good-pay opportunities that can be YOURS through LaSalle's famous Problem Method plan.

It matters not whether you've had a single day of experience in this field—or whether you have already started but want to climb higher. LaSalle's expert training is designed to take you *from where you are . . . to where you want to be . . .* in higher positions and a lifetime career of security and good income.

WHY YOU CAN'T FAIL TO GAIN

You see on this page a panel of experts who know Accounting from A to Z . . . all the way from simple bookkeeping, on up through advanced accounting, cost accounting, auditing, income tax, and coaching for the C.P.A. degree. These are only part of LaSalle's instruction staff. But what is most important to you . . .

... THESE C.P.A. EXPERTS KNOW HOW TO IMPART THEIR KNOWLEDGE TO OTHERS... HOW TO HELP YOU PREPARE QUICKLY YET THOROUGHLY FOR SUCCESS IN THIS VERY LUCRATIVE FIELD

The proof? What stronger proof could there be than



more than 3,500 Certified Public Accountants (approximately 10% of the U.S. total) who have trained with LaSalle? Or the hundreds of thousands of men and women whom LaSalle has helped qualify rapidly for more money, a brighter future, in a high-pay-lifetime career? These thousands came to us with different backgrounds of experience and varying degrees of ambition. Many have reported raises and promotions after only a few weeks of training. Thousands of them have written to say they are now earning 50% more—even *double* their former incomes—often in less than a year. These letters are published in book form for your inspection. They were written by real people, with real income, problems and ambitions—people who might be your next-door neighbor.

Yes, if you are really sincere in wanting to better your position—start your income climbing—enjoy a lifetime career of high standing and high reward—this friendly staff of experts can help you.

SEND FOR FREE SAMPLE LESSON... ALSO BIG 48-PAGE BOOK OF LATEST INFORMATION ABOUT CAREER OPPORTUNITIES

You don't have to wonder what LaSalle's Accountancy plan is like. You will be sent a free sample lesson, which does not obligate you in any way. Study it—keep it—see for yourself how simple, clear, and easy it is to master. This is an actual lesson right out of the regular training—to show you exactly how LaSalle's Problem Method has trained more than 1,275,000 men and women from all walks of life.

Also . . . the 48-page book, "Accountancy, the Profession That Pays," gives all the latest facts about the new and growing opportunities in five different fields of profitable employment.

This can be an important day in your life. A coupon like the one below has started hundreds of thousands of men and women toward a bigger job, a larger income. It can do the same for you.

Mail the Coupon Today!

LA SALLE
EXTENSION UNIVERSITY
A Correspondence Institution
417 S. Dearborn St., Dept. 183-H, Chicago 5, Ill.

Send free Sample Lesson in Accounting—also, 48-page free book, "Accountancy, the Profession That Pays" . . . all without cost or obligation.

FREE 48-PAGE CATALOG

FREE SAMPLE LESSON

Name.....Age.....

Address.....

City & Zone.....State.....

HIGHER ACCOUNTANCY
By the LaSalle Problem Method
Practical Accounting
Assignment 1
THE BALANCE SHEET

LaSalle Extension Univ.

An Amazing Invention — "Magic Art Reproducer"

DRAW The First Day **NO LESSONS! NO TALENT!**

**You Can Draw Your Family, Friends, Anything From REAL LIFE—
Like An Artist... Even if You CAN'T DRAW A Straight Line!**

**Anyone can Draw With This
Amazing New Invention —
Instantly!**



Complete for only
\$198

Also Copy Any Picture — Can Reduce or Enlarge Any Picture!
Yes, anyone from 5 to 80 can draw or sketch or paint anything now... the very first time you use the "Magic Art Reproducer" like a professional artist — no matter how "hopeless" you think you are! It automatically reproduces anything you want to draw on any sheet or paper. Then easily and quickly follow the lines of the "picture image" with your pencil... and you have an accurate original drawing that anyone would think an artist had done. Also makes drawing larger or smaller as you wish. Anyone can use it on any desk, table, board, etc. — indoors or outdoors! No other lessons or practice or talent needed!

Have fun! Be popular! Everyone will ask you to draw them. You'll be in demand! After a short time, you may find you can draw well without the "Magic Art Reproducer" because you have developed a "knack" and feeling artists have — which may lead to a good paying art career.

FREE!

"Simple
Secrets of
Art Tricks
of the Trade"

This valuable illustrated guide is yours FREE with order of "Magic Art Reproducer." Easy ABC art tricks that anyone can follow on different techniques, effects, proportions, perspectives, shading, color, animated cartoons, human figures to use with "Magic Art Reproducer" for added touches to your drawings.

**SEND NO MONEY!
Free 10-Day Trial!**

Just send name and address. Pay postman on delivery \$1.98 plus postage. Or send only \$1.98 with order and we pay postage. You must be convinced that you can draw anything like an artist, or return merchandise after 10-day trial and your money will be refunded.

**NORTON PRODUCTS, Dept. 441A
296 Broadway, New York 7, N. Y.**

**ALSO EXCELLENT FOR EVERY OTHER
TYPE OF DRAWING!**

• Human Figures



• Copy all cartoons, comics



• Outdoor Scenes, landscapes, buildings



• Copy photos, other pictures, portraits, etc.



• Still life, vases, bowls of fruit, lamps, furniture, all objects



• Copy designs, blueprints, decorations, etc. for woodwork, machine, for needlework, crocheting, knitting

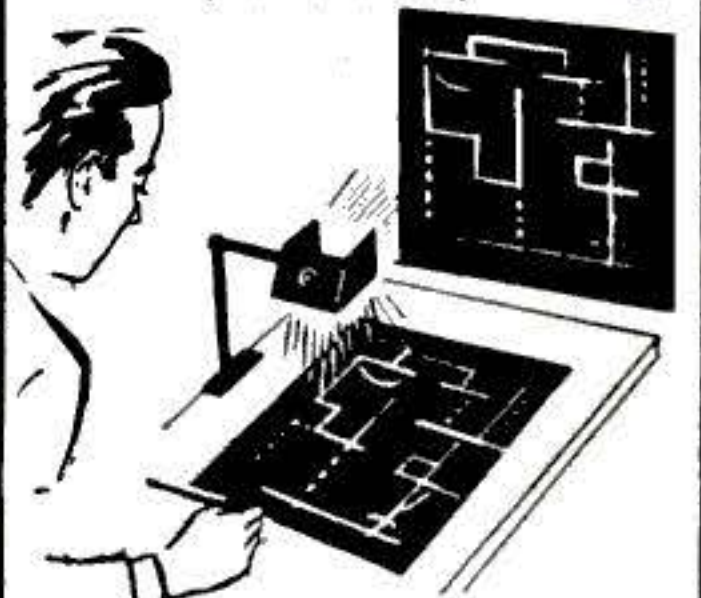

FREE 10-DAY TRIAL COUPON!

**NORTON PRODUCTS, Dept. 441A
296 Broadway, New York 7, N. Y.**

Rush my "Magic Art Reproducer" plus FREE illustrated guide *Simple Secrets of Art Tricks of the Trade*. I will pay postman on delivery only \$1.98 plus postage. I must be convinced that I can draw anything like an artist, or I can return merchandise after 10-day trial and get my money back.

Name.....

Address.....

City & Zone..... State.....

Check here if you wish to save coupon by sending only \$1.98 with coupon. Same Money Back Guarantee!

HERE'S A READY-MADE FUTURE FOR YOU

MILLIONS OF HOMES IN U.S. HAVE 6-12 SMALL APPLIANCES YEAR. -MILLIONS MORE SOLD EVERY YEAR. -MILLIONS NEED REPAIR NOW WITH THE NEED INCREASING DAILY!

Start Your own Business IN

ELECTRICAL APPLIANCE REPAIRING

EARN WHILE YOU LEARN

"Only had your course a few short weeks and have already made \$800.00". J. D. S., St. Louis, Mo.

"I work day times at the shipyard and after 4:00 P.M. I operate from my cellar and garage. I average \$10.00 to \$15.00 clear every day". W. H., Brookline, Mass.

"Make \$15.00 Saturdays and more. Am only able to operate in my spare time. It is just what a mechanically minded man needs". G. O. F., Thomasville, Ga.

3 EASY STEPS

- 1 We send you the "CHRISTY" Electronic Kit. A multi-purpose trouble tracer. Indicates current consumption, shorts, breaks, etc.
- 2 We teach you Electrical Appliance Repairing with cross indexed Illustrated Manuals. The Easy-To-Remember-Way.
- 3 We show you How to Get Business and Keep Business Coming to you.

IN YOUR OWN KITCHEN, BASEMENT OR GARAGE

LEARN at home in your spare time this fascinating big paying profession.

If you are mechanically inclined, can hold and use tools, we can give you the training and time saving kits that will enable you to . . . Command More Money At Work . . . A Better Paying Job Elsewhere . . . Or A Business Of Your Own!

New Shop Method Home Training teaches you both the technical and practical side of Electricity by having you work with your hands, Building, Testing, Repairing. All instruction manuals are written in easy-to-understand language, chock full of hundreds of detailed photos and drawings. We show you how to quickly locate the trouble, how to fix it and what to charge. ALSO, how to do House Wiring, Welding, Nickel Plating, Sharpen Lawn Mowers, Skates, etc. and how to build power tools you need from spare parts.

\$5.00 TO \$6.00 AN HOUR

Often charged for making ordinary repairs. We show you how to repair refrigerators, vacuum cleaners, washing machines, motors, etc.

WE GIVE YOU THIS ELECTRONIC KIT TROUBLE FINDER

SEND FOR FREE BOOK!

CHRISTY TRADES SCHOOL., Dept. D-1101
4432 N. Kedzie Ave., Chicago 25, Ill.

Please send me FREE Illustrated Book on Electrical Appliance Repairing and special form for paying later from earnings.

NAME.....Age.....

ADDRESS.....

CITY.....Zone.....State.....



Makes \$10

Shop Specializes in Television



\$5 to \$8 Week In Spare Time



Calls N.R.I. His "Stepping Stone"

BE A SUCCESS IN RADIO- Learn by Practicing

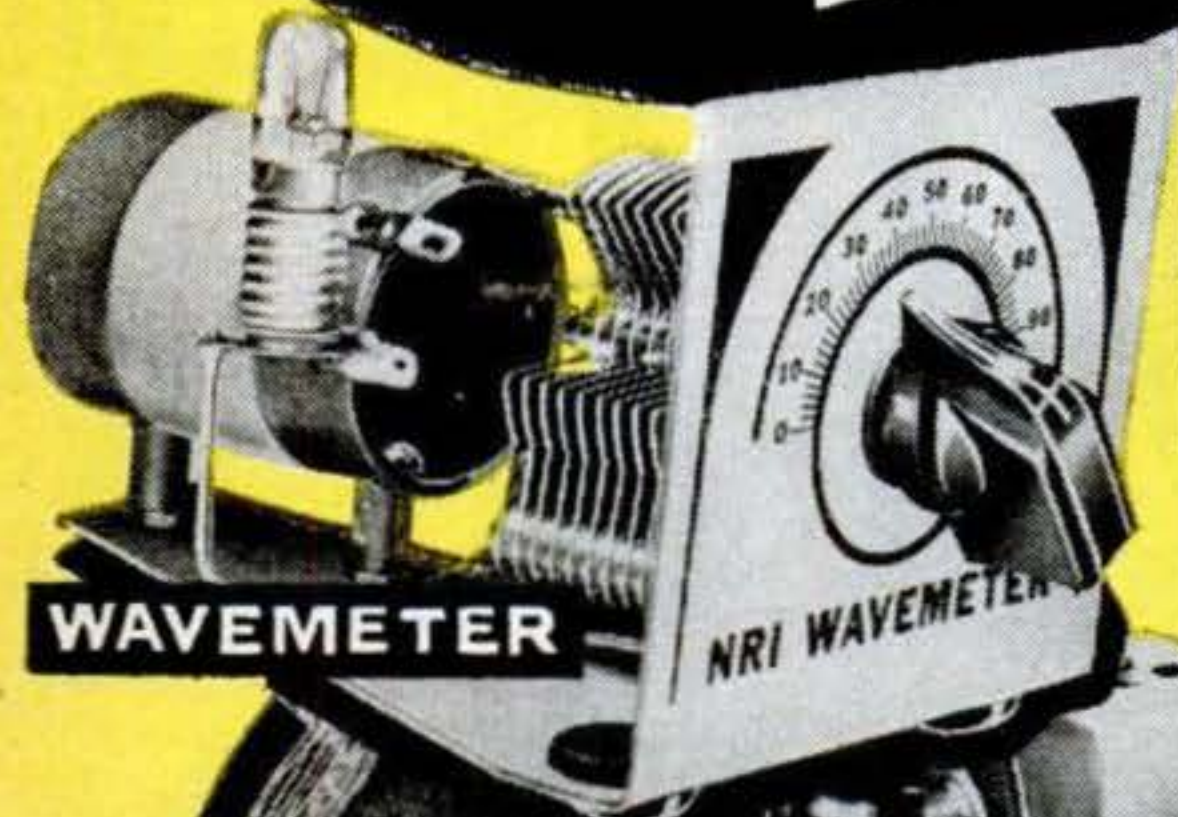

WAVEMETER



MODERN RADIO

Build Equipment Like This With Kits I Send You

I give you PRACTICAL EXPERIENCE with many Valuable Kits I send that "bring to life" my illustrated texts. In my Servicing Course, you build a modern Radio, Set Tester, AM Signal Generator, etc. In my Communications Course, you assemble a low-power Broadcasting Transmitter, Wavemeter, Electronic Multitester, etc. Some equipment from both the courses is shown on this page. All of the equipment that you build is yours to keep.



NEW! Advanced Television Practice!

New, special TV kits furnished to build high-definition SCOPE . . . RF OSCILLATOR with flyback power supply . . . complete TV SET . . . many other units. You see pulse, trapezoidal, saw-tooth wave forms. Get valuable PRACTICAL EXPERIENCE locating and correcting TV troubles. Mail coupon for facts, pictures and prices!

MAKE EXTRA MONEY WHILE LEARNING

I show you how to earn \$5, \$10 a week, or more in spare time fixing Radios. I send you parts to build the SET TESTER you use to do it. Frank Lhotsky, Cicero, Ill., above, one of my many students who earned while training, writes, "when I enrolled, I didn't know the difference between a power transformer and a condenser. Your outstanding course made a new, prosperous man of me."



TRANSMITTER

MULTITESTER



**NRI-
Graduate
Doubles
Salary**

"I am employed by Station WKDO as transmitter operator. Have more than doubled salary since starting in Radio full time."—A. Herr, New Cumberland, Pa.



**Manager
Radio and
Television
Dept.**

"From Radio and Television Technician . . . was promoted to Manager of Television Service and Installation. Thanks to N.R.I."—L. Hauger, San Bruno, Calif.



**Gets
First Job
Through
N.R.I.**

"My first job was operator with KDLR, obtained for me by your Graduate Service Dept. Am now Chief Engineer Police Radio Station WQOX."—T. S. Norton, Hamilton, Ohio.

**I TRAINED
THESE MEN**



TELEVISION

at Home in Spare Time

**Get a Good Job--Have a Bright Future
in America's Fast Growing Industry**

Do you want good pay, a job with a bright future and security? Would you like a profitable shop of your own? The fast-growing, prosperous RADIO-TELEVISION industry is making these opportunities for you. Radio alone is bigger than ever. 81 million homes and auto Radios, 2,700 Broadcasting Stations, expanding use of Aviation and Police Radio, Micro-Wave Relay, Two-Way Radio for buses, taxis, etc., are making opportunities for Servicing and Communications Technicians and FCC-Licensed Operators.

**Television is TODAY'S Good
Job Maker**

In 1946 only 6,000 TV sets sold. In 1949 almost 3,000,000. By 1954, 20,000,000 TV sets will be in use, according to estimates. 100 TV Stations are operating in 35 states. Authorities predict there will be 1,000 TV Stations. This means new jobs, more jobs, good pay for qualified men.



**WANT A BUSINESS
OF YOUR OWN?**

Let me show you how to have a good, steady income from your own Radio-Television shop. Many N.R.I.-trained men each year start without capital, like Robert Dohmen, New Prague, Minn., above. He writes, "Am now tied in with two television outfits."



**EXTRA
PAY IN
ARMY,
NAVY, AIR FORCE**

Knowing Radio, TV, Electronics can help you get extra rank, extra prestige, more interesting duty at pay up to several times a private's base pay. You are also prepared for good Radio-TV jobs upon leaving service. Mail Coupon TODAY.

**Many Soon Make \$10 A Week
Extra in Spare Time**

Keep your job while training at home. Hundreds I've trained are successful RADIO-TELEVISION TECHNICIANS. Most had no previous experience; many no more than grammar school education. Learn Radio-Television principles from illustrated lessons. Get PRACTICAL EXPERIENCE—build valuable multimeter for conducting tests; also practice servicing Radios or operating transmitters—experiment with circuits common to Radio and Television. You keep all equipment. Many students make \$5, \$10 a week extra fixing neighbors' Radios in spare time. SPECIAL BOOKLETS start teaching you the day you enroll.



**FREE
ACTUAL LESSON
AND 64 PAGE BOOK**

Act Now! Send for my FREE DOUBLE OFFER. Coupon entitles you to actual lesson on servicing; shows how you learn Radio-Television at home. You'll also receive my 64-page book, "How to Be A Success in Radio-Television." You'll read what my graduates are doing, earning; see photos of equipment you practice with at home. Send coupon in envelope or paste on postal. J.E. SMITH, President, Dept. 2AB, National Radio Institute, Washington 9, D. C. OUR 38TH YEAR.

**MAIL
THIS
NOW**

Good For 2 Books FREE

**MR. J. E. SMITH, President, Dept. 2AB
National Radio Institute, Washington 9, D. C.**

Mail me Sample Lesson and 64-page Book about How to Win Success in Radio-Television. Both FREE. (No salesman will call. Please write plainly.)

NAME.....AGE.....
ADDRESS.....
CITY.....ZONE.....STATE.....

Approved Under G. I. Bill.

YOU SAVE UP TO 50% THORESEN'S CASH SAVEWAY!



NEW! SHOCK RESIST MODEL CHRONOGRAPH

You can buy plenty of "chronographs" for less money—but remember, Thoresen's is the only **GENUINE RECIPRO-REGISTER CHRONOGRAPH**, distributed exclusively by us in the U.S. A magnificent watch, it also times Races, Planes, Sports, Photography, Shop Work, etc. **INCABLOC** 17 jewel movement resists shocks and rough handling that may ruin other watches. 5 multi-function synchronized dials. Contact clutch starts computation. Brake clutch freezes result. Also **ERASES** back to zero and **REMEMBERS** for you while movement continues to keep time! Stainless Steel back, radium dial, unbreakable crystal, etc. Get the one and only genuine. Not \$100.00. Now only \$27.25 plus 10% tax, total \$29.98. Nationally advertised **Cobra Metal Band** (reg. \$3.95) **FREE** of extra cost!



POWERFUL LONG RANGE GERMANY

AMAZING VAL- \$2.95
UEI Compare with domestic binoculars selling up to \$9.95, for clarity, light weight, rugged construction! **GERMAN KLAROVIS** ground lenses give terrific magnification, wide field of view, and sharp, brilliant detail! Smooth, **SYNCHRONOUS** centre focusing mechanism. 40mm. objectives. **NEW!** Different! **CAUTION:** Do not confuse with crudely made binoculars claiming 18 mile ranges! You can depend on **GUARANTEED KLAROVIS QUALITY!** Manufactured by German Artisans. Only \$2.95.



NEW! JET-O-MATIC 360° AUTOMATIC

Superior De-Luxe model. **360° FULL SWING AUTOMATIC.** Just set it—then forget it! Winds itself as you wear it. Patented **INCABLOC**—17 Jewel movement of superb accuracy. **WATER & SHOCK RESIST**—drop it, bang it, even swim with it. 100% Stainless Steel Screw-back, radium luminous markings, unbreakable crystal, hairline sweep second, **SPLIT SECOND** calibrations for precise timing. Handsome **THIN** case. De Luxe **GOLD** tone numerals & hands. **CAUTION:** Do not confuse with inferior 180° **HALF** swing automatics! Thoresen's **JET-O-MATIC** is the **FULL SWING** self winder—**360° high compression!** Makes ordinary watches old fashioned by comparison. It's our **BEST** Automatic. Not \$75.00. Our price only—**24.95** plus 2.50 tax, total **27.45.**

LOOK! SAVE THORESEN'S CASH-SAVE-WAY!

Be smart! Don't pay **TWICE** as much for credit! Frankly, we'd have to charge you **DOUBLE** for time payments. By big-volume cash selling **DIRECT-TO-YOU**, we save credit "dead beat" losses, high pressure salesmen's commissions and fancy main street rentals. We pass on these savings to **YOU!** Result: You pay only 1/2 and pocket the difference!

10 DAY HOME TRIAL! Use at our risk, without obligation. If not delighted, return within 10 days for **QUICK** refund of price. **Save MORE**—send check or money order for prompt, **free** delivery. **C.O.D.'s** sent plus postage.

Unlimited Guarantee EXCLUSIVE OF PARTS Given with every watch! Never a charge for skilled labor, handling, adjusting, etc. for **LIFETIME** of this business! **NOTICE!** All Thoresen watches certified **BRAND NEW** and **TESTED** before shipment. We never sell "second hand" or surplus watches! Be wise! Shop with 100% safety the **Thoresen—SAVE** way! For **HONEST** values, write now!
Thoresen Direct Sales
 Dept. 7-A, 131 West 33rd St.,
 New York 1, N. Y.



Original TRANS-KLEER PORTABLE GARAGE \$10

PROTECT YOUR CAR against the ravages of snow, sleet, rain, salt air, grime and dust with a genuine, **ORIGINAL TRANS-KLEER** garage! It's different... it travels with your car everywhere. Whisks on and off quick and easy! Takes little storage. Folds away like a handkerchief. Unique, elasticized **GRIP-PLEAT** bottom offers complete security, winter or summer. Pays for itself many times over. Protects car finish and keeps water out of motor. Saves on car washes too!
Compare TRANS-KLEER with any Garage up to \$19.95 Do not confuse **TRANS-KLEER** with inferior plastic materials! Thoresen's Portable Garage is quality made of **100% HEAVY DUTY TRANS-KLEER**, a miracle of American industry! It's **THICK** and **TOUGH**, yet so **SILKY!** Resists cracking or peeling even in coldest weather! **Live-Flex** action means long life. **TRANS-KLEER** is our very **BEST QUALITY**, longest wearing garage. Tailored in **ALL** sizes for **ANY** car, from an Austin to a Cadillac to ensure better fitting. Thoresen's unique **GRIP-PLEAT** bottom allows you to use it for **Farm Machinery, Tractors, Garden Furniture, Small Boats** and other equipment. Send only \$10 for **FREE** prompt delivery right up to your door. No collect charges for expressage or postage! Or order **C.O.D.** plus postage. In either case, **TRY IT 10 DAYS AT OUR RISK!** Your \$10 back **QUICK** if not delighted. Mention car make, year and model!

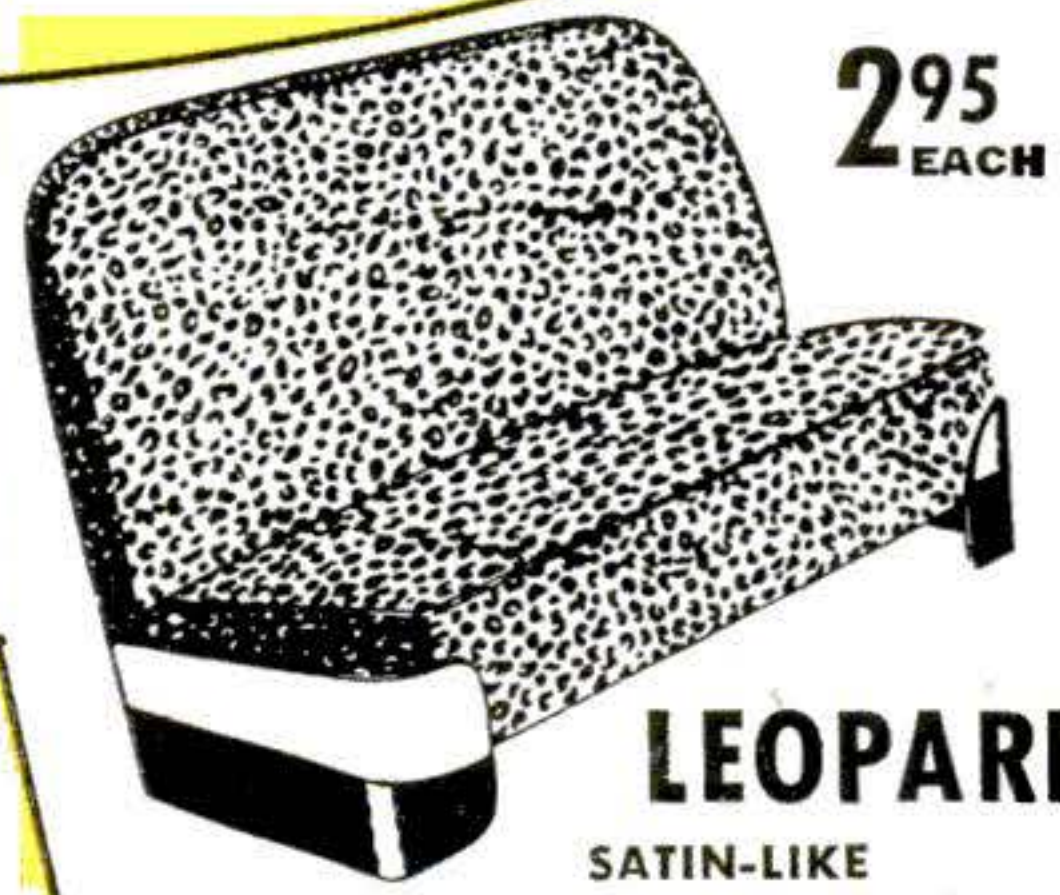

LEOPARD SATIN-LIKE "RICH-TONE" DESIGN AUTO SEAT COVERS

TERRIFIC VALUE! New, deluxe **RICH-TONE** material looks like **LEOPARD FUR**, gives beauty and distinction to your car. Adds new life to old, worn interiors. Protects new car upholstery against wear, dust, grime, stains, grease, bad weather. Tough, durable, resists cracking! Handsome tailored appearance. For **ALL** cars, **ALL** years, **ALL** makes and models. No pins! No tacks! No sewing! Ingenious **SNAP-TITE** feature. Just **SNAP** on or off in a **JIFFY!** Best of all: they're only **2.95** for front or rear seat. **SPECIAL!** Pair for front and rear, only **4.95.** Mention car make, model & year, also if front seat is full front or split coupe front.

THRIFTY BUYS

- 17 JEWEL STANDARD CHRONOGRAPH** (3 dials — 5 hands) our price **18.95** plus 1.90 tax
- 17 JEWEL AUTOMATIC (180° HALF SWING Model)** our price **19.50** plus 1.95 tax
- HEAVY DUTY PLASTIC PORTABLE GARAGE** our price **8.69** no tax
- SPECIAL! MEN'S SWISS ACCURATE WATCH** our price **4.69** plus 47c tax
- 17 Jewel INCABLOC WATER & SHOCK RESIST** our **LOWEST** price ever! only **14.50** plus 1.45 tax

Send all orders to old reliable:

THORESEN DIRECT SALES, Dept. 7-A, 131 West 33rd Street, New York 1, N.Y.

THESE MEN ARE GETTING PRACTICAL TRAINING IN **ELECTRICITY**

On Real:

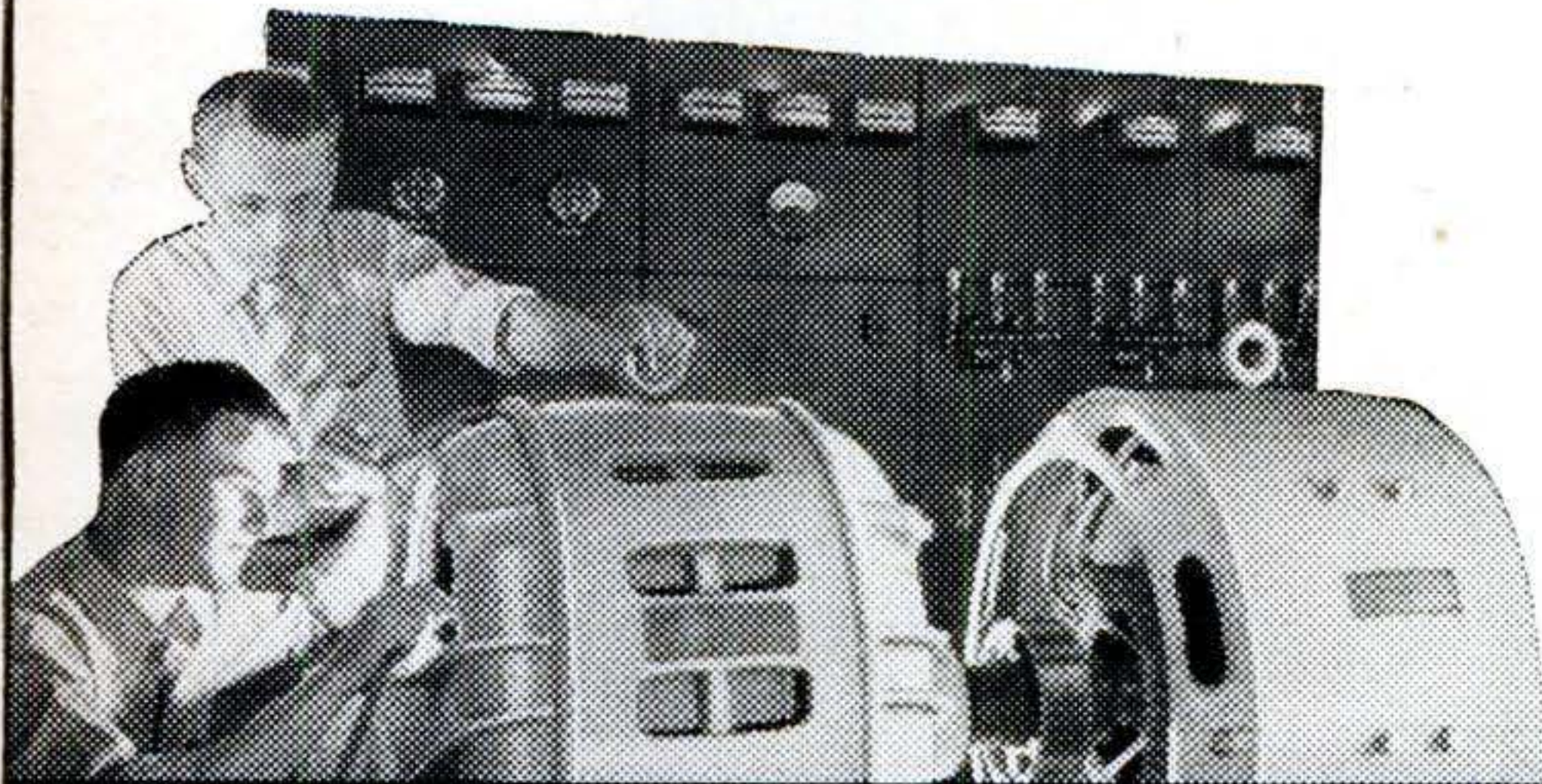

**A.C. and D.C. MOTORS
GENERATORS
SWITCHBOARDS
CONTROLLERS
WIRING JOBS
APPLIANCES
ELECTRONIC UNITS**

(Shown at left—Instructor explaining operation and testing of a large Motor Generator in our A.C. Department.)

AND **TELEVISION-RADIO**

On Real:

**TELEVISION SETS
RADIO RECEIVERS
F.M.
(Frequency Modulation)
RECORD CHANGERS
AUTO RADIOS
PUBLIC ADDRESS Systems**

(Right—Instructor helping students check the wiring and trace circuits of television receivers.)



TRAIN QUICKLY in the Great Shops of COYNE for VITAL FIELDS

ELECTRICITY—RADIO—TELEVISION—ELECTRONICS—VITAL in defense program. Trained men whether 16 or up to 50 needed. TRAIN QUICKLY for better rating if drafted—Vital job in industry if not.

FINANCE PLAN for non-veterans. G. I. Approved. Special plan for men of draft age.

NOT "HOME-STUDY" COURSES! At Coyne you learn on real, full-size equipment. Trained instructors show you how, then you do typical jobs yourself. We don't teach by mail.

CLIP COUPON NOW for big new illustrated Coyne book. Check whether interested in ELECTRICITY or TELEVISION-RADIO or both. No obligation; no salesman will call. Get vital facts now!

B. W. COOKE, President



COYNE SCHOOL

**A TECHNICAL TRADE INSTITUTE
CHARTERED NOT FOR PROFIT
Established 1899
500 S. Paulina Dept. 12-73H
Chicago 12, Illinois**

ELECTRICITY ★ TELEVISION ★ RADIO ★ REFRIGERATION ★ ELECTRONICS

**Mail Coupon for
BIG FREE BOOK!**



B. W. COOKE, President
COYNE SCHOOL

500 S. Paulina St., Chicago 12, Ill. Dept. 12-73H

Send BIG FREE book and details of your training offer. This does not obligate me and no salesman will call. I am interested in:

ELECTRICITY TELEVISION-RADIO

NAME

ADDRESS

CITY.....STATE.....



Atomic Air Train?

I read your article on atomic-powered aircraft [Oct. '51, p. 98] with interest.

You point out that the heavy power plant and entrained apparatus will about offset the advantage gained by fuel-tank elimination. But if the craft has unlimited range and unlimited power, at low amortized costs, then the answer would appear to be very simple: namely, just install the atomic power plant in a towplane, which need be only large enough to house it, and then use the towplane to haul a glider train.

OWEN BROWN, Los Angeles

Duller Cars, Not Drivers

In your story on one of the new cars Wilbur Shaw says: "I got an excess amount of reflection from the surface of the shelf behind the windshield. It had an enamel-like black finish. Automobile manufacturers ought to dull-finish all such surfaces in the interest of safer driving."

AMEN!

FRED A. COVEY, Berkeley, Calif.

The Wild, Tiled Wilderness

Senator Richard L. Neuberger, in your November issue ["Engineers Invade Another Wilderness," p. 98], has written the finest, most factual and comprehensive article I have ever read in an American publication concerning Canada, and particularly British Columbia's industrial progress in the last 10 years.



It's not all bear, moose and water power that we have up here. That's why we appreciate his reference to tile swimming pools.

ROSS S. THOMPSON, Vancouver, B. C.

Warm Welcome

I'd like to compliment you highly for the excellent treatment you gave the article on

"How a Thermostat Tends Your Furnace" [Nov. '51, p. 148].

It is, to my knowledge, the first time anyone has translated the operation of a thermostat into such easily understood terms.

JOHN F. BUDD, JR., New York City

Norwegians Got Nuthin on Us

The October issue [page 103] has a picture of two Norwegian students riding in a Model T Ford with the tires filled with straw.

Well, sir, to some of us fellows the idea is not very new. In 1929, I had a Buick touring car, and seven of us were on our way back to Chicago after spending a week end at a lake.



Our tires were good, but the tubes were bad, and we had two flats. The tubes were beyond patching, and we had no spare. We could not buy any tubes that size, so we stuffed the tires with grass. We rode about 20 miles and had to stuff in more grass because it was drying out. After the second stuffing, we got home okay and rode around on those tires for two weeks until we replaced the grass with new tubes.

WM. HODOVAL, Chicago

Warning on Burning Batteries

May I add a precaution to your suggestion that old flashlight cells be burned in a fireplace to prevent formation of soot [Nov. p. 151].

Some flashlight cells are made with a complete metal covering. If this sealed type is put in the fire, gas pressure builds up until they pop. I had this happen in my furnace. In a fireplace, it could scatter ashes or burning embers around the room. Better put this type in the ash can.

BOB GLAESER, Cleveland

Our item should have specified batteries of the non-sealed type.

How to Clean a Carb

In your November 1951 issue, page 190, there appears the statement: "These [var-

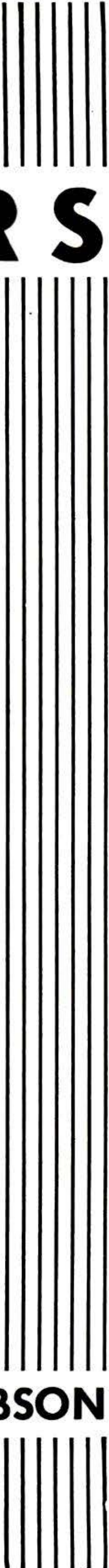

INVENTORS

Learn how to protect your invention. The U. S. Patent Laws provide that any new and useful art, machine, article of manufacture, or composition of matter, or any new and useful improvement thereof, may be patented if the act of invention is involved. Therefore, every inventor with a valuable invention should take advantage of the Patent Laws and proceed for patent protection in order to safeguard his rights.

A patent gives the inventor the exclusive right to prevent others from making, using, or selling the invention claimed in the patent for a period of seventeen years.

The Patent Laws were enacted for the benefit of the inventor to give him protection for the features of his invention which are patentable. These features must be properly and concisely set forth and claimed in a formal application for patent, in order to comply with the requirements of the Patent Laws. For that reason, unless the inventor is familiar with patent matters, he should engage a competent registered patent attorney or agent to represent him. We are registered to practice before the U. S. Patent Office and are prepared to serve you in the handling of your patent matters.

A specially prepared booklet entitled "Patent Guide for the Inventor", containing detailed information with respect to patent protection and procedure, together with a "Record of Invention" form will be promptly forwarded to you without obligation upon request.

CLARENCE A. O'BRIEN & HARVEY JACOBSON

Registered Patent Attorneys

22 - A DISTRICT NATIONAL BUILDING

WASHINGTON 5, D. C.

JANUARY 1952 15

BECOME AN Electrical Engineer



- Major in Electronics or Power
- B.S. Degree in 36 months
- Technician Certificates in 12 to 18 months

FOLLOW THIS PLAN

By 1954 there will be at least two positions for every engineering and technician graduate. Enter these opportunities early . . . earn your B.S. Degree in 36 months through optional year 'round study.

RADIO-TELEVISION TECHNICIANS are needed throughout America's fastest growing industry. You become a Radio Technician in 12 months. In 6 additional months become a Radio-Television Technician. These Technician Courses are complete in themselves but can be applied as one-third of the B. S. Degree program.

Military, Practical, or Academic training evaluated for advanced credit. Faculty of specialists. Over 48,000 former students from all states and 23 overseas countries. Nonprofit school in its 49th year.

Choose from these courses:

SERVICE 6 months

- Electricity
- Welding
- Refrigeration
- Heating
- Preparatory

TECHNICIAN 12 to 18 months

- Radio and Television
- Electronics
- Electrotechnics (Power)
- Welding
- Air Conditioning

ENGINEERING 36 months

- Electrical Engineering — B. S. Degree. Major in Electronics or Power.

MILWAUKEE SCHOOL OF ENGINEERING

TERMS OPEN APRIL, JULY, OCTOBER, JANUARY

Write for free 110-page catalog, 48-page pictorial booklet "Your Career" and "Occupational Guidance Bulletins."

MILWAUKEE SCHOOL OF ENGINEERING
Dept. PS 152, 1025 N. Milwaukee,
Milwaukee, Wisconsin

Without obligation send Catalog for Electrical Engineering, B. S. Degree, major in Electronics; Power; "Your Career"; Occupational Guidance Bulletin on: Radio-TV Electrical Power Welding Heating, Refrigeration, Air Conditioning.

Name _____ Age _____

Address _____

City _____ Zone _____ State _____

If veteran, indicate date of discharge _____



nish-like] deposits should be washed off [the automatic-choke linkage] every 5,000 miles with lacquer thinner. Most other solvents won't work."

Tests by independent laboratories and carburetor manufacturers have proven that Gumout, made by Pennsylvania Refining Company, Cleveland, completely removes, by chemical action, all gum, sludge, muck and other foreign matter that accumulate in carburetors.

HAROLD B. MONTGOMERY, Philadelphia

He Did It His Way

The tectihcra (a backwards architect) who designed the "Merry-Go-Round" to Park Cars" on page 164 of the October issue must have been sitting out in a snow-storm on a hot summer day watching a tail wag his dog when he thought up such an absurd idea.



Instead of rotating six floors with tons of parked automobiles on them, why doesn't he rotate the elevator with one to four cars on it?

HARLIN G. LOOMER, Philadelphia

Distant Dashboards Greener?

In his November article on the Minx [p. 124], Wilbur Shaw says: "Here are those battery and oil-pressure lights that we ought to see on more U. S. cars. . . A green light flashes if the oil pressure is low, a red light if the battery is on discharge."

A lot of British drivers don't agree. In fact they envy us for universally having ammeters and oil-pressure gauges on the dash. Recently the magazine *Motor*, which is practically a Bible for English autoists, complained about the "cheese-paring" of manufacturers who leave off these gauges to save money. They editorialized that the "warning lights as at present fitted to many British cars are by themselves neither trustworthy nor particularly desirable."

Sounds to me like one of those cases where the unfamiliar seems better, mostly because it is unfamiliar.

JACK BENNETT, Boston

INVENTORS

If you believe that you have an invention, you should find out how to protect it. The first step is to have a search made of the prior pertinent U. S. patents. If a report on this search indicates that the invention appears patentable you can apply for a patent, and the specifications and claims should be prepared.

The firm of McMorrow, Berman & Davidson, with offices in Washington, D. C., is qualified to take the necessary steps for you. We can make a preliminary search on your invention, advise you whether we think it can be patented, and prepare your application for patent.

Unless you are fully familiar with the U. S. Patent Laws, we recommend that you engage the services of a Registered Patent Attorney to protect your interests. The patent laws are *your* laws. A patent gives you the right to prevent others from making, using or selling the invention claimed in your patent for a period of 17 years.

Use these patent laws for your protection. Investigate whether your invention can be patented. If you have what you believe to be an invention, we suggest that you have this firm make a search for you.

Send for a copy of our Patent Booklet entitled "How To Protect Your Invention," containing information about patent protection and patent procedure. Along with this we will also send you an "Invention Record" form, for your use in writing down and sketching details of your invention. We will mail them promptly. No obligation. They are yours for the asking.

McMORROW, BERMAN & DAVIDSON

Registered Patent Attorneys

PATENTS • COPYRIGHTS • PATENTS

1422 VICTOR BUILDING, WASHINGTON 1, D. C.

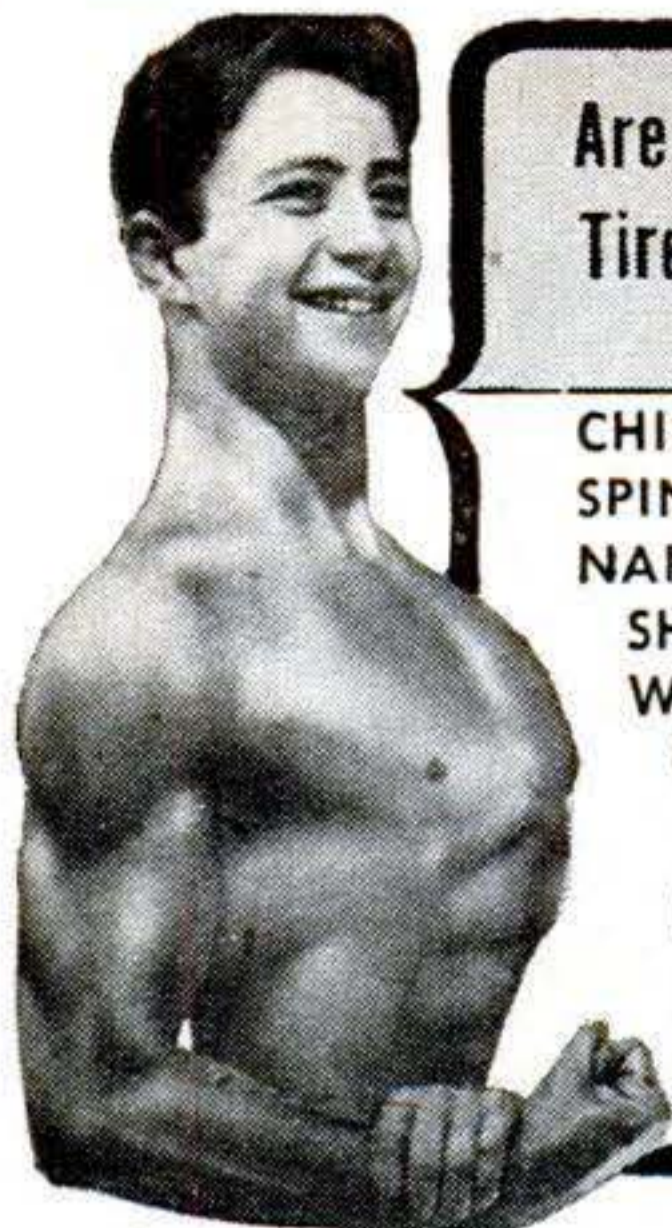

ROGER HIRSCH was an 112 lb. 6 ft. weakling LOOK AT HIM NOW!

Aren't YOU as SICK and Tired as I was of being SKINNY-

CHICKEN-CHESTED
SPINDLE-ARMED
NARROW-SHOULDERED
SHORT-WINDED
WEAK, HALF-ALIVE
GIRL-SHY

Then do as I did . . .
MAIL THE COUPON BELOW
I gained 53 lbs. of mighty muscle
I added 6½ in. to my CHEST
3 inches to each ARM
ALL IN A FEW
SHORT WEEKS

YOU can WIN this 15" Silver trophy as Roger just did



Come on, PAL, Now YOU give me 10 pleasant Minutes a Day...& I'll give you a NEW HE-MAN BODY for your OLD SKELETON FRAME.

says GEORGE F. JOWETT

—World's Greatest Builder of HE-MEN

NO! I don't care how skinny or flabby you are; if you're a teenager, in your 20's or 30's or over; if you're short or tall. Give me JUST 10 EXCITING MINUTES in your home to MAKE YOU OVER by the SAME METHOD I turned myself from a wreck to a Champion of Champions. YES! You'll see INCH upon INCH of MIGHTY MUSCLE added to YOUR ARMS, Your CHEST deepened. Your BACK AND SHOULDERS broadened. From head to heels, you'll become an All-Around, All-American HE-MAN, a WINNER in everything you tackle—or my Training won't cost you one cent! Develop YOUR 520 MUSCLES . . . Gain Pounds, INCHES, FAST! Friend, my "5-WAY PROGRESSIVE POWER" is best by test—the only method that builds you 5-ways fast. You save YEARS, DOLLARS like MANY THOUSANDS like you did. so . . . MAIL COUPON NOW

Builder of CHAMPS

4 times WINNER PERFECT MAN CONTEST



FREE if you mail COUPON NOW
1. MUSCLE METER
2. JOWETT'S Photo Book of Famous Strong Men—
"Nerves of Steel, Muscles of Iron," packed with photos of miracle he-men whom Jowett guided from weaklings to muscular power. Read thrilling adventures of Jowett, himself. Mail Coupon NOW!

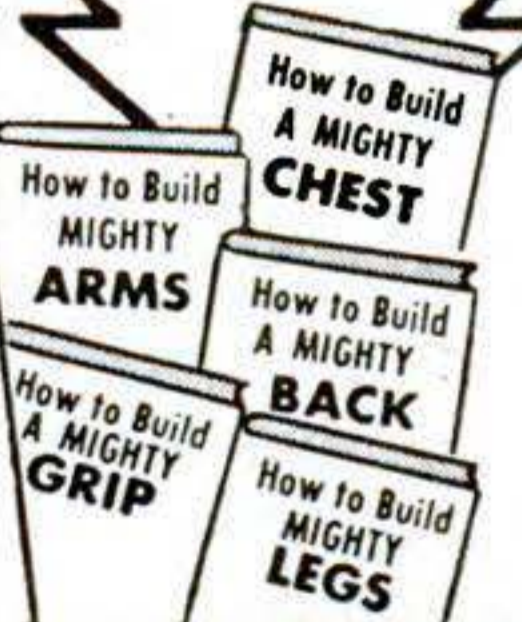

FREE Photo Book How to Achieve Nerves of Steel, Muscles of Iron

AMAZING ALL 5 Picture-packed courses while the supply lasts—only 10c MILLIONS SOLD at \$1 and more

FREE PHOTO BOOK of FAMOUS STRONG MEN

DEPT. PS-21

"Jowett Courses greatest in World for Building All-Around HE-MEN."
—R. F. Kelley
Physical Director

JOWETT INSTITUTE OF PHYSICAL TRAINING
230 FIFTH AVENUE, NEW YORK 1, N.Y.

Dear George: Please mail to me FREE Jowett's Photo Book of Strong Men, plus all 5 HE-MAN Building Courses: 1. How to Build a Mighty Chest. 2. How to Build a Mighty Arm. 3. How to Build a Mighty Grip. 4. How to Build a Mighty Back. 5. How to Build Mighty Legs—Now all in One Volume "How to Become a Mighty He-Man." ENCLOSED FIND 10c FOR POSTAGE AND HANDLING (No CO.D.'s).

Name..... Age.....
(Please print plainly)
Address.....
City..... Zone..... State.....

MIRACLE TOMATO Yields 2 BUSHELS To a Vine



Now—You can grow the world's most amazing Tomato right in your own garden and get from 2 to 3 bushels of delicious, ripe tomatoes from every vine.

BURGESS CLIMBING TRIP-L-CROP

TOMATO grows 16 to 20 feet high. Huge, meaty, solid fruit, wonderful flavor. Some weigh as much as 2 pounds each. Unsurpassed for canning and slicing. Blight free—drought and disease-resistant. Grows in any garden Outyields all other varieties.

TRIAL PACKET 10c

Postpaid. Order Today 3 Packets for 25c

Write for FREE complete Catalog listing many unusual Seeds Plants and Bulbs.

BURGESS SEED & PLANT CO.
107 B. Galesburg, Mich.

BIG MONEY for You Showing NEW MIRACLE Labor Saving Discovery

MEN! WOMEN! Enjoy amazing profits with new "Miracle" Copper Cote Ironing Pad. Plastic Coating saves housewives time, labor, money. 1-minute demonstration sells it. Experience unnecessary. Write for FREE Sample Offer Send for FREE facts about COPPER COTE, and our other new fast-selling products. SEND NO MONEY. Write for details, sample offer to THE SHELDON CO., Dept. 855 1223 South 23rd St., Milwaukee 46, Wis.



HYPNOTIZE

Yes. Anyone. Mystify Friends. Authentic fascinating hypnotic feminine photos show you precise spellbinding methods. Instructions reveal how easily speed hypnotism is accomplished. Become an expert hypnotist. Entertain. Self-hypnosis fully explained. Amazing results. Learn about intriguing newly developed science of mental therapy and learning while you sleep. Free catalog of new hypnotism books sent on request.

Send for the exciting illustrated book "HYPNOTISM REVEALED" → \$1
12" Phonograph Record Inducing Group-Hypnotism & Self-Hypnosis → \$5

MELVIN POWERS, Master Hypnotist, 1324 Wilshire, Dept. 85 Hollywood 17, Calif.

GO PLACES LEARN ANOTHER LANGUAGE EASILY - QUICKLY

IN 20 MINUTES A DAY by LINGUAPHONE

World's-Standard CONVERSATIONAL METHOD

FRENCH
SPANISH
GERMAN
RUSSIAN
CHINESE
—any of 29 Languages

Are interesting job, travel, armed services', cultural opportunities passing you by because you speak only one tongue? Learn AT HOME any of 29 languages including the ASIATIC—quickly, easily by LINGUAPHONE CONVERSATIONAL METHOD. YOU LISTEN—you learn—you understand—you SPEAK. World-wide educational endorsement: over a million home-study students. FREE BOOK gives fascinating facts. WRITE TODAY! Approved for VETERANS' Training.

LINGUAPHONE INSTITUTE

147-01 Radio City

New York 20, N. Y.

**NOW... GET EVERYTHING YOU
NEED TO LEARN AND MASTER**

TELEVISION

**RADIO-ELECTRONICS
...AT HOME!**

Use REAL commercial-type equipment to get practical experience

Your future deserves and needs every advantage you can give it! That's why you owe it to yourself to find out about one of the most COMPLETE, practical and effective ways now available to prepare AT HOME for America's billion dollar opportunity field of TELEVISION-RADIO-ELECTRONICS. See how you may get and keep the same type of basic training equipment used in one of the nation's finest training laboratories... how you may get real STARTING HELP toward a good job or your own business in Television-Radio-Electronics. Mail the coupon today for complete facts — including 89 ways to earn money in this thrilling, newer field.

D.T.I., ALONE, INCLUDES BOTH MOVIES and HOME LABORATORY In addition to easy-to-read lessons, you get the use of HOME MOVIES — an outstanding training advantage — plus 16 big shipments of Electronic parts. Perform over 300 fascinating experiments for

**Get BOTH of these
Information packed
publications FREE!**

**89 WAYS
TO
EARN
MONEY
IN TELEVISION
RADIO ELECTRONICS**

**YOU GET
D.T.I.**

practical experience. Build and keep real commercial-type test equipment shown at right

MODERN LABORATORIES

If you prefer, get all your preparation in our new Chicago Training Laboratories—one of the finest of its kind. Ample instructors, modern equipment. Write for details!

MILITARY SERVICE!

If you're subject to military service, the information we have for you should prove very helpful. Mail coupon today.

ACT NOW! MAIL COUPON TODAY!

DE FOREST'S TRAINING, INC. DEPT. PS-1-1
2533 N. Ashland Ave., Chicago 14, Ill.

Without obligation, I would like your Opportunity News Bulletin showing "89 Ways to Earn Money in Television-Radio-Electronics"; also, the folder showing how I may prepare to get started in this thrilling field.

Name..... Age.....
Address..... Apt.....
City..... Zone..... State.....

ABOVE: Build and keep a real 17 INCH commercial TV receiver. Optional after completing regular training at moderate added cost.

**Here's the
REAL THING!**

**SET UP YOUR OWN
HOME LABORATORY**

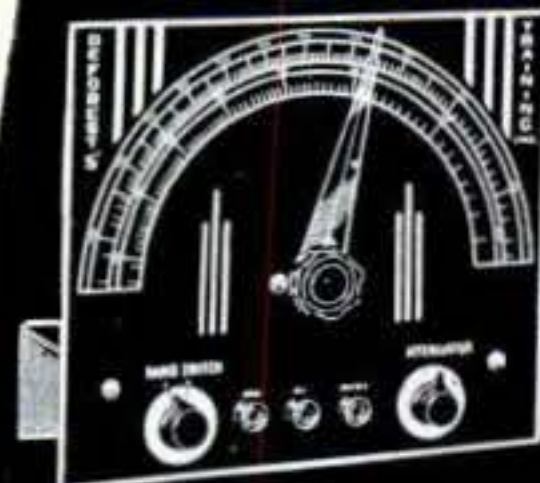

R-F Signal Generator



Oscilloscope

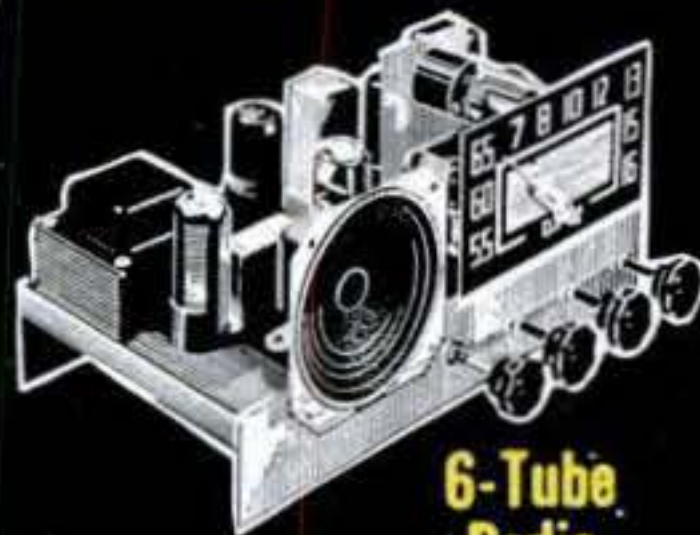

**6-Tube
Radio**



Multimeter



Home Movies

One of America's Foremost
Television Training Centers

De FOREST'S TRAINING, INC.
CHICAGO 14, ILLINOIS
A De VRY INSTITUTION

A forceful he-man voice
can bring you more
**SELF-CONFIDENCE
AND POISE!**

Let me show you
how I train new
LIFE into your
voice—to
improve your
earning power
and leadership

YES it's true! Now you can get ahead in business and social life to the limits of your ability—no longer need you be held back by a weak, apologetic voice that makes you "hide your light under a bushel."



SOLID VOICE

Use your **FULL** voice to get things done fast. People listen to and respect a hearty voice.



Success-Winning Voice

Dramatize your voice and you'll be more convincing. A strong voice aglow with enthusiasm is almost irresistible.

YOUR VOICE—AND YOUR PERSONALITY

A **virile** voice is a friend-winner and a success-magnet. People admire the man whose voice possesses calm, controlled power.



My aim is to put *backbone* into a normally weak voice. I make you *sound BIG* and effective...you talk with more volume, easily and comfortably, without straining because your voice is stronger.

TIME-TESTED METHOD
More than 125,000 students trained since 1916

The Feuchtinger Voice-Method has helped many famous actors and singers but I am more interested in the good we have done for businessmen, clergymen, teachers, lawyers, salesmen, executives, union officials, etc., etc.

The results my students achieve are very often **AMAZING!** These sensational benefits are reported by many men who, before they enrolled, didn't even realize they needed voice training!

FREE BOOK sent without any obligation

See for yourself why my method is so effective. Let me send you, in plain envelope, interesting information about how my home-study course can help you—in the privacy of your own room. Mail coupon below. No salesman will call. Perfect Voice Institute, 210 S. Clinton Street, Studio A-1, Chicago 6, Ill.

Eugene Feuchtinger, **PREFECT VOICE INSTITUTE**
210 S. Clinton St., Studio A-1, Chicago 6, Ill.

Please send me—free and without obligation—your helpful book "How to Strengthen Your Voice for Greater Success." Mail in plain wrapper. No salesman will call. I am mostly interested in the following: (Please check one or more)

Business advancement; Public Speaking; Singing

Name

Address

City & State

My age is:

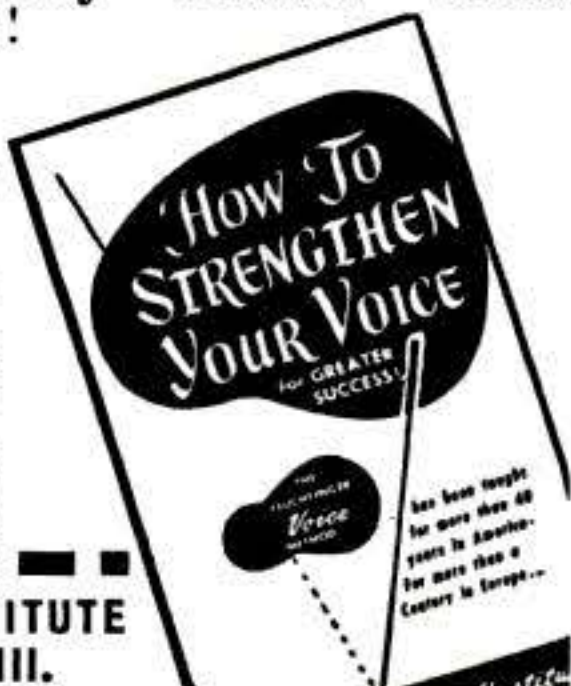

EAR NOISES?

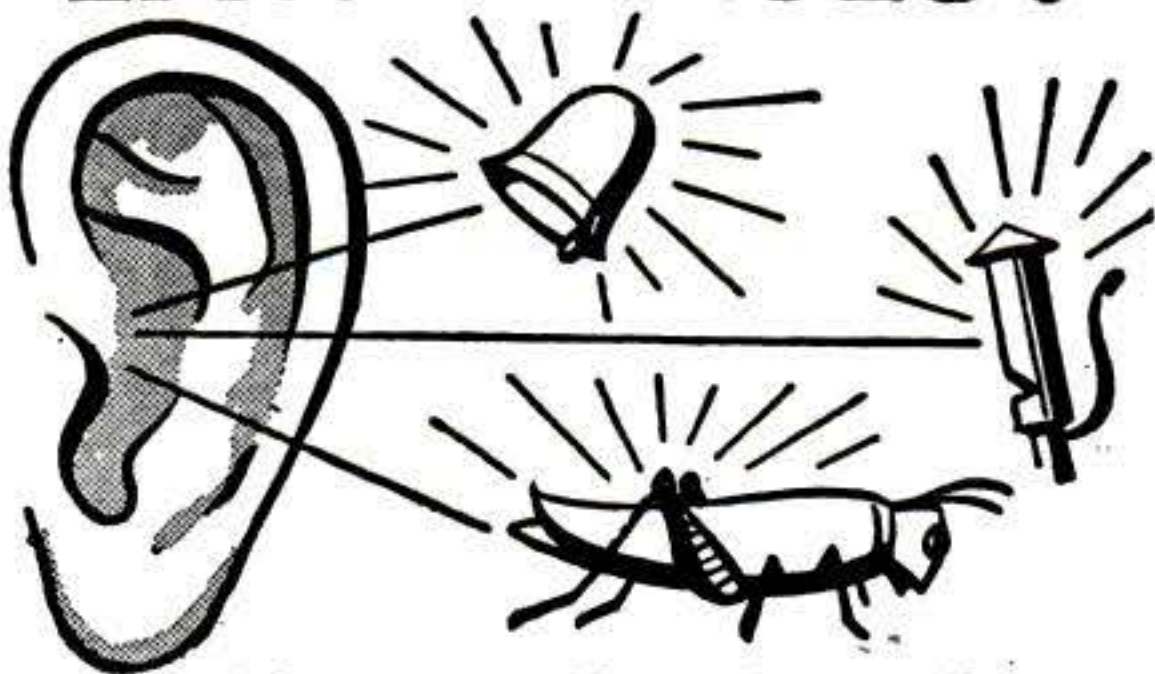

If you suffer from those miserable ear noises and are Hard of Hearing due to catarrh of the head, write us NOW for proof of the good results many people have reported after using our simple home treatment. **NOTHING TO WEAR.** Many past 70 report ear noises relieved and hearing improved. **SEND NOW FOR PROOF AND 30 DAYS TRIAL OFFER.**

THE ELMO CO.
DEPT. 2 PS-1 DAVENPORT, IOWA

\$5000.00 in PRIZES

DRAW MY HEAD

OPEN TO AMATEUR ARTISTS ONLY!

1st & 2nd Prizes Complete \$130.00 Art Courses

80 OTHER VALUABLE PRIZES



Take this test and try for a thrilling prize. Discover if you have profitable Art talent. You may gain a lifetime of happiness and high earnings if you mail your drawing today. Amateurs only. Our present students not eligible. Copy this girl 4" to 6" high in pen or pencil and mail to us. None returned. Winners notified. New \$5,000 contest each month. Send your drawing now and include your name, address, age and occupation. Enter today.

WALLER ART EXCHANGE Studio 58, 1000 N. Charles St. Baltimore 1, Md.

TASOPE PHOTO-ENGRAVING PLANTS



MATERIAL COST OF THIS CUT 3/4c SELLING PRICE \$1.00 AND UP

Establish your own profitable **PHOTO-ENGRAVING** business. Make cuts for newspapers printers, and advertisers. Make etched name plates, plaques etc. Instructions furnished, no experience necessary. Sold direct from factory since 1931. First five hundred cuts sold locally or by mail will pay for plant and pay you well for your time. Write for **FREE** catalog. **TASOPE DEPT. PS1, AURORA, MO.**

DYNAMIC POWER TOOL COMBINATION



INCLUDES: Cummins 1/4" Electric Drill; Cummins Saw Attachment; Combination Saw Blade; Set of Drills; Lambs Wool Bonnet; 6 Sanding Disks; Steel Arbor and Attachments; Cloth Buffing Wheels; Grinding Wheel; Wire Wheel Brush; Steel Paint Mixer; Steel Bench Stand; Portable Steel Carrying Case.

Price of Dynamic Power Tool Combination complete is \$26.95

SHIPPED ON APPROVAL NO MONEY WITH ORDER—NO C. O. D.

Try it ten days before you buy. If completely satisfied then send \$2.95 and pay balance at rate of \$4.00 per month for 6 months—**No Interest or Carrying Charges Added.** If not completely satisfied, return to us, no explanation necessary.

KAPNER HARDWARE, INC.
Dept. A-22, 2248 Second Ave., N. Y. 29, N. Y.

AUDELS Carpenters and Builders Guides 4 vols. \$6



Inside Trade Information for Carpenters, Builders, Joiners, Building Mechanics and all Woodworkers. These Guides give you the short-cut instructions that you want—including new methods, ideas, solutions, plans, systems and money saving suggestions. An easy progressive course for the apprentice and student. A practical daily helper and Quick Reference for the master worker. Carpenters everywhere are using these Guides as a Helping Hand to Easier Work, Better Work and Better Pay. To get this assistance for yourself, simply fill in and mail the FREE COUPON below.

Inside Trade Information On:

How to use the steel square—How to file and set saws—How to build furniture—How to use a mitre box—How to use the chalk line—How to use rules and scales—How to make joints—Carpenters arithmetic—Solving mensuration problems—Estimating strength of timbers—How to set girders and sills—How to frame houses and roofs—How to estimate costs—How to build houses, barns, garages, bungalows, etc.—How to read and draw plans—Drawing up specifications—How to excavate—How to use settings 12, 13 and 17 on the steel square—How to build hoists and scaffolds—skylights—How to build stairs—How to put on interior trim—How to hang doors—How to lath—lay floors—How to paint



AUDEL, Publishers, 49 W. 23rd St., New York 10, N. Y.
Mail Audels Carpenters and Builders Guides, 4 vols., on 7 days free trial. If OK I will remit \$1 in 7 days and \$1 monthly until \$6 is paid. Otherwise I will return them. No obligation unless I am satisfied.

Name _____
Address _____
Occupation _____
Employed by _____ 23

Audels PRACTICAL ELECTRIC LIBRARY



Answers YOUR QUESTIONS!
WHAT EVERY ELECTRICIAN WANTS TO KNOW

Is easily found in AUDELS ELECTRIC LIBRARY. Electricity made simple as ABC. Practical inside trade information for the expert and ALL electrical workers.

Questions, answers, diagrams, calculations, underwriter's code; design, construction, operation and maintenance of modern electrical machines and appliances FULLY COVERED.

All available at small cost, easy terms. BOOK-A-MONTH service puts this Important information in your hands for 6¢ a day. You can start your subscription with any volume.

Write TODAY for Electric Folder and FREE TRIAL offer.

AUDEL, Publishers, 49 W. 23rd St., New York 10, N. Y.

Mail Vol. I, Electric Library on 7 days' free trial. If O.K. I will remit \$1.50, otherwise I will return it. I also request you to mail one book each month on same terms. No obligation unless I am satisfied.

Name.....
Address.....
Occupation.....
Employed by..... 23

WHAT EVERY AUTO MECHANIC WANTS TO KNOW

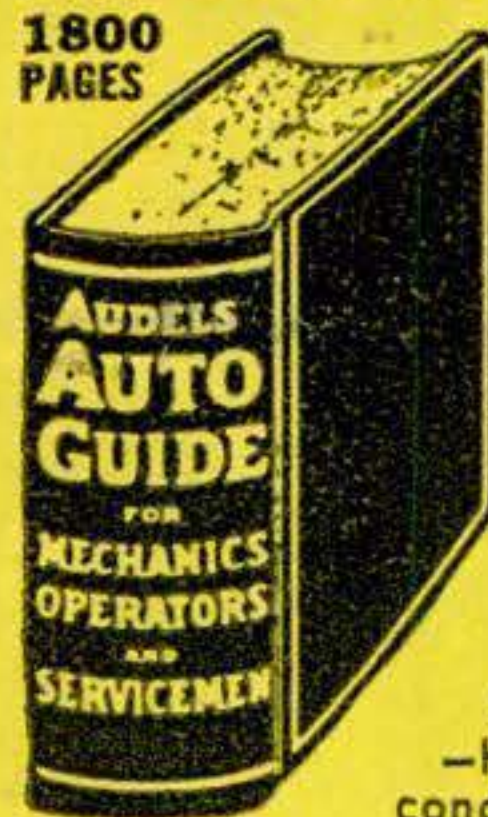

This Big Practical Book gives full information with working diagrams covering the principles, construction, ignition, service and repair of modern cars, trucks and buses.

Diesel Engines, Hydramatic and Fluid Drives Fully Explained.

A complete Guide of 1800 pages, with over 1500 illustrations showing inside views of the working parts, with instructions for service jobs.

IT PAYS TO KNOW

How to fit pistons—How to locate engine knocks—How to fit connecting rod bearings—How to service main bearings—How to re-condition valves—How to time valves—How to adjust fan belts—How to adjust carburetors and

chokes—How to rebuild a clutch—How to service automatic transmissions—How to service brakes—How to adjust steering gear—How to cope with ignition troubles—How to service distributors—How to time ignition—How to "tune up" an engine.

\$4 COMPLETE • PAY \$1 A MO.
TO GET THIS ASSISTANCE FOR YOURSELF SIMPLY FILL IN AND MAIL COUPON TODAY.



Step up your own skill with the facts and figures of your trade. Audels Mechanics Guides contain Practical Inside Trade Information in a handy form, Fully illustrated and Easy to Understand. Highly Endorsed. Check the book you want for 7 DAYS FREE EXAMINATION. Send No Money, Nothing to pay Postman.

CUT HERE MAIL ORDER



AUDEL, Publishers, 49 W. 23 St., NEW YORK 10, N. Y.

Please send me postpaid for FREE EXAMINATION books marked (X) below. If I decide to keep them I agree to mail \$1 in 7 Days on each book or set ordered and further mail \$1 monthly on each book or set until I have paid price, otherwise I will return them.

- TRUCK & TRACTOR GUIDE, 1299 Pages . . . \$ 4
- AUTOMOBILE MECHANICS GUIDE, 1800 Pages . . . 4
- DIESEL ENGINE MANUAL, 575 Pages . . . 2
- MACHINISTS HANDY BOOK, 1650 Pages . . . 4
- WELDERS GUIDE, 400 Pages . . . 1
- BLUE PRINT READING, 416 Pages . . . 2
- MATHEMATICS & CALCULATIONS, 700 Pages. . . 2
- SHEET METAL PATTERN LAYOUTS, 1100 Pages . . . 4
- SHEET METAL WORKERS HANDY BOOK, 388 Pgs. . . 1
- MECHANICAL DRAWING GUIDE, 160 Pages . . . 1
- MECHANICAL DRAWING & DESIGN, 480 Pages . . . 2
- AIRCRAFT WORKER, 240 Pages . . . 1
- TELEVISION SERVICE MANUAL, 384 Pages. . . 2
- RADIOMANS GUIDE, 914 Pages . . . 4
- ELECTRONIC DEVICES, 216 Pages . . . 2
- ELECTRIC MOTOR GUIDE, 1000 Pages . . . 4
- ELECTRIC WIRING DIAGRAMS, 272 Pages . . . 1
- ELECTRICIANS EXAMINATIONS, 250 Pages. . . 1
- ELECTRIC POWER CALCULATIONS, 425 Pages. . . 2
- HANDY BOOK OF ELECTRICITY, 1440 Pages. . . 4
- ELECTRIC DICTIONARY, 9000 Terms . . . 2
- ELECTRIC LIBRARY, 7000 Pages (12 Book Set) 18
- MARINE ENGINEERS HANDY BOOK, 1258 Pgs. . . 4
- SHIPFITTERS HANDY BOOK, 250 Pages . . . 1
- REFRIGERATION & Air Conditioning, 1280 Pgs. . . 4
- MILLWRIGHTS & MECHANICS GUIDE, 1200 Pgs. . . 4
- POWER PLANT ENGINEERS GUIDE, 1500 Pages . . . 4
- ENGINEERS & FIREMANS EXAMS, 525 Pages . . . 1
- PUMPS, Hydraulics & Air Compressors, 1658 Pgs. . . 4
- ENGINEERS LIBRARY (3 Book Set) . . . 9
- MECHANICAL DICTIONARY, 950 Pages . . . 4
- GARDENERS & GROWERS GUIDES (4 Book Set) . . . 6
- CARPENTERS & BUILDERS GUIDES (4 Book Set) . . . 6
- PLUMBERS & Steamfitters Guides (4 Book Set) . . . 6
- MASONS AND BUILDERS GUIDES (4 Book Set) . . . 6
- PAINTERS & DECORATORS MANUAL, 450 Pgs. . . 2
- HOUSE HEATING GUIDE, 1000 Pages . . . 4
- OIL BURNER GUIDE, 384 Pages . . . 1

Check NOW!

You Can Look Over Any Guide In Your Own Home

Start the Easy Payments If Satisfied

MAIL THIS TODAY



Name.....
Address.....
Occupation.....
Employed by..... 23

NOW—BE A FULLY RADIO-TELEVISION 10 MO



**I Send You
18 BIG
KITS**

**OF RADIO-
TELEVISION
EQUIPMENT**

EXTRA MONEY

**Earn While You Learn
In Your Spare Hours!**

You do all your training with me AT HOME in spare hours. Keep right on with your present job and income while learning—and earn extra cash besides! The day you enroll I begin sending you plans and ideas for doing profitable spare time Radio-TV work. Many of my Sprayberry students pay for their entire Radio-TV training this way!



YOU KEEP THIS VALUABLE EQUIPMENT

The many big kits of Radio-Television parts and equipment are sent to my students "for keeps." Nothing need be returned—it is YOURS! There is absolutely nothing else to buy!

TRAINED, QUALIFIED TECHNICIAN IN JUST N T H S OR LESS !

New "Package" Unit Training Plan—PAY AS YOU LEARN—YOU SET THE PACE! TRAIN AT HOME IN SPARE HOURS!—No Monthly Payment Contract to Sign!

Now . . . be ready for Radio-Television's big pay opportunities in a few short MONTHS! Frank L. Sprayberry's completely new "Package" training unit plan prepares you in just 10 MONTHS . . . or even less! Equally important, there is NO monthly payment contract to sign . . . thus NO RISK to you! This is America's finest, more complete, practical training—gets you ready to handle any practical job in the booming Radio-Television industry. In just 10 months you may start your own profitable Radio-Television shop . . . or accept a good paying job in this fascinating expanding field in work you've always wanted to do. Mr. Sprayberry has trained hundreds of successful Radio-Television technicians—and stands ready to train you in less than one year, even if you have no previous experience. You learn by DOING . . . actually working with your hands with equipment of special design to illustrate basic theory instead of relying on books alone. Your training is very interesting because it's really practical.

The Sprayberry 10 MONTH TRAINING PLAN includes, Radio, Television, FM (Frequency Modulation), Public Address Systems . . . everything you need to make big money in this fast moving industry. This new Sprayberry "package" plan includes many kits of genuine, professional Radio-Television equipment. While training at home in spare hours you actually perform over 300 demonstrations, experiments and construction projects. In addition, you build a powerful 6-tube standard and short wave radio set, a multi-range test meter, a signal generator, signal tracer and many other projects. All equipment is yours to keep . . . you have practically everything you need to set up your own service shop. The interesting book-bound lessons, manuals, bulletins . . . all are yours to keep. If you expect to be in the armed forces later, there is no better preparation than good Radio-Television training. These are sound, logical, money-in-the-bank reasons why this training is the best training of all for you.

MEET A FEW OF MY GRADUATES



Training Leads to Good Radio Job
"Got a job in local radio shop soon after enrolling. Very satisfied with training."
— Stanley Clemmons, Kansas.



Radio Profits Pay Cost of Training
"I have more than taken in the cost of your training doing spare time radio repair work. See bright future ahead."
— Thomas Shearer, N. Y.



Earns Easy Spare Time Cash
"While training I made about \$180.00 in spare time. Thank you for wonderful Radio-TV training."
— Herbert Burroughs, W. Virginia.

Be Ready for Top Paying Radio-Television Jobs!

Radio-Television is growing with amazing speed. More than 2000 broadcasting stations PLUS an additional 102 Television stations are now on the air. Radio sets and TV receivers are being made and sold in record breaking numbers. If you enjoy working with your hands . . . if you like interesting and varied work . . . YOU BELONG IN RADIO-TELEVISION. But you MUST have good Training to "cash in" . . . the training that starts with basic fundamentals and carries through every circuit and problem of Radio-TV.

No Previous Experience Needed to Succeed

My Training in Radio-Television is so complete, so down-to-earth that previous experience is not necessary. I start you with basic fundamentals and carry you in easy, practical steps through one Radio-Television subject after another. You will be amazed at your rapid progress and your knowledge of Radio-Television. Best of all, you put this knowledge to work making spare time cash soon after you enroll! You may train as fast or as slowly as suits your convenience. Each of my students receives individual training!

IF YOU ARE EXPERIENCED IN RADIO

Men already in Radio who seek a short intensive 100% TELEVISION Training with FULL EQUIPMENT INCLUDED are invited to check and mail the coupon at the right.

FREE 3 Big Radio and Television Books



I want you to have ALL the facts about my complete system of Radio-Television Training! Act now! Rush the coupon for my three big Radio-Television books: "How To Make Money in Radio-Television," PLUS my new illustrated Television bulletin PLUS an actual sample Sprayberry Lesson—all FREE with my compliments. No obligation and no salesman will call on you. Send the coupon in an envelope or paste on back of post card. I will rush all three books at once!

Mail Coupon Today!

NO OBLIGATION
No Salesman
Will Call

SPRAYBERRY ACADEMY OF RADIO, Dept. 55-E
111 North Canal St., Chicago 6, Ill.

Please rush to me all information on your Radio-Television Training plan. I understand this does not obligate me and that no salesman will call upon me.

Name..... Age.....

Address.....

City..... State.....

Please Check Below About Your Experience

Are You Experienced? No Experience

Sprayberry Academy of Radio, Dept. 55-E
111 North Canal St., Chicago 6, Ill.

Copyrighted material

NORTHROP Training Gives YOU the "Edge"



IN AERONAUTICAL ENGINEERING— AIRCRAFT & ENGINE MECHANICS

Northrop training can help you qualify for a profitable, permanent, and interesting future—help bring success and promotion faster—give you the "edge" in an aviation career. As a Northrop graduate, you will be backed by the prestige of a name famous throughout aviation! Northrop training can be your passport to opportunity and success.



NORTHROP Training is Outstanding Skilled Northrop instructors give you up-to-the-minute training in the rapidly advancing science of aviation. You learn thoroughly in a minimum time! You use the newest training aids—live jet engines, wind tunnel, single and multi-engine aircraft, laboratory and shop equipment of all kinds.

Military Advantages In civilian or military life, Northrop training counts. For example, NAI engineering graduates are educationally qualified to become Air Force Cadets, Naval Aviation Cadets, or Officer Candidates.

APPROVED FOR VETERANS

Northrop Aeronautical Institute

1525 E. Broadway, Hawthorne, Los Angeles County, Calif.



NORTHROP AERONAUTICAL INSTITUTE

1525 E. Broadway, Hawthorne, Los Angeles County, Calif.

Please send me immediately the Northrop catalog, special military information and employment data, and schedule of starting dates of classes. I am interested in:

Aeronautical Engineering ★ Aircraft & Engine Mechanics

Name _____ Age _____

Address _____

City _____ Zone _____ State _____

VETERANS—Check here if you are entitled to training benefits under the G. I. Bill.

LEARN AT HOME TO MOUNT BIRDS



Animals, Heads, Fishes, Pets; to TAN. Be a Taxidermist. Profit and FUN.

Hunters, save your valuable TROPHIES. Mount ducks, squirrels, everything. Learn to TAN for leather and furs. Wonderful HOBBY Have a HOME MUSEUM. BIG PROFITS mounting for others. INVESTIGATE NOW.

FREE BOOK With 100 fine game pictures. NOW absolutely FREE. Write TODAY.

Send Postal TODAY for FREE BOOK. State AGE. N. W. SCHOOL OF TAXIDERMISTRY, Dept. 2601, Omaha, Neb.



INVENTORS

Before you make any effort to market your invention, you should take the first steps toward proceeding for patent protection.

I shall be pleased to furnish you with information relative to patent procedure upon request from you, and this will be without any obligation on your part.

PATRICK D. BEAVERS
Registered Patent Attorney

937 Columbian Building, Washington 1, D. C.

INVENTORS

IF YOU WISH TO PROTECT YOUR INVENTION, You should take steps to protect it by a U. S. Patent. Write me for "INVENTION RECORD" FORM

CARL MILLER
REGISTERED PATENT ATTORNEY

WOOLWORTH BLDG., 35th FLOOR, 12C
NEW YORK CITY

INVENTORS

Send today for "Patent Protection for Inventors" outlining preliminary steps to take toward patent protection, also convenient "Evidence of Invention" Form.

VICTOR J. EVANS & CO.
740-A Merlin Building • Washington 6, D. C.

INVENTORS

Send for
PATENT INFORMATION

Book and
INVENTOR'S RECORD
without obligation

GUSTAVE MILLER
12-PS Warner Building
Washington 4, D. C.

**REGISTERED PATENT
ATTORNEY**

PATENT ATTORNEY & ADVISOR
U. S. NAVY DEPT. 1930-'47
ASSOCIATE EXAMINER
U. S. PAT. OFF. 1922-1929
PATENT LAWYER

PATENTS

C. A. SNOW & CO.

REGISTERED PATENT ATTORNEYS

WRITE FOR INFORMATION TO

426 SNOW BUILDING, WASHINGTON 1, D. C.

INVENTORS

Whether an invention is patentable can be substantially determined by a search of the U. S. Patent records. Without obligation, write for information explaining the steps you should take to secure a patent.

JOHN N. RANDOLPH

Registered Patent Attorney
205 Columbian Building Washington 1, D. C.

INVENTORS

Avoid financial losses. Put your patent searches and the preparation of your patent applications in the hands of a firm that guarantees its work. Send for details on our insured plan and free "Record of Invention" form. Mail coupon today. No obligation.

GUARANTY PATENT SERVICE,
622-B Kass Building, Washington 5, D. C.

Without obligation, please rush "Record of Invention" form and details on your guaranteed patent service.
PRINT NAME AND ADDRESS BELOW

.....
.....

TRAIN AT HOME IN YOUR SPARE TIME

DON'T PUT IT OFF...MAIL TODAY!

GET THE MONEY AND SECURITY YOU'VE ALWAYS WANTED!



L. J. ROSENKRANZ, President, National Schools, the man who has trained many, many men like YOU. Men who now own successful, respected businesses of their own. Men who hold important, high-paying positions in famous companies. You CAN be a success. Mail coupon for more details.

Let Me Show You How! Mail the Coupon for My FREE Books!

Each book has page after page in color. Gives you the complete story about my proved training method...tells how quickly it can train you for a secure, high-paying job. Don't wait. Get the facts. Send today for my valuable books on Radio-Television or Automotive-Diesel. Check the coupon at right and mail it to me today. Absolutely no obligation.

NO SALESMAN WILL CALL!

I'll send you a **FREE SAMPLE LESSON TOO**, if you act fast! Shows how easy it is to learn with National Schools Home Training.

NATIONAL SCHOOLS, Dept. C-12
4000 South Figueroa Street
Los Angeles 37, California

Mail in envelope
or paste on
penny postal card

Send me *Free* the book checked below and the sample lesson. I understand no salesman will call on me.

- "MY FUTURE IN RADIO-TELEVISION & ELECTRONICS" OR
- "MY FUTURE IN DIESEL-AUTOMOTIVE & ALLIED MECHANICS."

NAME _____ AGE _____

ADDRESS _____

CITY _____ ZONE _____ STATE _____

Check here if you were released from the service less than 4 years ago.



Let National Schools - a resident-training school for nearly 50 years-train you at home for today's unlimited opportunities in Radio-TV or Automotive-Diesel. National Schools is one of the largest schools of its kind in the world. It has 4 big buildings of modern shops and labs. Its faculty is considered tops. You learn fast from easy lessons -all perfected under actual shop conditions. Approved for eligible vets.



Earn Extra Money while you're learning! I'll show you how!
EASY TERMS • FREE GRADUATE SERVICE
Mail coupon today—find out more!

WHICH HIGH-PAYING FIELD DO YOU WANT?

TODAY'S SHORTAGE OF TRAINED TECHNICIANS CREATES CHANCE OF A LIFETIME FOR YOU...IN EITHER FIELD!

RADIO-TELEVISION & ELECTRONICS

OR

AUTOMOTIVE-DIESEL AND ALLIED MECHANICS

JOB SECURITY! BIG MONEY! FOR YOU IN TODAY'S EXPANDING INDUSTRIES!

Think of it! With guided missiles, radar and other electronic devices so important to national defense. With big, new developments in color TV. With over 90,000,000 home and auto radios, over 12,000,000 TV sets. With more than 3100 radio stations...over 100 TV stations—and more building every day—imagine the terrific opportunity you have!

You Train at Home—In Your Spare Time

With National Schools Master Shop Home Training, you master *all* phases of Radio-Television-Electronics. You learn fast from hundreds of pictures and diagrams. All lessons have been developed and tested in National Schools famous shops and labs. No wonder your National Schools training is so up-to-date, practical, interesting. And so easy!

LOOK! WE SEND YOU ALL THESE PARTS! —and you keep them!



We send you lots of standard professional parts. You do lots of practical experiments. You learn step by step. Until you can build the big Superheterodyne Receiver you see above—and other important test units. Mail the coupon—today.

I TRAIN YOU FOR GOOD-PAYING JOBS LIKE THESE

Radio Station Engineer; District Service Manager; Aircraft Radio Inspector; Inspector Technician; Own your own repair shop; Service Specialist; Special Civil Service Positions; Sound Truck Operator; Complete Television Service and many others. Thousands of National Schools graduates have jobs like these. Why not you? Start your career—be sure to mail the coupon today.

Only National Schools Gives You This Professional Multi-Tester



You get this factory-made new Multi-Tester...an important instrument every Radio-TV man must have.

GREATEST DEMAND FOR TRAINED MEN IN HISTORY! NOW IS YOUR CHANCE!

What an opportunity! With over 8 million older cars needing big service and repair jobs. With defense industry having more high-paying jobs than they can fill. With the Armed Forces offering quick advancement to trained mechanics. **YOU ARE NEEDED** as never before! Now you can get the good pay, security, the satisfaction of doing what you *want* to do! Don't delay—mail the coupon **NOW!**

Right in Your Own Home!

You learn all about Gasoline Engines, Diesel and Special-Fuel Engines, Automotive Tune Up, General Garage Mechanics, Auto Electrical Service. You get complete training for this great, growing industry.

Yet National Schools Home Training is easy! Because it's based on actual shop methods in National Schools big resident school. Mail the coupon for more details—NOW.

National Schools Gives You All These Tools

You start out owning the tools of your trade. A kit of standard, professional tools and equipment. They're all part of your course! —And you keep them—they're yours!

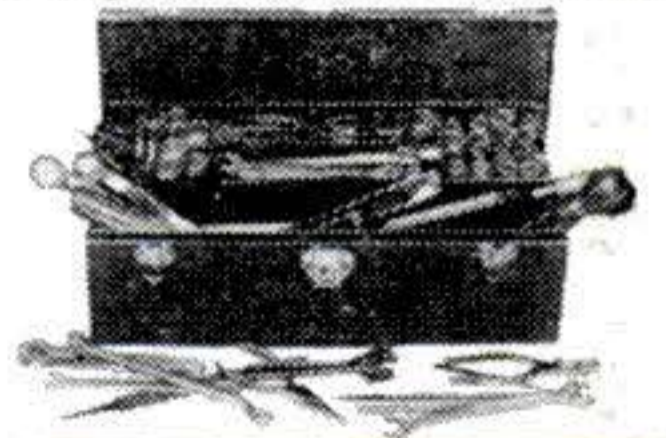

I Offer You All These!

Basic Lesson Texts. Diesel Installation & Maintenance Instructions. Spare Time Lessons. Engine Service Manuals. Engine Repair Drive Systems. Diesel Electric Power Texts. Special Thermodynamic Instruction.

Attention: Men Going into the Service Soon!

With National Schools training in Radio-Television or Automotive-Diesel, you have the opportunity to get into special service classifications. That means higher pay and grade, more prestige—right away! This is important—so be sure to mail the coupon today without fail.

WHICH OF THESE HIGH-PAYING JOBS WOULD YOU LIKE?

- MOTOR TUNE UP SPECIALIST
- DIESEL ENGINE SPECIALIST
- FARM EQUIPMENT MECHANIC
- YOUR OWN GARAGE OR REPAIR SHOP
- GENERAL GARAGE MECHANIC
- PARTS DEALER
- AUTO ENGINE REBUILDING
- FUEL INJECTION SPECIALIST

You can *have* secure jobs like these. Just mail the coupon—and find out!

NATIONAL SCHOOLS TECHNICAL TRADE TRAINING SINCE 1905
LOS ANGELES 37, CALIFORNIA

GET THE WORLD'S LEADING

RADIO & TV CATALOG

★ FREE

★ 1952

212-Page Edition

★ ALLIED'S

BIG COMPLETE BUYING GUIDE

Save on Everything
in Radio and TV



NEW
UP-TO-DATE
SEND FOR IT NOW

**Everything for Experimenters,
Builders, Amateurs, Service-
men, Engineers and Soundmen**

Send for ALLIED'S 212-page 1952 Catalog, the value-packed guide to *everything* in Radio and Television! Latest home radios, TV equipment, Amateur supplies, P.A. Systems, Hi-Fidelity Sound, recorders, test instruments, builders' kits—plus the world's largest stocks of electronic parts, tubes, tools, books and diagrams. Get more for your money—send today for your **FREE 1952 ALLIED Catalog!**



**Get Radio's Leading
Buying Guide Today**

FREE!

ALLIED RADIO

ALLIED RADIO CORP., Dept. 7-A-2
833 W. Jackson Blvd., Chicago 7, Ill.

Rush FREE 1952 ALLIED 212-Page Catalog.

Name _____

Address _____

City _____ Zone _____ State _____

No Experience Needed To PRINT YOUR OWN POST CARDS

The GEM STENCIL DUPLICATOR saves money... gets results quickly! Hundreds of uses for every type of business and organization. We ship the GEM complete with all supplies, Guide Board for accurate printing and 60-page Book of Ideas at the special low price of only **\$8.50** (a \$15 value).



FREE TRIAL OFFER

Our
21st Year

Use the GEM **FREE** at our expense! **SEND NO MONEY.** Write and complete GEM outfit will be sent you postpaid. After ten days, send us only **\$8.50** or return the GEM. You must be satisfied!

BOND EQUIPMENT CO.

Dept. 49

6633 Enright • St. Louis 5, Mo.

"How to Make Money with Simple Cartoons"



A book everyone who likes to draw should have. It is free; no obligation. Simply address

FREE BOOK

CARTOONISTS' EXCHANGE

Dept. 191D

Pleasant Hill, Ohio

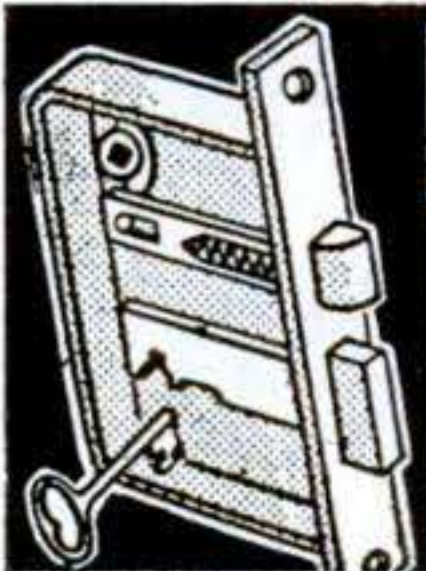

FIX LOCKS

Learn Locksmithing and Keymaking from Experts in Your Spare Time at Home! Locksmiths in big demand! No layoffs, no slow seasons! Age or physical handicap no disadvantage. Year-round income in this permanent, respected field. Full or part time. Practical, illustrated lessons show how to make money even while learning! All materials, special tools supplied. **FREE BOOK-LET. LOCKSMITHING INST. 15 Park Ave. Dept. PS-25, Rutherford, N. J. Lic. & Approved by State of N. J. V.A. Approved.**

FOR FUN OR PROFIT
LEATHERCRAFT,
TEXTILE PAINTING,
COPPER TOOLING,
KITS, PROJECTS,
TOOLS, SUPPLIES

REMEMBER

RUSSO for ALL LEATHER & CRAFT SUPPLIES!

SEND 25c FOR OUR **BIGGEST CATALOG YET** 25c REFUNDED WITH 1st ORDER

RUSSO HANDICRAFT SUPPLIES Dept. 4, 245 S. Spring, Los Angeles 12, Calif

High School at Home

Many Finish in 2 Years

No classes. No time wasted going to and from school. Progress as fast as your time and abilities permit. Standard H. S. texts supplied. Thousands enroll each year in this 55-year-old school. Send for **FREE** descriptive booklet.

AMERICAN SCHOOL, Dept. H-146
Drexel at 58th St., Chicago 37, Ill.

Without obligation, please send **FREE** descriptive booklet.

Name.....

Address.....

NOW-SEE AT A GLANCE HOW TO FIX ANY CAR

No Matter Whether You're an Experienced Mechanic or Just a "Green" Beginner!

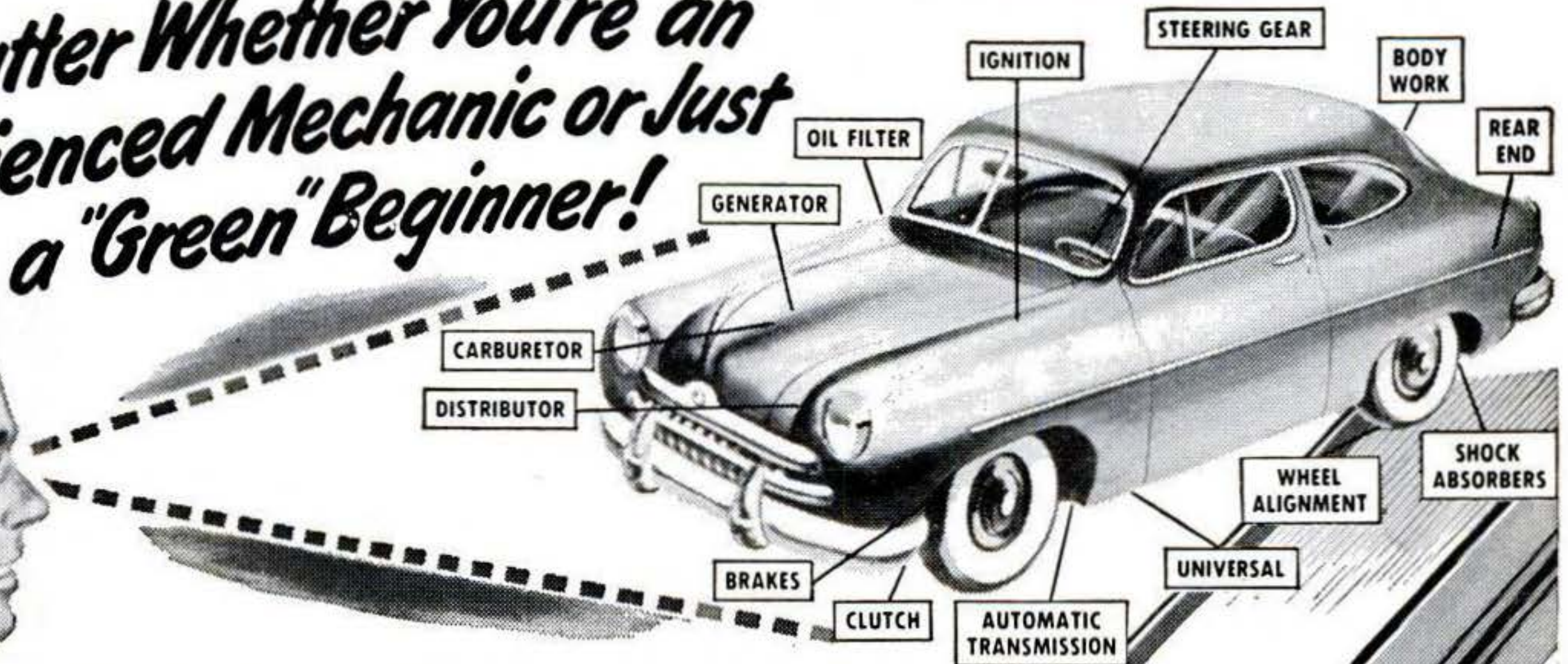

With MOTOR'S New AUTO REPAIR MANUAL
At Your Elbow, You'll "Whiz Through" ANY
Repair Job on ANY Car Built from 1935 to 1951

Here's What Users Say . . . About this "Auto Repair Man's Bible"

Other Mechanic Worked Half a Day—He Does Job in Half an Hour—"I fixed a motor in 30 minutes after another mechanic had worked on it half a day."—**C. AUBERRY**, Murfreesboro, Tenn.

No Trouble Learning—"Instructions so clear have no trouble learning anything about any car. Now working as mechanic in big plant."—**SAM ORDONEZ**, Calif.

Paid For Itself On First 2 Jobs—"MOTOR'S Manual paid for itself on the first 2 jobs, and saved me valuable time by eliminating guesswork."—**W. SCHROP**, Ohio

IMAGINE being able to see "at a glance" how to repair any car! No wonder thousands "rave" about MOTOR'S great new AUTO REPAIR MANUAL!

It TELLS and SHOWS everything you need to know to service, repair, tune-up or overhaul ANY part of 800 different car models. Just look up make, model, and job. Right before your eyes are giant pages of easy step-by-step directions . . . charts and diagrams . . . large clear photographs. What tools to use. Where to start. How to perform each simplified step.

Over TWO THOUSAND Pictures! So Complete, So Simple, You CAN'T Go Wrong!

NEW, REVISED edition! 771 giant pages; 2300 "This-Is-How" pictures. Over 200 "Quick-Check" charts—more than 38,000 repair specifications. 225,000 service and repair facts. Brings you the "meat" of 150 Official Shop Manuals. Instructions and pictures are so clear you can't go wrong!

Even a green beginner can do a good job with this giant manual. Top-notch mechanics will find amazing shortcuts. No wonder this guide is used by the U. S. Army, Navy, and hundreds of thousands of repair men!

Pays for Itself in No Time

How to make a simple carburetor adjustment—or completely rebuild the transmission. ILLUSTRATED step-by-step guidance on all types of Engines . . . Chokes . . . Fuel Pumps . . . Ignition Systems . . . Oil Filters . . . Generators . . . Carburetors (Including new GM Rochester) . . . Starting Motors . . . Clutches . . . Transmissions. (Including all automatic and semi-automatic types) . . . Overdrives . . . Universals . . . Axles . . . Brakes . . . Steering Gears . . . Shock Absorbers, Basic Body Repair, AND MUCH MORE.

SEND NO MONEY

Try this great book—at our risk—for a full week FREE! See for yourself how it can save you money. If this giant book doesn't pay for itself in 7 days, simply return it and pay nothing. Mail coupon NOW to MOTOR Book Dept., Desk 2A, 250 W. 55th Street, New York 19, N. Y.

COVERS 800 MODELS

Buick
Cadillac
Chevrolet
Chrysler
Crosley
DeSoto
Lincoln
Mercury
Nash

Dodge
Ford
Frazer
Hudson
Henry J
Kaiser
Lafayette
LaSalle

Oldsmobile
Packard
Plymouth
Pontiac
Studebaker
Terraplane
Willys
ALSO
tune-up
adjustments
for
others.

BRAND NEW EDITION!
USED BY
U.S.
ARMY
AND
NAVY



Return and Pay Nothing If Not Satisfied

MAIL COUPON NOW FOR 7-DAY FREE TRIAL

MOTOR Book Dept., Desk 2-A,
250 West 55th Street, New York 19, N. Y.

Rush to me at once: (Check box opposite book you want)

MOTOR'S New AUTO REPAIR MANUAL. If O.K. I will remit \$1 in 7 days, plus 35c delivery charge—then \$2 monthly for 2 months, and a final payment of 95c a month later. Otherwise I will return book post-paid in 7 days. (Foreign price, remit \$8 cash with order.)

MOTOR'S New TRUCK & TRACTOR REPAIR MANUAL. (Described at left.) If O.K. I will remit \$2 in 7 days, and \$2 monthly for 3 months, plus 35c delivery charge with final payment. Otherwise I will return book promptly. (Foreign price, remit \$10 cash with order.)

Print Name Age

Print Address

City & Zone No. State

SAVE 35c delivery charges by enclosing WITH COUPON check or money order for full payment of \$5.95 for Auto Manual (or \$8.00 for Truck Manual). Same 7-day return-refund privilege applies.

Same FREE 7-Day Offer On MOTOR'S TRUCK & TRACTOR REPAIR MANUAL

Covers EVERY job on EVERY popular make gasoline truck or farm tractor made from 1936 thru 1951! Over 1400 pictures, 925 pages, 300,000 facts. All types Gasoline Engines, Fuel Systems, Starters, Generators, Clutches, Transmissions, Brakes, Steering, etc. For FREE trial, check proper box in coupon.



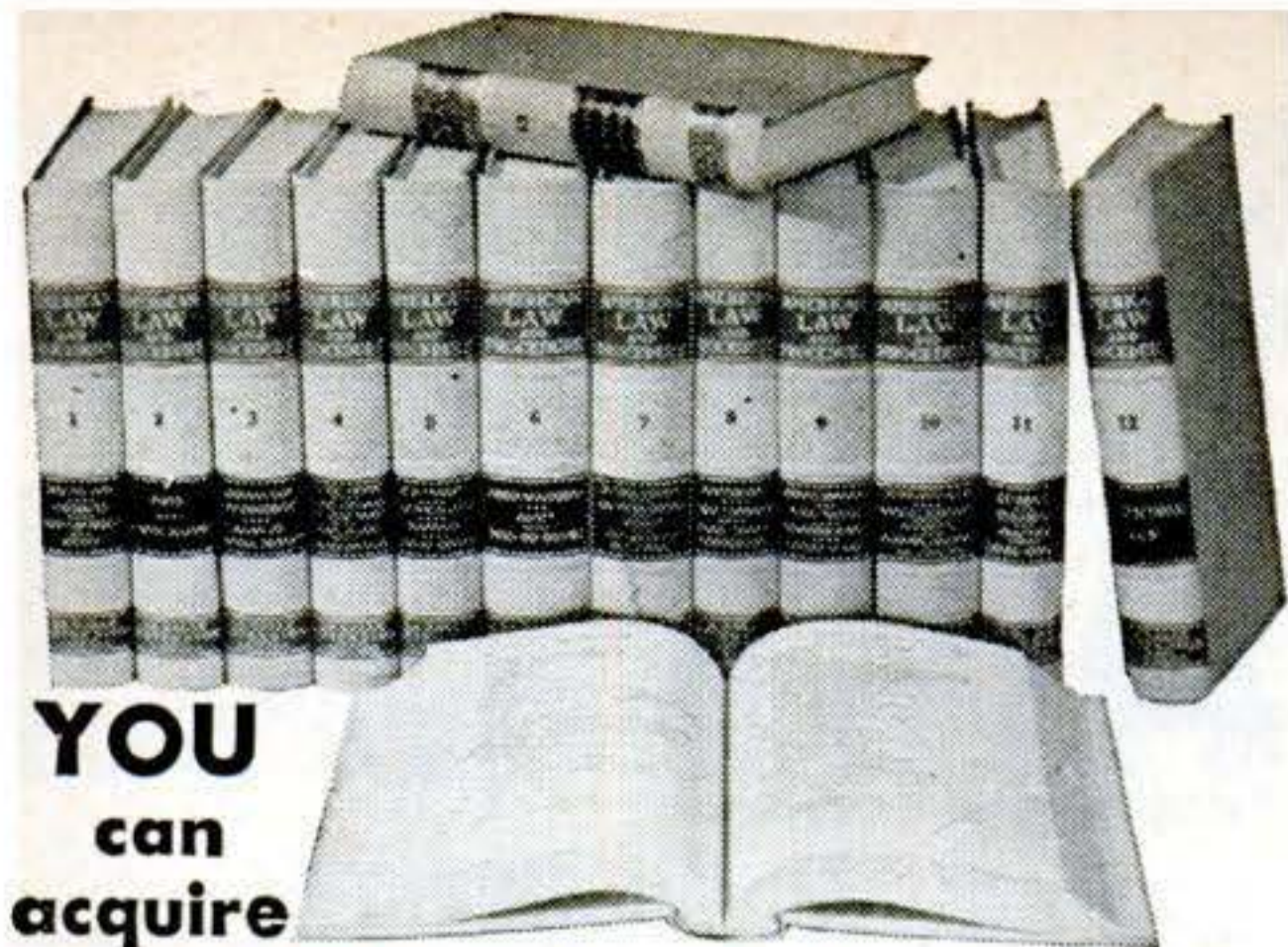

**YOU
can
acquire**

LAW NIGHTS AT HOME! L. L. B. DEGREE

LaSalle's famous Law Library—used as reference in many Law libraries and Law offices—has enabled thousands to master Law surprisingly fast, in spare hours at home, for business and professional advancement.

These 14 remarkable volumes, compiled by leading professors and lawyers, cover the whole basic field of Law in condensed, orderly, simplified manner.

You advance rapidly with this great library, plus special lectures furnished. We guide you step-by-step with personalized Problem Method of instruction . . . you *learn by doing*—handling legal problems—not by memorizing rules.

Send for two FREE 48-page booklets, "Law Training for Leadership," and "Evidence," answering questions about Law and its value to you, and telling how LaSalle Law graduates are winning rapid advancement in business and public life. Mail coupon below. No obligation.

LA SALLE EXTENSION UNIVERSITY A Correspondence Institution

417 S. Dearborn St. Dept. 183-L Chicago 5, ILL.

Send me your two FREE booklets described above, without obligation.

Name _____ Age _____

Street _____

City, Zone & State _____

SHORTHAND IN 6 WEEKS AT HOME

**Write 120 Words
Per Minute**

AGE NO OBSTACLE

Famous Speedwriting Shorthand System. No signs; no symbols; no machines. Uses ABC's. Easy to learn and use. Fast preparation for a position and a sound future.

Nationally used in leading offices and Civil Service; also by executives, speakers, writers, lawyers, students at college, scientists. Over 100,000 taught by mail. The very low cost will surprise you. Also class-room instruction and typing. 29th Year.

Write for Free Booklet to:

Speedwriting
Dept. 2601-2, 55 W. 42d St. N. Y. 18



"In my work as a writer I had long felt the need for a knowledge of shorthand, but had no time to learn it. One day I read a Speedwriting advertisement and decided to enroll. Within just a few short weeks I mastered Speedwriting and now its speed and accuracy are proving invaluable." — Joseph J. Kudlac, Clifton, N. J.

Watch Repairing Pays Big Money Learn at home

Free Literature Tells How

Watch repairers in big demand. You train step-by-step in 10 easy lessons. You learn to take a watch apart—repair and put in perfect working order. We furnish all tools, and a 15 jeweled watch. Practice movement with first lesson.



Turn spare time into cash—perhaps a business of your own. A licensed school. Students 18 to 65 have profited by our training. Low cost.

Write Today for All the Facts—No Obligation

ILLINOIS SCHOOL OF WATCH REPAIRING

2870 Elston Ave., Dept. PS-1, Chicago 18, Ill.

CLOSE OUT SALE UNUSED ELECTRIC MOTORS

1/3 H.P. \$11.95



Delco Model A8364 Type SP Cont., 115 V., 60 Cy., Single Ph., 1725 RPM. Weight only 21 lbs!

PRE-TESTED in every way—Priced so these unused 1/3 Horsepower motors will move quickly and give us needed room. Send cash, check or M.O. and we'll pay transit charges.

AERO PARTS SUPPLY, 8102-J Lockheed, Houston 17, Texas

MONEY for MEN ALL FREE

THE PLASTEX Industry needs manufacturers on small scale and for big production of Lamp and Clock Stands. Art Goods and Novelties in Plastex and Marble imitation. Experience unnecessary. 1/2c material makes regular 10c store sellers. Rubber moulds furnished for speed production. Small investment brings good returns. We are now placing big chain store orders with manufacturers. Ambitious men have chance for real prosperity. Our Free booklet will interest and benefit you.

PLASTEX INDUSTRIES, Dept. 2, 3400 Third Ave., New York 56, N. Y.

GET INTO REAL ESTATE Business



GET OUT OF DOORS. Increase your earnings and have more time out of doors. Taught by easy Home Study method by nationally known school. G.I. Approved. Can earn up to \$1,000 monthly. Sell while learning. **FREE BOOK** tells how to **PREPARE FOR A LIFETIME CAREER and MORE OUTDOOR TIME.** No obligation.

**WEAVER SCHOOL OF REAL ESTATE, Dept. NC-1
Suite 300 Law Bldg. Kansas City, Missouri**

I need 500 Men to wear SAMPLE SUITS!



Pay No Money—Send No Money

My plan is amazing! Just take a few easy orders for my sensational values in made-to-measure suits. Get your own suits **without a penny cost** and make money too! Men can't resist the outstanding style, long wear and low price of my made-to-measure suits. You need no experience. Spare time pays big profits. Rush name and address today for complete details. **Big Free Sample Outfit** contains more than 100 actual woolen samples, style illustrations, etc. Write now! **PROGRESS TAILORING CO., Dept. 8-220
500 S. Throop St., Chicago 7, Illinois**

I CAN TRAIN YOU **AT HOME**

FOR BIG PAY JOBS IN

TELEVISION RADIO

ELECTRONICS

WITHIN MONTHS!!

Leonard C. Lane

B.S., M.A., Exec. Dir. of Pierce School of Radio and Television. Licensed by the State of N. Y. - President of Radio-Television Training Association. Approved as a Correspondence School under the Laws of the State of N. Y.

AT NO EXTRA COST!
YOU GET A ROUND TRIP TO NEW YORK CITY

FROM ANYWHERE IN THE U.S. OR CANADA—PLUS 2 solid weeks; 50 hours of laboratory training on the most modern, complete, electronic equipment at the World-Famous **PIERCE SCHOOL OF RADIO AND TELEVISION**. After completing your Radio-Television Training Association Home-Study course, you receive two weeks' advanced instruction at the training shops and laboratories of Pierce School while you are in New York City—AT NO EXTRA COST! Only RTTA makes this amazing offer!

COMPARE THESE EXTRA BIG FEATURES!
RADAR

"The Electronic MIRACLE"—Only Radio-Television Training Association includes RADAR in your practical AT HOME training . . . PLUS

FCC STUDY AIDS

Get Higher Rating—More Pay in Army, Navy and Air Force!

WE FURNISH EVERYTHING

Including large picture TV Tube; can be converted for color TV. You BUILD and KEEP all units shown PLUS a C-W Telephone Receiver, AC-DC Power Supply unit (not illustrated). RTTA's effective method can help you toward a FAT PAY CHECK — OR YOUR OWN BUSINESS!

MODERN, ADVANCED NEW YORK LABORATORIES

Every modern, advanced electronic equipment for up-to-the-minute Radio-Television Electronic training, PLUS CBS and RCA Color Systems, PLUS operating Pierce Radio Station Club (W2GSV), PLUS Code Machine Set Up, PLUS complete TELEVISION STUDIO operating under supervision, by students! All the BEST to TRAIN you BEST!

I TRAINED THESE MEN and HUNDREDS MORE!



9/14/51 "My FCC License plus your practical Shop-Training Methods upped my earnings. Highly recommend your school."—Jim Stapleton



12/20/51 "Your training prepared me for this TV Technician job with security. I'll always be glad I chose your school."—Gil Grossinger



6/15/51 "I can look forward to a profitable future, as a TV Ser. Tech., thanks to your training."—I. Samuels



8/10/51 "It takes your type of training to get good jobs. As a TV Tech. I make good money."—Bill Atkinson

BOTH FREE

SET-UP YOUR OWN HOME LABORATORY WITH THE 15 BIG TELEVISION-RADIO KITS WE SEND YOU (At No Extra Cost)



YOU BUILD AND KEEP THIS GIANT SCREEN TELEVISION SET AND OTHER ILLUSTRATED UNITS

EARN EXTRA MONEY IN SPARE TIME!

Earn as much as \$5 an hour while learning! Many students pay for entire course with spare-time earnings! We show you how! **Free employment help!** Pierce graduates are holding good-pay jobs at NBC-TV, CBS-TV, RCA, DUMONT, EMERSON, FEDERAL TELEPHONE, PHILCO, ADMIRAL, HUGHES AIRCRAFT . . . Also at other leading Radio Stations, electronic firms as well as in the Armed Services!

BECOME A CERTIFIED TV TECHNICIAN

RTTA Shop-Methods Tops In Recognition! You owe it to yourself to get the BEST practical training AT HOME! Radio-Television Training Association can help you!

No Previous Experience or Training Needed!

Now, get in on the fastest growing, billion dollar field of Television-Radio-Electronics!

MAIL COUPON TODAY!

ONLY RTTA IS LOCATED AT TIMES SQUARE "IN THE HEART OF THE TELEVISION WORLD" WHICH OFFERS THIS UNIQUE, PRACTICAL HOME TRAINING PROGRAM!

Mr. Leonard C. Lane, President, Dept. 11 RADIO-TELEVISION TRAINING ASSOCIATION 1629 Broadway, New York 19, N. Y.

Dear Mr. Lane: Show me how I can make BIG MONEY IN TELEVISION within MONTHS! Rush by return mail my FREE Sample Lesson and BIG FREE Manual.

Name

Address

City Zone State.....

(PLEASE PRINT PLAINLY)

ACT NOW! FOR LIFETIME SECURITY

C. T. C. TRAINING IN DRAFTING

PREPARES FOR
PROMOTION
MORE MONEY
SUCCESS

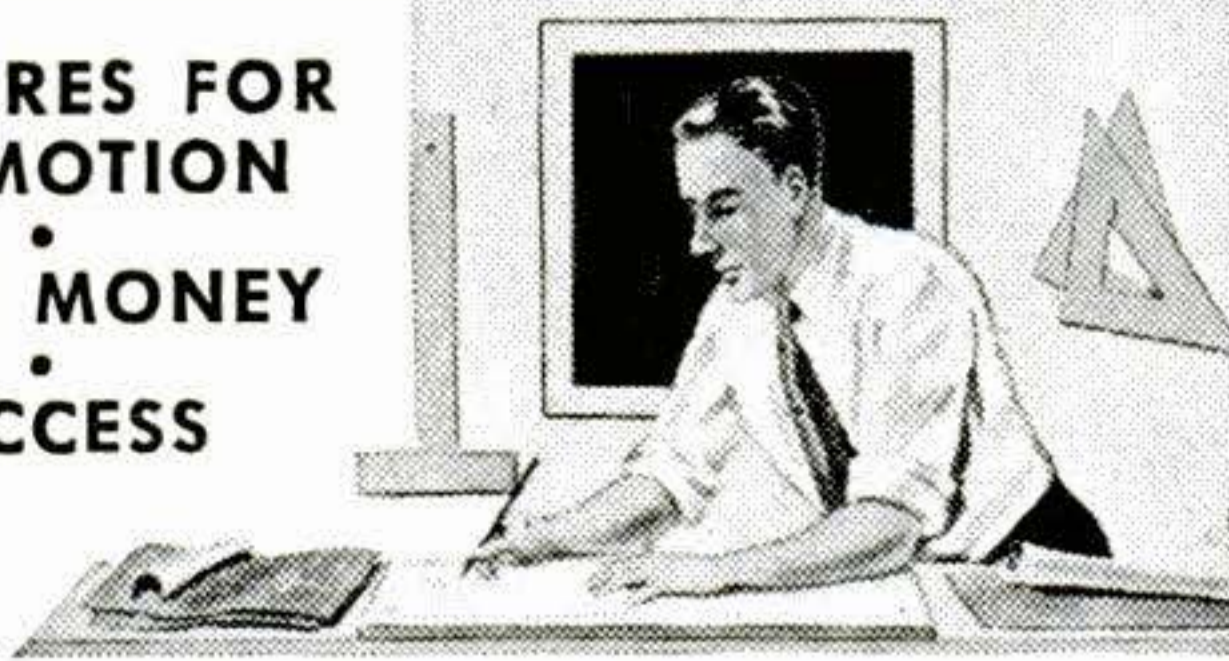

"Here I am at work making good money as a draftsman. I'm glad I sent the coupon to Chicago Tech for that Free Trial Lesson and found out how easy it is to learn Drafting in spare time at home. Today, I feel secure in my job. What's more, I feel I'm slated for promotion and more pay."

LEARN IN SPARE TIME—AT HOME!

(or at the College in Chicago)

A few hours of pleasant home study every week—that's all. All the tools you need; drawing outfit included. This tested method—developed over 47 years of C.T.C. progress—prepares men quickly for good positions in industry.



FREE INFORMATION — SEND COUPON

To prove to you how easy it is to learn Drafting at home by the Chicago Tech method, we will send you this FREE TRIAL LESSON. No charge for this lesson, now or later. Fill out and mail coupon, or send post card today.

CHICAGO TECHNICAL COLLEGE

A-220 Tech Bldg., 2000 So. Michigan Ave.,
Chicago 16, Illinois

Mail me FREE Lesson with information about big opportunities in DRAFTING.

Name.....Age.....

Address.....

City.....Zone...State.....

PRESTO! ANYONE CAN MASTER GLAZE

LEAVES HARD GLASS-LIKE FINISH
EASY TO APPLY
PROTECTS THE SURFACE
NO SMEAR OR STREAKS AS WITH WAX
LASTS SIX MONTHS TO A YEAR
SEALS THE PORES OF THE SURFACE
WILL NOT FINGER-MARK
NO OILY FILM AS WITH POLISH
EASY TO KEEP CLEAN



SAVES YOU MONEY

Car Owners! Meet Master Glaze—the sensationally different luster for new and used cars! Not a wax—not an oil polish—not a paint!—nothing that "smears" over the surface.

MASTER GLAZE is a unique discovery—a creamy liquid—quick and easy to apply! Gives a hard, glass-like surface. Even gasoline cannot dull it! Lasts six months to a year! Amazing luster—beautiful, sparkling clean and brilliant! Doesn't finger-mark—doesn't smear! A match box full glazes an entire car. Seals the pores—protects! NOTHING LIKE IT!

FREE SAMPLE

Just send your name and address to

MASTER GLAZE CO., 7720-729 W. Harwood Ave., Milwaukee, Wis.



FOAM RUBBER CUT SHAPES

Select from this—one of the largest Foam Rubber stocks—whatever shape or thickness you want—Cut circles or squares for upholstering or padding chairs, mattresses or pads for twin or regular beds, auto seat cushion tops—auto wedges—all new fresh stock—expertly cut to exact size. Lowest prices—satisfaction guaranteed. One day delivery.

Uncovered Foam Pads		Auto Seat Pads	
	1 1/2" thick	24" x 60"	
12" x 14"	\$1.25	1 1/2" thick	\$6.45
16" x 16"	1.35	2" thick	7.95
16" x 22"	1.75	Mattress Pads	
18" x 24"	2.00	Twin size	\$19.55
24" x 24"	2.95	Full Size	23.95

Add 10% to these prices for postage and packing.
No C.O.D. please.....Please print name
Ask for catalog No. 202

RIOR RUBBER COMPANY, Dept. 202
50 E. Cermak Rd. Chicago 16, Ill.

Now Many Wear FALSE TEETH With More Comfort

FASTEETH, a pleasant alkaline (non-acid) powder, holds false teeth more firmly. To eat and talk in more comfort, just sprinkle a little **FAS-TEETH** on your plates. No gummy, gooey, pasty taste or feeling. Checks "plate odor" (denture breath). Get **FASTEETH** at any drug store.

Apache THROWING TOMAHAWK

Balanced to stick

An ancient Indian weapon for killing game - target sport. Easy to throw with our clear instructions.

Splits a 2" board at 30'. Will stick from any angle



Beautiful heavy duty 14" tomahawk. Solid tempered steel. Unusual bargain, limited supply. Sold direct only. Send \$2.98 today to

TECHRITE CORP., Box F12, South Pasadena, Calif.

BOYS-IT'S FREE!

"THE WONDERS OF CHEMISTRY"

This exciting new book shows how to amaze your friends with chemical magic, describes many fascinating home experiments, tells of fun, thrills and big future opportunities for boys who know chemistry. Special atomic energy feature. Send today!

THE PORTER CHEMICAL COMPANY
54 Prospect Avenue Hagerstown, Maryland



FLORIDA

OPPORTUNITY BULLETIN

• The Florida Opportunity Bulletin is an exciting new publication, issued on the 1st & 15th each month and listing hundreds of job openings, business opportunities, farms, groves, city lots, homes, etc. All important areas of the "Sunshine" State covered—Jacksonville, Tampa, Miami. Detailed reports in each issue on employment, trade, real estate. New business & industries are reported, giving names, locations, etc. No other publication like it. Of vital importance in helping you find the right job... buy the right business, farm, grove or home. Let the BULLETIN be your gateway to opportunity, health & happiness. Send only \$1.00 cash, check or money order today for trial subscription next 5 big issues.

FLORIDA OPPORTUNITY BULLETIN
Box 539-PS, MIAMI BEACH, FLA.

Trial
Subscription
5 Issues \$1.00

Satisfaction guaranteed. If not delighted on receipt of first issue your \$1 will be promptly refunded. Act now!

MEN - WOMEN!

Paint it with Suede!

SPRAY ON RAINBOW COLORS

for PROFIT and Pleasure...

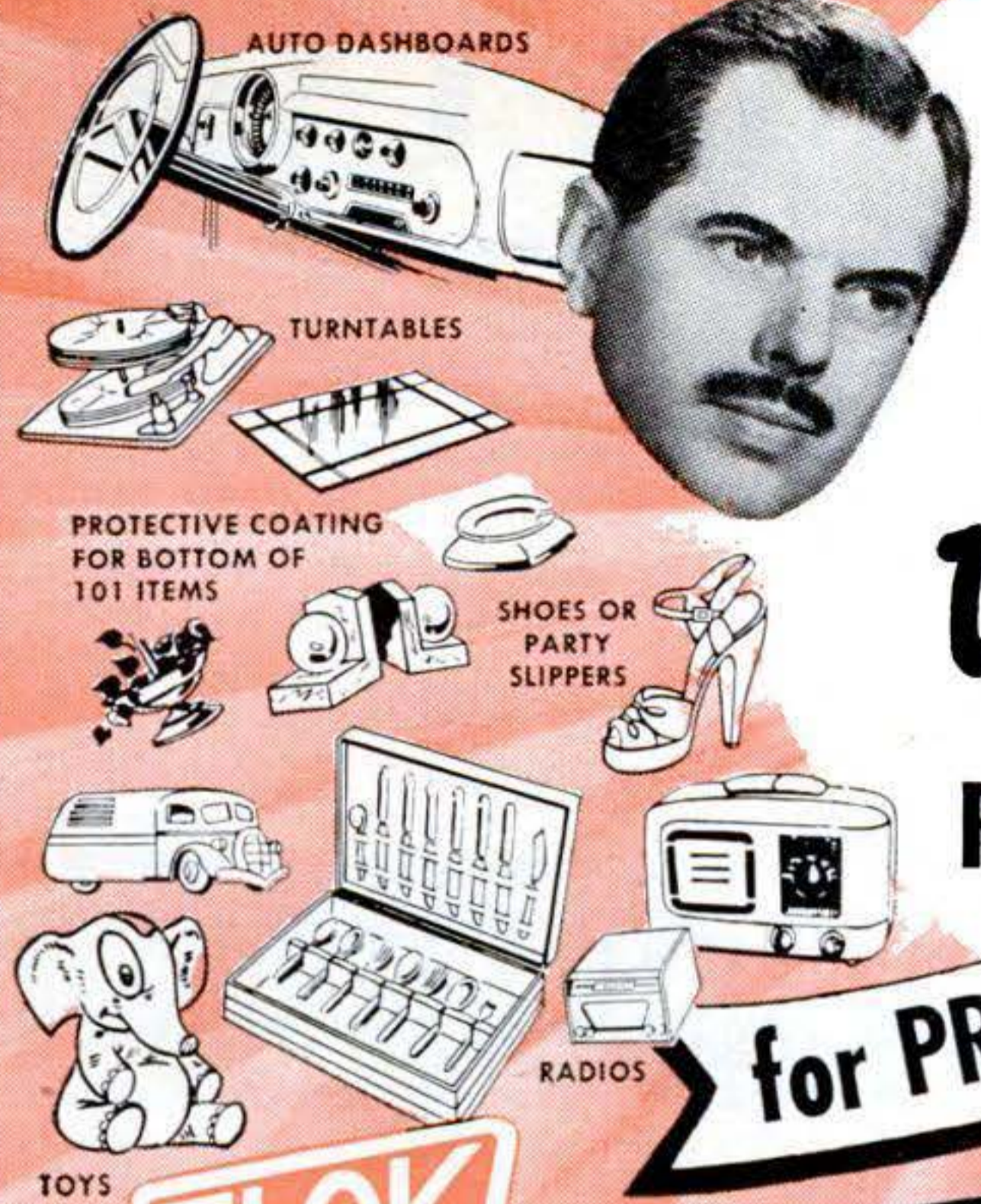

A SENSATIONAL NEW HOME BUSINESS!!
A NEW INDUSTRY... A NEW MIRACLE FINISH!!
MAKE \$500 to \$1000 PER HOUR and more!

Flok-Kraft Covers:
 Fabric, Metal, Glass, Plaster,
 Wood, Plastic or -any surface!

PROFESSIONAL SECRETS CAN BE YOURS

At last the carefully guarded secrets of this amazing miracle finish can be yours. Huge profits are waiting to be tapped in this tremendous new field. Flok-Kraft gives a velvety, luxurious surface to radios, lamps, toys, signs, store displays, figurines, auto dash boards—actually a thousand and one items to be seen on every hand can easily and quickly be beautified, enriched, increased in value with Flok-Kraft. Make old objects beautiful and saleable. Make new things worth more with this soft, rich covering that can be applied to any surface, even if old and worn.

YOU CAN LEARN IN A FEW DAYS

Yes, you can learn in a few days to start making money—big money! Make to \$5.00—yes! even \$10.00 and more per hour. Everything you need is furnished, including fully detailed instructions that are complete and easy to understand. Every point is explained to show you how to start on the road to big money, full or spare time.

WE FURNISH EVERYTHING YOU NEED TO START

In addition to the full step-by-step instructions you get a complete set of materials and equipment that enables you to start at once. A few cents worth of materials can mean many dollars in returns to you. You can make big profits, spare or full time—add to your income from your regular job or begin to build your own successful future with a full time business of your own and do it all right in your own home! A corner of your basement, garage, service porch, kitchen or living-room is all the space you need to start.

GRASP THIS LIFETIME OPPORTUNITY TODAY

This is one too good to miss. Fill out the coupon below and mail it today for full free details. I'll arrange to send you the complete outfit—everything you need to start—for leisurely, no-risk examination right in your own home. You owe it to yourself to investigate. Write now for full, free details, samples, etc. Fill out and mail the coupon below. Do it today! Everything I send you is FREE.

SEND NO MONEY—MAIL COUPON NOW!

COAST INDUSTRIES, Dept. 11
 1004 S. Los Angeles St., Los Angeles 15, California
 Gentlemen:
 Please rush me FREE details, sample, etc., I understand that everything you send is free and that I'll be under no obligation now or ever.

NAME _____
 STREET _____
 CITY _____ STATE _____

Read What Others Say About Flok-Kraft

"Received the flok-kraft outfit and everyone that saw it is very enthused. I only had it about thirty minutes and got an order for a hundred dollar job." Mr. C. H. Maryland.



"... I have received my order of Flok and Adhesives and believe me, I'm very pleased and happy as I've made myself MORE than the cost of my supplies already, and I've still got more jobs to do." Cpl. G. W., S. Carolina



"Got \$52.50 for those 7 trunk interiors for about 4 hours work. \$7.50 per trunk." J. O., Mo.



"... pleased with your course and I'm being swamped with work to do." W. F.,



YOURS TO EXAMINE WITHOUT RISK!!

Examine in your own home—then decide. The complete instructions, the full starting kit of materials and equipment and full details on how you can open your own business, spare or full time—EVERYTHING will be sent you to EXAMINE AT OUR RISK!

FLOK-KRAFT and DEFENSE

This amazing miracle finish is of inestimable value for use on hundreds of defense products. Flok-Kraft offers you a way to big, extra money, assisting manufacturers in many lines as well as filling a big demand on the home front.

FREE! Booklet, Sample, Plan!



Coast Industries, Dept. 11
 1004 Los Angeles St., Los Angeles 15, Calif.

PICTURE BOOKLET  SENT FREE

CONVAIR

in Sunny San Diego

has a **JOB** for you:

OPPORTUNITIES NOW OPEN:



- 1 TOOL DESIGNERS
- 2 TOOL PLANNERS
- 3 PATTERN MAKERS
- 4 TOOL & DIE MAKERS
- 5 JIG & FIXTURE BUILDERS
- 6 MACHINISTS
- 7 LOFTSMEN

San Diego offers you California living at its best — and Convaair gives you the top working conditions. Employee Retirement Plan. Group Insurance. Two weeks vacation Eight holidays annually Free Housing Office and much more — plus that wonderful San Diego climate.

Send this coupon now for booklet, details and Application Blank

Employment Office
Consolidated Vultee Aircraft Corporation Dept. 600
3302 Pacific Hiway
San Diego, California

NAME _____

OCCUPATION _____

ADDRESS _____

CITY _____ STATE _____

Amazing Invention Defrosts Refrigerators *AUTOMATICALLY*

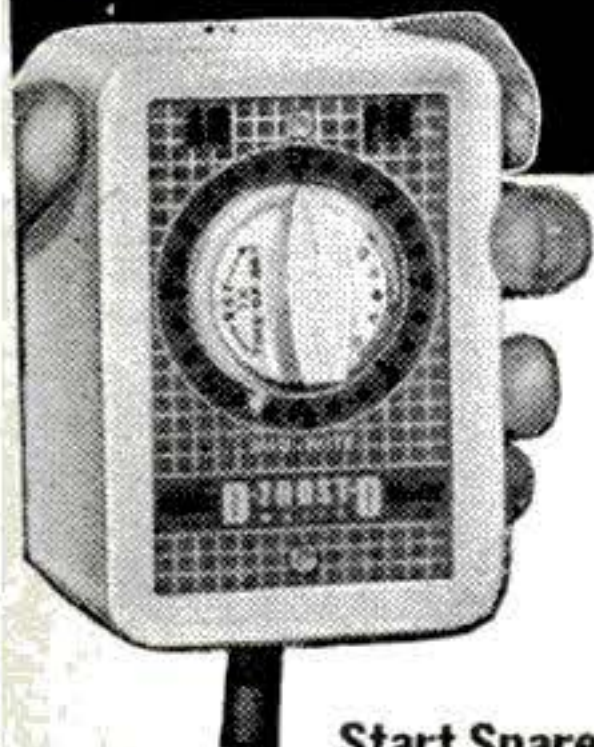

**Pays Salesmen Up To
\$210.00 a Week!**

No wonder our salesmen are getting so rich and happy, with 29,000,000 eager prospects for the sensational Patented D-Frost-O-Matic that defrosts refrigerators Every Night without much fuss or bother. Saves electricity, wear on refrigerator, food and work. You, too, should make up to \$210.00 a week on our FREE TRIAL plan that clinches up to 4 orders out of 5, paying you up to \$7.00 each.

Start Spare Time

Yes, just a few hours in an evening should pay you up to \$18.00 PROFIT! Just plug in D-Frost-O-Matic—women won't let you take it out.

Profits Guaranteed. You take no risk. Getting a flying start in this business will not cost you one red cent, unless YOU agree that it is the most fascinating, best-paying proposition you ever heard of! Rush name and address on postcard TODAY for generous FREE TRIAL plan.



END THIS FOREVER

D-FROST-O-MATIC

Dept. D-14, 6 N. Michigan, Chicago

Develop Hidden Earning Power

STUDY LAW

at home! LL.B. Degree

Qualify yourself in spare time for advancement, greater earnings, business success. Now, more than ever, legal ability is in demand! Easy-to-understand step-by-step lessons and text material furnished—invaluable for permanent reference. 42 years expert teaching. 114,000 students enrolled. Easy payments. Find out now, at no cost, how study of law can help you. Write today for FREE Book "Law and Executive Guidance."

AMERICAN EXTENSION SCHOOL OF LAW

Dept. PS-46 646 N. Michigan Ave. Chicago, Ill.

LEARN — Trades that Pay More

WATCHMAKING or ENGRAVING

Trades You Enjoy — by HOME STUDY

WRITE TO

Don't let a lay-off catch you. START NOW TO LEARN THESE HIGH-PAYING TRADES IN YOUR SPARE TIME. Earn extra money as you learn, repairing clocks and watches, or engraving silver and jewelry. YOU WILL BE BUILDING YOUR OWN BUSINESS RIGHT AT HOME.

KANSAS CITY SCHOOL OF WATCHMAKING

Admiral & Tracy Blvd. - Kansas City 6, Mo.

New Way to Improve YOUR ENGLISH



A command of effective English gives you added advantages and better opportunities. Poor English handicaps you more than you will ever realize. You can improve your English through Sherwin Cody's 100% self-correcting invention.

If you are ever embarrassed by mistakes in grammar, spelling, punctuation, or pronunciation, this new free book "How You Can Master Good English in 15 Minutes a Day" will prove a revelation to you. Send for it now. It is free. No obligation. No agent will call. Address **SHERWIN CODY COURSE IN ENGLISH, 181 B & O Building, Rochester 14, N. Y.**



PHOTOGRAPHY

EARN BIG MONEY! PERSONAL ATTENDANCE TRAINING in News-Magazine-Fashion-Portrait-Advertising-Natural Color Photography. Splendid equipment, glamorous models. Or — our **COMPLETE HOME STUDY COURSE** provides you with a spare time short-cut to success.

Our 42nd year. Write immediately for **BIG FREE BOOK!**

NEW YORK INSTITUTE OF PHOTOGRAPHY

Dept. 5, 10 West 33 St., New York 1, N. Y.

Piles May Lead to Chronic Ailments

FREE BOOK—Explains the Causes and Effects

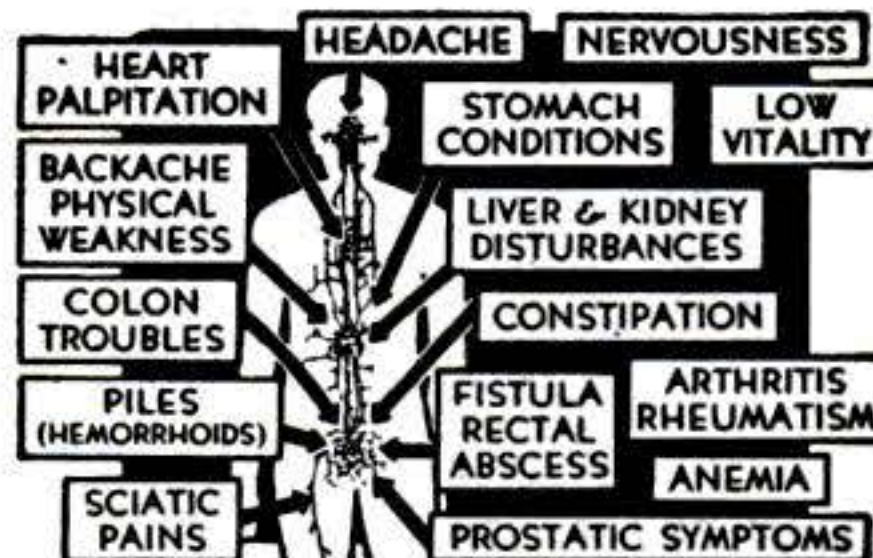

No obligation. Write to Thornton & Minor Hospital, Suite 149, 911 E. Linwood, Kansas City 3, Mo.



Let Us Put This Magnificent New 1952

MIDWEST TELEVISION

CONSOLE With Its MAMMOTH

20-Inch

PICTURE TUBE
IN YOUR HOME ON
30 DAYS TRIAL



FACTORY-TO-YOU

You be the judge! See and hear Mammoth-Picture Midwest Television right in your own home for 30 days. If you are not 100% satisfied, any money you have paid will be promptly refunded. Send today for the new 1952 catalog of the finest Midwest line in 32 years.

We Pay Transportation Charges

LOW FACTORY PRICES

Special Bonus

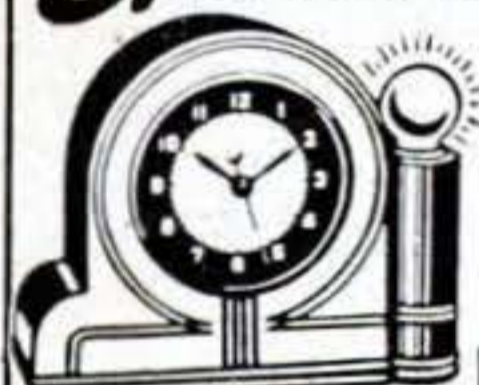

GIFT!

**Illuminated
TELEVISION CLOCK**

Given With Every
Purchase of a MIDWEST
RADIO or TELEVISION
LIMITED TIME ONLY!

MIDWEST 20-Inch TELEVISION CHASSIS

Ready for easy installation in
your own cabinet.

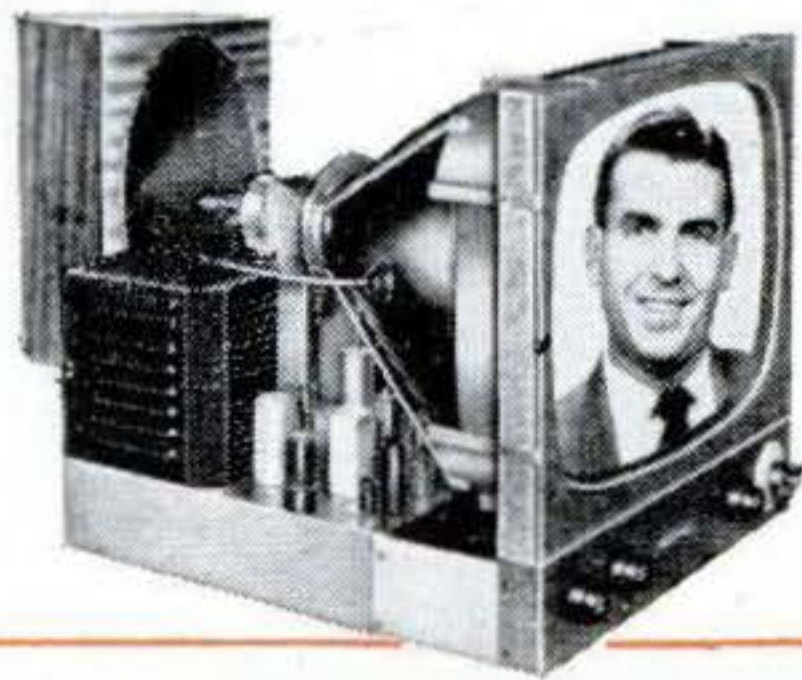

EASY TERMS

WRITE or PHONE
For This NEW 1952
**FREE MIDWEST
TELEVISION
RADIO CATALOG**



If You Live In One of These Cities
Phone and Ask for Your Catalog

NEW YORK MURRAY Hill 2-6810
CHICAGO State 2-5600
PITTSBURGH GRant 1-0609
CLEVELAND PROspect 1-7450
DETROIT WOODward 3-1233
ST. LOUIS GRand 1161
PHILADELPHIA LOCust 4-1035

or Send Coupon Below

• **WRITE IN NAME AND ADDRESS (PLEASE
PRINT) ON COUPON OR 1c POSTCARD** •

MIDWEST RADIO & TELEVISION CORP.
Dept. 246, 909 BROADWAY • CINCINNATI 2, OHIO

Please send me your new FREE 1952 Catalog.

NAME _____

ADDRESS _____

CITY _____ ZONE _____ STATE _____

Also—Powerful New 1952 World-Ranging MIDWEST Series of RADIOS

For Beautiful Consoles and Complete Chassis



An entirely new line of
radios featuring the
powerful Series 16 five
wave band AM-FM
Radio Chassis and the
magnificent Symphony
Grand Radio-Phonograph
with 3-Speed Automatic
Intermix Record Player.

Easy Terms



MIDWEST RADIO & TELEVISION CORP.
DEPT. 246, 909 BROADWAY, CINCINNATI 2, OHIO

CUT-TO-FIT HOMES CUT BUILDING COSTS

CHOICE OF 57 DESIGNS

ORDER NOW

SAVE UP TO 1/3



Build your own home and save the builders' profit—plus savings in lumber and labor with Sterling Ready-Cut-Homes. Anyone can assemble with simple, easy to follow plans furnished. Every house complete with all lumber, roofing, nails, glass, hardware, paint, doors and windows marked ready to erect. Freight paid. Complete building plans ready for filing at low cost. Sold separately if desired. Write today!

PRICED FROM \$2150 up
Five Easy Payment Plans

Send 25c for NEW COLOR CATALOG

INTERNATIONAL MILL AND TIMBER CO.
DEPT. P.S. 12 BAY CITY, MICHIGAN

MAKE EXTRA MONEY

PLASTICS LEARN AT HOME

LEARN HOW TO MAKE fast selling PLASTIC NOVELTIES FURNITURE JEWELRY SIGNS TOYS LAMPS

There are RICH OPPORTUNITIES for MEN and WOMEN with "know-how" in Plastics. Interstate's amazing new Plastics course tells and shows how to make hundreds of fast selling items out of Plastics. Gives complete training in fabrication, casting, lamination, molding, etc., in simple, easy, step-by-step language and pictures.

START A PLASTICS BUSINESS OF YOUR OWN. No other industry holds such promise for the future. You can make big money manufacturing novelties, toys, signs, etc., in your own home in spare or full time. Don't wait! Learn NOW how Interstate's Plastics Training qualifies you for success in the plastics field.

Write for FREE Information Today!

INTERSTATE TRAINING SERVICE

School of Plastics, Dept. C2A
PORTLAND 13, OREGON

ELECTRIFY your SEWING MACHINE

NEW LOW PRICE! \$11.50 1 YR. GUARANTEE



Buy direct from manufacturer and save! Kit comes fully wired, installed in a jiffy. Fits all machines! You get ALL-NEW PARTS!

- Motor & Bracket
- AC-DC 115v 60c
- Multi-speed foot control
- Cord set & block
- Easy instructions
- Steel pulley & belt

FREE . . . reg. \$2.95 chrome SEWLITE given with every kit.

10 DAY FREE TRIAL — ORDER NOW!

Send no money, pay COD or send money order and we'll pay postage. Please state whether wheel on your machine turns toward you or away from you. Shipping wt. 6 lbs.

SENIOR SEWING MACHINE CO.

1046 BEDFORD AVENUE, Dept. PS-33, BROOKLYN 5, N. Y.

TAKE THE STEPS NOW THAT WILL GIVE YOU LIFETIME SECURITY IN AVIATION!



Booming aviation industry urgently needs properly trained young men! Big paying jobs are open right now, with more to come! Embry-Riddle offers maximum training in minimum time. Fully accredited 8-mo. to 26-mo. courses in all aeronautical phases. Job-fitting instruction backed by 25 yrs. experience training today's aviation leaders. Be prepared.

Enroll now! Illustrated catalog, address:

REGISTRAR, EMBRY-RIDDLE, DEPT. 99, MIAMI 30, FLA.



Embry Riddle

NOW IS THE TIME

PILES

If you suffer the miseries of itching, bleeding or protruding piles, you may have a generous supply of Page's Palliative Pile Preparation absolutely free for the asking. These preparations have relieved pile suffering in hundreds and thousands of cases for over 60 years.

FREE Trial supply to quickly prove all this, will be sent absolutely free with no obligation to buy now or later. Send your name and address for your free trial TODAY!

E. R. PAGE CO., Dept. 45H-1 Marshall, Mich.



12 Months Driving for \$4.95

A new tire guarantee with each used tire. Positively Not Re-Caps—Every Tire Machine Inspected

600-16 \$4.95 Two for \$9.50 650-16 \$5.50
670-15 \$5.95 700-15 \$5.95

Send this ad with order. Mail orders rushed on receipt of check or money order for the size desired.

Dept. A
West Park Tire Sales, 14018 Beech Ave., Cleveland, O.



MARVEL Mystery Oil

- Frees Sticky Valves
- Stops Hydraulic Valve Clatter

Buy it at your favorite gas station

ALL PURPOSE ELECTRIC TESTER

You can locate your electrical troubles INSTANTLY with the NEW VEST POCKET ALL PURPOSE ELECTRIC TESTER. IT PROBES. . . . IT TESTS. . . . IT LIGHTS. . . . IT SAVES on all electric repairs. The patented TEST LIGHT traces, then BEAMS on disorders in appliances, circuits, motors, tools, receptacles and EVERYTHING ELECTRICAL, for home, factory, and farm. Tests continuity, shorts and grounds from 110 to 600 Volts. No batteries required. Ready-to-use, 2½ oz. complete, pocket-size, 6 ft. high-test flexible plastic insulated test cord, with patented plastic case and complete instructions. Fully guaranteed.

SAFE! SWIFT! SURE!

Order TODAY—only \$2.98 postpaid, or pay postman \$2.98 plus delivery charges.

IMPERIAL SALES CO., 480 Lexington Ave., Dep't. 078, New York, N. Y.

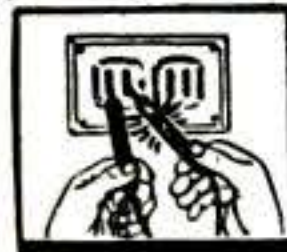

RECEPTACLE TEST

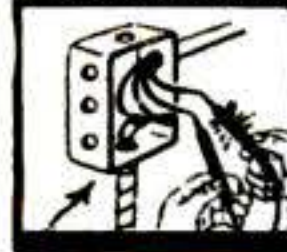

MOTOR CHECK

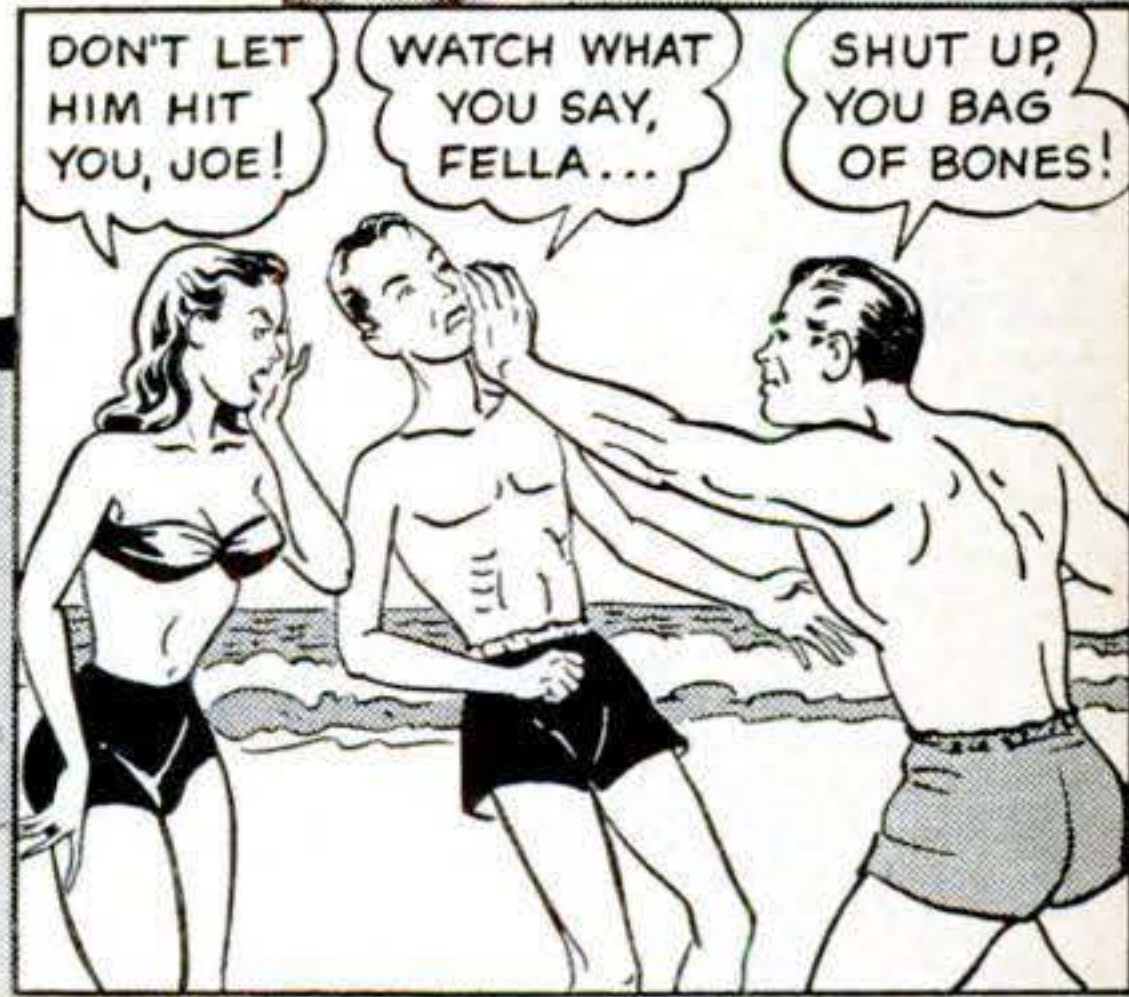
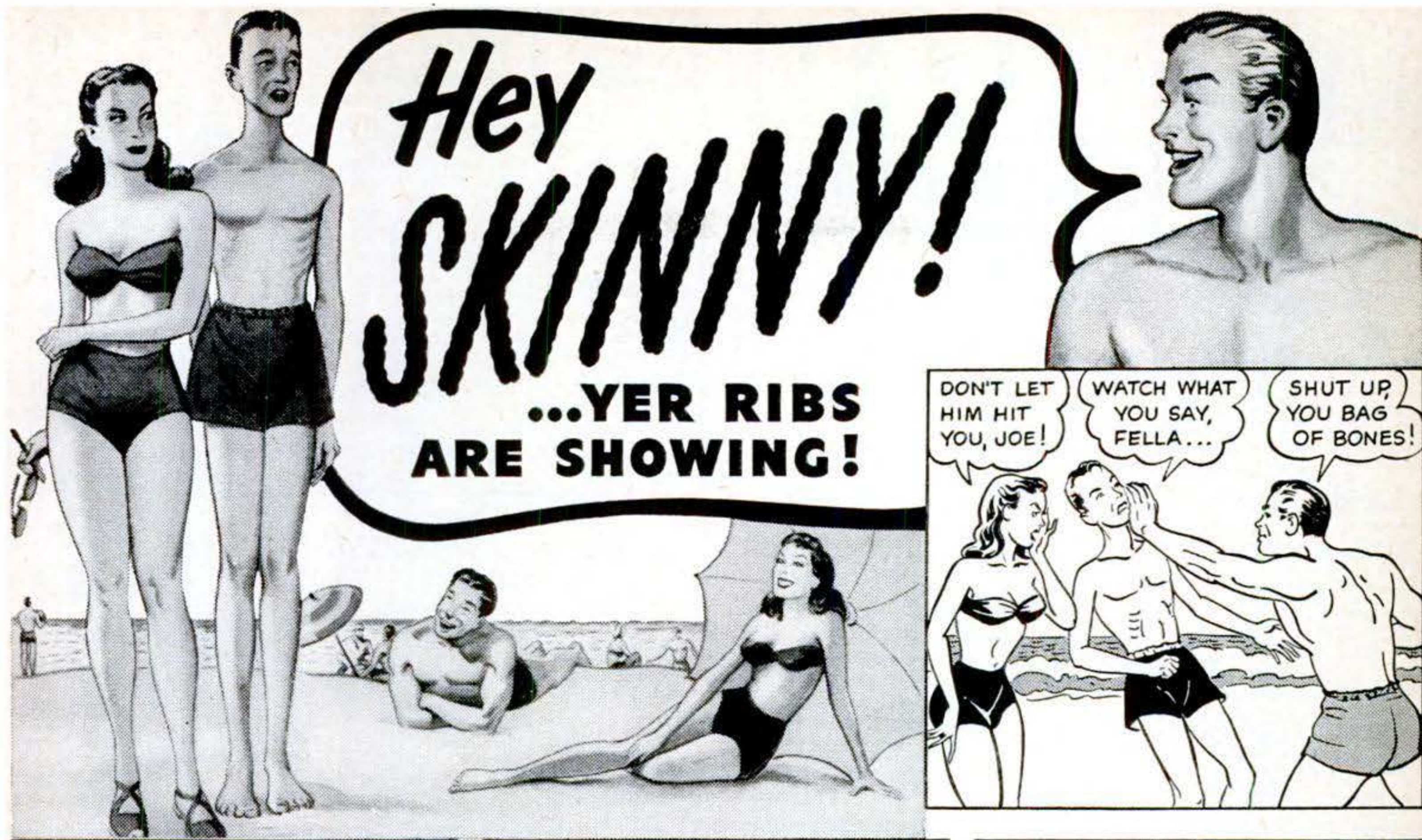

I Can Make YOU a New Man, Too, In Only 15 Minutes a Day!

CHARLES ATLAS
Holder of title, "The World's Most Perfectly Developed Man."

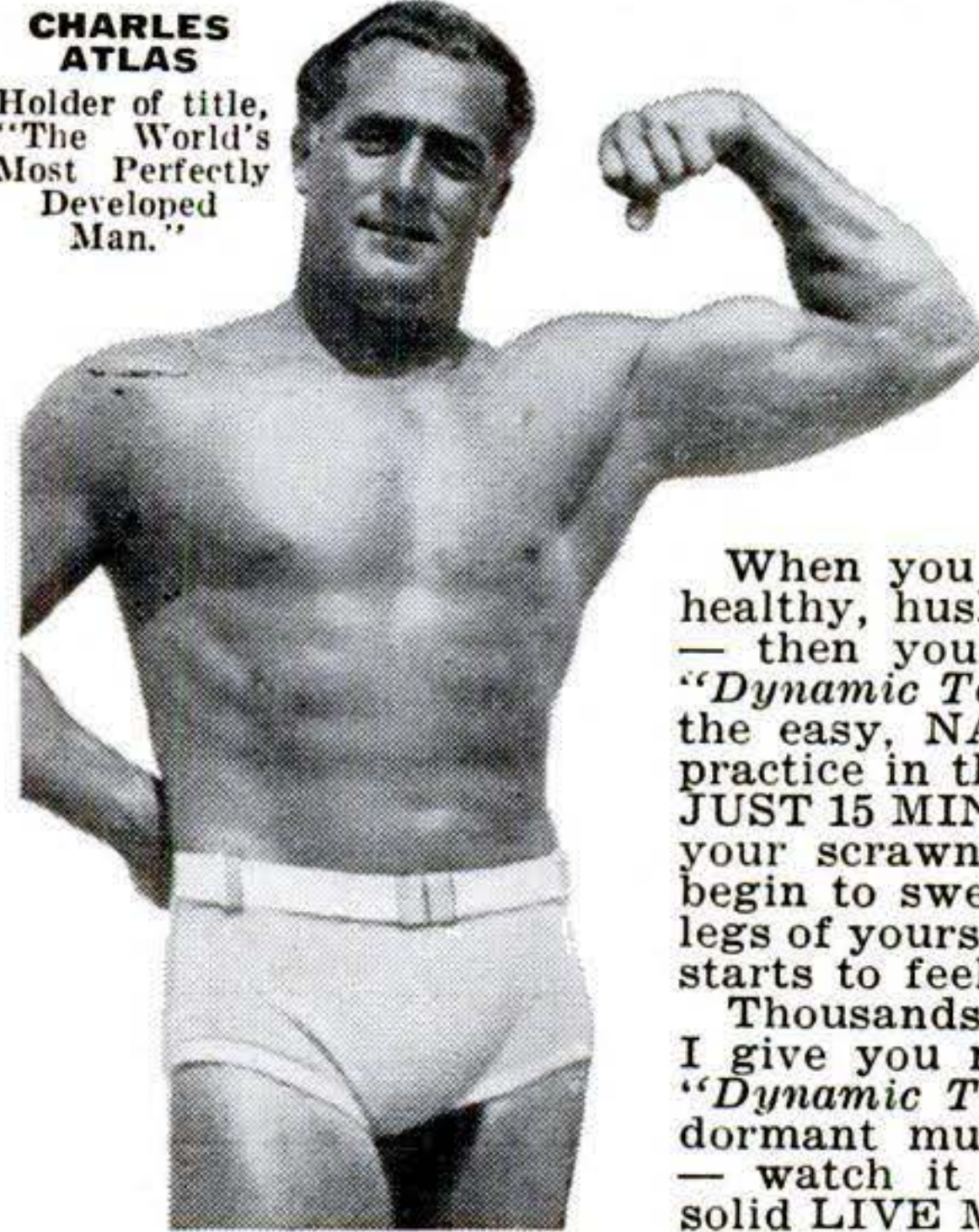

PEOPLE used to laugh at my skinny 97-pound body, I was ashamed to strip for sports or for a swim. Girls made fun of me behind my back. THEN I discovered my body-building system, "Dynamic Tension." It made me such a complete specimen of manhood that I hold the title, "The World's Most Perfectly Developed Man."

What's My Secret?

When you look in the mirror and see a healthy, husky, fellow smiling back at you — then you'll be astonished at how fast "Dynamic Tension" GETS RESULTS! It is the easy, NATURAL method and you can practice in the privacy of your own room—JUST 15 MINUTES EACH DAY. Just watch your scrawny chest and shoulder muscles begin to swell . . . those spindly arms and legs of yours bulge . . . and your whole body starts to feel "alive," full of zip and go!

Thousands are becoming husky—my way. I give you no gadgets to fool with. With "Dynamic Tension" you simply utilize the dormant muscle-power in your own body — watch it grow and multiply into real, solid LIVE MUSCLE.

FREE My 32 Page Illustrated Book is Yours — Not for \$1.00 or 10c—But FREE

Send for my book, *Everlasting Health and Strength*. 32 pages of photos, valuable advice. Shows what *Dynamic Tension* can do, answers vital questions. A real prize for any fellow who wants a better build. I'll send you a copy FREE. It may change your whole life. Rush coupon to me personally: Charles Atlas, Dept. 1N, 115 E. 23rd Street, New York 10, N. Y.



**CHARLES ATLAS, Dept. 1N,
115 East 23 St., New York 10, N. Y.**

Send me—absolutely FREE—a copy of your famous book, *Everlasting Health and Strength*—32 pages, crammed with photographs, answers to vital questions, and valuable advice. This book is mine to keep, and sending for it does not obligate me in any way.

Name.....Age.....
(Please print or write plainly)

Address.....

City.....State.....

Copyrighted material



AUTO BOOKS ON APPROVAL



CAN YOU FIX IT?

These wonder books tell step by step HOW to make difficult repairs and adjustments, how to keep a car at maximum efficiency, including latest improvements in car design and operation. Engine troubles and how to correct them well covered.

4 BIG, THICK VOLUMES Over 2700 pages, 2000 illustrations, wiring diagrams, etc. Beautiful modernistic, washable cloth binding.

AMERICAN TECHNICAL SOCIETY, Dept. A120
Drexel Ave., at 58th St., Chicago 37, Ill.

I would like to examine your 4 Volume Set of Auto Books. I will pay the delivery charges only, but if I choose I may return them express collect. If after 10 days' use I prefer to keep them, I will send you \$3 and pay the balance at the rate of only \$4 a month until \$24.80 has been paid. Include consulting service as offered above.

Name.....

Address.....

City..... State.....

Please attach letter stating age, occupation, employer's name and address, and name and address of at least one business man as reference. Men in service, also please give home address.

SEND NO MONEY. Just mail the coupon for a complete set of 4 Big, Thick Auto Books, 20th Edition. Over 2700 Pages! Whether you are a mechanic or helper, expert or apprentice, auto owner or driver, take immediate advantage of this **FREE EXAMINATION OFFER.**

MAKE GOOD MONEY NOW HOLD A PERMANENT JOB

America wants its automobiles kept in good repair. Men with "know how" are in demand, at big pay. These books will help you get and hold an important job, or give you a chance to go into business for yourself now or later. Any man who half tries to improve himself can learn auto servicing and repairing by this quick reference method. Use the **JIFFY INDEX** to find easily understood answer to any auto problem. These wonder books prepared by eleven of America's great automobile engineers. Many hundreds of valuable illustrations. Send the coupon **TODAY.**

[A year's consulting privileges with our engineers now given with these books without extra charge.]

Publishers Since 1898

NOW YOU TOO CAN BUILD 15 RADIOS

COMPLETE KIT \$19.95



The Progressive Radio "Edu-Kit" is a Home Radio Course in kit form. No previous knowledge of radio is required. No additional parts necessary. Tools included. Easy-to-follow instructions. Theory, Practical Work, Trouble-shooting are taught. Used in many radio schools. Excellent background for television.

Kit includes all parts, instructions, radio tester, electric soldering iron, trouble-shooting guide, quizzes, television book, consultation service. \$19.95 is complete price. Nothing else to buy. Everything you build is yours to keep. All parts and equipment guaranteed.

Order your kit today, or send for further information. You risk nothing. 10 Day Money-Back Guarantee.

Postage prepaid on cash orders. C.O.D. orders accepted in U.S.A.

PROGRESSIVE ELECTRONICS CO.

497 Union Ave., Dept. P.S. 4

Brooklyn 11, N. Y.

Malayan THROWING DAGGER

BALANCED TO STICK! \$1.98 postpd

This MALAYAN FIGHTING KNIFE is used for self-defense, killing game, target skill. Powerful, silent, accurate weapon. Splits 1" board at 30 ft.



Fun, Thrills, Excitement!

Indoors—outdoors. Learn this Sport! Easy

to throw accurately with our

clear instructions. Beautiful, heavy-

duty 10" knife. Tempered steel. Tough,

rawhide-bound handle. Rare souvenir, unusual

bargain. Limited quantity. At dealers or send \$1.98

WHOLESALE IMPORT CO. Dept. B, 604 Marengo, Alhambra, Calif.



LEATHERCRAFT PATTERNS & KITS

Complete stock of high quality leathercraft supplies. **4 new handbag patterns**—tracings—photo patterns—and complete instructions—\$1.50 postage prepaid.

Send 25c for new catalogue (Refunded with first order)

APACHE LEATHER CO.

Dept. PSX5

2804 E. Washington St., Phoenix, Arizona

"I'M MAKING MORE THAN \$1000 a Month Haven't Touched Bottom Yet!"



C. KAMA

—reports Charles Kama, Texas, one of many who are "cleaning up" with orders for **PRESTO**, Science's New Midget Miracle Fire Extinguisher. So can YOU!

AMAZING new kind of fire extinguisher. A Tiny "Presto" (about size of a flashlight!) does job of bulky extinguishers that cost 4 times as much, are 8 times as heavy. Ends fires fast as 2 seconds. Fits in palm of hand. Never corrodes. **Guaranteed for 20 years!**

Show it to civil defense workers, owners of homes, cars, boats, farms, etc. and to stores for re-sale—make good income. H. J. Kerr reports \$20 a day. Wm. Wydal-lis, \$15.20 an hour. Write for **FREE** Sales Kit. No obligation. **MERLITE INDUSTRIES, Inc., Dept. 111, 201 East 16th St., New York 3, N.Y. IN CANADA: Mopa Co., Ltd., 371 Dowd St., Montreal 1, P.Q.**

(If you want a regular Presto to use as a demonstrator, send \$2.50. Money back if you wish.)



Science's New Midget Miracle "PRESTO"

Learn UPHOLSTERING

FOR FULL OR SPARE TIME PROFIT

Easy to learn at home! Easy to start a shop, or earn spare-time profits! Complete tool set, all materials to build ottoman, included with lessons. Low terms. Write for valuable booklet today!

COMMERCIAL TRADES INSTITUTE
1400 Greenleaf Ave., Dept. UI-1, Chicago 26, Ill.

Buy U. S. Defense Bonds

If Ruptured



CAN YOU HOLD BACK YOUR RUPTURE LIKE THIS?

If You Can then Don't Delay Another Day—for now it can be controlled with Freedom and Comfort in every normal day and night activity.

ENTIRELY DIFFERENT Will mail in plain sealed envelope.

FRED B. MILLER
MANUFACTURER

DEPT. P, HAGERSTOWN, MARYLAND

Write me Today For **FREE** Descriptive Circular

THOUSANDS NOW PLAY

who never thought they could!



After Ten Months Plays in Band

I had no idea I would accomplish so much musically. After only ten months I was playing in bands. I now am employed in a music store as an instructor. This I owe to your marvelously simple lessons.

*R. C., Paterson, New Jersey



Wouldn't Take \$1000 for Course

The lessons are so simple that anyone can understand them. I have learned to play by note in a little more than a month. I wouldn't take a thousand dollars for my course.

*S. E. A., Kansas City, Mo.



Shares Course With Sister

The teaching is so interesting and the pieces so beautiful I couldn't ask for anything better. I recommend your course highly. My sister shares it with me and feels the same way.

*D. E. G., Wausau, Wisc.



Lots of Fun

The progress I have made is thrilling. I'm on Lesson Seven and tossing off "Little Buttercup" like a maestro. The course is easy and what is most important—lots of fun.

*B. B., Jr., Hartford, Connecticut



Plays After 2 Months

I hesitated before sending for your course because of an earlier experience I had with a course by ear from another company. I am playing pieces now I never dreamed I would play after only two months.

*E. T., Prichard, Ala.

*Actual pupils' names on request. Pictures by professional models.

You, too, can play any instrument By this EASY A-B-C Method

YOU think it's difficult to learn music? That's what thousands of others have thought! Just like you, they longed to play some instrument—the piano, violin, guitar, saxophone or other favorites. But they denied themselves the pleasure—because they thought it took months and years of tedious study to learn.

Learn in Spare Time at Home

And then they made an amazing discovery! They learned about a wonderful way to learn music at home—without a private teacher—without tedious study—and in a surprisingly short time. They wrote to the U. S. School of Music for the facts about this remarkable short-cut method. And the facts opened their eyes! They were amazed to find how easy it was to learn.

The result? Over 850,000 men and women have studied music at home this simple, A-B-C way. Now, all over the world, enthusiastic music-lovers are enjoying the thrilling satisfaction of creating their own music. They have found the key to good times, popularity and profit.

Costs Only Few Cents a Day

And that's what **you** can do, right now. Get the proof that you, too, can learn to play your favorite instrument—quickly, easily, in spare

time at home for only a few cents a day. Never mind if you have no musical knowledge, training or talent. Just read the fascinating booklet and Print and Picture sample that fully explain all about the famous U. S. School method. Instruments supplied when needed, cash or credit. If interested tear out the coupon now, before you turn the

page. U.S. School of Music, Studio B151, Port Washington, N.Y. (54th year)

FREE!

Print and Picture
Sample



NOTICE!

Please don't confuse our method with any systems claiming to teach "without music" or "by ear." We teach you easily and quickly to play **real music**, any music by standard notes—not by any trick or number system.

**U. S. SCHOOL OF MUSIC,
Studio B151, Port Washington, N. Y.**

I am interested in music study, particularly in the instrument checked below. Please send me your free illustrated booklet "How to Learn Music at Home," and your free Print and Picture Sample. (Instrument supplied when needed, cash or credit.)

- | | | | |
|--|--------------------------------------|---|------------------------------------|
| <input type="checkbox"/> Piano | <input type="checkbox"/> Saxophone | <input type="checkbox"/> Clarinet | <input type="checkbox"/> Practical |
| <input type="checkbox"/> Guitar | <input type="checkbox"/> Trumpet. | <input type="checkbox"/> Trombone | <input type="checkbox"/> Finger |
| <input type="checkbox"/> Hawaiian | <input type="checkbox"/> Cornet | <input type="checkbox"/> Flute, Piccolo | <input type="checkbox"/> Control |
| <input type="checkbox"/> Guitar | <input type="checkbox"/> Organ | <input type="checkbox"/> Modern | <input type="checkbox"/> Mandolin |
| <input type="checkbox"/> Violin | <input type="checkbox"/> Tenor Banjo | <input type="checkbox"/> Elementary | |
| <input type="checkbox"/> Piano Accordion | <input type="checkbox"/> Ukulele | <input type="checkbox"/> Harmony | |

Mr. _____
Mrs. _____ Have you
Miss _____ (Please print) Instrument? _____

Address _____

City _____ State _____

NOTE: If you are under 16 years of age, parent must sign coupon.

U.S. GOVERNMENT JOBS

START \$3,450.00 YEAR OR MORE

Many 1952 Examinations Expected. Prepare NOW! Veterans Get Special Preference! 32-Page Civil Service Book FREE Mail Coupon Today SURE ★

Franklin Institute
(Not Government Controlled)
Dept. D-81,
Rochester 4, N. Y.

Gentlemen: Rush to me, FREE of charge, list of U. S. government big pay jobs. Send FREE 32-page book describing salaries, vacations, hours, work, etc. Tell me how to qualify for one of these jobs.

COUPON
Name.....
Street.....
City..... Age?.....



MEN! send for this MONEY-MAKING OUTFIT FREE!

MAKE \$15.00 IN A UP TO DAY

Do you want to make more money in full or spare time . . . as much as \$15.00 in a day? Then mail coupon below for this BIG OUTFIT, sent you FREE, containing more than

150 fine quality fabrics, sensational values in made-to-measure suits and overcoats. Take orders from friends, neighbors, fellow-workers. No experience needed. You'll say it's the greatest way to make money you ever saw.

SAMPLE SUITS TO WEAR Pay No Money! Send No Money!

Our plan makes it easy for you to get your own personal suits and overcoats without paying 1c, in addition to your big cash earnings. This offer is limited. Rush coupon for FREE OUTFIT—today!

STONE-FIELD CORP., Dept. B-820 532 S. Throop St. Chicago 7, Ill.

STONE-FIELD CORP., Dept. B-820
532 S. Throop St. Chicago 7, Ill.

Dear Sir: I WANT A SAMPLE SUIT TO WEAR AND SHOW, without paying 1c for it. Rush Valuable Suit Coupon and Sample Kit of actual fabrics, ABSOLUTELY FREE.

Name..... Age.....
Address

City..... State.....

U. S. GOV'T SURPLUS
"BARGAIN BOOK"

SAVE ON WINTER NEEDS!
It's loaded with bargains in genuine Gov't Surplus for farm-home-industry. Save up to 85% on clothing, hardware, sporting goods, etc. The "Book of the year". Send 10c for yours today.

500 BARGAINS
• FARMS • SPORTS
• HOME • SHOP

MAIL TODAY Only **10¢**

FISLER SALES CO.
723 WALNUT ST., DESK 51, KANSAS CITY, MO.

Opportunity OF A LIFETIME!
SELL AIR CUSHION SHOES



Write for FREE catalog today!

Build a permanent "repeat" business of your own without one penny of investment! Sell John Neil Air-Cushion Shoes Direct from famous New England factory. Firestone Foamex cushions — complete line of men's dress, work, safety shoes! DuPont Neoprene non-marking soles, Women's and children's shoes. Fast deliveries from our mammoth stock department.

Earn up to \$30.00 per day!
JOHN NEIL SHOE CO.
DEPT. 14—Brockton 64, Mass.

A "GOOD HAND" HELPS YOU SUCCEED!
LEARN TO WRITE WELL

Write Your Name
beautifully written, plus special pen-point for shaded writing. Only 10¢

Handwriting quickly improves with our easy-to-understand picture lessons! Put your spare time to good use; send today for FREE BOOK, "How to Become a Good Penman", or check volumes wanted below at \$1 each: Business Writing Artistic Writing Card Writing Bird & Design Flourishing Engrossing Alphabets. COMPLETE SET \$4.50

OUR 53rd YEAR
TAMBLYN SCHOOL of PENMANSHIP
S. A. Ziller, Pres. 438 Ridge Bldg., Kansas City, Mo., USA

Learn MECHANICAL DENTISTRY

A profession offering unlimited opportunities. Most modern and complete course embracing every branch from Plate to Porcelain Work, which prepares you to work for Dentists or start your own business. Individual instruction—practical training in day or night school. No books—no classes. Catalog upon request.

McCARRIE SCHOOL of Mechanical Dentistry
207 N. Broad Street Dept. 919 Philadelphia, Pa.

Sensational Device Tests Eyes



SAVE up to \$15.00 on Glasses!
Big news to the millions of Spectacle Wearers and Prospects. Means Freedom from Outrageous Prices. Sold on Money-back Guarantee.

MAKE BIG MONEY QUICK—FREE SAMPLE KIT!
Show it to friends and others. Let them use it Free and watch their amazement over this Self Testing system. Here is a great new opportunity in a tremendous new field of unlimited possibilities. Spare or full time. No experience needed. Write for Free sample kit.
C. G. Optical Co., Dept. A-115, 20 E. Delaware Pl., Chicago 11, Ill.

VOTE TODAY

FOR THE FUTURE YOU WANT!

AMERICAN SCHOOL, Dept. G146, Drexel at 58th, Chicago 37, Ill.
Without obligation, please send FREE and postpaid, full particulars about the subject checked below.

- Accounting
- Air Conditioning
- Architecture & Building
- Automotive Technician
- Better Foremanship
- Bookkeeping
- Business Management
- Contracting
- Diesel Technician

- Drafting—Building Trades
- Drafting—Machine Trades
- Electrical Engineering
- Electricity—Practical
- Electronics—Industrial
- High School Courses
- Machine Shop Operations
- Mathematics & Slide Rule
- Mechanical Engineering

- Plastics Engineering
- Plumbing—Practical
- Private Secretary
- Refrigeration
- Retail Merchandising
- Salesmanship—Outside
- Sheet Metal Work
- Tool Making

NAME.....
HOME ADDRESS.....
CITY.....

OCCUPATION.....
AGE.....
STATE.....

THIS IS YOUR BALLOT

Check the career that interests you most, Fill in spaces and mail at once—no obligation

● *Today*, choose the job you want — and prepare for it in spare time at home. Or if you are already engaged in the work you like best, start training *now* for quicker promotion. In hours you might otherwise waste, gain the knowledge and skill that can help you to get ahead faster, make more money, and have greater security.

Thousands before you have followed this plan and were able to step out ahead of others who didn't fit themselves for advancement or who seemed willing to trust to luck.

Training Backed by 55 Years of Experience

For over half a century American School has helped ambitious men and women

toward success by providing specialized training for commercial and technical advancement. At a cost you can afford *you* can prepare *at home* to climb in the kind of work you prefer. American School's study program for *you* has been planned by experts with years of experience in the subject you select and they will give you needed guidance every step of the way.

Don't Delay Your Start

Give serious thought to the list of training courses listed above. Pick the opportunity that interests you, check it and add your name and address. (Check more than one if you are undecided as to which appeals most.) Finally clip out and mail the "ballot" and full information will be supplied, without cost or obligation.

PRACTICAL, EFFECTIVE HOME STUDY TRAINING SINCE 1897

AMERICAN SCHOOL, Dept. G146, Drexel at 58th, Chicago 37, Ill.

THE SOONER YOU START, THE SOONER YOUR GOAL CAN BE REACHED

Learn this Profitable Profession



IN 90 DAYS AT HOME

Money-Making Career Open to Men and Women, 18 to 60

Hundreds of men and women between 18 and 60 make \$10 to \$20 in a single day giving scientific Swedish Massage and Hydro-Therapy treatments. There is big demand from doctors, hospitals, sanatoriums and clubs. Graduates earn large full time incomes from these or in private practice in their own offices. Others make good money from home treatments given in spare time. Learn this interesting, money-making profession in your own home, through our

home study course. Same instructors as in our nationally known resident school. You can win independence and prepare for future security by qualifying for your Diploma. Course can be completed in 3 to 4 months. Many earn while they learn. Begin your training at once.

NEW 32-PAGE BOOKLET FREE

Fill in the coupon below (please print name and address) and mail it for your FREE copy of 32-page Information Booklet. If you act at once we will include Anatomy Charts and Success Booklet which supply additional information you should have. All will be sent postage paid.



THE COLLEGE OF SWEDISH MASSAGE
Dept. 270A, 41 E. Pearson St., Chicago 11, Illinois

Please send me FREE and postpaid New 32-Page Illustrated Booklet, Anatomy Charts and Success Booklet at once.

Name.....Age.....

Address.....

City.....State.....



Be a Well-Paid Expert

ON ALL ELECTRICAL REPAIRS and MAINTENANCE

Defense Program Means Bigger Pay in Essential Field for Top Electrical Repair Men

Prepare NOW for a good-paying, ESSENTIAL job. Defense plants need expert electrical repair, maintenance men. Get the "know-how" from this Electrical Maintenance and Repair Library.

5 Volumes; 2072 Pages; 1834 Pictures

Starts at beginning, takes you step by step through every phase of connecting, altering, testing, repairing all types of equipment. How to install motors, generators, rewind motors; inspect, repair starters; locate trouble; test induction motors, and MUCH MORE! One entire volume crammed with trouble-shooting charts. Simple diagrams make everything crystal-clear. Gives best on-the-job practices of experts. Will



help to put you in big-pay class and to rate as an ESSENTIAL worker.

Send no money Mail coupon for FREE 10-DAY TRIAL. Note special price, easy payments.



McGraw-Hill Book Co., Dept. PS-1-52
327 West 41st St., New York 18, N. Y.

Send me for FREE 10 days' examination the Electrical Maintenance and Repair Library. If not satisfied I will return books. Otherwise I will send \$3.50, plus postage, then and \$4 a month for 4 months (a saving of \$2 under regular price of \$21.50).

Name.....

Home Address..... PS-1-52

City & State.....

WE PAY POSTAGE if you enclose \$3.50 first payment WITH coupon. Same return privilege for full refund.

TEST YOUR OWN RADIO AND TELEVISION TUBES AT HOME!!!



CONDUCTANCE TUBE TESTER

No Tube Manual or knowledge of tubes necessary—Tests All Tubes—100% accurate for direct shorts, opens, burned out tubes.

ONLY \$498 Buy it—Try it—If not satisfied, return in 5 days—Money cheerfully refunded.

SEND NO MONEY—ORDER C.O.D. plus postage, or send check, cash or money order & we pay postage.

E-Z TESTER CO.
(Dept. PS-1) MACON, GA.

Pat. Pending
ALSO AVAILABLE!
CONDENSER TESTER
CHECKS SHORTS, OPENS, INTERMITTANT AND CAPACITY\$6.98

TREASURE -- \$10,000

New locator detects metals, valuable minerals and buried treasure. Money-back guarantee of superiority.



Also geiger counters. Govt. reward of \$10,000 for uranium discovery. Write for FREE information.



THE GOLDAK COMPANY

1544 W. GLENOAKS BLVD., GLENDALE 1, CALIF.

WALKIE TALKIES ONLY \$4.99 for a Complete Set of 2

POCKET SIZE —ELECTRONIC VOICE POWERED

No tubes, batteries, adjustments, license or permit needed! Guaranteed to work anywhere up to 1/4 mile with extra wire. Swell for room to room—garage to house, etc! Your own private, talk-listen phone. Not war surplus. Brand new. Guaranteed. Two complete units with wire —READY TO USE!



SEND \$1.00 deposit and pay postman \$3.99 plus postage charges or send \$4.99 for postpaid delivery. Limited Supply.

THE MIDWAY COMPANY, Dept. WPS-1, Kearney, Nebraska

Artists MAKE MONEY

Do you like to draw? Send name, address, age and occupation for FREE ART TEST, to find out your ability.

ART INSTRUCTION, Inc.

1142 ART INSTRUCTION BLDG., MINNEAPOLIS 15, MINNESOTA

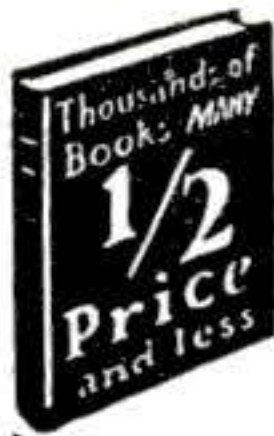

ANY BOOK IN PRINT

Delivered at your door. We pay postage. Standard authors, new books, popular editions, fiction, reference, medical, mechanical, children's books, etc. Guaranteed savings. Send card for Clarkson's 1952 Catalog.

FREE Write for our great illustrated book catalog. A short course in literature. Buying guide of 300,000 book lovers. Free if you write Now—Today!

CLARKSON PUBLISHING COMPANY
Dept. PS-521 1257 S. Wabash Ave., Chicago, Ill.

RUPTURED?

Get Relief This Proven Way

Why try to worry along with trusses that gouge your flesh—press heavily on hips and spine—enlarge opening—fail to hold rupture? You need the Cluthe. No leg-straps or cutting belts. Automatic adjustable pad holds at real opening—follows every body movement with instant increased support in case of strain. Cannot slip whether at work or play. Light. Waterproof. Can be worn in bath. Send for amazing FREE book, "Advice To Ruptured" and details of liberal truthful 60-day trial offer. Also endorsements from grateful users in your neighborhood. Write:

CLUTHE SONS, Dept. 14, Bloomfield, New Jersey.

NOW you can learn TV-RADIO servicing at Home

in your spare time!



BIG DEMAND FOR TRAINED MEN!

Famous CRESCENT SCHOOL of Radio & Television now offers a *complete* HOME STUDY COURSE for those unable to attend classes! CRESCENT SCHOOL's experience of millions of training hours assures you of the finest training available. New simplified lessons and illustrations — *no previous training needed!* Parts-kit included.

Get into this high-paying field with a future! Many students start to earn extra cash while learning. Complete the course as quickly as you can learn. Certificate awarded upon completion of course. CRESCENT SCHOOL's free placement service is available to you!

PAY AS LITTLE AS
\$5 MONTHLY

Total cost for complete course
as little as **\$100**

Crescent School — one of the largest of its kind! Multi-million-dollar plant in its own 6-story building.



INCREASED EARNINGS



INTERESTING WORK



AN UNLIMITED FUTURE

FREE!

Send TODAY for FREE illustrated, interesting booklet & complete details about the Crescent School HOME STUDY COURSE!

SEND COUPON TODAY!

CRESCENT SCHOOL Dept. A-1
500 Pacific St., B'klyn 17, N. Y.

Sirs: Rush free sample booklet & complete details about your HOME STUDY COURSE . . . at no obligation to me.

NAME

ADDRESS

CITY.....ZONE.....STATE.....

To skilled men:

LOCKHEED

in

CALIFORNIA

offers you a

BETTER JOB

in a

BETTER PLACE TO LIVE

Lockheed is building planes for defense, planes for the world's airlines. It's all part of our long-range production program. It means there's not only a better job for you at Lockheed, but a better life. For here in sun-swept San Fernando Valley you find living conditions beyond compare.

Lockheed needs: Machinists Aircraft experience is not necessary. Lockheed will train you.
Tooling Men
Engineers

Lockheed offers you: Top wages, generous travel allowances to be paid after six month's employment at Lockheed, retirement plan and many other benefits only a company like Lockheed can provide.

Middle-age is no barrier to a job at Lockheed. Skill and ability, not years, count here.

To Family Men: Housing conditions are excellent in the Los Angeles area. Approximately 30,000 rental units are available. Huge tracts are under construction for home ownership. Lockheed Employee Service will help you get settled.

Write today for job application blank and illustrated brochure describing life and work at Lockheed in Southern California. Use handy coupon below.

M. V. MATTSON, Employment Manager
LOCKHEED AIRCRAFT CORP., Dept. P 51, Burbank, Calif

My Name _____

My Type of Work _____

My Street Address _____

My City and State _____

Tells How You Can Learn to



FREE BOOK MOUNT BIRDS!

Learn At Home

Men, Boys, Hunters, Fishermen, mount and save your lovely wild-game trophies. Be a Taxidermist. Mount Birds, Animals, Heads, Fish, Tan skins. YOU learn easily, quickly in spare time. Have a grand home-museum. The finest and the greatest hobby known, for sportsmen. Fun, real profits.

FREE BOOK

Yes, FREE. Beautiful strange, valuable Book, telling all about Taxidermy. Contains over 100 beautiful game-pictures. And it's yours FREE, if you rush your request. You can mount all kinds of wild-game, and common specimens too. We can positively TEACH YOU. So GRASP this opportunity. RUSH letter or postal for this amazing FREE BOOK. Don't delay. State your AGE. N. W. SCHOOL OF TAXIDERMY, 2661 Elwood Bldg., Omaha 2, Neb.

GET THIS FREE BOOK!

BECOME AN EXPERT IN TRAFFIC

Traffic men earn \$4,000 to \$10,000 and up. Thousands of firms need experts on rates, tariffs, regulations. We train you thoroly in spare time at home for executive traffic jobs. Personal training under traffic authorities. Placement counsel and help. Write for free 48-page book "Traffic Management—the Fast Growing Profession."

LASALLE Extension University, 417 So. Dearborn St.
A Correspondence Institution, Dept. 183T, Chicago 5, Ill.

Learn CARPENTRY BRICK LAYING

Get into the billion dollar building trades. Learn now while opportunities are greatest. Train in our completely equipped shops under expert instructors. Enroll now. Limited Classes. Write for information about our PAY AFTER GRADUATION PLAN and FREE catalog.

MIDWEST SCHOOL OF BUILDING TRADES, Dept. PS-1
411 N. Center St. Bloomington, Ill.

RETIRE IN 5 YEARS

Have better life. Earn big money. Retire in 5 yrs. Raise playful, profitable Chinchillas. Easy to raise in spare time. Minimum work, overhead. Write today for FREE details on plan which will insure your future.

FISHER'S KEY CHINCHILLA EXCHANGE
Dept. PS-1, 1611 Montana Ave., Santa Monica, Calif.



LEARN FASCINATING

Leathercraft

Make your own bags, belts, wallets, etc. Learn fascinating, profitable leathercraft in spare time. Send 25c for valuable Catalog, has over 200 photographs. (refunded first purchase).

BURTONS LEATHERCRAFT

Dept. PS-1, 1755 1/2 Glendale Boulevard, Los Angeles 26, Calif.

Buy U. S. Defense Bonds

\$2.98 SPATZ FIREARM INVENTION!

Complete with 50 bullets

GUARANTEED Without Crip

Nickel Finish

All Metal

Simplified percussion action permits low cost shooting. Not an air or pellet gun — but a small bore firearm! Light 14 mg powder charge drives .12 caliber lead bullets at high velocity. Gun has only 4 moving parts. 5 inch barrel. Heavy duty. Free pamphlet on expert pistol shooting, indoor-outdoor target ranges. Ammunition at stores. Limited quantity Spatz pistols. Sold direct. Adults only. State age. Send \$2.98 to LUNDE ARMS CORP., Box F 354, San Gabriel, Calif.

NOW! LEARN THE VITAL ELECTRIC EQUIPMENT and APPLIANCE SERVICE and Repair Business!

"I made \$800
in 3 months
while still
taking your
course"-F.V.
NEW YORK



"I made \$14 per
day while still
learning"-T.E.H
WEST VIRGINIA



BIG MONEY—INDEPENDENCE

Here is the ideal business for the man who is happiest when working with tools. Wide open opportunities in every city, town, village. Everyone a customer for the man trained to service and repair electrical equipment and appliances.

NO PREVIOUS EXPERIENCE NEEDED

New visual method of instruction teaches you how to repair electric motors, house wiring, refrigerators, auto ignitions, automatic washers, garbage disposals, fluorescent lights, irons, cleaners, etc. **NO PREVIOUS EXPERIENCE NEEDED.** Almost before you know it you will have the knowledge to help you make **BIG, EASY PROFITS** at home in this highly respected and growing field.

Yours!
Big Kit Tools
Does not cost you
one cent extra.

AGE NO HANDICAP

Young men, older men, even the man of 69, can find a place in this expanding big-money field. Grasp this opportunity for better things today.

PACIFIC TRAINING SCHOOL

Dept PS-521 7217 So. Broadway • Los Angeles 3, Calif

Your Own Business—Spare or Full Time

Your own business—your own shop. Complete step-by-step instructions include our book, "HOW TO OPEN YOUR OWN BUSINESS." Costs nothing extra. PTS training more than a home-study course—gives you the "know-how"—all the professional secrets of electrical equipment and appliance repair and service—the operation of your own shop from a business standpoint—what to charge—how to bring your customers to you—everything to start you on the road to success and future security. I'll send you my complete plan that shows you how to learn the electrical equipment and appliance service business.

SEND NO MONEY—WRITE TODAY!



FREE!

Book that tells you how to learn to repair and service electrical equipment and appliances.

MAIL COUPON NOW

PACIFIC TRAINING SCHOOL, Dept PS-521
7217 S. Broadway, L.A. 3, Calif

Send me your FREE book that tells me what electrical appliance repair and service can mean to me. Remember I am under no obligation.

Name _____

Address _____

City _____ Zone _____ State _____

WRITE 3 WORDS MAKE \$6.00 PROFIT—

—on 10-Second Demonstration to merchants. Write on glass with amazing Magic Crayon—Presto!—5 color advertising message takes fire, glows like brilliant Neon. Three sales daily bring \$18 profit. Rush name for FREE Sales Kit. **MAXILUME CO., 125 W. Hubbard, Dept. L-9-A, Chicago 10, Ill.**

*Write
with
Light—*

WHY DON'T YOU WRITE?

Writing short stories, articles on business, travel, shop crafts, sports, local and club activities, etc., will enable you to earn extra money. In your own home, on your own time, the New York Copy Desk Method teaches you how to write the way newspaper men learn—by writing. Our unique "Writing Aptitude Test" tells whether you possess the fundamental qualities essential to successful writing. You'll enjoy this test. Write for it, without cost or obligation.

NEWSPAPER INSTITUTE OF AMERICA

Suite 5722-A, ONE PARK AVENUE, NEW YORK 16, N. Y.

LEARN MEAT CUTTING AT NATIONAL Pay After Graduation

NOW—train in **JUST 8 WEEKS** at famous National School for a big-pay job with a **SECURE** future in the dependable trade of Meat Cutting, Meat Merchandising and Self Service Meats. Be an expert Meat Cutter, Market Manager, Supervisor and *make an experts pay*. Get a profitable market **OF YOUR OWN**. Unlimited opportunities in this vital, nationwide field.

You learn easily, quickly the National Way. You have your own tools and meat to work with. Expert instructors show you how. You get actual, practical experience right here in our big, modern school where we have been training top meat men for *nearly 30 years*.

Cutting, percentage, pricing, advertising, selling, buying, **A COMPLETE RETAIL MEAT EDUCATION**. Diploma. **FREE** employment help. Thousands of successful graduates.

TRAIN NOW—PAY LATER

Get your training **NOW**. Pay tuition in easy installments *after you graduate*. We'll get you a job, if you need it, to **PAY ALL YOUR EXPENSES** while at school.

If you want to **BE A SUCCESS**—*have a secure future*—send coupon **AT ONCE** for our big 52-page school



catalog showing students in training and telling about our **LEARN BY DOING** method. Read letters from graduates. **GET ALL THE FACTS**. No obligation. You have everything to gain. Paste coupon on postcard or mail in envelope **TODAY**.

National School of Meat Cutting, Inc., Dept. 51-A, Toledo 4, Ohio

Send me your **FREE** school catalog on National Training at Toledo in Meat Cutting, Meat Merchandising and Self Service Meats. No obligation. No salesman will call.

Name _____

Address _____

City _____ Zone _____ State _____

CORTINAPHONE
makes it FUN to



SPEAK FRENCH-SPANISH

**RUSSIAN - GERMAN
ITALIAN - BRAZILIAN - JAPANESE**

"Learn by Listening" to CORTINA RECORDS, at home, the NATURAL way—quickly, easily, cheaply.

Only 15 Minutes a Day!

The Cortina method, famous for 70 years, teaches you to speak like a native. THOUSANDS have found it the most fascinating, most effective way to learn languages for Pleasure, Business, Travel, Culture. INVESTIGATE!

Send For FREE BOOK!

Illustrated 32-page book, "The Cortinaphone Short-Cut" sent FREE. No obligation. Tells just what you want to know. Interesting. Get it!

ALL NEW RECORDINGS ON UNBREAKABLE RECORDS WRITE TODAY

CORTINA ACADEMY (Est. 1882)
Suite 121, 105 W. 40 St., N. Y. 18, N. Y.

Please send me—without obligation—your free book. I am interested in (check)

French Spanish German Italian Brazilian
 Russian Japanese

Name.....

Address.....

City..... State.....

VETS! Check if NOW eligible under G. I. Bill.

LAW FREE BOOK



Your FREE copy of "The Law-Trained Man" shows how to gain prestige and greater earnings through Blackstone home law study. All instruction material furnished including 17-volume Law Library written by 65 well-known law authorities. Lawyers, judges among our graduates. LL.B. degree. Low cost; easy terms. Write today.

BLACKSTONE COLLEGE OF LAW Dept. 121, Chicago 1, ILL.
225 N. Michigan Ave.

A Correspondence Institution Founded in 1890



Don't Send a Cent

Until you see our tires. "REMEMBER" you get only what we advertise. "Not retreads." "Not recapped." Not new treads—that have been recapped. WE SHIP ONLY GOOD USED TIRES. Send for just one tire and see if this trial will make you a satisfied customer.

BUT IF YOU SEND CHECK OR MONEY ORDER IN FULL WITH THIS AD "NOW"—you may take **20%** discount on every tire. SAVE TIME—SAVE MONEY

TUBE GIVEN WITH EACH PASSENGER & TRUCK TIRE

WRITTEN GUARANTEE—Sent with Every Tire You Buy

ONE Quality ONE Price—Why take less? Our Tires used on Cars & Trucks for every purpose—18 YEARS AT THIS ADDRESS.

600x16 \$6.73	670x15 \$7.75	710x15 \$7.8	760x16 \$8.95
650x15 7.24	700x15 7.95	750x16 8.58	820x15 8.65
650x16 7.32	700x16 7.80	760x15 7.95	550x17 6.40

GOOD TREAD—NO RE-CAPS. THESE TIRES WILL CARRY YOU TWICE AS FAR!

600x20 \$12.18	32x6(8) \$15.00	900x20 \$23.00	1000x22 \$22.75
650x20 12.69	32x6(10) 17.50	1000x20 22.75	1100x22 22.95
700x20 15.00	34x7 17.00	1100x20 22.75	1100x24 23.95
750x20 15.71	825x20 23.00	550x18 6.50	700x17 13.00

Thousands of tires shipped all over U.S.A. All tires shipped F.O.B. Phila. Send Check or M.O. with this ad. Dept. 5.

STANDARD 834 N. Broad St., Philadelphia 30, Pa.

FOAM RUBBER

FOR HOBBYISTS, CRAFTSMEN, EXPERIMENTERS



Lowest Prices—SAVE 50%
16 x 16 x 1 1/2" . . . ea. \$1.35
16 x 22 x 1 1/2" . . . ea. 1.75
18 x 24 x 1 1/2" . . . ea. 2.00
24 x 24 x 1 1/2" . . . ea. 2.95

AUTO SEAT TOPPER PADS
Place under seat cover
24" x 60" x 1 1/2" . . . ea. \$6.45
24" x 60" x 2" . . . ea. 7.95
12" x 14" x 1 1/2" . . . ea. 1.25

Use for furniture cushion fillers, mattresses, Mattress pads, cushions. Foam Rubber is available in any size or thickness. Send For Free Price List. Immediate delivery. No C.O.D.'s. Add 10% for Postage & Handling to Above Prices. Please print.

FOAM-KING RUBBER CO., Dept. SP-1
P. O. Box 2676, 1174 W. Monroe St., Jacksonville, Florida

•• A SHOE BUSINESS IN YOUR HAND! ••

EARN \$60 WEEKLY
WITH ONLY
3 SHOE ORDERS A DAY!



THE
BIGGEST
SELLER
IN
30 YEARS

HEEL
TO
TOE
CUSHION

Make more money with famous 30 year old company. Show complete line quality shoes for men, women, children. Commissions to \$4.00 per pair. PLUS Cash Bonus to 75c per pair. PLUS Paid Vacation! Smash hit styles with magic comfort heel-to-toe cushion are selling dynamite. No experience or investment needed. Actual shoe samples supplied without cost. Write TODAY for full information and FREE 60 page Spring Catalog. **TANNERS SHOE CO., 918 Boston 10, Mass.**

CARBURETOR TOO RICH MAKES MOTORIST TOO POOR



Car owners who are wasting money and not getting proper gas mileage due to over-rich mixtures will be pleased to learn how to save gasoline by VACU-MATING over-rich mixtures. VACU-MATIC fits all cars, trucks and tractors. It is automatic and operates on the supercharge principle. Easily installed in a few minutes.

SALESMEN WANTED! Big Profits!

Send name, address on penny postcard for free particulars and how to get yours for introducing.

VACU-MATIC CO., 7617-1834 W. State St., WAUWATOSA, WIS.

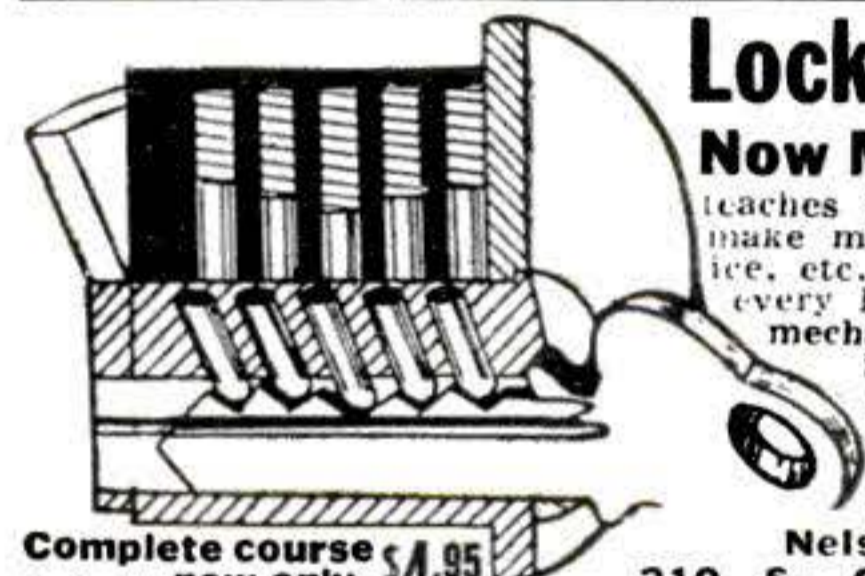

Locksmithing AND KEY MAKING

Now Made Easy! Practical up-to-date course

teaches you how to pick locks, de-code, make master keys, repair, install, service, etc. New self-instruction lessons for every handyman, homeowner, carpenter, mechanic, service station operator, fix-it shop, hardware dealer, gunsmith. 53 easy illustrated lessons. Full price only \$4.95, post-paid; or C.O.D. plus postage. Satisfaction or refund guaranteed.

Complete course \$4.95
now only \$4.95
Nelson-Hall Co., Dept. A-1
210 S. Clinton St., Chicago 6, Ill.

U.S. OIL LEASES PAY OFF

FIND WHAT YOU CAN DO FOR ~ ~ \$200.

Congress has given any U. S. citizen the right to file for oil leases on certain public lands. Some U. S. oil leases have lately paid \$150,000 for under \$200; \$250,000 for \$250; \$137,000 yearly for \$200. We locate you a lease in a possible oil area. Scores of our clients have sold U. S. leases we obtained for them to major oil companies, keeping part of the oil for themselves. In California the estimated oil under 40 acres of OIL LAND is 2 million barrels. That is why you have a chance at enormous returns by risking \$200. Write for free booklet.

CALIFORNIA LEASE CO.
7075 HOLLYWOOD BLVD. LOS ANGELES 28, CALIF.

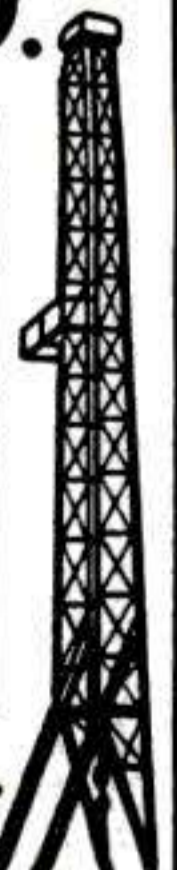

If you can draw, your future is secure

America's 12 Most Famous Artists

now test your art talent!



This exciting test, printed on 8 large pages of 11" x 14" drawing paper, has over 50 illustrations. It tests you seven ways to show your sense of design, composition, form, observation, imagination, originality and picture sense. Yours if you act today.

Thousands paid \$1.00 to take this amazing test. To meet the ever-increasing demand for artists needed for higher-paying jobs, this talent test is now offered **FREE. Quantity limited. Write today!**

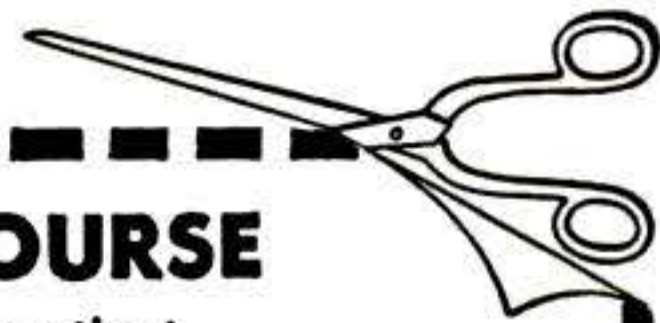

FAMOUS ARTISTS COURSE

Studio 11-A, Westport, Connecticut

Send me with no obligation the Famous Artists Talent Test

Mr. _____ Age _____
 Mrs. _____
 Miss _____ (please print)
 Address _____
 City _____ Zone _____ State _____

There's BIG MONEY in UNIFORMS and Work Clothes that ADVERTISE!

Every business and businessman is swinging over to employee uniforms and work clothes, embroidered with company name, trademark, sales message, etc. The field is new. Prospects are everywhere — garages, service stations, factories, coal dealers, dairies — and hundreds more. Profits are huge. You take orders by the dozen and gross! One man made over \$800.00 on a single deal! You get the business everytime because you offer latest style and finest fabrics. Big selling kit sent FREE!



TOPPS, Dept. 621, Rochester, Indiana

Get into Good Paying AUTO BODY and FENDER WORK



BIG DEMAND in Auto Body and Fender work. Start training now in your spare time at home for good pay work. Practical shop experience included. U. E. I. Training covers metal work, welding, painting, etc. Placement service—or we will show you how to start your own shop. Behind U. E. I. TRAINING is a large national organization founded 1927. Write today for **FREE FACTS**—No obligation.

Write For Free Facts

AUTO-CRAFTS DIVISION • UTILITIES ENGINEERING INSTITUTE
 2523 SHEFFIELD AVE., DEPT. XM-11, CHICAGO 14, ILLINOIS

FAMOUS 15 & 17 JEWEL BULOVA WRIST WATCH \$16.95 PLUS TAX



WERE UP TO \$59.50
 SAVE \$42.55

Also Choice of
 • BENRUS
 • GRUEN
 • WALTHAM
 • or ELGIN
 Watches

You get these unredeemed **LIFETIME GUARANTEED** famous make watches in latest style Yellow Gold Cases at this sensationally low price because we bought out **SURPLUS STOCKS** of leading New York and Md. jewelers. Order now while they last. Specify make preferred and whether men's or ladies! Only \$16.95, plus \$1.70 tax. Order right now!

UNLIMITED WRITTEN GUARANTEE

FREE 10 DAY TRIAL

FREE EXPANSION BAND WITH EACH ORDER

SAVE \$44 ON THIS \$14.95 PLUS TAX 17 JEWEL WRIST WATCH

FORMERLY SOLD FOR \$59.00
INCABLOC SHOCK PROTECTED
WATER & DUST PROOF
 Worn by **ARMY, NAVY & MARINES**

Luminous dial, sweep second hand, Super Accurate. Imported Swiss precision movement and case. You get these brand new **LIFETIME GUARANTEED** watches now for a small fraction of the original price. You save \$44, because we bought out surplus stocks. Order men's style \$14.95 plus \$1.50 tax or ladies' and nurses' style. \$16.95, plus \$1.70 tax. Order now at this low price.



NURSES' MODEL \$16.95 Plus tax

WEAR AT OUR RISK!
 Money Back guarantee in 10 days if not delighted.

SEND ONLY \$1 DOWN PAYMENT with order. Pay balance to postman on arrival plus postage. Or we pay postage if you enclose full payment plus tax.

MARYLAND DISTRIBUTORS, DEPT. 340
 501 E. BALTIMORE ST. BALTIMORE 2, MARYLAND

FREE!
 Watch and Jewelry Catalog at almost Wholesale Prices.

The **NEW Model 50 UTILITY TESTER**
FOR REPAIRING ALL ELECTRICAL APPLIANCES-MOTORS
an all-around electrical trouble shooter



- Measures A.C. and D.C. Voltages, A.C. and D.C. Current, Resistances, etc.
- Will measure the current consumption while the appliance under test is in operation. The appliance or utility may be plugged directly into the front panel receptacle. A special pair of insulated clip-end leads is included for motors, etc.
- Incorporates a sensitive direct-reading resistance range which will accurately measure all resistances commonly used in electrical appliances, motors, etc. This range will enable continuity checks and tests for shorts and opens.
- Will test thermostats, radio tube filaments, bulbs, fuses, fluorescents, condensers, switches, field coils, circuit breakers, lighting systems, etc.

Handsome round cornered molded bakelite case 3 1/8" x 5 7/8" x 2 1/4". Complete with all test leads and instructions.

\$13.90

SOLD ON EASY PAYMENTS AT THE NET CASH PRICE

No interest or carrying charges added. Simply remit \$3.90 with order, pay balance, \$2.00 per month for 5 months.

SUPERIOR ELECTRONIC CO., INC.
 Dept. B-48 • 227 FULTON STREET • NEW YORK 7, N.

FIRST AID FOR TV SET OWNERS!

H. G. CISIN'S "TV DOCTOR"

Shows you how to fix your own set rapidly and SAFELY!



YOURS TO TRY 5-DAYS FREE!
 Save money, throw away service contracts! Here's a real "fix-it-yourself" book—an amazing, quick, copyrighted method of locating & fixing TV troubles. Written by a noted inventor & educator, H. G. Cisin, in language you can understand.

TUBES CAUSE 80% OF TV TROUBLES!
 "TV DOCTOR" shows you how to quickly locate and change all defective tubes with complete safety.

WITHOUT EXPERIENCE!—PICTURES & TEXT MAKE FIXING IT YOURSELF EASY
 Reveals many closely guarded TRADE SECRETS. Lists over 123 trouble conditions. Method applies to all TV sets, even newest RCA's, Philco's or any 2,000 models, old and new. Copyrighted TROUBLE SHOOTING GUIDE pin-points hundreds of troubles.

11 money-saving, fact crammed, detailed, illustrated chapters include: practical ways to combat interference & ghosts, how to appraise & buy a TV set, valuable information on antennas, lead-ins, color, explains TV terms, lists names & addresses of TV mfgs.—a veritable encyclopedia.

Save Expensive Service Calls!
Be assured of Continual TV Pleasures!
Only \$1.—you'll say it's worth hundreds.

SPECIAL OFFER: A new "TV DICTIONARY & PICTURE GUIDE" with illustrations explaining TV terms and selling for \$1; H. G. Cisin's famous "TV TROUBLE SHOOTING METHOD," which trains you to be a TV diagnostician & TV serviceman . . . sells for \$1. **PLUS** the "TV DOCTOR"—all 3 for only \$2, postpaid . . . you save \$1.

RUSH COUPON with your name & address. Enclose \$1; 5-days to read without risk or return for refund.

H. G. CISIN, Consulting Engineer,
 (Dept. PS-6), 200 Clinton St.,
 Brooklyn 2, N. Y.

Enclosed find \$2, full payment for "TV DOCTOR," "TV TROUBLE SHOOTING METHOD," & "TV DICTIONARY," rush copies postpaid.
 Enclosed find \$1, in full payment for "TV DOCTOR," rush copy postpaid.

Name
 Address
 City Zone State



WAR SURPLUS BARGAINS

\$500,000.00 INVENTORY for QUICK LIQUIDATION

Surplus items—hundreds of them for home, shop, factory, farm and outdoor use. New items, used items, reconditioned items—all at tremendous savings—all priced for quick sale.

PAGE AFTER PAGE OF VALUES

This big catalog shows page after page of amazing money saving values. Write for your copy today. Send 10c to cover postage, mailing, etc. Write today!

10c

SEND TODAY FOR YOUR COPY STARK'S

509 So. State St.
 Dept. PS-A
 CHICAGO 5, ILL.



LEARN TO DANCE \$1.00

Why be a lonely, unpopular wall-flower? Learn all the smart dances from the most modern to the old favorites—at home, in private without teacher, music or partner. So simple even a child can learn quickly. Tap dancing, Waltz, Collegiate, Samba, Rhumba, Jitterbug and many others, including illustrations. Complete course only \$1.00. Also, delightful old square dances with illustrations for \$1.00. Get each Separate or both for \$1.98. If you order both take your choice of FREE-DREAM BOOK or LOVE LETTERS. C.O.D. orders 25c extra and Postage.

Superior professional taps, both toes and heels \$2.98 prepaid or C.O.D. plus shipping charges. State size, large or small.

ROLLDEX, P. O. Box 45, Dept. D-85, Huntington Sta., N. Y.



Play GUITAR in 7 DAYS

OR GET YOUR MONEY BACK!

Let Ed Sale teach you to play with his famous diagram photo system. Book contains 53 photos, 43 diagrams, showing exactly how to place your fingers. Gives you 110 popular songs, words and music—along with complete, easy to learn instructions. Imagine your joy when you find after 7 days you are playing beautiful music! Amaze your friends! Be the life of the party! **SEND NO MONEY.** Pay Postman \$1.98 Plus Postage. **ED SALE, Dept. PS-1, Point Pleasant, N. J.**

LEARN AIR-CONDITIONING REPAIR and SERVICE BUSINESS
...FREE BOOKLET SHOWS YOU HOW!!

Practical "quick results" method enables you to earn and learn in spare time at home. **BIG PROFITS—BIG DEMAND** for qualified men—or start your own business. No previous experience needed. Special tools and equipment furnished. Write for free book that tells you how to learn air-conditioning repair and service. **ACT NOW! MECHANICS TRAINING SCHOOL, Dept. PS-521, 7217 S. Broadway, Los Angeles 3, California.**



Buy U. S. Defense Bonds

Wake Up To More Comfort

Without Nagging Backache

Nagging backache, loss of pep and energy, headaches and dizziness may be due to slowdown of kidney function. Doctors say good kidney function is very important to good health. When some everyday condition, such as stress and strain, causes this important function to slow down, many folks suffer nagging backache—feel miserable. Minor bladder irritations due to cold or wrong diet may cause getting up nights or frequent passages.

Don't neglect your kidneys if these conditions bother you. Try Doan's Pills—a mild diuretic. Used successfully by millions for over 50 years. It's amazing how many times Doan's give happy relief from these discomforts—help the 15 miles of kidney tubes and filters flush out waste. Get Doan's Pills today!



I'll show you how to **EARN** **BIG MONEY** **IN PLASTICS** without tools or machinery!

A NEW HOME INDUSTRY

NEVER BEFORE has such a **GREAT OPPORTUNITY** like this been offered! The **CHANCE OF A LIFETIME!** The chance to learn and **START** a new, fascinating and **HIGHLY PROFITABLE** business of your own! We have started **THOUSANDS** of ambitious people in this wonderful and thrilling new business because the work is so easy and pleasant (many turn it into a profitable hobby), requires only a **FEW** dollars investment, can be started **ANYWHERE** by **ANYONE** . . . at home, garage, basement, den, shop, etc., and most important, **WITHOUT TOOLS OR MACHINERY** you can produce in **QUANTITY** exceptionally attractive and desirable plastic things of such great variety and usefulness beyond your imagination! All this valuable knowledge and instruction is yours **FREE** . . . we teach you, help you get started and **buy part of your production!** We also help you obtain **DEFENSE WORK!**

MAKE ANYTHING

This new method of creating unlimited quantities of useful things without machinery is **CASTING** . . . the extremely simple process of pouring liquid plastics into molds; the entire method is as easy as pouring water out of a glass. No machinery or tools required! In a few minutes the liquid turns into a beautiful solid, hard, durable, colorful or transparent plastic in the form of Jewelry, Novelties, Gadgets of every shape and form, Machine Parts, Fishing Lures, Bookends, Cig. Lighters, Tools, Dies, Handles, Knobs, Pensets, Figurines, Souvenirs, Toys, Dolls, Baby Shoes . . . **A THOUSAND USEFUL THINGS!** Some of our plastics are transparent and sparkling clear, ideal for imbedding flowers, photos, curios, etc. Others are like beautiful Ivory,

PLASTICAST CO. (Dept. A)

P. O. Box 6737
Chicago 80, Ill.

(Write to
nearest address)

P. O. Box 987
Palo Alto, Calif.

CANADIAN CUSTOMERS: Send 35c for catalog to Canadian Ind. Plastics, 1056 1/2 W. Pender St., Vancouver, B. C.

Ebony, Marble, Ceramics, Etc. The field is really **UNLIMITED**. Practically anything your imagination can create can be **CAST** with our plastics, one or a thousand!

BILLIONS FOR DEFENSE

The government has started the greatest defense program in history! **BILLIONS** are being spent! Our liquid plastics can be used in **THOUSANDS** of vital defense applications. With our catalog we will include instructions how **YOU** can obtain defense work, how **YOU** can take part in this tremendous program to insure the future of America! A grand opportunity to combine patriotism and profit! A grand opportunity of obtaining **THOUSANDS OF DOLLARS** of defense work!

1000 OPPORTUNITIES

Regardless what you are doing now you can get into the **CASTING BUSINESS** in your spare time or evenings; we assure you, once you do, you will be eagerly devoting all of your time to this very easy, fascinating and **HIGHLY PROFITABLE** business. Countless letters from enthusiastic busy **PLASTICAST** users testify to successful businesses developed as a result of answering this ad! **BUT LET US PROVE IT:** send only 25c for our big 48 page catalog of Casting Materials, Molds, etc. We will also send you, absolutely **FREE**, an attractive **CASTING** to show you what can be done with our plastics in a few minutes! **IN ADDITION**, we will also send you a valuable instruction book giving details on the **ART & BUSINESS OF CASTING!** Yes, all this for only 25c, but write for it today . . . *this may be the lucky coin that will start the most fascinating and profitable phase of your life!* Don't delay anything that can mean so much to your future—write today.



FREE



Beauty in 3rd Dimension



A selection of figure studies in breathtaking 3rd Dimension. These pictures come to life when viewed through the magic viewer. Realistic depth and beauty only 3rd Dimension can provide.

Send 25c for Magic Viewer & Samples

FREE LISTS

STAND-OUT 141-E N. La Brea Ave.,
Los Angeles 36, Calif

ENGINEERING DEGREE IN 27 MONTHS

Big Demand for Graduates

AERONAUTICAL, CHEMICAL, CIVIL, ELECTRICAL, MECHANICAL and RADIO ENGINEERING (including Television).

Hundreds of young men are earning engineering degrees in this recognized institution each year—continuous operation. New terms start quarterly. Many students earn a major part of their college expenses in this large industrial center.

Low tuition. Competent instruction. Thorough, intense, practical program. Modern laboratory facilities including new physics lab. and modernized wind tunnel. Individualized instruction emphasized.

Approved for Veterans. Engineering preparatory courses. Students from 48 states and 21 foreign countries. Enter March, June, September, December. Send coupon for free catalog and full information. Enroll now.

SEND COUPON TODAY

INDIANA TECHNICAL COLLEGE

612 E. Washington Boulevard
Fort Wayne 2, Indiana

Please send me free information on B. S. Engineering degree in 27 months as checked.

- Aeronautical, Chemical, Civil,
 Electrical, Mechanical, Radio-Television.

Name.....

Address.....

FREE



NEW BIG RADIO CATALOG

Ready now! Complete with everything in radio, TV and electronics. Newest parts as well as old, standard lines. Paste coupon on penny postcard and mail today!

Lafayette Radio

DIV.: RADIO WIRE TELEVISION, INC.

NEW YORK 13.....100 Sixth Avenue
NEWARK 2.....24 Central Avenue
BOSTON 10.....110 Federal Street
BRONX 58.....542 E. Fordham Road

30 YEARS OF VALUES

LAFAYETTE RADIO, Dept. KI-1
100 Sixth Avenue, New York 13
Please rush Free catalog to:

Name.....
Address.....
City.....State.....

PASTE ON PENNY POSTCARD

WALTHER

9MM AUTO.

P-38

\$37.50

Very Good



Official World War II German Automatic. "Small Arms of the World" states "Only Military Pistol fitted with double lock hammer. Appears likely in time to replace the '08 Luger pistol. Excellent grip, balance, hang, etc." Barrel length 4 3/4"; overall 8 1/2"; weight 34 oz. 8 cartridge magazine. Proof tested. Ammunition available everywhere. SAME MODEL EXCELLENT CONDITION \$47.50.

UNCONDITIONALLY GUARANTEED

If not satisfied return within 5 days for full refund. Immediate delivery. In ordering you must state that you are not a minor, alien, fugitive from justice under indictment or been convicted of a crime of violence. No C.O.D.'s. Prices F.O.B. Chicago. NONE SOLD TO MINORS.

UNITED ARMS CO., 9043 S. Western, Dept. FA-855, Chicago 20

PARTS FOR MILITARY TRUCKS

At A Savings. New FREE Catalog
For Jeep, Dodge, Chevrolet, G.M.C., Studebaker

Brand New—Not War Surplus—Complete
JEEP TOPS and SIDE CURTAINS

Fits all Military Jeeps. Also adaptable to some Civilian Jeeps. Waterproof O.D. \$59.50

AXLES FOR TRAILERS

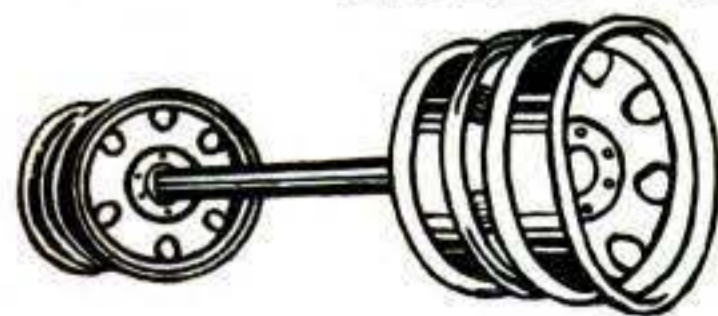

(Surplus) Heavy Duty axles suitable for building of many types of trailers, farm wagons, etc. Standard width straight axle, 2 inch square and is complete with Hubs, Timken bearings, 6 Hole 750x20 or 825x20 wheels, with- out brakes, only \$69.50

Dual Wheels . . . add \$15.00 extra

Hundreds of Other Truck & Jeep Parts and Supplies

All prices quoted good 30 days FOB, Kansas City
25% deposit required on COD orders.



UNITED AUTO PARTS CO. INC
1901 TROOST GR. 1800 KANSAS CITY, MO.

AMAZING WORK SHIRT BARGAIN

FREE 10-DAY TRIAL

What a Bargain! Sturdy, serviceable shirts, though used, have been washed, sterilized and reconditioned. Made of long-wearing wash materials. Blue, tan, white. Strongly sewn; reinforced at points of strain. Money back guarantee!

WORK PANTS TO MATCH... 99c
Blue, Tan, White. Measure waist: leg.

SEND NO MONEY! Give name, address, size and color choice, (also state 2nd color choice) Pay postman plus postage. Or, send Cash, Check, or Money Order and we ship prepaid. Keep 10 days. Return for full refund of purchase price if not satisfied. Order TODAY at Our Risk!



79¢
3 for 2.29

YOUNG PRODUCTS

Department 109

2605 ELMHURST • DETROIT 6, MICH.

BATTERIES START A FACTORY AT HOME



—and re-cast junk batteries into new, with and without new materials; the latest achievement. We supply complete instructions and everything needed. Large daily profits.

BATTERY LABORATORY SCHOOL
DEPT. PSM, MINNEAPOLIS 4, MINNESOTA

• CONSTRUCTION OF ROBOTS

• COMPUTING MACHINERY

and many other Scientific Subjects

Courses or guided study by mail—beginning or advanced—individuals or study groups. Fitted to your interests and needs—your own questions answered. Cost—\$9. to \$35. For complete information, write:

EDMUND C. BERKELEY & ASSOC.

INVENTORS OF THE ELECTRIC ROBOTS:

"Simon"—Midget Brain • "Squee"—Robot Squirrel

36 West 11th St. P1 New York 11, N. Y.

LEATHERCRAFT

TEXTILE PAINTING
COPPER TOOLING

PAY-OFF



Yes, these crafts "pay off" in pleasure and profit. You can do it! Everything you need in Kit Kraft's big illustrated catalog.

Send 10c (credited to first order) for catalog today!

KIT KRAFT 7377 Melrose Ave., Dept. 37
Hollywood 46, California

make your own Gems 29.50 F.O.B.

All necessary lapidary equipment is furnished, including a super-charged diamond blade for sawing, and all wheels for grinding, shaping and polishing; also complete instructions. The complete equipment as shown, less motor and belt, for only \$29.50, f.o.b., Burlington, Wisconsin. Write today for information and literature.

B&I MANUFACTURING CO.
Dept. M Burlington, Wis.

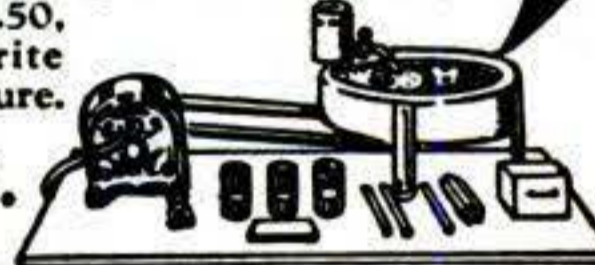

MAIL ORDERS • FREE DELIVERY UNCONDITIONAL MONEY BACK GUARANTEE

Send for FREE WAR SURPLUS CATALOG

Feather SLEEPING BAG

DeLuxe Quality in Every Respect. Save about 1/2!

NEW! 2 AIR MATTRESS POCKETS. Fine grade, water repellant, weather proof khaki cover. Filled with soft, fluffy feathers for warmth, comfort. 2 Bags zip together to make Double Sleeping Bag. Head Flaps for wet weather. Heavy duty all-around zipper for easy airing. Lining. Tubular quilting prevents shifting and lumping of the feathers. Rolls into easy-to-carry pack. \$25 VALUE



Polar Type.
Large size
34 in. x 78 in.

\$13.88
FREE DELIVERY

New! Kapok Filled SLEEPING BAG — \$18.95 Value
Full size 34 x 78. 100% water repellant, plenty of Kapok filling, zipper opening. A top quality sleeping bag at a budget price. Money-Back Guarantee. \$11.79
FREE DELIVERY

UNIVERSAL ENTERPRISES — 946 S. MAIN, LOS ANGELES 15, CALIF.



new book on how to TAILOR your own SLACKS

Here in one gigantic volume is everything you have to know to do a complete tailoring job. Imagine the thrill of wearing the slacks you make. Think of the money you'll save. Send for FREE information today!

- Over 300 informative pages
- Over 150 simple-to-follow diagrams and illustrations
- Easy-to-read directions
- Tested methods approved by leading designers and educators

SEND FOR FREE BOOKLET TO DEPARTMENT "P" Penny post card will do

Guildcraft
36 HALSEY ST. • NEWARK, N. J.

REAL ESTATE
BE A BROKER

PAYS BIG! SEND FOR FREE, BIG, ILLUSTRATED CATALOG NOW! No obligation. Graduates report making substantial incomes. Start and run your own business quickly. Men, women of all ages, learn easily. Course covers Sales, Property Management, Appraising, Loans, Mortgages, and related subjects. **STUDY AT HOME** or in our classrooms in big cities. Diploma awarded. Nationally known. G. I. Approved.

WEAVER SCHOOL OF REAL ESTATE (Est. 1936)
Suite 300 Law Bldg., Dept. PS, Kansas City, Mo.

FREE BOOK TELLS HOW

HOW TO BREAK and TRAIN HORSES

SEND FOR THIS FREE!

Make money. Know how to break and train horses. Write today for this book FREE, together with special offer of a course in Animal Breeding. If you are interested in Gaiting and Riding the saddle horse, check here () Do it today—now.

BEERY SCHOOL OF HORSEMANSHIP
Dept. 581 Pleasant Hill, Ohio

ILLUSTRATED COMIC BOOKLETS

THE KIND MEN LIKE! THE GIRLS LIKE IT TOO!! (VEST POCKET SIZE)

They are loaded with rare cartoons. Full of Fun and Humor. **20 DIFFERENT** booklets sent for \$1 in plain wrapper. No C.O.D.

BULCO, Dept. 154, Box 382-K., G.P.O., N.Y.C. 1

COLD got you? MAKE A FRIEND OF

Take TABCIN to check cold misery quick! TABCIN checks sneezes and sniffles, helps relieve headache and feverish feeling. Eases aches and pains. TABCIN contains a tested anti-histamine in compound with other ingredients to give more complete relief for cold distress.

45c and 75c

Tabcin

ALL DRUG STORES in the **BRIGHT RED** package



"Put Your Finger" ON Any Car Trouble IN A JIFFY!

Handy New Guide Lists 1760 Causes of Faulty Operation, Noises, Breakdowns

SAVE TIME AND WORK on any auto repair job by being able to "put your finger" on exactly what's causing the trouble—right from the start! New, indexed **TROUBLE-SHOOTER GUIDE**—prepared by the Editors of the world-famous **MOTOR'S** Repair Manuals—lists 1760 specific causes of car and truck troubles; helps you find the one you're after **FAST**. Book fits right in your pocket for instant reference. Spiral binding lets book stay open while you work. Cross-section **PICTURES** also included.

If car has Fan Belt noise—turn to Fan Belt Section for 8 specific things that can be wrong. **MOTOR'S TROUBLE-SHOOTER** helps you track down noises, knocks, misses, breakdowns—faulty operation from radiator to rear end. Covers engines, clutches, brakes, ignition, new automatic transmissions, etc. Gives quick help to beginners as well as experienced repair men!

Try Book for 7 Days without obligation!

SEND NO MONEY—Mail Coupon—When postman delivers book, pay him \$1, plus few cents postage and C.O.D. charges. (Or send \$1 with coupon, and we pay shipping charges.) If not delighted, return book in 7 days for full refund. **MOTOR Book Dept., Desk BB, 250 W. 55th St., New York 19, N. Y.**

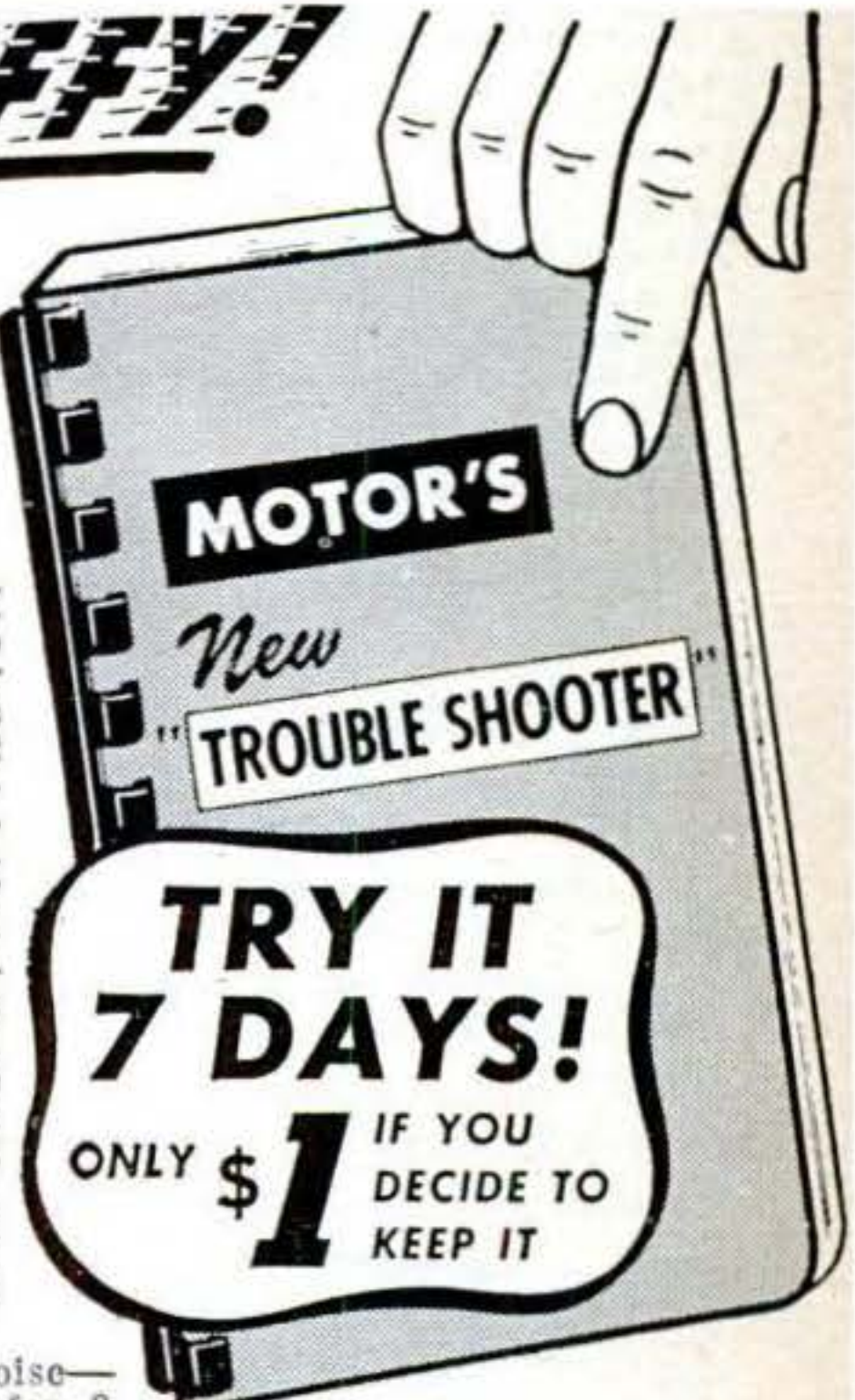

HOW TO SPOT—

87 Automatic Transmission Troubles. 8 Causes of Connecting Rod Noise. 87 Checks for Poor High-Speed Performance. Lack of Power. 82 Causes for Engine "Misses." 17 Checks for Pre-Ignition or Spark Knock. 45 Causes of Excessive Oil Consumption. 14 causes of Crankshaft Noise. 73 Checks for Clutch Troubles. 66 Causes of Rear-Axle Trouble. 150 Checks for Front Suspension and Steering Troubles. 81 Causes of Brake Trouble. 27 Checks for Faulty Springs and Shock Absorbers. 84 Different Types of Wheel Troubles. **AND MUCH, MUCH MORE!**

- New "Dope" On Automatic Transmissions Covers:
- HYDRAMATIC
 - BUICK DYNAFLOW
 - CHEVROLET POWERGLIDE
 - PACKARD ULTRAMATIC
 - STUDEBAKER AUTOMATIC

MOTOR Book Dept., Desk BB, 250 West 55th St., New York 19, N. Y.

Rush me **MOTOR'S** work-saving **TROUBLE-SHOOTER**. I will pay postman \$1 on delivery, plus few cents postage and C.O.D. charges for each copy ordered. Unless completely satisfied, I may return book in 7 days and my money will be promptly refunded.

Name.....
Address.....
City.....Zone.....State.....

SAVE POSTAGE, C.O.D. CHARGES. Check if you send \$1 with coupon, then we pay shipping costs. Same refund guarantee.

Get into BUSINESS for Yourself!



METALIZING BABY SHOES AT HOME IN SPARE TIME

Get facts about amazing money-making Warner Success Plan that shows you every easy step in a completely charted path to personal independence—with your home as your headquarters... This proved and tested Plan is working like magic. It's backed by an old, reliable company... And we send it to you on a No-Risk Trial Money Back Guarantee.

QUICK CASH WAITING

Demand for METALIZED Baby Shoes and other keepsakes is growing bigger daily. Our Tested Plan Shows How to Do the Work, How to Bring in the Business, How to Make as much as \$5 an Hour. Spare or full time, big steady profits are waiting for you. Send penny postcard or mail coupon for FREE Facts. Act! Time is precious.

FREE
offer of
COMPLETE
MONEY
MAKING
PLAN
•
SEND NO
MONEY
Just Mail
COUPON

Ray Brandell, Mgr., Warner Electric Co.,
1512 JARVIS AVE., DEPT. M-2-A, CHICAGO 26, ILL.

Please rush complete details about your No-Risk Trial Money Back Plan for Metalizing Baby Shoes. Everything you send is FREE and costs me nothing—now or ever.

NAME _____
ADDRESS _____
CITY _____ ZONE _____ STATE _____

TRI-STATE COLLEGE

B. S. DEGREE IN 27 MONTHS
Founded 1884
World-Wide Enrollment

Mech., Civil, Elect., Chem., Aero, Radio and Telev. Engineering; Bus. Adm., Acct. Visit Campus, see well equipped buildings and labs. Low cost. Prep. courses. Personalized instruction. Big demand for graduates. Serious shortage of engineers indicated for immediate future. Prepare now Enter Jan., March, June, Sept. Write for Catalog. 512 College Ave., Angola, Ind.



THE MOST AMAZING OFFER IN USED TIRE HISTORY. EVERY PASSENGER TIRE UNCONDITIONALLY GUARANTEED plus TIRE INSURANCE FREE

Here's DOUBLE proof that we bear the loss if your passenger tire wears out within the guarantee period or is damaged in any way (except willfully). Don't take risks: we send FREE insurance certificate PLUS written unconditional guarantee with your order.

10% OFF ON TWO OR MORE TIRES

TRIPLE INSPECTED PASSENGER TIRES UNCONDITIONAL ONE YEAR GUARANTEE plus TIRE INSURANCE FREE					
600-16	\$5.59	700-16	\$7.59	700-15	\$5.59
600-16(6)	6.50	600-15	5.59	750-16	12.25
650-16	5.79	650-15	5.59	550-15	5.59

LO-PRESSURE TIRES FOR EASY RIDING UNCONDITIONAL ONE YEAR GUARANTEE plus TIRE INSURANCE FREE					
640-15	\$5.75	710-15	\$6.50	820-15	\$7.50
670-15	5.95	760-15	6.75	670-16	6.95

MUD AND SNOW TIRES 2 YEAR WRITTEN GUARANTEE					
600-16	\$6.95	900-16	\$12.95	750-20 Reg.	\$12.50
Spec. \$15.95					

EXTRA VALUE TRUCK TIRES ONE YEAR WRITTEN GUARANTEE					
600-20	\$10.75	750-20	\$14.50	825-20	\$21.50
650-20	11.75	32x6(8)	11.75	900-20	19.50
700-20	12.50	32x6(10)	12.50	1000-20	20.00

TRACTOR TIRES available in all sizes. Complete line of High Mileage Tires in stock. Write for price list for sizes not listed. Take off 10% on orders for two or more tires. Prices subject to change. MAIL ORDERS PROMPTLY FILLED. Send check or money order with this ad.

THE SAFTYRE CO.

"FOR THAT SAFE TIRE"

Dept. PS, 920 W. CARY ST., PO Box 2254, RICHMOND, VA.

50 POPULAR SCIENCE

WAR SURPLUS OPTICAL BARGAINS

35 POWER ERECTING MICROSCOPE

Amazing clarity. "All-Position" Universal mount. 3" of working space from objective to platform. Prism Erectors give you an erect image—exactly as your eye sees it. Ramsden Eyepiece permits fine precision focusing. 3-Element color corrected objective—1" diameter. Microscope body is of brass with black crackle finish. 6 1/2" long with base 7"x9". Easily worth \$75.00.



A TRULY FINE OPTICAL INSTRUMENT Worth \$75.00 But Our Price ONLY \$29.50 COMPLETE

Stock No. 970-N... \$29.50 Postpaid

SLIDE PROJECTOR SETS. Consists of all unmounted lenses you need to make the following size projectors:

Stock # 4029-N—35 mm... \$2.85 Postpaid
Stock # 4038-N—2 1/4"x2 1/4" ... \$3.35 Postpaid
Stock # 4039-N—2 1/2"x3 1/2" ... \$3.35 Postpaid

SIMPLE LENS KITS—Include plainly written, illustrated booklet showing how you can build lots of optical items. Use these lenses in photography and for dozens of other uses in experimental optics, building TELESCOPES, low power Microscopes, etc.

Stock # 2-N—10 lenses... \$ 1.00 Postpaid
Stock # 5-N—45 lenses... 5.00 Postpaid
Stock # 10-N—80 lenses... 10.00 Postpaid

We Have Literally Millions of War Surplus Lenses and Prisms for Sale at Bargain Prices. Numerous Types of Lenses, Too! Write for FREE CATALOG-N.

LJ MUND SCIENTIFIC CORP., BARRINGTON, N. J.

ENORMOUS PROFITS CASTING AT HOME

Write today for NEW FREE CATALOG Learn to cast thousands of perfect figurines, plaques, book ends, ash trays, etc. Start NOW—NO EXPERIENCE. LITTLE CAPITAL needed. Earn GREAT PROFITS with X.L. RUBBER MOLDS. X.L. Rubber. Pts. \$2.50. Qts. \$4.00 (postage extra): Models and enough rubber for 3 molds... \$1.50 postpaid.



FREE FACTS SENT

PLASTIC ARTS STUDIO 3403 S. Madison St. Dept. 3 MUNCIE, IND.

Be a DETECTIVE

A CHALLENGE FROM WASHINGTON, D. C. Help Stop Crime! Train at home. Earn big money. Amazing training course from the NATION'S CAPITOL (center of law enforcement) by former U. S. GOVT. AGENT and NAVAL INTELLIGENCE Officer exposes actual methods used by Criminals. Write for FREE BOOK. State age.



INTERNATIONAL DETECTIVE TRAINING SCHOOL
1701 Monroe St., N.E. Dept. 331 Washington 18, D. C.



ILLUSTRATED CARTOON BOOKLETS!

BSAY, FELLOWS! BE THE LIFE OF THE PARTY WITH THESE SMALL ILLUSTRATED CARTOON BOOKLETS OF COMIC CHARACTERS \$10, ALL DIFFERENT, \$1 POSTPAID \$50, NO POSTAL C.O.D.'S! REGINALD SALES 210 L Fifth Ave., New York, N. Y.

ITALIAN ACCORDIONS



All types, all models, Very best. Hand Made. Fully guaranteed. Buy direct from Factory representative at lowest wholesale prices. and Save Money. Also Button Accordions. Chromatic Accordions and Concertinas. We take any instruments in trade. Send name and Address for FREE catalog.

ITALIAN ACCORDION MFG. CO.

7600 Cottage Grove Ave., Dept. PS-1, Chicago 19

COLON TROUBLES

FREE BOOK Tells Facts

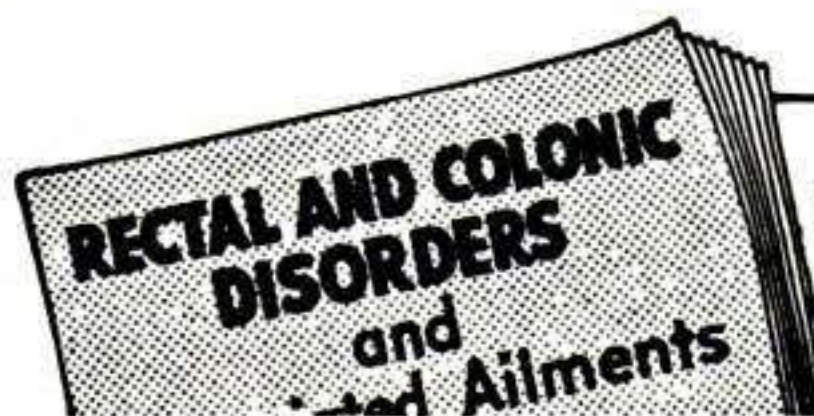

Avoid Dangers of Delay

Learn about Colon troubles, Stomach conditions, Piles and other Rectal ailments. Causes, effects and treatment are explained in a 171-page book, sent FREE. McCleary Clinic and Hospital, 171 Elms Blvd., Excelsior Springs, Mo.



"TOOK IN \$217 FIRST TEN DAYS"

Some Make More, Some Less...

We help you start Your Own All-Year Business

Make Big Money! With our easily operated, highly efficient wall washer, Chas. Stelle took in \$217 gross in first ten days. E. L. Goss took in more than \$10,000 in one year. E. C. Taber wrote, "I made \$400 gross in two weeks." And no wonder—this machine washes walls 6 times faster and better than by hand.

YOUR MONEY-MAKING OPPORTUNITY

We want more men to go into this profitable business for themselves and enjoy independence. There are customers everywhere—homes, offices, schools, churches, hotels, stores, etc. What you take in is mostly profit, for material costs are low. And there's no need to rent a shop or office. Operate your business from your home.

Lose no time. Get all facts without obligation.

WRITE FOR FREE INFORMATION.

Ask for WALL WASHER Details at once.

VON SCHRADER MFG. CO. 1131 "W" PL. RACINE, WIS.

.....

➔ **VON SCHRADER MFG. CO.**
1131 "W" Pl., Racine, Wisconsin

Send at once (no obligation) your **FREE** booklet containing information about your **WALL WASHING MACHINE** and how I can start *my own* permanent, profitable business.

Name _____

Address _____

City _____ Zone _____ State _____

.....



DON'T PAY YOUR INCOME TAX UNTIL YOU READ THIS FREE BOOKLET!

Your income tax return must be filed by March 15th! There are hundreds of legal ways you can save money on your income tax. Find out NOW what they are! We have prepared a **FREE** booklet that gives you tax-saving hints... shows you how to make the maximum savings.

HERE'S PROOF YOU CAN SAVE MONEY!

The Bureau of Internal Revenue recently reported that in one year the tax overpayments to the government amounted to \$100,000,000.00

WRITE TODAY...NOW... FOR FREE BOOKLET

STOP OVERPAYING!

In one year 14,000,000 income tax returns contained errors. Most incorrect tax returns are from people earning under \$7,000 a year.

FREE!

See how to fill out your income tax return so that you can cut your tax to the bone. Get these tax-saving hints today. **THERE'S ABSOLUTELY NO OBLIGATION.**

FRANK J. DELANEY & ASSOCIATES
7269 RISING SUN AVE. • PHILADELPHIA 11, PA.

1952 GOVERNMENT JOBS!

\$3,450.00 A YEAR OR HIGHER TO START RAILWAY POSTAL CLERKS
Veterans Get Special Preference

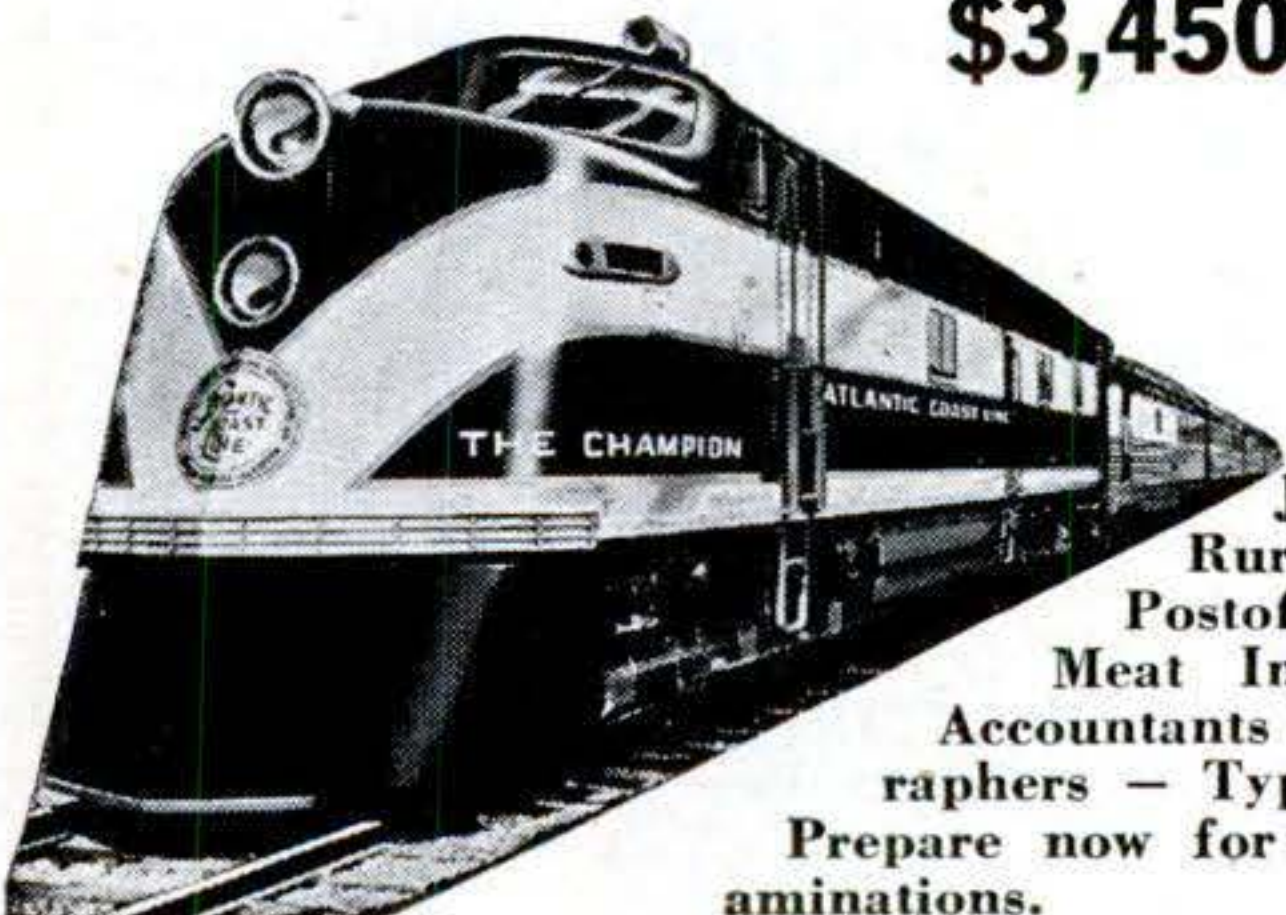

Many other Government Jobs. City and Rural Carriers—Postoffice Clerks—Meat Inspectors—Accountants—Stenographers—Typists—etc. Prepare now for 1952 Examinations.

FRANKLIN INSTITUTE,
Dept. D-80, Rochester 4, N. Y.

(Not Government Controlled.)

Sirs: Rush to me, without charge, copy of 32-page book, "How to Get a U. S. Government Job," list of positions, and full particulars telling how to qualify for them.

Name.....

Street.....

City..... Age.....

How to Make Your Own CABINETS, BOOKCASES and WALL SHELVES

5 Day FREE Trial



Now Build at Big Savings—With Few Tools

You don't have to be a craftsman or understand blueprints. GIANT SIZE BIG HOME-PROJECT CRAFTSMAN MANUAL shows step-by-step, with easy-to-understand illustrations how to make useful things and earn or save hundreds of dollars. Detailed drawings so simple even a child can understand them! Guides you every step on 77 up-to-date projects.

Make These Things
Wardrobe Chests, Dresser, Night Table, Breakfast Cupboard, Phonograph Record Cabinet, Modern Chest Units, Sewing Cabinet, Book Shelves, Wall Shelves and dozens of other pieces.

Big Money-Market for Every Project Made
These hand built pieces of furniture bring many dollars in the market. Share in the profits to be made in this lucrative field. Cash in on this golden opportunity.

Enrich Your Own Home

The 27 styles of cabinets alone, shown in this wonder-book can produce outstanding results for you—watch your friends gasp when they see the practical bookcases and magazine racks you make. Turn out modern cabinets, shelves, hanging racks, chests and dozens of others like magic. 630 Photos in a big 9"x12" book. Just follow the advice of experts and you will have the things you want. Complete drawings make every job so easy you will marvel at how quickly you turn out fine pieces.

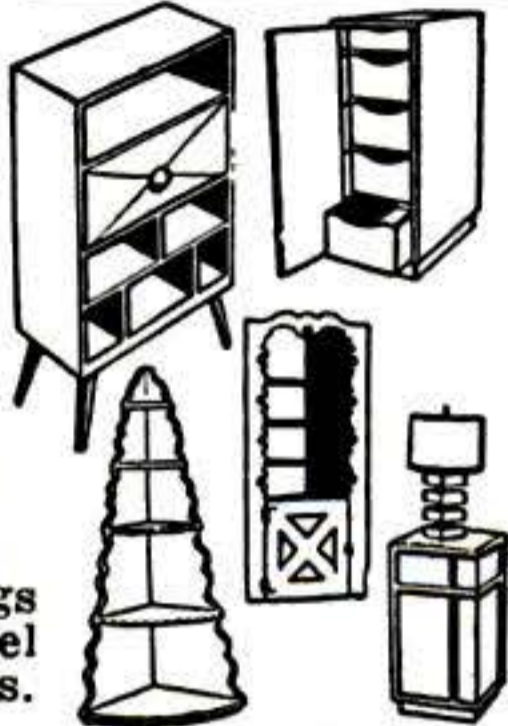

GET STARTED NOW

SEND NO MONEY. Risk Nothing—Just send name, address. Use CABINETS, BOOKCASES AND WALL SHELVES for 5 days FREE. If not delighted, return the book within 5 days and owe nothing or keep it and send only the low price of \$3.95 (plus postage.) Or send \$3.95 now and we pay postage. (Money back guarantee). Order now from

THE HOME CRAFTSMAN

Dept. PS-1, 115 Worth St. New York 13, N.Y.

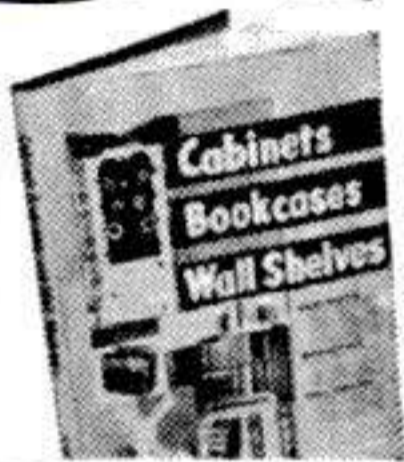

STUDY

- MUSIC
- ARTS
- SCIENCES

NOW IN YOUR OWN HOME

All pianists:—Quickly improve your Technique, Sightreading, Accuracy, Memorizing thru remarkable Mental-Muscular Co-ordination. Amazing results—used by thousands. Also complete Modern Popular or Classical Piano Studies, Harmony, Composition, Counterpoint, Arranging Courses, Teacher Certificate; Diploma. Studies in beginners Art, Dramatics, Public Speaking, Effective Speech, Journalism, Advertising, Psychology, Child Psychology, etc. Unique, easy-to-understand, Home Study lessons, personally supervised by eminent educators, assure success (our 25th year) for career, education, personal enjoyment. Write at once—Today for Free Booklet, sample lesson (indicate subjects). To persons over 18 only.

BROADWELL STUDIOS Dept 19A Covina, Calif.

new, easy way to.. STRIPE with PAINT

Do Perfect Paint Striping at Home with New Kind of PAINT STRIPING TOOL

This Master Painters' Striping Tool makes it easy to do expert striping on furniture, bikes, model planes, autos, signs, toys, linoleum, wall board, etc. Makes plain, painted walls look like tile. Paint straight lines... curved... circular or evenly spaced parallel lines the same way a professional painter does. Simply fill Tubular-Glass Paint Fountain with any color paint and wheel tip feeds paint evenly. Tips interchangeable—jaws split apart for easy cleaning. Tool complete with tips for 1-16 in. stripe only \$1.00 postpaid. Other complete tools with 1-64, 1-32, 3-64, 5-64, 3-32, 1-8 inch tips, \$1.50 ea. Extra tips — 75c each. **COMPLETE KIT** with tool and 7 tips, \$5.00. Here's the handiest tool in your whole painter's kit. C.O.D.'s post. coll.



DEALERS
Paint Striping Tool
packed in attractive display cartons of 1 doz. Fast, profitable seller. Write for illus. circular, discounts.

Just the tool you've been waiting for! New PAINT STRIPING tool gives "professional" results every time, yet simple and easy to use as a fountain pen. Adjustable guide keeps lines straight as an arrow. Just as easy to make curves or free hand designs. Adds new beauty and finished look to everything you paint. Send dollar today.

WENDELL MFG. CO., 4234 N. Lincoln Ave., Dept. 2-A, Chicago 18, Ill.

Improved Americanized

JUDO

"THE BIGGER THEY ARE — THE HARDER THEY FALL!"

Two Big Books Clearly Illustrated. Over 1200 Show-How Photos. Many New Holds! 71 Complete Lessons.

Protect yourself and others. Size and strength mean nothing. Knowledge and skill enable you to master any situation even against biggest bullies and armed thugs. Illustrations showing each hold from start to finish. Complete satisfaction guaranteed or your money refunded.

NOW BOTH BOOKS ONLY \$5.00 pp'd.

or \$3.50 ea. \$1.00 deposit with C.O.D.'s.

No C.O.D.'s outside U.S.A.

IMPROVED JUDO, INC. Dept. PS1, P.O. Box 7355, Sta. L, Los Angeles, Calif.



10 DAY FREE TRIAL!

GOLD - SILVER - COINS



Easily located with new Light-weight M-Scope Detector. Superior performance, lowest price, monthly payment plan.

FREE LITERATURE

FISHER RESEARCH LAB., INC.
PALO ALTO CALIF.

PLASTICS CATALOG

Small Quantities—SPECIAL PRICES—Large Quantities
There's more information and tricks-of-the-trade and a larger variety of plastics materials listings packed into this catalog than you've ever seen before. Sheets, rods, tubes, casting, draping, molding plastics, supplies, findings, etc. We make our own Carving Dyes. "Gem-Coat" Fiberglass and Polyester coating. For fast, courteous, personalized service, **TRY US!** CATALOG 10c—25c Airmailed in U. S.

GEM-O'-LITE PLASTICS CO.
5350-C Riverton Ave. North Hollywood, Calif.

MAKE MONEY with Bostonian SHIRTS

Take orders for famous line finest quality dress and sport shirts. Also women's tailored blouses. All styles, fabrics, colors, sizes. *Low Prices.* No experience needed. **FREE** Big, beautiful Sales Kit with actual fabric samples. Send no money, but rush name now! **Bostonian Mfg. Co.,** 89 Bickford St., Dept. M41, Boston 30, Mass.



RUPTURE!

An amazing Air-Cushion Invention allows body freedom at work or play. Light, neat, cool, sanitary. Durable, cheap. Day and night protection helps Nature support weakened muscles gently but surely. No risk. **Sent on Trial!** Write NOW for free Booklet and **Proof of Results.** All correspondence confidential.

Brooks Company, 374 State St., Marshall, Mich.



DRIVING COMFORT at its best! The New ELECTRIC THROTTLE With Foot Control

The electric throttle ("Speed-selector") sets whatever speed you choose electrically—releases instantly at a touch on the toe-button, or by applying foot brake. **Banish foot and back strain for good!** Install it yourself. Price **\$17.50 F.O.B.** Check or C.O.D. Salesmen, Dealer and Manufacturer agent inquiries welcome.

WRITE FOR DETAILS
D & M MFG. CORP., Anderson, Ind.

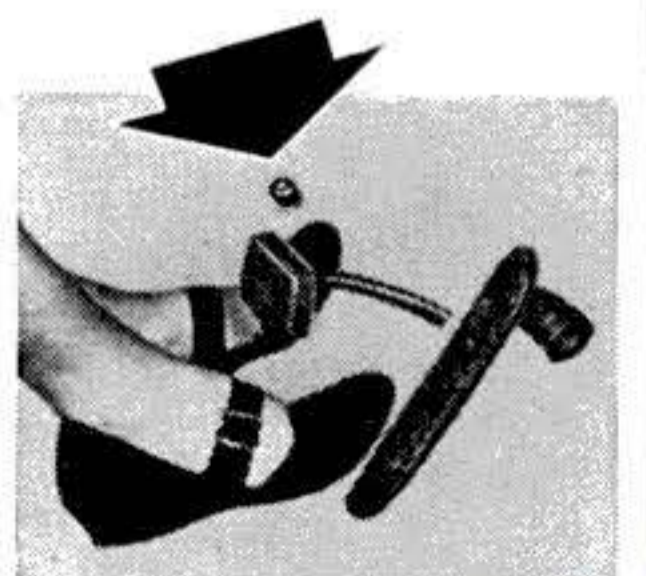

MONTH AFTER MONTH, YEAR AFTER YEAR, YOU SEE OUR AD. REMEMBER IT'S DANGEROUS to pay less if you want the finest nonskid USED tires.

GOOD YEAR Firestone

GOODRICH, UNITED STATES, GENERAL, & OTHERS, NOT RECAPS

Our policy is to select your tires so carefully, as if our very future depended on the service given by that particular tire.

FREE TUBE WITH "ALL" BLATT'S GOOD GRADE TIRES

GOOD GRADE, 16 MONTHS GOLDEN RULE GUARANTEE BOND.	
600-16 \$4.14	700-15 \$4.54
650-16 5.42	670-15 4.74
700-16 5.04	710-15 4.94
650-15 4.44	550-17 4.64
650-20 \$7.94	32x6(8) \$ 8.64
700-20 8.54	32x6(10) 9.94
750-20 8.64	900-20 13.94
825-20 15.92	1000-20 13.94

FINEST GRADE, 26 MONTHS GOLDEN RULE GUARANTEE BOND THIS GRADE MADE THE BLATT NAME "WORLD FAMOUS."

450-20 \$6.00		450-21 \$6.00		700-15(6) \$10		750 16(8) \$15	
600-16 5.49	650-15 5.95	600-20 9.94	900-20 18.54	650-16 6.42	670-15 6.24	650-20 9.94	1000-20 18.54
700-16 7.94	700-15 6.54	700-20 11.94	1100-20 18.54	750-16 7.94	710-15 6.34	32x6(8) 10.54	1000-22 17.54
550-17 5.94	760-15 6.54	32x6(10) 13.92	1100-22 18.54	525-18 5.94	820-15 7.04	750-20 12.54	1200-22 22.54
650-19 9.00	475-19 5.94	825-20 22.84	1100-24 21.54				

Factory Rebuilt Nu-Tred Snow Tires 26 Month Guarantee		Military • Not Recaps • Rugged	
640-15 650-15 550-16	750-20 STD \$10		
550-15 700-15 600-16	" RUGGED \$16		
670-15 760-15 650-16	750-16 RUG. \$19		
710-15 820-15 550-17	900-16 RUG. \$11		
ANY SIZE \$11			

BLATT BLATT BLDG., GIRARD & LANCASTER AVES., DEPT. P.S., PHILADELPHIA 31, PA. Send check or money order and this ad for rush shipment. We won't ship a tire we wouldn't use. The name to trust in rubber. PRICES SUBJECT TO CHANGE Shipments RUSHED Down South. Up North and Far West

SENTINEL GALVANIC ANODE KEEPS RADIATORS CLEAN

Stops Engine Rust, Reduces Cooling System Repairs, Lengthens Engine Life!
Engine block corrosion from electrolytic action causes clogged radiators! Sentinel Anodes stop corrosion, keep cooling system clean. Block stays clean, cooler, so improves cylinder lubrication, retards ring wear and sludge formation, lowers oil consumption. Keeps anti-freeze clear. Anyone can install. Guaranteed. Rush check, M.O. or C.O.D. or write. **SENTINEL MFG. CO., P. O. Box 6097A, Seattle 88, Wash.**

NEW TINYTONE RADIO

Really Works—World's Smallest Carry in your pocket. New Preset Crystal eliminates All Tubes, Batteries or Electric "Plug-ins" Forever! Sweep band dial—Beautiful Red Plastic case. **GUARANTEED TO WORK** on local stations—use most anywhere—home, cabins, farm, etc. **SEND ONLY \$1.00** (bill, ck., m.o.) and pay postman \$3.99 C.O.D. postage on arrival or send \$4.99 for P.P. delivery. **COMPLETE WITH EXTRA LONG DISTANCE AERIAL KIT AND PHONE. LIMITED SUPPLY—SO ORDER NOW! MIDWAY Co. Dept. BPS-1 KEARNEY, NEBRASKA**

MASTER MIND!

Learn Short-Cut Mathematics
Juggle figures, do baffling number tricks. Make people gasp at your marvelous lightning-quick mind. Multiply 4 figures by 4 figures without using old-fashioned multiplication! Big cloth-bound volume; fully illustrated course.
Sharpen up Your Brain Power
Includes worked-out problems, answers, etc. Sensational bargain, only \$1.95, postpaid or COD plus postage. Satisfaction guaranteed or refund. Order this amazing "Short-Cut Mathematics" today!
NELSON-HALL CO., 210 S. Clinton St. Dept. 4A-1 Chicago 6, Ill. \$1.95 Complete

MAKE CRIME YOUR BUSINESS

ON THE SIDE OF THE LAW!
Help fight crime! . . . Earn steady good pay as a Finger Print Expert or Investigator. I.A.S. trains you—by easy, low-cost home study lessons. Learn this exciting work in spare time. Write for full details now!

OVER 800 POLICE BUREAUS...
Employ I.A.S.-trained men . . . proof of what I.A.S. can do. Write today (state age) for details. No obligation. No salesmen will call.

INSTITUTE OF APPLIED SCIENCE
Dept. 1361, 1920 Sunnyside Avenue
Chicago 40, Illinois

OWN a Nationally Advertised Business

Now, we are appointing dealers in U.S.A., Canada, Mexico and foreign countries . . . in territories still open. If you are capable, cooperative and willing to work to enjoy success, we'll establish you in your own business and arrange easy terms to help you get started.

Alert dealers can average \$4.50 hourly gross profit on service they render and \$3.00 on EACH of their servicemen at National Price Guide charges. No experience needed.

Clean Rugs and Upholstery

Duraclean Dealers' businesses are built upon the solid foundation of an international organization with 22 years of Proven Success. Duraclean Service was established to improve cleaning methods for rugs and upholstery . . . to eliminate harsh machine scrubbing . . . to prevent shrinkage from soaking. Instead of floating surface soil down into upholstery and rugs, this amazing process actually removes it!

Protects Against Moths

Here is another year 'round service rendered right in the home, office, or business building—without removing furnishings. Duraproof protects carpets, upholstery, furs, clothing, piano felts and auto interiors from damage by moths or carpet beetles. To our knowledge, Duraproof is the only mothproof service backed by a National Money-Back 4-YEAR WARRANTY.

Voluntary and Repeat Orders

Customers are not merely satisfied—many are enthused with results and tell friends and neighbors. Duraclean is recommended by America's foremost furniture and department stores. Services are **NATIONALLY ADVERTISED** in Quality Magazines to help create still more demand for you and to explain the superior merits of YOUR modern processes and to develop confidence in your service.

No Overhead Expense

Shop is optional! At the start you may want to render service yourself from your own home, on a part time basis. It's easy to learn. Almost every building in your territory houses a potential customer needing one or both services. Even auto dealers buy your Duraclean Service to revive upholstery in used cars.

Two-Way Profit

You enjoy unusual profits on both materials and labor after paying service men and salesmen. Mr. E. Schalchin reported, "Have on hand 5 orders totaling over \$500, obtained from recommendations of customers." J. Dalton says, "Business previous four weeks was \$1,600."

FREE Booklet

If you are interested in an opportunity like this, fill out the coupon today! A letter and 16 page illustrated booklet will explain everything. We furnish electric machines, advertising matter, store cards, introduction slips, sales portfolios, demonstrators and enough materials to return your **TOTAL** investment. You can have **YOUR OWN** business operating within a week after equipment arrives. Mail coupon **NOW** and discover for yourself. No obligation. Easy Terms!



1/4 PAGE

Better Homes and Gardens

"OWN a Business" Coupon

Duraclean Co. 2-181 DURACLEAN BLDG. DEERFIELD, ILLINOIS

With no obligation to me, send booklet and letter giving full details. Tell me how I can OWN a growing business of my own built upon satisfied customers.

Name _____
Address _____
City _____ State _____

Start a Business in Your Backyard



Earn **BIG MONEY**
MAKING
BUILDING BLOCKS

General Concrete Vibrator
BLOCK MACHINE
CAPACITY 1000 BLOCKS A DAY

only \$329 LESS MOTOR
F.O.B. PLANT

SHIPPING WEIGHT 400 LBS.

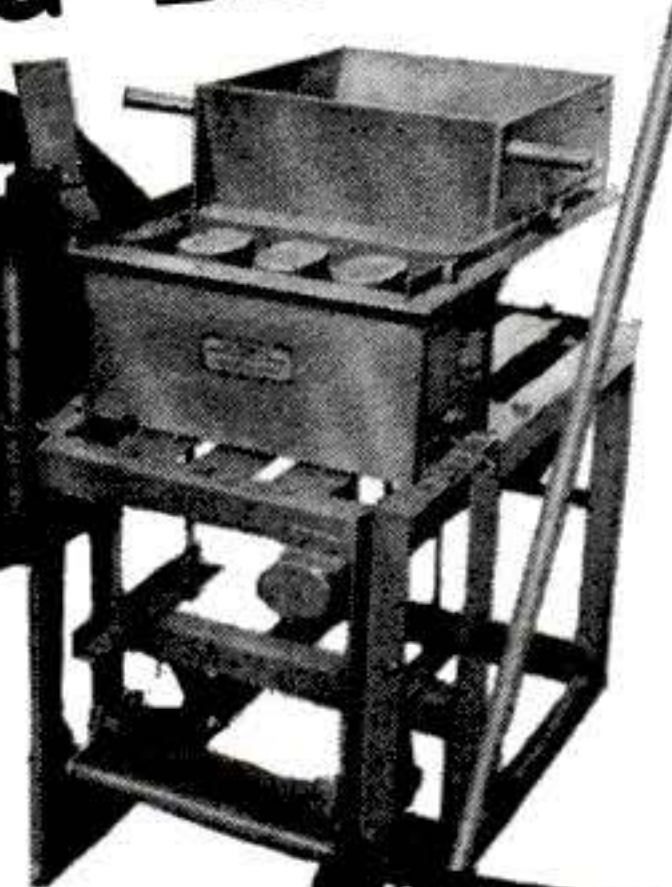

Here is a business you can start on small capital—in your own backyard—that earns 100 to 150% profit, with unlimited opportunities. Make concrete or cinder blocks. Millions used for homes, factories, public buildings, garages. Sell all you make to building trade. Do it with a General—and you're headed for success.

1000 BLOCKS A DAY

The General is a high speed, power-driven block machine at amazingly low cost. Rugged all-steel construction. Simple to operate indoors or outdoors. Makes superior 3 core type block meeting all code requirements. Produces up to 1000 blocks per day. Full operating instructions and mixing formulas supplied. Write for FREE details.

Dealer Inquiries Invited

Wonderful
Book Written
& Illustrated
by Experts



GENERAL ENGINES CO.

DEPT. S-12 • 307 HUNTER ST. • GLOUCESTER, N. J.

Includes floor plans for 6 beautiful, easy to build concrete block bungalows. Shows ways to save money. How to lay blocks, lay out building lines, mix concrete, build steps, porches and concrete floors. Mail coupon at once with \$1.

Name.....
Address.....
City.....Zone.....State.....

● IF YOUR CAR BURNS
● TOO MUCH OIL...

HOLT'S GET
Piston Seal

AN ENGLISH IMPORT

10,000 miles of motor oil economy in every tube. Restores compression, stops piston slap, improves engine performance, and pays for itself many times over in reduced oil consumption. Endorsed by automotive experts everywhere—improves all internal combustion engines. Anyone can install—just remove spark plugs, insert rubber tube and squeeze. Send for complete details—FREE!

AUTOMOTIVE AIDS CO., DEPT. 7-S
201 East 5th St., Plainfield, N. J.

for
QUIET CAREFREE DRIVING

AUTOMOTIVE AIDS CO.
201 East 5th St.
Dept. 7-S, Plainfield, N. J.
RUSH DETAILS ON PISTON SEAL—FREE!



NAME.....
ADDRESS.....
CITY.....STATE.....

CASH FOR YOU WRITING ORDERS!

KENDEX NYLONS ARE FREE

UNLESS SATISFACTORY!

Amazing, but true! The most sensational offer ever made! Earn big money spare or full time writing orders. We deliver and collect. Leading Kendex full fashioned, first quality sheer all DuPont nylon stocking, guaranteed against everything, is now reduced to 98c a pair (including your commission, bonus and postage). If these wonderful stockings run or snag within 1½ months, the full 98c is refunded, so they actually cost nothing unless satisfactory! Write for free sample stocking and money-making outfits free and prepaid. No obligation.

KENDEX CORP., BABYLON 349, N. Y.

Make BIG MONEY!

RAISE CHIN-CHINS
PURE BRED, PEDIGREED, PROLIFIC
CASH MARKETS SUPPLIED for your Production. Pleasant—Easy—Full or Part Time.
Learn HOW these year-round money-makers can produce REAL PROFITS for you!
FREE illustrated Booklet — WRITE TODAY!
ROCK HILL RANCH, SELLERSVILLE 41, PA.

WORLD'S LARGEST BREEDER OF CHINCHILLA RABBITS

Learn to HYPNOTIZE!

Command others with hypnotic power! Amaze everyone with your new spellbinding technique. New easy to master course teaches you this mystic art, quickly, expertly, professionally. Have subjects at your mercy. Make them obey your every desire. Send for this Valuable Book Now! Just pin \$1 to this ad and "25 lessons in Hypnotism" will be mailed to you postpaid. Satisfaction guaranteed or your money back.

Books Publishing Co., 56 W. 24th St., New York 10, N. Y.

FREE—Amazing Book on RHEUMATISM, ARTHRITIS

If you suffer the aches, pains and discomforts of Rheumatism, as manifested in ARTHRITIS, NEURITIS, SCIATICA or LUMBAGO, send today for the FREE Book. It reveals important facts about why drugs and medicine give only temporary relief without removing causes. Explains fully a proven, specialized system of treatment that may save you years of distress. No obligation. Write for this FREE Book today!

BALL CLINIC, Dept. 36, Excelsior Springs, Mo.

TRY HOME STUDY WATCHMAKING

Turn dull winter hours to pleasure and profit. Master watch repairing the thrifty home study way. An exciting hobby or fascinating career. No experience needed. Send coupon today!

FREE Sample Lesson

CHICAGO SCHOOL OF WATCHMAKING

1608 N. MILWAUKEE AVE., DEPT. 412, CHICAGO 47, ILL.
SEND FREE SAMPLE HOME STUDY LESSON

Name.....
Address.....
City.....Zone.....State.....

WAR SURPLUS INSTRUMENTS—WATCHES—MOTORS

ELGIN—WALTHAM—BULOVA



Waterproof, shockproof, Type A-11 hack watch. 16 J black face, white numerals. Sweep second hand. Used by AAF. Built to exact specifications of U. S. Govt. Genuine War Surplus. State first and second choice as limited quantity available. **\$19.75 ONLY**.....

Add \$1.98 Federal Tax



WESTON VOLTMETER

Model 433. 0 to 150 volts. Laboratory type precision built. Hair line pointer on mirror scale. 25 to 2400 cycles. Size: 3 1/2" x 5" x 6". Govt. cost \$85.

Our price

\$29.95



SOUND POWERED PHONE

No batteries needed. Your voice generates current. O.K. for 25 miles. Perfect intercom for shop, office, farm, darkroom. WAR SURPLUS. Orig. Govt. Cost \$58.00 ea., **NOW \$10.95**



RIFLE SCOPE

Precision built to gov't specifications. Adjustment for windage and footage. Complete with Mossberg #9 mount. Add accuracy to your hunting this season. Limited quantity available.....

\$9.95

STEWART-WARNER TACHOMETER

Direct drive recording tachometer. Dual indicator, white hand for R.P.M. while in operation. Red hand for recorded R.P.M. with reset attachment. 0-3,000 R.P.M. Black face, white numerals. 3 1/2" Dial. A \$75 value

\$7.95



115V. DIEHL MOTOR

Easily adapted to grinder, buffer, many power tools. Will drive flexible shaft, etc. Silent. Made by Diehl. Operates on house current 115 v. Balanced bearings. 3450 RPM—60 cycle—1/40 HP. Single or 3 phase (specify in order). Shipping wt. 7 lbs. Cost gov't. \$41.50. Our price, only..

\$5.95

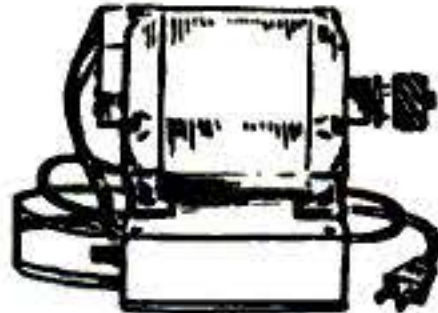

All merchandise guaranteed. Order these Surplus Bargains Today. 20% Deposit on C.O.D.'s Minimum Order \$2.00.

56 to 1 PRECISION GEAR BOX

Dual input. Dust-proof housing. Pre-lubricated bearings. Spline shafts. Terrific torque. Mfg'd by Western Gear Works. Brand New. Shipping wt. 8 lbs. Cost gov't \$125.00. Our cost, only

\$5.95



Semlers' ASSOCIATED PHOTO CO. Dept. P-114 5730 WILSHIRE BLVD., LOS ANGELES 36, CALIF.

New! Amazing MOTOR SENTINEL

GIVES YOUR CAR

- Better mileage
- More power
- Faster starts
- More speed

FREE LIFETIME GUARANTEE



DRIVE UP TO 3,000 MILES A YEAR... GAS FREE!

STOP WASTING GAS

Special **\$3.95** Offer

SEND NO MONEY

Pay postman plus postage or send cash, check, or money order, we pay postage. Keep 10 days. Return for full refund of purchase price if not fully satisfied.

YOUNG PRODUCTS
Department 113 • 2605 Elmhurst
DETROIT 6 MICHIGAN

BROOKS can make a career for YOU

LEARN INVESTIGATIVE PHOTOGRAPHY
LEGAL—CRIMINAL

Securing evidence through ballistic photos, fingerprints, scenes of accidents and crimes is INTERESTING • EXCITING • PROFITABLE

At Brooks Institute, you learn by doing. You use the finest up-to-date equipment and you're trained by instructors, each an expert in his field. Brooks is the only recognized photographic school offering this opportunity to learn legal and criminal photography.

Opportunity knocks — with the click of a shutter. Start your Investigative Career by investigating today... Write for our FREE booklet and full information... Dept. 6



BROOKS
INSTITUTE OF PHOTOGRAPHY

SANTA BARBARA • CALIFORNIA
"PHOTOGRAPHER'S PARADISE...
Where the mountains meet the sea."

SO BADLY NEEDED—

that Our Men are NOW SELLING—

5 to 10 in One Home—

10 to 80 in One Office—

50 to 432 in a Factory.

Men Actually Making \$40 to \$60 A DAY! Right NOW!

Read the facts in the panel at the right. Then you'll understand how Riggs could make \$187.26 in three hours—how Jackman got an order for 432 with a five minute demonstration—why an office girl in spare time could sell 87 in just two calls in one building.

No more tangled phone cords, appliance cords, extension cords on power tools. No more danger of fires from short circuits in broken, twisted wires. No more knocking papers all over the desk every time the phone is used. So badly needed that there are millions and millions waiting for just one demonstration to give orders for five, fifty, or a hundred.

There's never been anything like it for fast

money for any kind of salesman. Companies like Std. Oil, Pure Oil, Bank of America buy in large quantities. Cities buy, States buy. Hospitals buy. Everyone buys. And our salesmen are coining cash, hand over fist.

GET TWO SAMPLES QUICK.

Two models fit all needs. Retail at 95c each. You make as high as 120% profit markup on your cost. Rush name and a dollar bill. We'll send two Coillettes—one of each model, as samples. Money back if you return them in ten days.

The stampede is on. Salesmen and crew managers are throwing other lines overboard. Get in now on the biggest "pay-off" in years.

PAT. NO.
1,790,666



A simple little piece of coiled piano wire takes the kinks out of all electric cords—Re-coils the wire in a neat stack each time it is used—on phones, fans, irons, vacuums, adding machines, power tools. Two minute demonstration sells 8 out of 10 prospects—and almost every prospect buys from 3 to 100. Re-orders will swamp you. You have to see it to understand. Send for two samples today.

MAXILUME CO. Dept. T-9-A, 125 W. Hubbard St., Chicago 10, Ill.

FREE BOOK AND ACTUAL SAMPLE

Screen Print, Dept. 11
1010 So. Los Angeles St.
Los Angeles 15, California
Dear Mr. Nowak: Please rush me FREE BOOK,
ACTUAL SAMPLES, and your amazing new PRINTING PLAN

Name _____
Address _____
City _____ State _____



**IT'S AMAZING! I'll show you
how to make up to \$12.50 per hour
PRINTING
WITHOUT A PRINTING PRESS**

AMAZING NEW COLOR PRINTING METHOD
A fascinating new miracle-way to print—a secret method that lets you print colorful signs, posters, banners, drapes, wallpaper, flags, glass, fabrics—ANYTHING without an expensive printing press or costly equipment. This new process is revolutionizing the entire printing industry—it's one of America's fastest-growing businesses—it's your "chance of a lifetime" to make Big Money Now! Be the FIRST in your area to profit. The secret can be yours—just mail the coupon above today!

EASY TO LEARN! NO EXPERIENCE NECESSARY!
Simple fascinating method! No artistic ability needed. It's possible for anyone (young or old) to make up to \$50 PER WEEK printing in SPARE TIME alone—AT HOME!
START YOUR OWN BUSINESS—BE YOUR OWN BOSS
Wouldn't you be happy if you could take only one hour of your time and \$1.00 worth of materials—and sell your printing for \$15 or more. It's that easy! It's amazing! Your home can be your office—No selling because there's a huge demand everywhere. **GOVERNMENT CONTRACTS AVAILABLE TO BID.** Biggest opportunity in America—costs you nothing to receive all CONFIDENTIAL FACTS—Mail coupon today!

SCREEN-PRINT

1010 S. Los Angeles St., Los Angeles 15, California

- Print paper of all kinds
- FREE OFFER
- PRINT BANNERS
- PRINT FABRICS
- PRINT INSTRUMENTS
- PRINT SIGNS
- FOR SALE
- YOU CAN PRINT ANYTHING WITH
- SCREEN PRINT**

SURPLUS MAIL ORDERS — FREE DELIVERY

The FAMOUS B-15 style FLYERS JACKET

This is the favorite jacket of G.I.'s. Preferred by millions of men, women & children for its warmth, water repellency, light weight and extreme comfort. The outside shell is made of G.I. Army cloth trimmed with a comfortable fur collar. Inside is made of a fine grade wool lining covered by a perspiration resistant sa-teen. The snug fitting cuffs and waist band will keep out the wind & cold. This jacket will resist the roughest wear. Ideal for sports, leisure wear or campus. Through an exceptional purchase we are able to bring you this jacket at the amazingly low price of **\$7.95** Easily a \$15.95 value.



Sizes: 34 to 44

FAMOUS Imported PRECISION 6" Vernier CALIPER

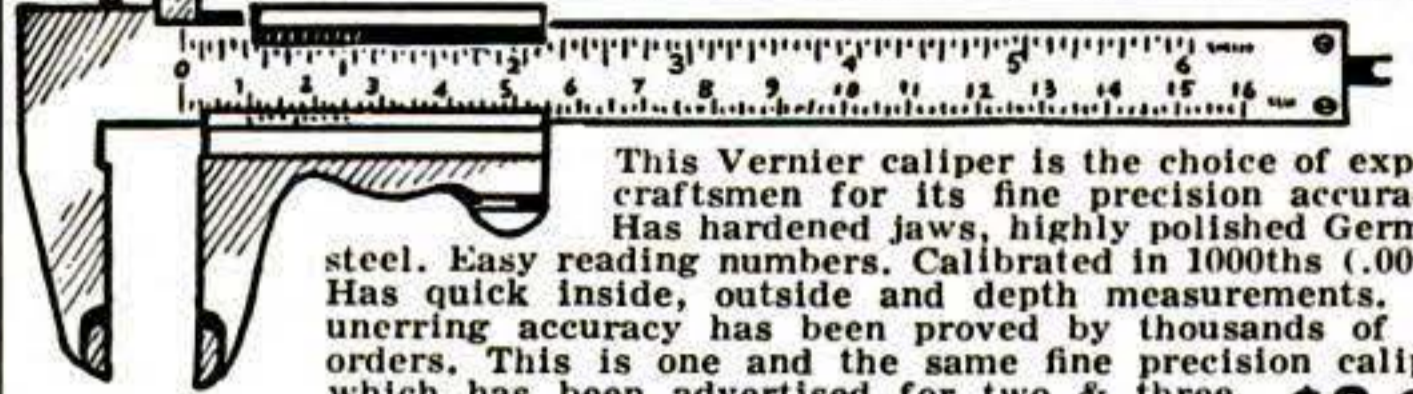

This Vernier caliper is the choice of expert craftsmen for its fine precision accuracy. Has hardened jaws, highly polished German steel. Easy reading numbers. Calibrated in 1000ths (.001). Has quick inside, outside and depth measurements. Its unerring accuracy has been proved by thousands of re-orders. This is one and the same fine precision caliper which has been advertised for two & three times our special price. **\$8.95**
Guaranteed "on the money" or your money back. Don't delay! Order today! Everything sold with an unconditional Money-Back guarantee! **FREE DELIVERY. SEND FOR FREE SURPLUS CATALOG.**

TRANSCONTINENTAL SALES Dept. S. 947 S. Broadway
Los Angeles 15, California

ILLUSTRATED COMIC BOOKLETS
FOR MEN ONLY! POCKET SIZE!



THEY'RE TERRIFIC! PACKED WITH RARE CARTOONS and GOOD CLEAR ILLUSTRATIONS AS YOU LIKE IT. RICH IN FUN and HUMOR. **20 BOOKLETS** ALL DIFFERENT, SENT PREPAID FOR \$1 IN PLAIN SEALED WRAPPER. NO C.O.D.s.

NATIONAL, Dept. 478, BOX 5-STA. E, TOLEDO 9, OHIO

EASY TO LEARN CODE

Learn or increase speed with an Instructograph—the Radio-Telegraph Code Teacher that takes the place of an operator-instructor and enables anyone to master code without further assistance. Available tapes from beginners alphabet to typical messages on all subjects. Speed range 5 to 40 WPM. Always ready—no QRM. Thousands have "acquired the code" with the Instructograph System. Write today for convenient rental and purchase plans.



INSTRUCTOGRAPH COMPANY
4701-P Sheridan Road, Chicago 40, Illinois



Bar Bells

BUY DIRECT FROM FACTORY

\$8.95
up

Approved and Recommended by Karl Koberle. (Foremost Ex-Army Instructor on Weight Training.)

Write for free booklet and price list.

INDEPENDENT IRON WORKS

2416 E. 23rd. Street, Dept. C, Los Angeles 58, Calif.

PROPANE GAS ON YOUR CAR

with normal operation on gasoline. Switch to either instantly—Save up to 1/2 on fuel. **SEND \$2.00** for "How-to-do-it" booklet, photos, drawings and low prices on complete outfits. (Refunded on parts order.) Rush order today—NOW!



LPG PRODUCTS
Dept. PS-1 Kearney, Nebraska



MAKE YOUR OWN!
WITH

GRIFFIN LEATHERCRAFT KITS
Best assortment of tools, materials in U.S.A. Send 25¢ for 116-page catalog. (money refunded first order)
GRIFFIN CRAFT SUPPLIES

SINCE 1924
5626-B Telegraph Ave., Oakland 9, Calif.

**MAKE MORE MONEY IN
MANAGEMENT
PRODUCTION
MANAGEMENT**

Great opportunities today for men skilled in Production Management. In spare time at home add to your present ability the knowledge which can prepare you for a better job and more money. Training built by experienced factory men and taught by management experts. Placement counsel and help. Write today for FREE book "Industrial Management" showing how you can climb higher—faster.

LASALLE Extension University, 417 So. Dearborn St.
A Correspondence Institution, Dept. 183 IM Chicago 5, Ill.

**YOUR FUTURE IS WAITING IN
TELEVISION
THOUSANDS OF GOOD JOBS**

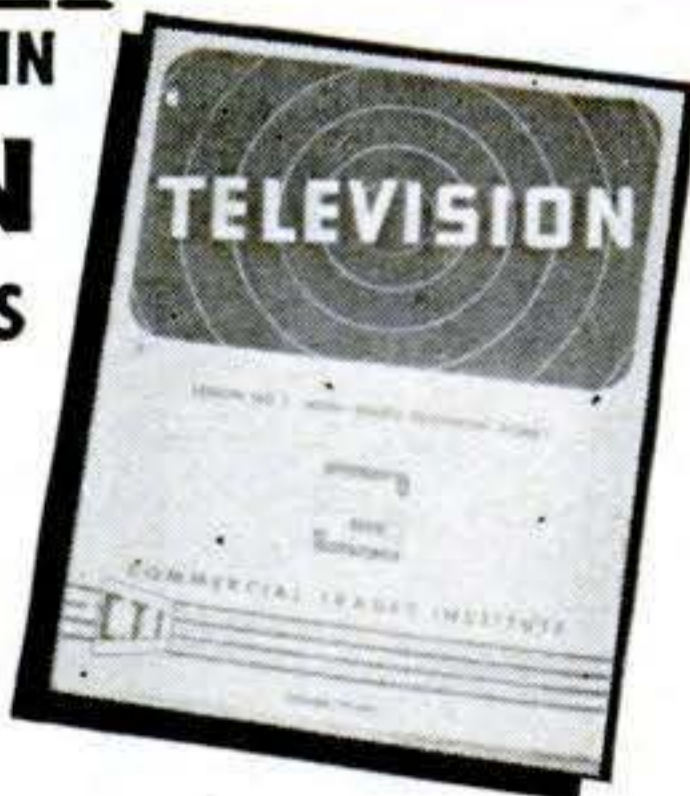

FREE LESSON PROVES YOU CAN LEARN

- TELEVISION
- REFRIGERATION
- UPHOLSTERING
- FOREMANSHIP
- FACTORY MANAGEMENT
- AUTO MECHANICS
- DIESEL MECHANICS
- BODY-FENDER REPAIR
- DRAFTING
- BUILDING CONSTRUCTION
- HIGH SCHOOL

You Build a 16-in. Set — Get 20 Kits

Earn to \$100 a week as a TV service man. Free lesson shows how easy it is to learn at home! C.T.I. sends 20 kits: You build a 12 or 16" receiver. Write today for lesson! Free booklet other courses (left).

COMMERCIAL TRADES INSTITUTE
1400 Greenleaf, Chicago 26 • Dept. E1-1

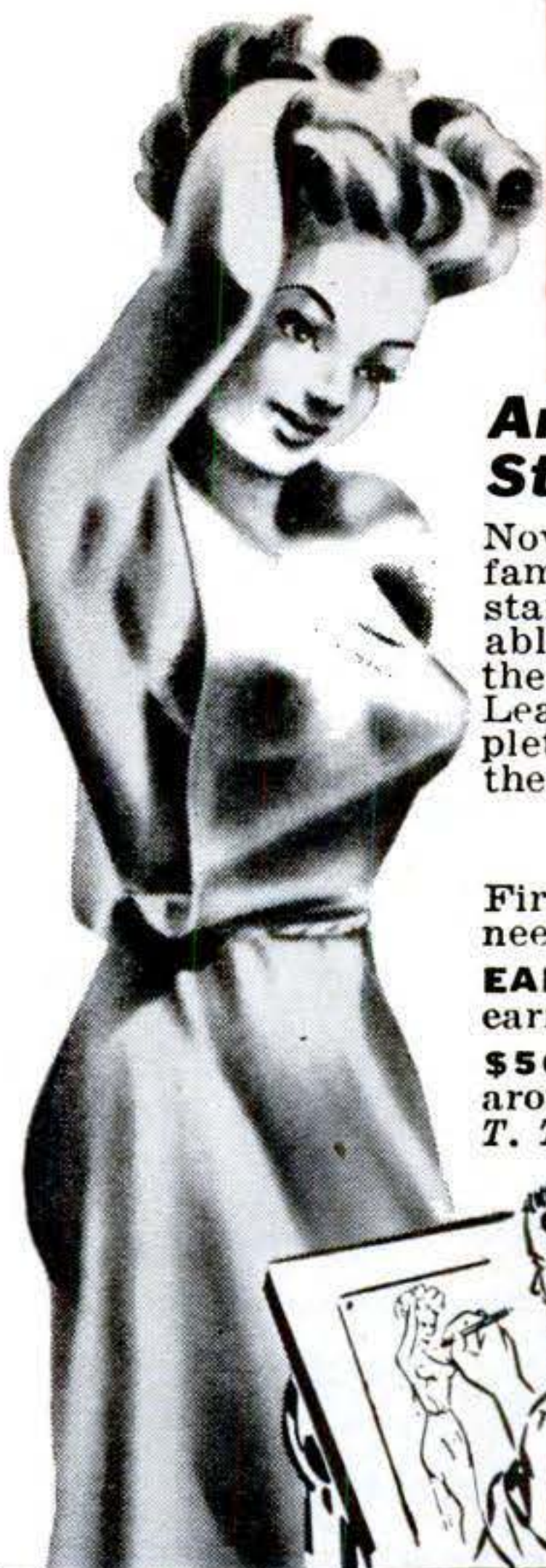

Draw for Money - Become Your Own Boss!

BE AN ARTIST

NEW TRIAL PLAN Reveals Your Talent!

Amazing WSA Way Teaches You to Draw Step-by-Step—at Home in Spare Time

Now you can prove to yourself that you have art talent! Our famous 38-year-old home study method makes it easy to get started. Get the facts about how you can prepare for a profitable career or fascinating hobby. Qualify for a good position in the Exciting world of art—and earn \$75, \$100 and more weekly. Learn Commercial Art, Designing, Cartooning—all in one complete home study course. *You don't need previous experience*—WSA teaches you from the beginning. Low cost—easy monthly terms.

TWO BIG ART OUTFITS INCLUDED

First set of art materials come with first set of lessons. Advanced outfit comes when you need it later in course—all at no extra cost.

EARNED \$300—for one illustration. "WSA has given me the know-how to earn while learning"—*Floyd M. Green, Seattle, Wash.*

\$50 WEEKLY IN SPARE TIME—"Art stores buy all my work. I earn around \$50 a week in just my spare time. I highly recommend "WSA"—*Mrs. T. Teichman, Northfield, N. J.*



WRITE FOR FREE BOOK "ART FOR PLEASURE and PROFIT"

Tells about our course and opportunities for you in Art. See reproductions of student and graduates' artwork and read about results enjoyed by WSA trained artists.

OUR 38TH YEAR

FREE BOOK gives details

WASHINGTON SCHOOL OF ART Studio 131F, Washington 5, D. C.

Send me without obligation, Free Book, "Art for Pleasure and Profit." No salesmen. (Please Print)

Name.....

Address.....Age.....

City.....Zone.....State.....

I am interested in your new Trial Plan

WASHINGTON SCHOOL OF ART



Want Money? Friends? Health?
THE POWER OF ACCOMPLISHMENT CAN BE YOURS!

...WHY SEEK FURTHER? YOU HAVE THE POWER

Whether you desire a greater income, a fine new home, better working conditions, happiness in marriage, or better health, Dr. Ben Sweetland, famous writer, lecturer, and consulting psychologist, offers you a helping hand. People in all walks of life have used his "MAGIC FORMULA FOR PERSONAL ACCOMPLISHMENT" and have found their own vibrant, life-loving personality, the true heritage of every one of us. Dr. Sweetland has found the secret that will allow us to use that power, called by so many names—intuition—revelation—personal magnetism. With his FORMULA you can win success by working *less* hard than you do now. You can push obstacles aside—and accomplish your fondest dreams and ambitions.

HERE'S PROOF!

"Since following the inspiring thoughts given in your MAGIC FORMULA our income has been quite satisfactory; we built a beautiful new home and are driving a new automobile. Can you appreciate our gratefulness?"
(Signed) Mr. C. J. Haaf, Menlo Park

"The MAGIC FORMULA awakens one to a new world. Each chapter has been so thoughtfully planned to carry one to any conceivable goal, and so simple. Happiness, and Contentment are rich rewards I have received through this master-piece."
Mrs. C. W. Saunders, Jr. San Francisco

DO YOU HAVE THE WILL TO FAIL OR SUCCEED?

Dr. Ben Sweetland began life poor, fighting complexes, social handicaps, poor health. At life's blackest moment he saw, as in a flash, the reason WHY. From then on he became the master of a God-given power we all have that is waiting to be used. He has gained success and personal happiness in a large measure. He offers to show *you* how to use this power—make use of age-old secrets that have made men and women throughout history successful—prominent. Secrets that have brought them ever-sought happiness and success—the love of life.

FREE! EXAMINATION REQUEST

Write now for FREE examination request form. Dr. Ben Sweetland's "MAGIC FORMULA FOR PERSONAL ACCOMPLISHMENT" can be yours to examine in the privacy of your own home without trial. Just send us your name and address on a postal card. Do it today; DON'T SEND MONEY—just your name and address.

BEN SWEETLAND FOUNDATION, Suite 201 960 Harrison Street, San Francisco 7, Calif.

HOW TO MAKE YOUR OWN FURNITURE

and save up to 80%!

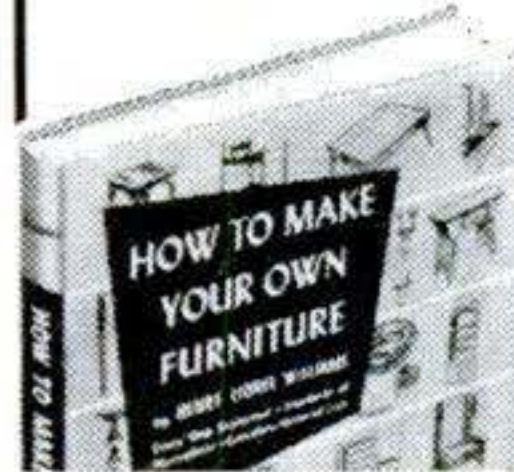

Why pay high prices for furniture? Make it yourself! Easy-to-follow, step-by-step directions in this BIG new book show you professional methods and tricks of the trade. Everything you need to know to make attractive, sturdy pieces for every room in the house. Have fun—and save up to 80% of cost of store-bought articles!

You get complete step-by-step directions on how to make: Chest of drawers, Lamp table, Cutlery tray, Drop leaf table, Wing chair, Chaise lounge, Modern bedstead, Framed desk, Corner cupboard, Side chair, Arm chair, Standing bookshelf. And many other useful pieces. ALSO BUILT-INS SUCH AS: Recessed bookshelf cupboard, Closet and dressing table alcove, Corner seat, Divan with drawers, Bathroom, kitchen or bar counter, Closets, Bunks, Desks, AND MUCH MORE!

Every job explained in careful detail. Large, clear illustrations show exact working procedure for each step. Professional methods given for cutting and joining operations; scraping, raising the grain, staining, varnishing, bleaching, toning, antiquing; designing furniture; etc.

FREE 10-DAY TRIAL. Send no money. Just mail coupon to get "HOW TO MAKE YOUR OWN FURNITURE" on free trial. After 10 days, return and owe nothing—or keep it and send low price of only \$3.95 plus few cents postage. Mail coupon NOW.

Simmons-Boardman Pub. Corp. 30 Church St., New York 7, N. Y.

PS-152

Send me "HOW TO MAKE YOUR OWN FURNITURE" for FREE 10-DAY TRIAL. I will either return it in 10 days and owe nothing—or send you \$3.95 (plus postage) in full payment.

Name _____

Address _____

City _____ Zone _____ State _____

() SAVE! Send \$3.95 WITH THIS COUPON and we will pay postage. Money back if you return book.

MAKE GOOD MONEY
LEARN
Skil-Weaving
(French Invisible Reweaving)
SPARE TIME AT HOME



MONEY MAKING SECRETS
Men-Women make good money at home—profits up to \$5 an hour, spare or full time. Reweave burns, tears, moth holes in suits, dresses, etc. **NO PREVIOUS EXPERIENCE NEEDED.** New device—the Visual-Weaver—prepares you quickly. Complete instructions include not one or two methods but full training on French Invisible reweaving, Silk-Thread Stoving, Piece Weaving and Tailor's Patch.

NO EXPENSE FOR MATERIALS
Big profit orders come from Homes, Cleaners, Dept. Stores—also Mail Orders. You get detailed plans for starting spare time and building to a full time professional reweaving studio. **SKIL-WEAVERS GUILD** Membership gives you advantage of our national advertising.

EVERYTHING SENT AT OUR RISK
Complete step-by-step **SKIL-WEAVE** instructions, 40 piece kit, Visual-Weaver and 8-point plan for financial independence sent to you for leisurely no-risk examination. Read all the secrets of this little known, highly paid profession—then decide if it is the opportunity you seek for extra money at home. **WRITE NOW** for full, **FREE** details. Airmail reaches us overnight.
SKIL-WEAVE CO.
1715-FL Westwood Blvd., Los Angeles 24, California.

READING-MAGNIFYING EYE GLASSES BY MAIL
30 Days Trial



Write Today for Free Catalog. Send no Money
ADVANCE SPECTACLE CO., Inc.
537 South Dearborn Street, Dept. SP-1, Chicago, Illinois

FULLY GUARANTEED TIRES COST LESS!

Nationally famous **FIRESTONE, GOODRICH, U.S. ROYAL, GOODYEAR,** and other makes. Every tire selected and inspected for your safety.

NEW TREAD TIRES GUAR. 24 MOS. (Mud & Snow Tires \$2. Extra)											
550x16	9.98	600x16 (6)	11.98	650x20 (8)	21.95	700x16 (6)	16.48				
550x17	9.98	650x15	11.98	640x15	10.98	710x15	12.48				
600x15	9.98	650x16	12.48	670x15	11.98	760x15	13.98				
600x16	9.98	650x16 (6)	14.48	700x15	13.48	820x15	14.98				
GOOD TIRES GUARANTEED 12 MONTHS											
600x16	4.14	700x16	5.14	32x6 (8)	8.84	825x20	14.24				
650x16	4.54	670x15	4.74	32x6 (10)	10.84	900x20	13.34				
650x15	4.34	650x20	7.84	750x20 (8)	8.54	1000x20	14.14				
700x15	4.64	700x20 (8)	8.94	750x20 (10)	9.94	1100x20	16.14				
AAA PREMIUM GRADE GUARANTEED 18 MONTHS											
600x16	5.58	700x16 (6)	7.98	600x20	9.78	825x20	18.68				
600x16 (6)	6.58	750x16 (6)	8.98	650x20	10.88	900x20	18.98				
650x16	5.98	820x15	7.48	700x20	12.88	1000x20	19.98				
650x16 (6)	6.98	710x15	6.48	32x6 (8)	10.48	1000x22	21.98				
650x15	5.98	550x18	5.98	32x6 (10)	12.48	1100x20	20.98				
700x15	6.68	760x15	6.78	750x20 (8)	12.98	1100x22	21.98				
700x16	6.78	550x17	5.88	750x20 (10)	14.98	1100x24	23.98				
MILITARY SPECIAL											
AA Guaranteed 12 Months—				MILITARY							
900x16 11.98 900x20 19.98				New Tread Guar. 24 Mos.							
750x20 12.89 1100x20 21.98				600x16 10.98							
AA GUARANTEED 18 MONTHS				600x16 (6) 11.98							
900x16 14.98 • 750x20 16.48				750x20 (8) 26.98							
Passenger Tubes—Water Tested—All Sizes...\$1.25											
Truck Tubes—Water Tested—All Sizes...\$2.95											

Largest stock of used tires in the East. Thousands of satisfied customers. Write for sizes not listed
MONEY ORDER OR CHECK WITH ORDER. NO C.O.D.'s
PYRAMID TIRE CO.
1333-35 North 5th St. Dept. S., Phila. 22, Pa.

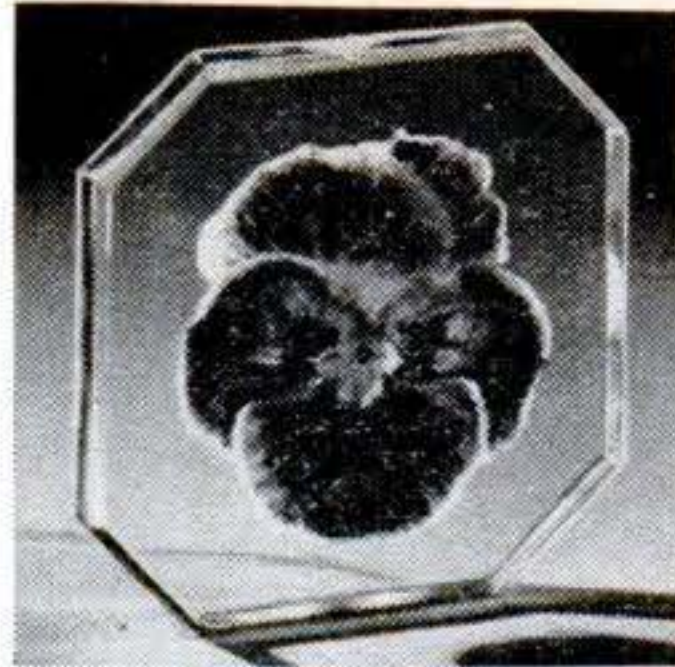

REAL PANSY COASTERS

Now create new and truly different gift articles like the beautiful pansy coaster shown—made by embedding *real* pansies in Castolite—the “magic” liquid casting plastic. With our simple step-by-step method you can make hundreds of valuable articles, including

smart costume jewelry, chic Hi-Style buttons, colorful key tags, tie-clasps, cuff links, plaques, tiles, many other things. Send 25¢ for Big Castolite Creations Manual. **FREE** with Manual, inspiring New Home-Success Plan. Write:

CASTOLITE CO., Dept. A-2, Woodstock, Ill.

ANALYZE HANDWRITING

MORE INCOME, Prestige, Success. Fascinating uncrowded profession-business, full or spare time. **FREE** illustrated lesson & Year Book shows how men and women in home, business and professions analyze handwriting to **understand people, MAKE MONEY.** **FREE** lesson and information about unusual opportunities if over 21.



I. G. A. S., Inc., 715 Wilhoit Bldg., Springfield, Mo.

A POSTCARD CAN PUT YOU IN A FINE BUSINESS!

Rush Card TODAY for FREE SELLING OUTFIT
Get in highly profitable, repeat-order shoe business! Sell amazing line of Air-Cushion Innersole comfort shoes to friends, neighbors, fellow workers. Dress, sport, work and safety shoes for men, women. Never sold in stores. Make \$10 to \$75, as much as \$200 monthly just in spare time. No investment. Send card TODAY for **FREE SELLING OUTFIT!**



CONSOLIDATED SHOE SYSTEM
Box C1-70 Chippewa Falls, Wisconsin

BEING PUSHED AROUND??



Why take any more nonsense from bullies, wise guys and other pests? The next time they try to act smart—give them the surprise of their lives! It's easy when you know **POLICE JIU JITSU!** This complete, fully illustrated course comes to you in one volume. The same as taught to police, marines, “G” men, soldiers, sailors and members of the U. S. Coast Guard. By all means, just pin \$1 to this ad and we will send **POLICE JIU JITSU** to you post-paid by return mail. Satisfaction guaranteed or your money back.

BOOKS PUBLISHING CO., 56 W. 24th St., N.Y. 10



KEYS-DUPLICATED

BY MAIL—3 for \$1.00
plus 25c for postage

Any 3 keys quickly duplicated. Return mail service. Quantity club orders. Keys fitted to locks. Combinations changed or mastered. Auto keys by code. Guaranteed to work or money back. Send check, cash or money order to:

PEARLBROOK KEY SHOP
5196 PEARL RD., CLEVELAND 29, OHIO

Fix It Yourself

Save yourself a lot of expense by doing your own odd repair jobs. Get this new addition of a famous book, showing with diagrams and directions, how to fix and repair furniture, electric outlets, windows, doors, leaky pipes, floor boards, chimneys, boilers, weather proofing, painting and hundreds of other construction and repair jobs. Picture diagrams show how each job is done. Full cloth bound de luxe edition only \$1.49.

POPULAR SCIENCE MONTHLY, DEPT. 152
353 FOURTH AVE. NEW YORK 10, N. Y.

SW-54 \$49⁹⁵



Amazing broadcast and shortwave radio by the makers of professional radio equipment for the

KON-TIKI

expedition of book and movie fame

COVERS THE RADIO WORLD!

Covers all frequencies (broadcast, police, ships, aircraft, amateur) between 540 kcs. and 30 mcs. Uses new miniature tubes for maximum sensitivity. Precision-built. Measures only 11" x 7" x 7"!

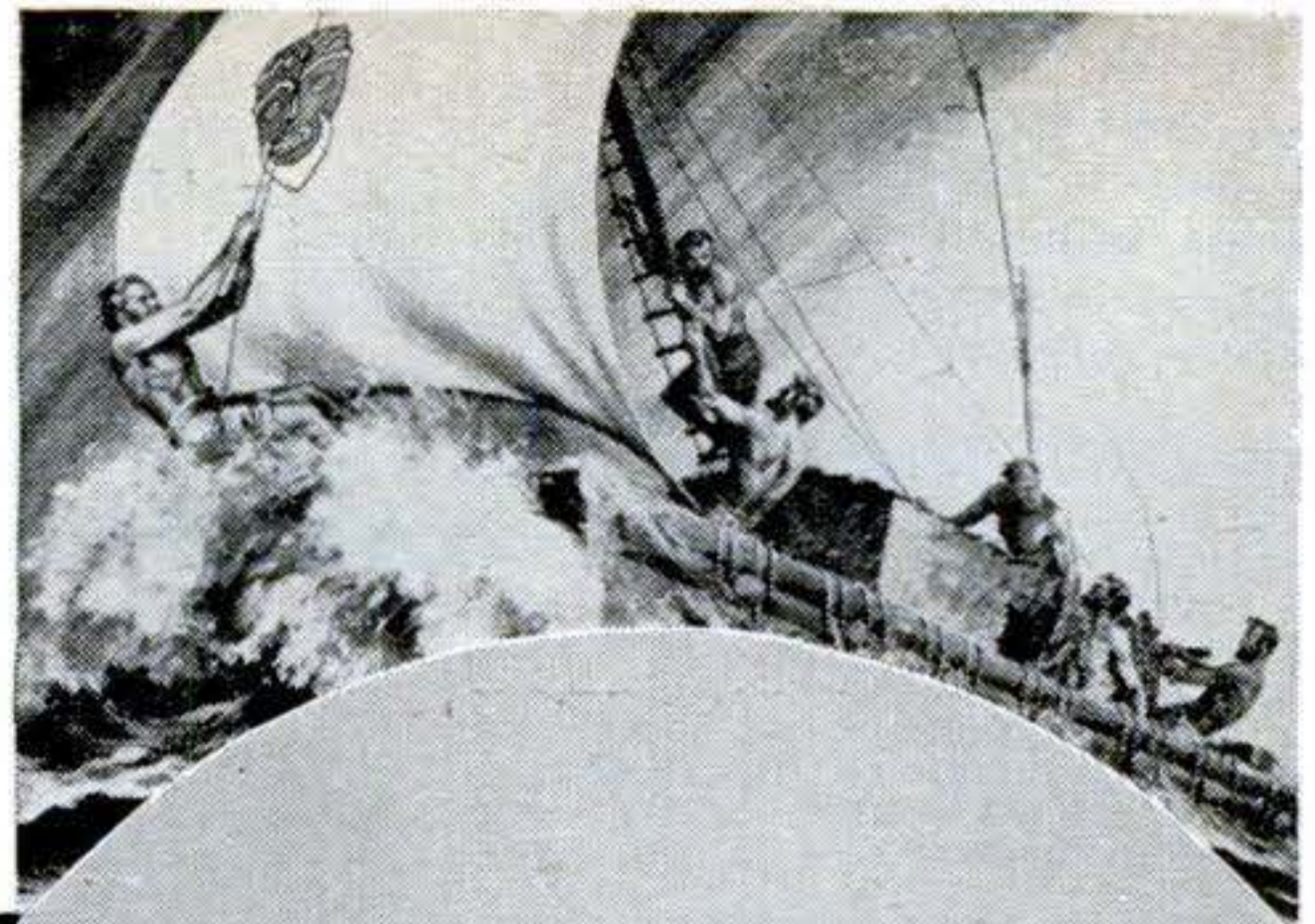

Yes, a radio receiver and transmitter built by National, world's most respected maker of professional radio equipment, kept the famed Kon-Tiki Expedition in touch with civilization despite storms, salt spray and even total immersion! Now, at modest cost, you can enjoy a broadcast and shortwave radio with the same rugged, built-in dependability!

Write for name of nearest supplier.

National

©



EST.

1914

NATIONAL COMPANY, Inc.

MALDEN, MASSACHUSETTS

Save up to 70%—Our Special Buy Gives You These
CAR and TRUCK BARGAINS
ARE YOU LUCKY IF WE CAN FIT YOUR CAR
Chrome Plated Grille and Fender Guards
Custom Fit for following cars:

- '49 Buick Rear
- '46-'48 Chrysler Rear
- '49 DeSoto Rear
- '49 Dodge Front and Rear
- '49-'50 Ford Front
- '51 Henry J Front
- '50 Hudson Pacemaker Front
- '49-'50 Kaiser Front and Rear
- '49 Mercury Rear
- '46-'48 Nash Front and Rear
- '49 Plymouth Rear
- '46-'48 Pontiac Streamliner and Torpedo Rear
- '49-'50 Pontiac Front
- '49-'50 Studebaker Champion Front



Reg. \$12.50 to \$15.00 Value
\$4.50 Each

FLO-JET GUN

Multi-purpose gun for cleaning cars, trucks, basement floors, porches, screens, windows, siding, fertilizing lawns, spraying insecticides.

Can holds detergent, fertilizer or insecticide. Nozzle attaches to garden hose. Cleans up to 20 feet away under normal water pressure. Uses either liquid or powder detergents. No moving parts. Rust resisting. Not an ordinary siphon.



Regular \$2.79 **\$1.69**

TRAILER AXLE ASSEMBLIES. 1 1/2 inch square and round axles 65 inches long. Complete with hubs, grease caps, bearings, and heavy 16 inch wheels and hub caps. No brakes. Regular \$39 Value **\$24.95 Each**

BARE TRAILER AXLES ONLY. 1 1/2 inches square only. 65 inches long. Regular \$10.95 Value. **\$7.50 Each**

CAR OR TRUCK SWITCHES for speed control of small motors such as heaters, defrosters, or dim dash lights. 3 speeds plus off position. Fuse type. Threaded mounting bracket. Just pull out to pick the speed you want. No knob. Regular \$1.25 Value. **.69c**



ORDER NOW—QUANTITIES ARE LIMITED

If interested in 6 or more trailer axles or 100 or more of the other items, write for special wholesale prices. **ALL PRICES F.O.B. CLEVELAND.** Send Cash with Order and Save C.O.D. Fee. 25% Down on C.O.D. Orders. Money Back Guaranteed if Not Satisfied.

Address Desk PS-1 for Faster Service

KAPLAN AUTO PARTS
(WHOLESALE AND RETAIL)

5050 Pearl Road Cleveland 9, Ohio

GROW Living MIDGET TREES!

EARN \$1000 PER HOUR!

- AT HOME
- IN SPARE TIME
- NO EXPERIENCE NEEDED



It's new! Amazing! At last, the secret of growing miniature (MING) trees can be yours. FULL GROWN, dwarf trees—only a few inches high. Beautiful miniature fir, orange, oak, Chinese elm, peach, pine, cypress—any kind! ALL BLOOM and even BEAR FRUIT. All perfect healthy specimens—but miniature in size! Make costly home decorations and expensive centerpieces. (SOLD FOR OVER \$1,500 EACH) Big demand. Costs only pennies—takes only minutes per week. IT'S EASY! Fun! A new fascinating hobby—a new fabulous \$\$\$\$ business. Send for free secret plan details and real seed.

HELP US FILL HUGE DEMAND!

These trees are being demanded by STORES CLUBS • HOTELS • FLORISTS • HOUSEWIVES • INTERIOR DECORATORS • COLLECTORS • HOBBYISTS—A Big Money Opportunity FOR YOU.

FREE! GENUINE SEED AND PLAN!



NATIONAL NURSERIES, Dept. N1
8620 South Ruthelen Avenue
Los Angeles 47, California
Rush me FREE plan and seed IMMEDIATELY!

Name _____
Address _____ Zone _____
City _____ State _____

Classified Ads only 80c per word per insertion, payable in advance. Minimum ad 10 words. To be included in March issue, copy should be in our office by January 24. No cancellations accepted after January 15.

CLASSIFIED OPPORTUNITIES

POPULAR SCIENCE MONTHLY-351 FOURTH AVE., NEW YORK CITY 10

1 AUTOMOBILES & MIDGET CARS

SUBSTANTIALLY increased speed and acceleration without disadvantages of regular souping-up. Detailed instructions \$1.00. Webb Automotive, 251 W. 8th Ave., Columbus, Ohio.

SAVE—California Custom Accessories headquarters. Buy direct from original designers. Chrome dash panels, electric push button door-trunk conversions, fender skirts, dual mufflers, lowering kits, speed-dress up equipment. 40 page catalog. Hundreds of photos—25c. Eastern Auto, 3319D South Grand, Los Angeles 7, Calif.

NON-profit organization offers literature—old, new and foreign automobiles; shop manuals, engineering papers, data books, glossy photos, free motor magazines. Contact auto nuts everywhere. Write today; get name on free mailing list. Auto Maniacs, Inc., Stockbridge, Michigan.

BUY racing heads, dual manifolds, Hot coils, etc. without money. Information free. Newhouse Automotive Industries, Los Angeles 22.

"CAR Guard" protects your car against theft. Kit and directions \$2.00 postpaid. CarGuard, Montana Block, Livingston, Mont.

"WATER Injection." Also—Economy—Power—Methods. Free illustrated information. Neher Industries, La Verne 6, Calif.

MOTORISTS—Save gas with proven automatic alcohol-water injector! Only \$5.95! Free literature. Vaporizer Company, Box 7033X, Los Angeles 37, California.

MAKE Ford use Diesel fuel \$1.00 for plans. Refiner, Box 292, Columbus, Nebr.

WIGLESWORTH-Chasteen's Automobile History Scrapbook, 160 pages. Old time pictures and advertisements of automobiles from 1899 to 1934. \$1.50. Deluxe binding \$3.50. Wiglesworth-Chasteen, 7134-PS Alhambra, Mission, Kansas.

1903 ORIENT Buckboard 1900 (Approx.) Locomobile Steamer. Good running condition. Make offer. Frank E. Ekas, R. D. #2, Tarentum, Penna.

BIGGEST "Speed Equipment Catalog" in world! Save. order direct—Hollywood Mufflers \$4.95. Dual Mufflers \$18.95. Headers \$27.50. Cut Outs \$6.95. Dual Intake Manifolds \$12.95. Racing Cams \$29.00. Hi-Compression Heads \$26.95. Water Injectors \$6.95. Customizing Kits \$1.98. Chrome Accessories at discounts! Catalog plus "Hot Rod Handbook"—25c. Almquist Engineering, Milford 14Z, Penna. (Dealers Wanted).

NEWHOUSE makes another sensational offer. See page 257. Don't miss it.

2 AUTO SUPPLIES & EQUIPMENT

NEW and used guaranteed parts for civilian and Army cars and trucks. Largest stock in America. Mail orders. Pioneer Auto Wrecking Company, 788 W. 13th Avenue, Denver, Colorado.

1951 EDITION. It's new. It's Different! Get world's largest Auto Accessory & Parts Catalog and save money. Over 50,000 items, including Hollywood Accessories, Hi-Speed Equipment, Rebuilt Engines, all parts and accessories for all cars and trucks. We have that Hard-To-Get part! Jam packed with bargains. Completely illustrated. Send 25c (refundable). J. C. Whitney, 1919-T Archer, Chicago 16.

FROM Speedway To Roadway! Track-proved Hi-Speed Heads and Manifolds for your passenger car! No special tools needed! Increase Horsepower 30%! Astounding Getaway! Illustrated Catalog. (Dealers Wanted). Speedsport, 4866-C Milwaukee, Chicago 30.

LEFTSIDE head and tailpipes for V-8 Ford, Mercury and Olds-88. Smithys Mufflers for all cars. Shipped cod. Send 25c for 1952 Speed Equipment Catalog. Strick's Automotive, Colonial Beach, Virginia.

AIR Horns! Bermuda Bells, etc. Free Catalog: Bill McCanna, 148½ East 40th, New York 16.

GAIN Mileage with Gane carburetor needles. Write Gane, Webster 2, N. Y., for Free Trial.

REMANUFACTURE your automobile or light truck engine from clutch to water pump, or install one of our factory rebuilt units, for 50% new engine cost, units run in and performance tuned under own power. New engine specifications guaranteed. Prices and complete information by return mail. Skaggs Brothers, Dept. A, 5425 South Vermont, Los Angeles.

YES. LaChapelle's patented treatment puts babbitt bearings on the pistons. \$3.00 postpaid. Ferns Products, 8120-D Walnut Dr., Los Angeles 1, Calif. (Data on request.)

"HOW to buy speed equipment without money." No selling. Information free. Newhouse Automotive Industries, Los Angeles 22.

WATER Injector. Build your own economically. Illustrated instructions \$1.00. Box 3066, Glendale 1, California.

SEND for free Life Membership Card. "Water Burners of America, La Verne, California.

MOTORIST save gasoline by Vacuumating overrich mixtures. Fits all cars. For Free particulars write Vacuumatic, Dept. 1835, Wauwatosa, Wisconsin.

MOTORISTS—Stop burning oil, restore motor compression with engineered product. Only \$3.95 Free Folder! Advanced Engineering, Box 7013AA, Los Angeles 37, Calif.

LIGHT Your Powerglide Dial. Free Information. Gaiser, Box 25B, Kokomo, Ind.

HOT Water heater not hot enough? Late Fords and others. Air bleeder valve, diagrams, instructions. One dollar. State make, model, Keith Supply, P. O. Box 342, Mishawaka, Indiana.

"HOW to Soup-Up Your Car"—Hot Rod Handbook plus Equipment Catalog—25c postpaid. Almquist Engineering, Milford 16Z, Penna.

FOR economical operation of cars, trucks, tractors install Octa-Gane Alcohol-Water injector. Write Shade, Webster 2, N. Y.

3 AUTO TRAILERS

BUILD your own trailer! Plans for all kinds. Illustrated catalog 10c. Jim Dandy, 125-S, Wausau, Wisconsin.

4 MOTORCYCLES, BICYCLES AND SUPPLIES

MIDGET Car \$10. Motorbike \$7. Safety-cycle, \$15 less engines; Whizzer motor \$6; Smith motorwheel \$10; Evinrude outboard motor \$8. Four airplane type tires \$3 (mailorder only). Send 25c for new catalogue Number 43, just out listing these and hundreds of other bargains in new and used midget cars, motorscooters, home-builders parts, plans, engines, transmissions, war surplus, etc. (35c by First Class Mail.) Midget Motors Directory, Athens, O.

MOTORCYCLE Magazine — Worldwide Coverage. Yearly Subscription \$2.00. Sample 20c. Motorcycle News, 5424-B Sawyer, Chicago 25.

CATERPILLAR Kid-Size Crawler Tractor—Electric Motor Driven! Rugged full-track pulls loads easily over lawns, fields, pavements. Most sensational child's vehicle made! Catalog free. Mystic River Sales Co., Box 312-Q, Mystic, Conn.

REBUILT Gasoline Engines, \$17.00 to \$37.00. Cauffiel Motor Industries, Temperance, Michigan.

WHIZZER in Schwinn bike \$20; good motorscooter (twist grips) \$22.50; midget car \$15; Shaw bicycle motor \$15. Send 25c (35c first class mail) for catalog #19 jammed with other sensational bargains in wheels, motors, clutches, motorscooters, midget cars, motorettes, motorbikes, etc. Gail, 538 Erie, Toledo, Ohio.

RECONDITIONED motorcycles and motors. Chromium accessories. Complete stock Indian parts. Expert rebuilding. Fast service. Indian Motorcycle Sales, Kansas City 1, Mo.

5 AVIATION

JET Engine plans \$1.00. Very simple. Make Own. J. Symonds, 500 N. Tamarind, Fontana, California.

HELICOPTERS—Blueprints—Construction Kits—Flying Models. State and county distributors wanted. Catalog and information, \$1.00. Refunded first order. Aero-Tech, 601 Jefferson Street, Montgomery, Ala.

6 BATTERIES, GENERATORS, ETC.

EDISON Non-Acid Storage Batteries. Amazing long life. Any voltage. 37 to 600 ampere hour sizes. Lighting Plants, Generators, Motors. Literature. Hawley Smith Co., Croton Falls 2, New York.

7 ELECTRICAL SUPPLIES & EQUIPMENT

LAMPS—Had trouble finding repair parts? Your search is ended. 25c brings 64 page illustrated catalog containing wiring charts, Gyro Lamps, 5402B Clark, Chicago 40, Illinois.

FREE New Catalog. Bargains in Welders, Motors, Generators, Surplus Equipment. Or, Build Your Own Kits—Save. LeJay Company, Minneapolis, Minnesota.

LAMP Supplies — Wholesale — any amounts. Prompt shipment on all parts for repairing and building lamps. Illustrated catalog 15c. Brown Lamp Co., No. 501, Wellston Sta., St. Louis 12, Missouri.

ELECTRIC Pencil: Engraves all Metals. \$1.50. Beyer Mfg., 10511-C Springfield, Chicago 43.

8 WELDING, SOLDERING

A.C. Welders, 4 Sizes. Lowest Prices. Free literature. Holgerson's Service, Canton, Kansas.

9 MACHINERY, TOOL SUPPLIES, ETC.

NEW Pan-American Screw-cutting bench lathes, 10" swing, 38" bed, ¾" hollow spindle, 20" centers, loose change gears, with ¼ H.P. 110 volt motor and reversing switch, \$275.00—Used 14" x 6' lathe, \$150.00—22" x 12', \$550.00—Marine hardware & supplies. Conversion parts for all auto engines. Money Back Guarantee. Conversion Parts Company, 277 Adams Street, Boston 22, Massachusetts.

DRILL Grinder for twist drills, \$2.95. See ad on page 259.

10 ENGINES, MOTORS, ETC.

WINDING Data, listing 225 motors, single and three phase, \$1.00. Motor Data, Box 7631, Kansas City 3, Mo.

REBUILT Gasoline Engines, \$17.00 to \$37.00. Cauffiel Motor Industries, Temperance, Michigan.

11 BOATS, OUTBOARD MOTORS

FASTEST Boats In The World—Build Now. Complete plans available for sleek Three Point Racing Hydroplanes, Runabout and others. Send 25c now for new illustrated catalogue. Champion Boats, Box 9038, Dept. 23-A, Long Beach, Calif.

NEW, used, rebuilt marine motors. Marine conversions, fittings. Free Catalog. Stokes Marine Supply, Dept. 23, Coldwater, Mich.

FULL size, cut to shape boat patterns, blueprints, 7½-38 feet. Illustrated "Build a Boat" catalog 25c (coin). "How to Build Boats" book, \$1.00. Cleveland Boat Blueprint Co., Dept. A-77, Cleveland 13, Ohio.

MARINE conversions for Ford and Jeep engines. Catalog 10c. Lehman Manufacturing Co., 972A Broad St., Newark 2, N. J.

POPULAR SCIENCE OPPORTUNITIES

OUTBOARD Motor Parts—New—Used for all makes. Send stamp for price quotation. Outboard Motor Mart, Inc., 309D Atlantic Ave., Boston 10, Mass.

SAVE 2/3 cost. Assemble your own boat. We furnish parts. No experience necessary. Rowboats, Cruisers. Illustrated Catalog 25c. Midwest Boat Company, Menomonee Falls 1, Wisconsin.

BOATING Bargains—Now you can save on boat needs. Our fall and winter value lists just off press. Assemble your own boat from a dinghy to cruiser. Power it with a Masters rebuilt inboard or outboard motor. All three lists 25c. Free boat fitting list. Act now and save \$\$\$! W. L. Masters & Son, Inc., Dept. S, 212 W. Chicago Ave., Chicago 10, Ill.

CURE that leaking boat with Fiberglas—Plastic covering. Ends caulking and painting. Nationally approved process. Easily applied. Complete instructions. Industrial Plastics, 3807 Harrison Street, Oakland 11, Calif.

YOU can own a fine 14 ft. fishing boat. Build it yourself. Plans, instructions and many construction photographs \$2.00. We'll furnish parts you think you can't make. Dillabaugh Company, Portland 11, Oregon.

12 BODY-BUILDING COURSES, JIU JITSU & ATHLETIC EQUIPMENT

100 TRICK Knockouts for self defense. \$1. 1c each. Priest, Box 251, Evanston 2, Ill.

DEADLY Judo—Fiercest fighting technique. Trick knockouts. (Over 200 illustrated pictures.) Expert instructions—Three volumes Complete \$2.25. Variety House, Box 46-A Wall Station, New York 5.

BARBELLS. Dumbbells. Exercise equipment. Courses. Free booklet. Good Barbell Co., Reading, Penna.

14 FIELD GLASSES, TELESCOPES

GIANT. 100 power astronomical telescope with 6 ft. tripod (10,000 area magnification) Clear Vision full power guaranteed. \$15.00 F. O. B. factory. Suffolk Science Services, Dept. TC, Riverhead, N. Y.

BIGGER and better telescope kits with metal parts direct from manufacturer. Free Bulletins. Esco Products, 911 Willow Ave., Hoboken, New Jersey.

AMAZING prices. brand new precision binoculars. \$16.00 up. Free trial. Folder "Binocular Selecting." pricelist free. Prentiss Importers, Mercury Bldg., West Los Angeles 25, Calif.

"FREE" Catalogue! Thousand war surplus optical bargains. Lenses, Prisms, Telescopes, Binoculars, etc. Send \$1.00 for 10 Lens Hobbyist Set and Project booklet. G. Jaegers, 93-08—95th Avenue, Ozone Park 16, N. Y.

SAVE 50% On New Binoculars! Free Catalog. Free book. "How to Select Binoculars." Write today! Bushnell's, 43-P31 Green, Pasadena 1, California.

WAR Surplus Bargains. Binoculars, Telescopes, Sextants, Millions of Lenses, Prisms, Reticles, Eyepieces, Objectives, etc. Mail 10c for Big "Catalog CN." Send \$1.00 for Stock CN-10-piece Lens Kit and Big Instruction Booklet. Edmund Scientific Corp., Barrington, New Jersey.

FREE 20-page Binocular Catalog. Over 60 different models. United, Dept. A-5416, 9043 S. Western, Chicago 20.

ASTRONOMICAL Telescopes, binoculars, microscopes; bought, sold, repaired. Books, lists 10c. Rasmussen-Reece, Amsterdam, N. Y.

POWERFUL astronomical telescopes easily made. Perfect lenses and instructions; 100x \$3.00; 100x and 200x \$4.00; 100x, 200x and 400x \$6.00. Full power, clear vision guaranteed. Instructions alone 10c. Suffolk Science Service, Riverhead, N. Y.

REFLECTING Telescope Mirrors 3" to 12" diameters. Eyepieces—Prisms—Tubing—Accessories. Priced right. Postcard brings Plans—Lists. Pfeegor Optical Co., PS-1, Sunbury, Pennsylvania.

15 SPORTING GOODS, GUNS, FISHING TACKLE, ARCHERY, TRAPPING

ANTIQU-Modern guns. Bargain list. 10c. Martin Rywell, Harriman, Tennessee.

FISHERMEN—make your own sinkers with our molds. Free illustrated booklet. Reading Instrument Co., Box 78, Reading, Penna.

120 PROFUSELY illustrated pages, antique pistols, swords, daggers, armor, etc. 50c. Robert Abels, PS860 Lexington Ave., New York 21.

GENEROUS Supply, larger, livelier, better fishworms. Send \$2.00. Satisfaction guaranteed. Alton Tozier, Freeport, Fla.

LEARN Gunsmithing! Free information. Gunsmith, 3118 Montrose, Chicago 18, Illinois. We buy, sell, trade.

AMAZING Selection Antique Guns, Colts, Kentuckys, Rarities. Send for Antique-Modern List. 25c. Buy-Sell-Trade. Ed Agramonte, 201 Warburton, Yonkers 2A, New York.

5,000 BARGAINS. firearms, binoculars, war relics, catalog 50c. Smith Museum, Runnemede N. J.

MOLDS "For fishermen, sinker, squids, jigs, and lures" handled and hinged, quality fishing tackle, free catalogue. Sweets Molds, Tonawanda, New York, Box 163.

OVER 500 guns, modern, obsolete. List 10c coin. Ed Howe, 26 main, Coopers Mills, Maine.

17 DOGS, BIRDS, HAMSTERS, & PETS

EARN Up To \$400 Monthly Raising Angora or New Zealand Rabbits. Plenty markets. Particulars free. White's Rabbitry, Newark 35, Ohio.

MAKE Big Money! Raise Chinchilla Rabbits. Cash Markets Supplied. Write Today! Rockhill Ranch, Sellersville 16, Pa.

RAISE Mink; Free booklet, pen plans, inside "secrets" feed care. Mink are money makers. Investigate today. Lawrence Molgard, Brigham City 13, Utah.

WEIMARANERS. Boxers, St. Bernards, Hof Kennels, 5136 Cascade Rd., SE, Grand Rapids, Michigan.

500 BRED Mink Booklet Plans 20c. Lake Ontario Ranch, Gravel Road, Webster, N. Y.

NATURALIST'S catalog 10c. Chameleon 50c. Turtle 50c. 200 Mealworms \$1.00. Quivira Specialties, Topeka 10, Kansas.

RAISE Guinea Pigs. Markets guaranteed. Booklet free. Taylors, B426B, Hapeville, Ga.

RABBIT Raising fulltime occupation. Learn true facts. Subscribe American Commercial Rabbit magazine, Year \$1.00. Sample dime. Box 5142-C, Miami 29, Fla.

CHINCHILLA Purchase Plan, lowest Price possible. Booklet on Raising 25c. Kuhl's Chinchilla Ranch, Britt, Iowa.

19 FARMS, OTHER REAL ESTATE

FLORIDA. New Lake County development adjoining Ocala National Forest. Best fishing, hunting. Safe from bombs. Nice homesites \$245 at \$10 monthly. Folder free. Winifree Vernor, DeLand, Florida.

TWO STROUT Catalogs. East and Midwest Red cover; West Coast edition Blue. Farms, Homes, Businesses, bargains galore. Either Mailed Free. Strout Realty, 255-ZB 4th Ave., New York 10, N. Y.

5-ACRE Florida Garden Farm, high and dry, beautifully wooded, only \$375, payable \$10 monthly. Near famous Panama City Pleasure Resort. World's finest beaches. Wonderful fishing, hunting. Grow fruits, berries, vegetables. Poultry. Glorious climate. Desirable Community. Ideal for vacation or retirement home. Booklet Free. Douglas Wood, Box 873, Houston, Texas.

BIG Free Winter Catalog! Farm and country real estate bargains, good pictures, many states, easy terms, many equipped, businesses. For Special Service, state requirements, desired location. United Farm Agency, 2825-PS Main St., Kansas City 8, Missouri.

WESTERN Ranch Land in Calif., Oregon & Washington. Virgin Timber. Your chance to become independent. Buy Now! From \$10 to \$25 per acre, full price, including 100% Oil & Mineral rights. Easy terms. Send 10c (coin) for Full Details, Catalog, Photos. Pacific Lands, Box 2350-BX, Hollywood 28, Calif.

RAYBURN'S Ozark Guide. Eureka Springs, Arkansas. For homeseekers, tourists. Year, \$1.00.

FLORIDA—5 acres high dry land only \$245.00; \$10 down, \$10.00 month full information. Write G. B. Potterfield, Charleston, W. Virginia.

FARM Ranch Opportunities, favorable conditions. Washington, Minnesota, Montana, Idaho, Oregon, North Dakota. Literature, farm descriptions, specify which state. J. W. Haw, 120 Northern Pacific Railway, St. Paul, Minnesota.

20 TREES, SHRUBS, ROOTS, HERBS

MULTIFLORA Rose, the living self-repairing fence. For ornament, erosion control, windbreak, snow fence, other uses. Rapid grower. Raise from seed. Free planting guide. Woodlot Seed Co., Norway 2, Michigan.

LOMBARDY Poplars, 4 footers, 10 trees \$2.50 prepaid. Instructive list. Willmar Nursery, Willmar, Minnesota.

21 POULTRY & SUPPLIES

POULTRY Farmers—Broiler growers—Turkey raisers read the new American Poultry Journal for latest ideas and greater profits. 12 months, 50c. Special offer, 4 years, \$1.00. American Poultry Journal, 527 South Clark, Chicago.

RAISE Turkeys the new way. Write for free information explaining how to make up to \$3,000 in your own backyard. Address National Turkey Institute, Dept. 57, Columbus, Kansas.

RAISE pheasants on the \$100 week plan. Little capital and space can make you independent. Free details. Great Central Game Management System, Columbus 6, Kansas.

22 PROFITABLE OCCUPATIONS

BE independent, be secure, have your own profitable business—earn \$20.00 and more a day making beautiful, fast-selling lamps at home. No equipment needed. Illustrated course teaches you quickly. Course, parts catalog, wholesale price list—only \$2. Gearon Co., Dept. 200-A1, 27 S. Desplaines, Chicago 6, Ill.

FREE book "How to Make Money With Home Workshop" describes amazing methods used by hundreds of successful craftsmen. Tells what to make. How to sell workshop output spare time. Write at once for details. Remember it's free! Craftsman, 115-B1 Worth St., New York City.

DETECTIVES Earn Big Money. Excellent opportunity. Detective Particulars free. Write, Wagoner, P-125 West 86th, New York 24.

EARN \$4 to \$10 an hour in Your spare time. Qualify for exciting, fast-growing field of Claims Adjusting. Free Book—Now! Write Universal Schools, P-103, Box 8202, Dallas 5, Texas.

WANT A Diesel Job? Our approved, up-to-the-minute Diesel Training Program can help you qualify for steady, big pay jobs or specialized military training. Covers Diesel, Tractor, Heavy Equipment repair, service, operation. Easy to master. High grade mechanics tools, worth \$50.00 come with course. No loss of present income. Job placement advisory service. Investigate! We invite comparison of material and service. Write for information today. Interstate Training Service, Dept. 2A, Portland 13, Oregon.

\$40.00 WEEKLY. Made growing mushrooms. Fresh, Dried, Dominion Patent 331.583, free spawn, North American, 169Y Yonge, Toronto, Canada.

\$5000 FROM half acre growing Ginseng, crop bought, Particulars 10c. Associated Growers, Sperling, Manitoba.

LEARN Watch-Clock Repairing at home. While learning we fix all watches for you. Inquire Modern Technical Supply Co., 55-PS West 42 Street, New York 36, N. Y.

START profitable business at home making quick selling transparent plastic, opaque plastic, plaster articles, etc. Learn mold making, carving, fabrication, mass product production, etc. Free Plasti-Art Book. Advance Trades School, Dept. 103, Chicago, 31.

PRINT Without A Printing Press. Big Money! See page 56.

FREE Book "505 Odd, Successful Businesses." Work home! Expect "Odd"! Pacific-72C, Oceanside, Calif.

POPULAR SCIENCE OPPORTUNITIES

BIG money jobs in Foreign Employment for construction men, building trades, helpers, office men, others, interested in Foreign Projects. High wages, quarters, transportation. Listings of firms actively working on U. S., Foreign, Intercontinental Projects. Send \$1 for Foreign Construction Compendium and Application Forms. Foreign Service Bureau, Dept. S, Box 295, Metuchen, New Jersey.

MAKE money at home with Larson Leather-Craft. No experience needed. Easy-to-assemble belts, purses, gloves, etc. Send 10c for big Catalog of 100 ideas. Largest stock in U. S. J. C. Larson Co., 820 S. Tripp Ave., Dept. A76, Chicago 24.

\$2.00 WEEKLY Reported! No selling. Free booklet. T. J. Surface. Roanoke 4, Va.

MUSHROOMS Grown. Boxes, barrels, instructions 50c. Spawn \$1.00. Manureless process. \$2.00. Gordens, 328 Bannerman, Winnipeg, Manitoba.

START a buying service, buy wholesale thousands nationally advertised products. Make big profits selling at sizable discounts. Send postcard for details. American Buyers' Service, 631-T Linden, Buffalo, New York.

AMAZING Mail-Order Plan Free. Abbeon reports \$8,000 from Free Ads. Publicity. 1501C Trails-end, Kalamazoo, Michigan.

\$100-\$200 WEEKENDS. No selling or Manufacturing. Mahaffey, 3032-P Weldon, Los Angeles 65.

23 BOOKS & MAGAZINES

ILLUSTRATED Humor Library—Jokes, gags, after dinner stories, and more—24 pocket size booklets, \$1.00, with free fascinating catalog. Aladdin Book Co., 210-S Fifth Avenue, New York 10.

MAGAZINES (back dated)—foreign, domestic, arts, books, booklets, subscriptions, etc. Catalog 10c. (refunded). Cicerone's, 86-22 Northern Blvd., Jackson Heights, N. Y.

BOOKS—Booklets—Novelties. Illustrated comic booklets 20 \$1.00. Catalogues 10c. Kogan, 1032-PS Church Annex, New York 8.

CHARLIE Roy's Book Of Joy—Jokes, quotations. \$1.00 postpaid. Charles Edward Roy, P. O. Box 419-0, DeKalb, Illinois.

DISCOVERING Physics—Just published new and up to date. The story of physics, simply and clearly told for youth and adult. Special introductory offer—send \$5.00 and receive postpaid, 464 pages, over 400 unusual illustrations, 7 x 10, attractively bound. Your money back if you are disappointed. Addison-Wesley Press, Inc., Cambridge 42, Massachusetts.

MAGAZINE Subscriptions wholesale! Details upon request. Bedard Publications, Dept. PS, Box 637, Detroit 31, Michigan.

BOOKHUNTERS! Scarce, unusual, miscellaneous books supplied. Atlantic Book Service, 2 Lawrence, Charlestown 29, Mass.

ADULT Books—Illustrated Comic Book-lets, 10 for \$1.00, 24 for \$2.00. All Different. Free gift with each \$2.00 order. V. M. Rogers, Dept. PS, Box 14738, Cimarron Station, Los Angeles 18, Calif.

BOOKHUNTERS! All Subjects. Send Wants! Jaher Book Service, 620-K East 178 Street, New York 57.

FREE List Self-Unfoldment Books. "The Mysteries", Yoga, Occultism, Philosophy, Theosophy, Freemasonry, Jordan, 1130 Keller Avenue, Louisville 13, Kentucky.

WE serve libraries, dealers. Now individual service. The Magazine Barn, Dept. 1, Box 193, Seattle 11, Washington.

OUT Of Print Books. Send Wants! Book Finder, Cincinnati 30, Ohio.

ADULT Book Bargains. Send Stamp. Vallon, 63 Perry, New York 14, N. Y.

BACK-date Magazines. Specific issues; years. Arkell's, Tarzana 2, Calif.

24 GAMES & ENTERTAINMENT

QUIZ-Bingo, Globe-Rummy, Triple-Deal, Madam-X. Four complete games including Playing cards. \$1.00 postpaid, P.O. Box 842, Denver 1, Colorado.

PINBALL Games, Shuffleboards. Profitable. Webb Distributing, 4966 West Chicago Ave., Chicago 51, Illinois.

HYPNOTISM! Fascinating book, complete monolog, instructions. Only \$1.00. Hypnotism, 1978 Dartmouth Avenue, Columbus 3, Ohio.

25 MAGIC TRICKS, PUZZLES, ETC.

MAGICIANS' Gamblers' secrets ex-posed. Cards, Dice, Punchboards, Slot Machine. Catalog 10c. Book Co., Box 671, St. Louis 1, Mo.

"VENTRILLO," Professional Voice Thrower and Catalog 25c! Box 971-PS, Philadelphia.

LATEST Magic for pocket, parlor, stage. Catalogue 500 Tricks, only 10c. Unequaled magic service for 30 years. Douglas Magicland, Dept. 2, Dallas, Texas.

200 ELECTRIC stunts \$1.00. Cards \$1.00. Cutting Sons, Los Altos, Calif.

VENTRILOQUISM Self taught. Quick, easy instructions, 25c. "Ventriloquist", Cal Allen 3, Texas.

JOIN—National Guild Hypnotists. Details, Hypnodiscs, etc. 10c. Guild, 48B Harlem, Dorchester, Mass.

FREE trick and large illustrated catalog—35c. Lerro's Magic, 509 80th Street, Brooklyn 9, N. Y.

BE a Magician. Large professional magic catalog of latest tricks, 35c. Ireland, F-109 North Dearborn, Chicago.

512-PAGE catalogue of 2500 tricks, pocket, parlor, stage. World's Finest Magic. Send \$1.50 for catalogue (refunded first \$6.00 order). Kanter's, S-1311 Walnut, Philadelphia 7.

MAGICIAN'S illustrated catalog and free trick 35c. Terry's Magic Studio, 6606 Duryea Court, Brooklyn 19, New York.

FREE Trick with 1952 illustrated cata-logue 10c. Maj Magic Products, 23 Friends Lane, Westbury, New York.

26 COIN COLLECTING

GET Profit and Pleasure in collecting old coins. Send 10c for 56-page illustrated coin catalog. You'll be delighted with it. Send for it now. B. Max Mehl, 374 Mehl Building, Fort Worth, Texas. Largest rare coin establishment in U. S. Established 51 years.

OLD Money Wanted. Will pay Fifty Dollars for nickel of 1913 with Liberty Head (not Buffalo). We pay cash premiums for all rare coins. Send 4c for Large Coin Folder. May mean much profit to you. Numismatic Co., Dept. 30, Fort Worth, Tex.

FREE! Foreign coin, banknote and Coin Collectors' Illustrated Catalog to approval service applicants. Send 3c postage. Tatham Coin Co., Springfield-50, Mass.

FOREIGN money, two wooden nickels, and "Coin Collector's" new magazine, 10c. Lawrence Brothers, Anamosa, Iowa.

COMMEMORATIVE \$1/2—Columbus, Washington, Cleveland, Stone Mountain, \$2.00 ea. Illustrated Catalogue 25c. Norman Schultz, Salt Lake 9, Utah.

WE Pay \$5 to \$500 Each For hundreds odd-old U.S. & foreign coins. Keep all until posted. Send 20c for Ill's Coin Value Book 4x6 with bargain list free. 44 years in business. Coin Exchange-1, Le Roy, N. Y.

BARGAINS! Rare collection contains United States cent before 1815, 1851 cent, colonial coin before 1790, half cent, flying eagle cent, 1863 cent, 1865 cent, uncirculated 1909 VDB cent, 1923-S cent, 2c pieces, 3c silver, 3c nickel, half dimes, shield nickel, 1883 nickel, 1913 nickel, Liberty seated dimes, Columbus 50c, old \$1.00 bill, Civil War cent, Jackson cent, Confederate money, foreign coin, foreign bill, ancient coin 1500 years old, complete buying-selling catalogue everything \$5.00, 20 different Indian cents \$1.00, 10 different Liberty nickels \$1.00, 10 different large cents \$2.00, 1864 L cent \$2, Everything \$10.00, catalogue 25c. Worthycoin Corporation (D-410) Boston 8, Massachusetts.

27 OLD STAMPS WANTED

I WILL Pay \$100.00 each for 1924 1c green Franklin stamps rotary perforated eleven (up to \$1000.00 each unused). Send 10c for Large illustrated folders showing Amazing prices paid for old stamps, coins & collections. Vernon Baker, PS-21, Elyria, Ohio.

28 STAMP COLLECTING

200 DIFFERENT, including Roosevelt triangle, 5c to approval applicants. S. Avalon Stamp Co., Springfield, Mass.

AMAZING Offer! 500 United States stamps—including commemoratives, airmails, high values to \$5.00—Only 10c to Approval Applicants!! Illustrated Bargain Lists free. Mystic Stamp Co., Dept. 55, Camden, New York.

COLUMBIANS, Trans-Mississippi, Pan-Americans, Pan-Pacific, ten other different commemoratives. All 10c with your request for US approvals. Moda Stamps, Box 251-V, C.S.A., New York 8.

WOW! 203 All Different Germany 10c! Zeppelins, Semipostals, Airmails, High Values, etc. to new customers. Jamestown Stamp, Jamestown 509, New York.

FREE—Complete set of Famous Ameri-cans, Flags, Parks and Presidentials to approval buyers. Send 3c for 15 of the above stamps plus full particulars. Triboro Stamp Company, 145 Nassau Street, Dept. 201, New York 38, N. Y.

U. S. COLLECTORS—write today for free material. Eagle Stamp Co., 2221-B Romine, Pittsburgh 26, Pa.

750 FRANCE and colonies stamps 10c. Littleton Stamp Co., Littleton 26, N. H.

500 STAMPS For Only 10c! This mam-moth value includes Airmails, Pictorials; stamps from strange countries cataloguing up to 25c each!! Also approvals. Mystic Stamp Company, Camden 55, New York.

FREE! Powerful Magnifying Glass. Jamestown Stamp, Jamestown 202, N. Y.

77 DIFFERENT United States—25c. Approvals, Utechts, 1143-A North Keeler, Chicago 51.

300 DIFFERENT given free with ap-provals. Postage 3c. Windsor Stamps, 1435 E. 67th Place, Chicago 37.

1050 DIFFERENT Stamps given to ap-proval applicants becoming customers. Send 3c for particulars, lists and approvals. Bryson Stamp Company, Drawer F-30, Rossford, Ohio.

ROOSEVELTS complete, plus 25 other U. S., 10c with United States approvals. Locust, Box 305-A, Harmon-on-Hudson, New York.

POLAR Bear Triangle; Giant George Washington Six Colored Ecuador, Arctic Triangle, first American commemorative, Corsica, Devils Island, others. Everything free with approvals. Capital Stamps, Little Rock 10, Ark.

FREE, Scott's International Album. Other big premiums. Full particulars with approvals. Raymax, 123-X William St., New York City 38.

312 MIXED U.S. only 10c to "Gold Nug-get" approval applicants! Nothing like them. Kessel's Folsom, Calif.

FREE! "What's My Name?" Fascinat-ing Illustrated quiz booklet. Barrels of fun for everyone; Valuable prizes for correct answers. This Booklet absolutely Free! Send to-day. Approvals! Stamp Quiz, Calais, 618, Maine.

LOOKING for better U. S. on approval? Write: New-Way Stamp, Lawrence, Mass.

GIANT Selection, penny stamps. Wahl's Stamp Exchange, 7008K Farragut, Chicago 31.

WE Give Away—Your Choice Latest Scotts Albums; Catalogue and available philatelic accessories. Realize—You Get These Worthwhile Rewards When You Buy From Our Better Foreign Approvals. Write Today For Full Particulars Sent With Trial Approval Selection. Americas' Stamp Service, Riverside 2, Calif.

FREE! Tiny Chinese "Midget" War set. Approvals. Seminole, North Miami, Fla.

MINT (Unused) U. S. approvals. Patrick Agencies, 3650C Central, Indianapolis 5, Ind.

PAYING High Prices For Approvals? If your collection numbers under 15,000 try our 1c and 2c approvals. In books of 1,000 different. Lots to choose from at lowest prices. Also special offer to customers. Clark, Box 544U1, Muskegon, Mich.

ARE You Satisfied? If not, write us to-day. Ask for 1c and 2c foreign approvals. U.S. bargain prices. References appreciated. Roseland Stamp Co., Dept. 9-B, Spring Lake, Mich.

POPULAR SCIENCE OPPORTUNITIES

SCARCE Nicaragua, Roosevelt, Madagascar, Turkey, Martinique, Ecuador, Somali Coast, Cuba, Mints. Send 3c. Silas Stamps, Box 55-V, Triborough, New York 35, New York.

FREE—Belgium complete set of 17 stamps to approval applicants. (We pay return postage). Frank Newman, 3539 Hartford St., St. Louis 18, Missouri.

FREE! 25 different Switzerland with swell approvals. Kardel, 209 Bower, Santa Fe, New Mexico.

FREE 1620 Stamps free to approval buyers. Bacon, Huntsville, Missouri.

MAGNIFICENT! Nineteenth Century U. S. Plus Civil And Spanish War Revenues, 20 Different 10c To Approval Applicants. AAA Stamp Company, Arcade Building, St. Louis 1, Missouri.

NUDE Duchess (Spain)—Eighteen values complete in collection of 1,020 different stamps—Everything \$1.00! With approvals. Stampex, 116-SP Nassau Street, N. Y. C.

U. S. Specialists! Stamps—Coins—Write—210 So. 6th Street, Minneapolis.

FREE! Big United States Catalog! Invaluable guide and check list. Hundreds of illustrations. Harris & Co., Boston 17-B, Massachusetts.

FREE: Mint British Colonies from Niue, Gilbert Ellice, Nauru, Turks Caicos, Brunei, Caymans, Tonga, Pitcairns, Sarawak—Free with approvals. Viking, 130-P Clinton St., Brooklyn, New York.

FIRST U. S. (1847) Government Reissues 5c, 10c, plus Giant Bargain U. S. Collection—only 5c to applicants U. S. approvals. Metropolitan, Box 312K, Jackson Heights, N. Y.

FREE "Stamp Finder." Tells instantly country to which any stamp belongs. 32 pages profusely illustrated. Garcelon, Calais 18, Maine.

UNITED States stamps nearly 100 years old. Roosevelt set, others, 40c value—only 6c to applicants United States approvals. Wakonda, Box 272-H, Jackson Heights, N. Y.

FREE Stamp Collection:—100 different stamps from Europe, Africa, Asia, Scandinavia, Balkans, etc., 3c to approval applicants. Tatham Stamp Co., Springfield 50, Massachusetts.

FREE—Illustrated Catalog! Kenmore, Richford C-58, Vermont.

205 AUSTRIA—All Different only 10c. Beautiful Commemoratives, Pictorials, Airmails, High Values. Catalog price nearly \$6.00! Approvals. Garcelon, Calais 112, Me.

FREE! 3 Monaco Nudes, to new approval applicants. M. Moulblow, 740 Hegney, Bronx 56, New York.

4 GERMANY Fair Sets. Free to approval buyers. Pleasure Stamps, 1865A—52nd, Brooklyn 4, New York.

PENNY Approvals by country. M. H. Hoerning, 102, Farmington, Ark.

OLD scarce U. S. seconds on approval. Slightly defective, bargain prices. Hearnfeld, Clintonhill Station, Newark 8, N. J.

MINT Army Navy set 50c. Twelve Mint Commemoratives 50c. Complimentary to Approval Customers, Charles McKeel, 2101 East Market, York, Penna.

100 DIFFERENT Sweden 25c. Approvals. Gronberg, Box 5441-S, Phila. 43, Pa.

100 NETHERLANDS, all different. Beautiful assortment, 10c with approvals. Thomson's, Box 4074-S, Miami, Florida.

50,000 STAMP Grabags 25c each. Anderson, 630a Bingham, Reading, Pa.

"HOW To Recognize Rare Stamps." Free Book Illustrated! Kenmore, Richford H-58, Vermont.

50 DIFFERENT U. S. 10c. No Approvals. Seidenberg, 944, Appleton, Wis.

FREE! Big illustrated catalog! "Everything for the stamp collector." Harrisco, 204 Transit Bldg., Boston 17, Mass.

307 ALL Different—Only 15c! Beautiful collection: Commemoratives, Triangles, High Values, Bicolored Stamps, etc. Garcelon, Calais 418, Maine.

500 EKOTIC Japan Stamps—10c! Kenmore, Richford J-58, Vermont.

ZOUNDS!! Amazing "Queer Countries," Savage and Exotic Lands Packet—Absolutely free with approvals! Saxon, Vista, California.

NICARAGUA Sports, Costa Rica Agriculture sets 10c with approvals. Seminole Stamps, Box 1138, Coral Gables 34, Fla.

ZANZIBAR Packet Free—Also includes stamps from Abyssinia—Cayman Islands—Ceylon—French Colonies—Gambia—Malta—Nigeria—and others. Send 5c for postage. Gray Stamp Company, Dept. PR, Toronto 5, Canada.

PENNY Approvals! Also advanced material. Sunnyco, 1267 Tutwiler, Memphis 7, Tennessee.

LOOK \$50.00 catalogue \$2.50. 2,000 stamps. Hale, 7609 Grand, Minneapolis, Minnesota.

WONDERFUL Offer 7 complete mint sets Manchukuo, Bohemia, etc. only 10c, with approvals. Reich Stamp Co., 4647 Kenmore, Chicago 40, Ill., Dept. S23.

1/2c—1c APPROVALS! Bargains galore! Cole, 43-g Rinewalt, Buffalo 21, N. Y.

PICTORIALS! Commemoratives! Inexpensive bonus Approvals. Linton, 38 Barton, Toronto 4, Canada.

289 DIFFERENT Foreign stamps 10c with approvals. Hoyt, Lowell Road, Hudson, New Hampshire.

CLUB Journal, \$1.50 yearly. Herold, Dept. PS, 4209 77 Street, Elmhurst, N. Y.

FREE Album! Commemoratives!—to buyers from our famous penny approvals. Complete details accompany trial selection. Orana, Box 1775, Santa Ana 22, Calif.

NUDES Set and colorful approvals—10c! Atlas, 2830-p Eisenhower, Racine, Wisc.

FREE Sample—Interesting, Informative. Illustrated National Stamp News, Anderson 2, South Carolina.

10,000 DIFFERENT 1c each! Gordon Davison, Box 1019, Manchester, N. H.

FLAG Stamp—Free with hygrade U. S. approvals. Weniggman's, 1933 Patterson, Chicago 13.

ALBUM! Holds 2000 stamps! Only 10c! Glamore Company, Manchester 1, Conn.

U.S. 797 SPA Sheet only 5c to applicants for U. S. approvals. M. Haycock, 235 86th St., Brooklyn, N. Y.

SWITZERLAND—50 different 10c! No approvals. Erie, Box 2642, Lakewood, Ohio.

TRIANGLES—5 Different, 5c with Approvals! Stearns, 1249-C Griswold, Detroit 26, Michigan.

IRON Curtain Countries! Hitler! Boy king! William Tell! Castles! Inflation! Beautiful mint sets!—527 different and approvals, just 25c! Niagara Stamp Company, 24 Queensway, Niagara-on-the-Lake, Canada.

CANADA scarce 1950 set 10c with attractive approvals. Rheume, 6591 11th Avenue, Montreal, Canada.

100 DIFFERENT U. S. 25c. Approvals. Buckeye, Box 53, Mansfield, Ohio.

FREE Collection—over 100 different stamps of world—commemoratives, animals, natives, ships, famous men, others all to approval buyers; also Scott Albums, Catalogs, Bell Stamp Service, Dept. W-3, Bell, California.

FREE! Big illustrated catalog! Send Today! "Stamps By Mail," 2133 Lunt, Chicago 45.

PENNY Approvals—many Countries. Cs. Reitter, Box 1505, Detroit 31, Michigan.

FREE U. S., Confederate States illustrated catalogue for stamps, albums, supplies. Stone, 45 Bromfield, Boston 8, Mass.

1000 MIXED U. S. and foreign 25c. Monjar, Fairmount, Cincinnati 14, Ohio.

VALUABLE gift to applicants Personalized Approvals, British Colonies—Latin America. Lawrence Kittinger, Winter Park, Florida.

FREE! 750 Mixed U. S. for Dime Postage. Weatherby, Medina, Ohio.

CHRISTMAS Day Cachet cancelled December 25th at Christmas, Florida. Free to applicants of U. S. or British Colonial approvals. Alan Taylor, Box 735, Winter Park, Florida.

PENNY approvals by countries. Also net. Miracle Stamps, Miracle Hot Springs 3, Calif.

START your own Stamp Business. Send for Free circular. Donald Shepard, Box 1147, Chicago.

FREE—"Goya Nude" with approvals. References. Royal Stamp Company, Tamagua 2, Pa.

SPORTS—pictorials—5 sets only 5c. Approvals. Wirth, Norwichtown 1, Conn.

29 ANTIQUES, RELICS & INDIAN GOODS

1952 COLLECTORS Catalog.—Selling 20,000 Indian Relics, Collectors Cartridges, Coins, Confederate Money, 450 Historical Firearms, Revolutionary, Civilwar, Indian Wars Flintlocks, Muskets, Blunderbusses, Percussion Caps, Kentucky Rifles, Pepperboxes, Pistols, Revolvers, Ramrods.—Arrowheads, Gempoints, Spearheads, Discoidals, Bannerstones.—Steerhorns, Elk Antlers, Blo-horns, Bo-wood, Violin Wood, Winchester, Duelling Pistols, Buffalohorns, Gold Dollars, Carbines.—Mounted Pheasants, Owls, Squirrels.—Agates, Fossils, Minerals, Daguerreotypes, Ambrotypes.—Live Pheasants. Send 35c for 1952 profusely illustrated catalog.—Heike, Wenona 42, Illinois.

4 FINE ancient Indian arrowheads \$1.00. Fine stone tomahawks \$2.00, \$3.00. List free. Lear's, Glenwood, Arkansas.

SPECIAL:—10 Indianheads 68c—5 Arrowheads \$1.23—Tomahawk \$3.88—Battleaxe \$3.80—Hammerstone \$1.78—Civilwar Musket \$28.50—Sword \$8.88—Bayonet \$1.98—Powderhorn \$9.48—Ramrod \$1.65—Scalping Knife \$1.88—Agate, Pyrite, Molybdenum, Fossil, Geode, Gempoint, Blastoid, Crinoidstem, each 48c.—Live Pheasants \$3.88 each, pair \$6.80. Heike, Wenona 42, Ill.

30 MINERALS & PRECIOUS STONES

"GENUINE" red Arizona Rubies (Garnets). Send quarter for packet. Bitner's, Box 1025-C, Scottsdale, Arizona.

FIND Tungsten, mercury, uranium with Mineralight. Free brochure. Write Dept. PS8, Ultra-Violet Products, South Pasadena, California.

GEMCUTTING, Silvercraft authority. Illustrated magazine tells how. Cut rocks, make jewelry. 150 ads illustrating equipment, offering gems for collectors, cutters. Postal brings literature. Lapidary Journal, Drawer D, Palm Desert, Calif.

GEMS, Precious and semi-precious, genuine, from world-wide sources. Deal Direct, no overhead, save money. Catalog 10c. Hill Co., 5450-K Portland Rd., Salem, Ore.

GEMSTONES, Mineral specimens. Every variety. Lowest prices. Postcard brings free booklet. Plummer's, 2183D Bacon, San Diego 7, Calif.

FINISH beautiful gems by hand. Easy. Kit including two shaped gems, supplies, instructions. \$2.00. O'Briens, 1116 N. Wilcox, Hollywood 38, Calif.

AGATES, Jade, Gems, free list. North West Gem Shop, Box 305, Tacoma 1, Wash.

FIVE mineral specimens, also magnetite with magnet, two dollars. Bowman's Mineral House, Elk Park, North Carolina.

31 HOBBIES, COLLECTIONS

INVENTING can be an interesting and profitable hobby. Write for complete particulars. Institute of American Inventors, Dept. 30-E, 631-E St., N. W., Washington 6, D.C.

50 DIFFERENT army embroidered patches \$1. Other bargains. Insignia Mart, 703B Broadway, N. Y. C. 3.

COLLECT Cartophilic Cards! New fascinating hobby—Interesting packet containing Birds—Butterflies—Aeroplanes—Flowers—Trains—and other rare cards—Plus big illustrated catalogue—All for 10c. International Cartophilic Co., Dept. PS, 1152 Yonge Street, Toronto, Ontario.

WANTED Cigarette, tobacco, cards. Write Charles Bray, East Bangor, Penna.

UNUSED matchbook covers—100 different \$1.00—36 page Catalog 25c—Charles Edelman, 1311P East 84, Cleveland 3, Ohio.

32 PHOTO FINISHING, PHOTOCOPIES, ETC.

OUTDOOR pictures, glossy, the kind you like. 7—\$1 cash. WMSPS, 500 Charlotte, Grand Rapids, Mich.

POPULAR SCIENCE OPPORTUNITIES

24 GLOSSY photos \$1.00. (6 sets 144 photos \$5.00). Beautiful models, all different, glamorous poses, the kind you will like. Catalog 50c. none free. Nutrix Co., Dept. D-51, 212 East 14th St., New York 3, N. Y.

OIL coloring photographs can be a fascinating hobby or profitable sideline for those with artistic talent. Learn at home. Easy simplified method. Send for free booklet. National Photo Coloring School, 835 Diversey Parkway, Dept. 1741, Chicago 14, Illinois.

ROLL Developed and 4x6 or 3 1/4 x 4 1/2 oversize glossy Velox prints, 8 exposure 40c, 12 exposure 60c, 16 exposure 80c. Clemet Photo Service, 1318 West Columbia Avenue, Philadelphia 22, Pa.

FILMS, highest quality, rapid service, eight enlarged prints, 50c. "Camera," Box #280, West Chester, Penna.

JUMBO Album Prints, 8 Exposures \$4.00, 12—\$5.00, 16—\$6.00. Photoshop, Box 362, Ishpeming, Michigan.

8 CONTACTS 30c, jumbos—40c, 12—45c, Jumbos—55c, reprints—4c, jumbos—5c. Free mailers. Western Photo PS152, Box 298, San Francisco 1, Calif.

FREE Coupon, Price list on enlargements, etc. Dornfeld, Ironridge 15, Wisc.

FINEST quality enlargements, 5x7 30c, 8x10 50c, 11x14 85c, 10c mailing charge. Supreme Photo Service, Box 127, Beaver City, Nebraska.

24 PICTURES from your 8 Exposure Roll, if you don't spoil any. If you do, we will print you three of each of the good ones for 50c; two each 40c; one each 30c; reprints 3c. L. A. Eastman, Bode, Iowa.

PHOTOCOPY Anything—Papers, books, No darkroom, 8 1/2"x11" complete \$6.95. Fotofek, 8555 Plainfield Lane, Cincinnati 35, O.

33 MOTION PICTURES, SLIDES SOUND EQUIPMENT

GUARANTEED Fresh 8mm roll, magazine; 16mm roll, magazine movie film. Color, b&w. Free catalog. Eso-S, 47th Holly, Kansas City 2, Missouri.

UNUSUAL 8-16MM. Movies, Full-color projection length sample, \$1.00. Color Tru-Art Slides, three samples \$1.00. Big catalog, 25c (refundable). National Film Supply, Toledo 9-E, Ohio.

MOVIE Camera Film: 8mm roll \$1.50, 16mm 100' \$3.00. Free processing. Better Films, 742 New Lots, Brooklyn, N. Y.

LATEST Beauty Glamour Films, Sample, 8mm 50 ft. only \$3.75, 25c brings exclusive catalog of movie titles. Empire, Dept. PS-1, Box 23, White Plains, N. Y.

121 KODACHROME movie subjects. National parks, war, western, atom bomb. Big catalog, 3c. Sample, \$1.00. Specify 8mm-16mm, World In Color, Box 392, Elmira, New York.

1952 ROSE Parade Movies, Kodachrome, Colorful floats! Beautiful girls! 16mm 200' \$34.95, 8mm 100' \$17.50. C.O.D.'s accepted. California add tax. Avalon Daggett, 441 North Orange Drive, Los Angeles 36, Calif.

ALMOST free—with Blackhawk's big 28-page film bargain catalog—one brand new film (our selection) postpaid; 100' 16mm sound, 98c; or 100' 16mm silent, 59c; or 150' 8mm, 99c—as special get-acquainted offer. Typical Blackhawk bargains: New 1-reel 16mm sound films, \$7.95 (formerly \$19.75); new 1-reel 16mm silents, \$2.19 (formerly \$9.75); new 1-reel 8mm \$1.19 (formerly \$5.50). Used Panoram 100' 16mm musicals, \$9.98 per dozen. Similar bargains in used films of all types. Used sound projectors—Ampros, Bell & Howells, Victors—often available low as \$129.95. Write today for Blackhawk's free catalog. Blackhawk Film Inc., "Sixteen's Super Market," 1106 Putnam Bldg., Davenport, Iowa.

THE World's Greatest Story, "Entire Life of Christ" 8mm, 16mm, Sound & Silent. Rent or Purchase. Hemenway Film, 33-W Melrose Street, Boston 16, Mass.

5,000 NEW-Used 8-16mm. Silent-Sound Films. International, 2120 Strauss, Brooklyn 12, New York.

RENT 16MM sound films 50c reel. Large selection; free catalog. U. C. Film Service, 128 Chestnut St., Roselle Park, N. J.

ART Film, Slides, Free list, Samples \$1.00. Price Brothers, 64-C West Randolph, Chicago.

8-16MM. Silent-sound films. Complete rental library. All latest subjects. Free catalogue, (sample film 10c). Garden Film, 317 West 50th, New York 19.

HOLLYWOOD Models, Sample Reel 50 ft, 8mm \$3.25, 100 ft, 16mm \$5.50. Free Catalogue, Fine Arts Film Co., U. O. Box 2084, San Antonio 6, Texas.

HOLLYWOOD Titles will tell your story, 8mm, 16mm. Send 10c for rates and samples. Hollywood Title Studio, 1060 North Vista Street, Hollywood 46, Calif.

34 CAMERAS, PHOTO SUPPLIES

FREE Photographic Bargain Book packed with hundreds of sensational values in still and movie cameras, lenses and latest accessories. Super savings for you in new and used equipment. Liberal trade-in allowances, too, on your equipment. Write now for your free copy to Central Camera Company, Dept. 2-M, 230 S. Wabash Ave., Chicago 4 (Photographic Headquarters Since 1899).

BASS Says: Trading cameras a national habit since 1910. Write to Bass the old "Horse Trader." A postcard will do. Simply say: "Bass, I have and I want... How much will you allow me?" Satisfaction guaranteed. Bass Camera Company, Dept. AG, 179 W. Madison St., Chicago 2.

ADD "Spice" to home projection shows with colorful old-time Nickelodeon slides, 2x2. Write for Free list, Nickelodeon Co., New Fleidner Bldg., Portland 5, Oregon.

KINE Exakta VX, latest 1952 model, f2.8 tessar, case, never used, \$204.90. Free catalogue, 1001 bargains. Dealer's Mart, Dept. SD, 11 Willard Avenue, Mt. Vernon, N. Y.

PLASTI-Tak, the revolutionary re-usable adhesive for making borderless enlargements, mounting snapshots etc. 25c postpaid. Chelsie Company, Box 35-A, Cincinnati 24, Ohio.

FREE Instructions, 300 power telephoto camera easily made. Trifling Cost, Telescopic Camera Co., Manorville 5, N. Y.

WANTED Used Bell and Howell 16mm and 35mm Cameras. P. O. Box 508, Canoga Park, Calif.

PHOTOMURALS. Your negative or ours. Catalogue 25c. Photomammoth Murals, Dept. S, 12048 Vanowen Street, North Hollywood, Calif.

100-WATT Slide Projector only \$6.00 postpaid. Factory sale, discontinued model. Guaranteed, VuAid Inc., Ann Arbor, Mich.

35 MUSIC, INSTRUMENTS & SONG WRITERS

POEMS Wanted to be set to music. Free examination. Send poems, McNeil, Master of Music, 510-PS, S. Alexandria, Los Angeles, California.

WANTED! Poems for musical settings. Write Songwriters' Service, Clifton, N. J.

POEMS Wanted for musical setting. Send poems for free examination. Five Star Music Masters, 646 Beacon Bldg., Boston, Mass.

POEMS Wanted, Broadcast consideration. Sooner Song Co., 22 Northwest 8th, Oklahoma City 2.

SONGWRITERS! Send poems, songs. Music Service, 243 West 72nd St., PS, New York 23.

MUSIC Printing, for Samples, Rates, Write Auto-Litho, Jensen Beach 2, Fla.

ELECTRIC guitars, amplifiers, wholesale. Free catalog, Carvin, PS, Baldwin Park, Calif.

SONGWRITERS! Outstanding, ethical offer. Hibbeler, C-15, 2157 N. Avers, Chicago 47.

SONGWRITERS! This is the Thing!! Free information. Trans-World Music Co., 6356 Hollywood Boulevard, Suite 230-4, Hollywood 28, Calif.

REAL Composer of music will co-operate with Lyric Writers in song production. Fine publication proposition. Recordings by fine artists on Nationally Advertised label. Record, recent release \$1.00 pre-paid. C. Isabel Mayer, Box 3896, Portland 8, Oregon.

GUITARS—Accordions—Clarinet—etc. Terms. (Specify Instrument), Ribner's, 74 Ferncroft Rd., Milton 87, Mass.

36 RADIO, TELEVISION, SUPPLIES & EQUIPMENT

FREE! 212 Page Radio-Television-Electronic Catalog! World's largest stocks, lowest prices. Complete supplies for builders, experimenters, amateurs, servicemen. Latest radios, phonos, television, recorders, sound equipment. Thousands of parts, tubes, test instruments, books, diagrams. Top quality money saving values. Get yours now! Allied Radio Corp., 833 W. Jackson Blvd., Dept. 34-A, Chicago 7, Ill.

MAKE simple, tubeless, batteryless, distance-getting crystal radios. Crystal and illustrated instructions 25c postpaid. Allen, 427-S, Clinton, Mo.

AMATEURS—Radio Engineering Questions answered \$1.00, with schematics \$2.50. Henry Twillmann, Route #1, Chesterfield, Missouri.

BUILDER'S "Pictorial Construction Plans". Free List, Alena, Box 24, Astoria 6, New York.

CRYSTAL Radio for \$1.75, Leslie Hulet, R. 2, Lakewood, New Jersey.

24 PAGE Plans "18 Crystal Sets" (SW record 5800 miles) 25c, including "Radio-builder," catalog. Laboratories, 1131-T Valota, Redwood City, Calif.

MAKE Distance-Getting crystal radio that works. Fully illustrated booklet fifteen cents. Money back guarantee. Francis, Box 5963, Cleveland, Ohio.

BUILD, repair radios, televisions, experience unnecessary. Start working immediately. Parts, tools, practical course. Fifteen dollars. Make good living. Free literature. Steg Electronics, Colchester, Conn.

37 BUSINESS OPPORTUNITIES

GOOD Paying Business Silvering mirrors, plating autoparts, reflectors, bicycles, bathroom fixtures, etc., by late methods. No tanks or shop required, outfit furnished. Free Booklet. Gunmetal Co., Ave. E, Decatur, Illinois.

ENVELOPES addressed accurately, reasonably. Fast Service. We have capable addressers in your city. Glenway System, 5713-X Euclid, Cleveland 3, Ohio.

OPERATE profitable mail order business. Write Walter Service, 4159-B East 112th, Cleveland 5, Ohio.

FABULOUS Earnings—Fascinating pastime. Growing Genuine, living miniature (Ming) Trees. New sensational Business or Hobby. Astounding information Free. Dwarf Gardens, Box 355H, Briggs Station, Los Angeles 48, Calif.

BIG money! Spare or full time in your home. No Selling! Spray New Miracle Finishes. Plush and Suede, on signs, radios, automobiles, figurines, lamps, toys, etc. Our business is booming. Help us fill huge demand. New easy Flok-Kraft methods. Material costs few pennies. You get dollars. Free samples, complete powerful money making plan free. Write now. Coast, 1002-A, Los Angeles St., Los Angeles 15.

RECAST old batteries into new. Latest achievements. Battery Laboratories, Minneapolis.

TRAVEL Anywhere, Anytime. Earn \$50 up a week. Free details. Travel, La Grange 22, Indiana.

VENDING Machines earn big money! An investment as low as \$10.50 will start you in this fascinating, profitable business that can lead you to the road of success and independence. Routes can be established and operated in either full or spare time with no experience needed. Write for full details and our Free catalog illustrating our nut, candy, gum and stamp vendors; also pin ball machines, music boxes, etc. Write immediately to: Parkway Machine Corporation, Dept. 9, 715 Ensor Street, Baltimore 2, Maryland.

SELL by mail; free details; instructive booklet 25c. Manhattan House, Box 51-L, St. Albans 12, New York.

\$25 WEEKLY Working two hours daily. No canvassing. No manufacturing. Lycke, Box 2471-B, Cleveland 12, Ohio.

POPULAR SCIENCE OPPORTUNITIES

MAKE money addressing envelopes. Our instructions reveal how. Glen Glenway, 5713 Euclid, Cleveland 3, Ohio.

EXTRA Money—No Selling—operate vendors. Amazing profits, details Free. Silver King, Suite 221, 622 Diversey, Chicago 14.

PROFITABLE Home Mfg. Business. Make waterless hand cleaners, household & auto specialties, etc., by simply adding water to basic concentrates. Over 300% profit, up to \$500 monthly, on steady repeat orders. Formulas free Western G Aircraft, Los Angeles 19.

BIG Money and fun growing Live Miniature Ming Trees on you window sill. Write for Free rare tree seed and plan, National Nurseries, 8620B Ruthelen, Los Angeles 47, Calif.

LEARN Sewing Machine Repair. Electrify, rent, trade, sell. Make "Big Money" at home, spare time. New motors, machines, etc., wholesale. Details free. Taylor Service Co., Hamilton PS-1, Ohio.

CONVERT hand mowers to power mowers. Do it now, this winter. Sell the Handy-Dandy conversion kits. Easily installed on 16 to 20" mower. Use any small gasoline or electric motor. Quick delivery. Kits purchased with or without engines. Also new Garden Cultivator. Cultivates 3" deep. Attachments available: weed cutter, lawn mower and snow plow. Discount to dealers. LeClaire Manufacturing Company, Dept. PS, LeClaire, Iowa.

IMPORT-Export! Men-Women. Instructions from established World Trader shipped for no-risk examination. Opportunity profitable world-wide mail-order business from home without capital; or travel abroad. Experience unnecessary. Free details. Mellinger, 1715-AJ, Los Angeles 24.

START Mailorder Bookshop—Everything furnished. 25c brings booklet, samples, exciting ideas. General Publications, Ossining 1, New York.

TO \$35.00 Weekly. Spare Time. Home Operated Mail Order Business. Successful small "beginner's" plan. Everything Supplied. Lynn, 5710-C Bankfield, Culver City, California.

BOOKKEEPERS—Operate profitable "No-Ledger" bookkeeping service. Write Frye, Box 432, Chester, South Carolina.

INVISIBLE Reweaving. Men-Women. Instructions shipped for no-risk examination. \$5.00 hour possible spare-full time. Reweave burns, tears, moth-holes like new at home. Free details. Skilweave, 1717-FD Westwood, Los Angeles 24.

EARN Extra Money weekly mailing circulars for advertisers. Complete instructions—25c. Siwaslian, 4317-B Gleane Street, Elmhurst 73, New York.

START your own Mail Order Business with hundreds of live repeat hobbycraft items. No stock to carry. We pack and ship for you. Free Details. Write Dept. B1, Mail Order Service, 845 S. Wabash, Chicago 5, Illinois.

MAKE Money At Home as renewal headquarters for all magazines. Liberal commissions. No experience—No capital needed. Supplies furnished. Write for Free Catalog. McGregor Magazine Agency, Dept. 510B, Mount Morris, Ill.

TIRED Of No Money, second rate jobs? Like to start a real career with a lifetime of high salaries? Write me about two growing fields that really need men. Ed. Howes, Chief, 456 W. Santa Barbara Avenue, Los Angeles 37.

START a Venetian Blind Laundry. Profit opportunity for lifetime business. New machine method. Free booklet on request. F. D. Co., 442 N. Seneca, Wichita 12, Kansas.

AMAZING New Patented labor-saving, precision screw-holding screw drivers! Removes, inserts, holds screws hard-to-get-at places! Tremendous profits; stores, factories, plants, shops, city, state. Gov't Dep'ts. buy quantities. Exclusive state distributors. Toolco, 90 Summit, Brookline, Massachusetts.

EXPORT-Import! Represent manufacturers! Conduct barter exchange. War-peace time big profit business. Buy sell by mail. International Trades, 246-S Fifth Ave., New York 1.

COLORGLAZED Concrete Pottery made without molds. Patented method. Cemetery products, novelties, tiles. Basement leak-sealing. Money-making projects. Booklet, details free. Men only. National Potteries, Grand Rapids, "Minnesota."

HOW and where to obtain Capital? Free details. Star Service, Wapakoneta, Ohio.

POPCORN Equipment. Potato Chip Outfits. Long Eakins Company, 5263 High, Springfield 99, Ohio.

\$10 HOUR. easy; home-grinding armfuls hand and circle saws, half price. New way. No competition. Bags scissors, knives; hedgers, mowers, axes. Machine (30") furnished. Hurry! Inventor, 3503-6 Chestnut, Balt. 11, Maryland.

\$35. WEEKLY! Home! Two hours daily! Invisible Reweaving, 17 samples, 48 lessons, automatic latch steel tool assembly, material for life \$3, complete. (27 other unusual home projects) Guaranteed. Details free. Walsh, 394 Main, Buffalo 2, N.Y.

HAND, circle saws hook ground new way, #.50. Hurry postal now. Inventor, 3503-6 Chestnut, Baltimore 11, Md.

MAKE Perfumes At Home. Write, "Carey Laboratories," 1914 Chouteau PS-1, St. Louis 3, Missouri.

BOOKKEEPERS boost income operating franchise bookkeeping service. Kern, 4942A Vineland, No. Hollywood, Calif.

FISHWORM Business—Raise and sell Fishworms. Big demand, large profit. This booklet, "Raising Worms For Pleasure or Profit," gives complete details. \$1.00 postpaid. Tennessee Worm Hatchery, Box 265-A5, Nashville 2, Tennessee.

LIQUID Rubber, make flexible molds. Free Sample. Chaney, 1130 E. 16th St., Jacksonville 6, Fla.

MAKE Big Money at home with Magic Pearl Finish. Free plan. Pearl-Art, 7216 Bear, Bell, Calif.

NEW Exceptionally Profitable, plans, ideas for home operated mail business. Rush name. Miller, 1772-R Carlyon Road, East Cleveland 12, Ohio.

WHY Job Worry? Start Electroplating. Metal Finishing Business. Free Information, trade secrets. Plater S. Hyde, 327 West 120th Street, Los Angeles 61, Calif.

ESTABLISH profitable automatic shoe shine route. Proven. Write Jiffy Shine, 1630 South Second Street, Phila. 48, Penna.

BRONZED Baby Shoe metallizing equipment. New and used. Big selection of metal and onyx mountings. Free instructions. Hollywood Bronze Supply, Dept. P, 1624 E. First Street, Los Angeles 33, California.

MAKE money at home, painting beautiful wall plaques. Sample assortment of 10 best sellers, \$30.00 retail value, for \$7.50 . . . \$5.00 with order, balance C.O.D. Trading Post, Stoystown, Pa.

FIGURINES unpainted, free illustrated list. Havery Products, 822-A 17th Street, Altoona, Penna.

PUBLISH home Magazine. Sample copy Fair Monthly, imprints, details, 10c. Arthur S. Whelpley, Pine Bush, N. Y.

MAKE flexible molds! Cast plaques, bookends, figurines! Free sample! H. Tooker, 630-A Chestnut, Hamilton, Ohio.

QUICK Sign Painting. Use letter patterns avoid sloppy work, wasted time. Write for sample. John Rahn, B-1330 Central, Chicago 51.

OPERATE Profitable Mailorder Business. Particulars Free. George Lenhoff, Lincoln 1, Nebraska.

"HOW To Build Financial Independence!" \$1.00 postpaid. R. D. Harrison, Box 247, Dermott, Arkansas.

TRADE Magazines Help You to success. Get latest copies through our Easy-to-Get-Acquainted Service. Hundreds of business, professional, craft, advertising, agricultural, amusement, architecture, art, astronomy, athletic, automotive, aviation, baking, banking, barber, beauty shop, beverage, and book, brick, building management and others covering All interests. Send for List today. It's Free. Commercial Engraving Publishing Company, 34S North Ritter, Indianapolis 19, Indiana.

MOLDING Rubber, \$2.95 qt., \$9.95 gal. prepaid. Plastercraft Supply Co., 3051 St. Clair Ave., Cleveland 14, Ohio.

WANTED! At Once! Home Producers by manufacturers in our Clearing House Service. Become a sub-contractor casting plastic products for these companies. Thousands of easy to make items required. Cash in at home, without previous experience. For details write Plastic Service Guild, Dept. PS, East Boston 28, Mass.

OPERATE profitable mail order business. Splendid Opportunity. For details write W. Bitterman Productives, 133-B Boren North, Seattle 9, Washington.

FREE Illustrated course casting novelties genuine latex for molds. Major Chemical and Latex Co., 25 Allerton Street, Boston 19, Mass.

QUICK Money! "Repairing Car Batteries!" At home! Easy, too! Batteryman, Grand Junction, Colorado.

NATURAL Molding Latex, Extra thick. Free sample. W. Wooley, 115B Donald, Peoria, Illinois.

BOOKKEEPERS—Earn up to \$520 month serving small firms part or full time. Proved plan; simplified system. Particulars free. Tax Saver System, Dept. A, Ft. Worth 2, Texas.

INCOME from local information. No selling. Write—Neherco, La Verne 6, Calif.

HOMEWORK—Addressing envelopes. Details 25c. Siegal, Box 183-PS, New York 2.

MAKE Rubber Stamps, repair dolls, learn invisible reweaving, repair sewing machines. Catalogue of "40 Ideas." Universal, Box 1076-B, Peoria, Ill.

ONYX Baby Shoe Bases. Beautiful golden hue. New and appealing. Sample and prices \$1.00 C.O.D. Luna Gold Onyx Corporation, Deming, New Mexico.

EXTRA Money Easy, grind, sharpen scissors and shears at home. Complete electric outfit—year guarantee, instructions \$9.75 ppd. Check or M.O. Bob Crosby Enterprises, 1611 W. Weldon, Fresno, Calif.

"MAKE Perfume" Profitable Mailorder business—Catalogue Free. "International", 6347 Parnell—PS-1, Chicago 21, Ill.

PROFITABLE home business. Electroplate novelties, auto-parts, mirrors, baby shoes, etc. Portable Tyco Electro-Plater \$5.95. Free booklet. Tyco Metals, Box 13231-CE, Houston 19, Texas.

FREE Folder—100 Ways To Make Money In Silk Screen Printing. No experience—art ability needed. National, Box 88-PS, Dorchester 22, Mass.

MAKE money addressing envelopes! Our instructions explain how. Malco Company, 1-PS, Columbus 5, Ohio.

INVISIBLE Reweaving—big profits, big demand, easy-to-learn with low-cost complete course—nothing else to buy, ever. Details free, write today; Fabricon, Dept. K, 8342 Prairie Ave., Chicago 19, Ill.

MONEY in new greaseless doughnuts. Start in kitchen. No smoke. Sell stores. Free recipes. S. Ray Co., 3605 South 15 Ave., Minneapolis 7, Minn.

A BIG-Paying Business For a Man in His 50's. One of our men makes \$11,000 in a year . . . other top men in their 50's earn up to \$5,000 to \$8,000 right from the start. We pay earnings in advance. Require no investment. Write confidential letter to Vice President, Dept. PS, Box 676, Dayton 1, Ohio.

FREE particulars "Profitable Home Business Projects" plus wholesale sources, 740,000 items. Cottage Industries, Omaha 12, Nebraska.

\$250 WEEK reported! Free book "505 Odd, Successful Businesses." Work home! Expect something Odd! Pacific-73C, Oceanside, California.

\$46 FROM Square Foot Plywood; Jigsaw necessary. Write: Woodart, Bridgewater, Massachusetts.

GROW Mushrooms, Cellar, shed, Spare, full time. We pay \$3.00 pound. Free Book, Mushrooms, 2954 Admiral Way, Seattle, Washington.

TIN-Cans. Turn them into cash. Nine methods, Instructions 50c. Charles Company, 12-CMG, Norwood, Ohio.

POPULAR SCIENCE OPPORTUNITIES

MAIL Selling \$100 weekly! Write. Wehner, Box 142-E, Roxbury 19, Mass.

\$1,500 YEARLY Possible, in spare time, operating mailorder bookshop. Instructive manual, details 25c. Lawson Company, Drawer 1486-A1, Detroit 31.

SAWDUST. Turn it into cash. Twenty methods. Instructions 50c. Charles Company, 12-CMF, Norwood, Ohio.

MEN-Women—"Everybody likes Candy." Learn to make professionally at home. (Our 40th year.) Ragsdale Candies, East Orange, New Jersey.

PROFITABLE Lifetime Mail Order Business. Lock Box 1553, Erie 8, Pa.

EARN Money At Home With Your Typewriter! Spare time! Details free. Edwards, Publisher, 3915-PS, 12th, Des Moines 13, Ia.

ADDRESS Envelopes, Postals, at home—longhand, typewriter. Particulars free! Carl Z. Torrey, Melrose 76, Mass.

BUY it wholesale. Manufacturers, Distributors. Over 850,000 items. Literature free. Olsen, 1231-B East Third St., Duluth 5, Minnesota.

PHONOGRAPH Records Buy at 5c. Resell 50c. Details 25c. Midstates, Box 412, Bloomington, Indiana.

CASH Income from your backyard! Unusual Businesses! Pikett's, Florence, Ky.

MAILING postcards selling repeat merchandise is profitable. Everything supplied. Details free. Gordon Publishers, Box 23, Pawtucket, R. I.

38 MONEYMAKING OPPORTUNITIES

QUICK profits taking magazine subscriptions, handling greeting cards. Cassell Publishers Service, Westfield, N. J.

DETECTIVES Earn Big Money. Experience unnecessary. Detective Particulars free. Wagoner, P-125 West 86th, N. Y. 24.

SCHOOL Seniors—Earn sensational profits selling classmates America's Most Beautiful Graduation Name Cards. Largest selection. Outsell all others. Free sample kit. Printcraft, Dept. P, 1425 E. Elm Street, Scranton 5, Penna.

\$10,800 PROFITS At Home! Lifetime Opportunity! Free advertising method builds your own Home Mailorder Business! Capital, experience unnecessary. Start spare time. No merchandise investment! No advertising risk! Exciting; practical. Copyrighted, notarized proven successful plan 25c. Satisfaction guaranteed! Treasury, 149 Storer, New Rochelle 4-P, New York.

ADJUSTERS Needed Now! Excellent high pay positions open with airlines, insurance companies and government departments. Send for Free book. Write Today, Universal Schools, P-123, Box 8202, Dallas 5, Texas.

\$\$\$ IN Personalized Baby Record Books. Sell By Mail Use Same Literature We Do. No-Co-Ro, Oakland 6-P, Calif.

BE Appointed State Notary Public Now! Details; Stationers, Helotes, Texas.

MAKE Money addressing Envelopes at Home! Our information reveals how. Only 30c. Business Bureau, Dept. 45-A, P.O. Box 2224, St. Louis, Mo.

WIN Cash, cars in prize contests! Write for copy filled with current Contests, winning hints and tips. Send only 30c. Wright Contest Digest, Dept. 20-A, P. O. Box 2266, St. Louis 9, Mo.

MANUFACTURE Rhinestone and Pearl Jewelry at home. Latest creations, tremendous profits, no skill needed. Postcard brings illustrated catalog of settings, stones, etc. A. V. Cutt Co. Inc., 210-H Fifth Ave., New York 10, New York.

PRINT Without A Printing Press. Big Money! See page 56.

EARN Money Evenings, copying and duplicating comic cartoons for advertisers. Adservice, Argyle 2, Wisconsin.

BUILD Quick Photo Camera Plans \$2.00. Martin, 3943 Ottawa, Chicago 34.

LEARN Mailorder Selling. Free Details. Greenlawn Enterprises, 15378 Greenlawn, Detroit 21, Michigan.

FREE Book "505 Odd, Successful Businesses" Work Home! Expect something Odd! Pacific-74C, Oceanside, Calif.

\$100-\$200 WEEKLY. No selling or manufacturing. Part or full-time. Mahaffey, 3032-A Weldon, Los Angeles 65.

WE pay you highest rates for hand-decorating greeting cards. Work home. Experience unnecessary. No selling required. Greetings, 100 Madison, Detroit 26.

ASSOCIATE: \$100 starts you operating "multiple" motion pictures as Owner-Exhibitor, earning \$15 day. Particulars free. Studio, 52599 Hollywood, Hollywood, Calif.

TURN Your spare time into better health and bigger profits. Details stamp. Celesta, 2233 Eastern Ave., Indianapolis 18, Ind.

LUNCH Counter Game. Start route. "Collecto." Box 929, Long Beach 1, Calif.

39 FORMULAS, PLANS, ETC.

FORMULAS, trade secrets, for nearly everything. Catalog free. Creative Publishers, Winnetka 7, Illinois.

LATEST manufacturing formulas, for profitable, easy to make chemical specialties. Lists free. Automotive Chemical Laboratories, Box 393-B, Hicksville, N. Y.

FORMULAS—All kinds. Latest products. Literature free. Kemico, Park Ridge 15, Ill.

FORMULAS—\$1.00 each. Send no money—Pay on Approval, Kelly, 9544 Whitcomb, Detroit 27, Michigan.

ANY Formula \$2.00. Satisfaction guaranteed. Jack, Chemist, 4292 Parkside, Philadelphia.

LABORATORY tested formulas. Lists free. Pont, Box 635-PS, Terre Haute, Ind.

500 FORMULAS \$1.00, 10,000 Formulas \$14.00. N. Green, Corinth, New York.

NEW Formulas for 1952 Big Profit Products Now Ready. Lists Free! Fifty Years Supplying the Best. Miller Chemicals, Tampa, Florida.

FORMULAS, latest. Catalog—Chemical Instruction Sheet 10c. Belfort, 216 West Jackson, Chicago 6.

40 PLASTICS

LUCITE, Plexiglas. Any size sheets masked Square foot (12 x 12) cost 1/16" \$1.20; 1/8", \$1.40; 3/16", \$1.75; 1/4", \$2.08. Include 10% postage. Almac Plastics, 230 Fifth Avenue, New York 1, New York.

FREE Illustrated Price Lists. Tapered Drills—Rotary Files—Burs—Metal Findings—Dyes—Materials—Supplies. Retail—Wholesale. Caraday, Box 71, Ryder Sta., Brooklyn 34, New York.

LEARN Plastics at home. Small cost—Spare time. Dime brings sample plastic, three experiments, full details. Plastic Projects, Box 5151, Detroit 35, Mich.

HI-Profits—Gifts—Jewelry—Free catalogue, details, Pilot Plastics, 67-B Fulton St., New York City 38.

PLASTIC: sheets, rods, tubing: Lucite, Acetate, send \$1.50 for 4 pound assortment and instruction manual. Regal Plastic Supply, 720 Main, Kansas City 6, Missouri.

PLASTIC Sheets, Rods, Tubes, etc. Free List, Plastic Supply Co., 2901 N. Grand Blvd., St. Louis 7, Mo.

NEW liquid casting plastic. Clear, colors. Embed flowers, insects, coins. Saw, drill, carve. Send 25c for Wholesale Catalog and New Sales Manual showing how to make money at home. Castolite, Dept. A-102, Woodstock, Illinois.

PLASTIC Sheets—Carving Blocks—Supplies Below List Price. Send Stamp for List. Canton Plastics Inc., 211 7th Street, S.E., Canton, Ohio.

PLASTICRAFTERS supplies wholesale. Literature 20c. Cosmopolitan, Box 176-PS, New York 8, N. Y.

41 CHEMICALS & APPARATUS

NEW Idea Chemical and Apparatus Outfits for Home Experimenting. Photo-Scales, Microscopes, Chemicals, Biological and Laboratory Supplies in Small Quantities. Catalog 25c. Established 1931. John H. Winn, 124-B West 23rd Street, New York 11, N. Y.

LUMINOUS Paints will glow in dark. Six colors. Fairmount Chemical Co., 136 Liberty St., New York City 6.

LABORATORY Apparatus, Chemicals, Microscopes, Complete Chemistry Sets, Minerals, Uranium Ore. 10c brings catalog. Porter Chemical Company, Hagerstown 2, Maryland.

SPECTROSCOPE for quick chemical analysis \$3.00. Cutting Sons, Los Altos, Cal.

SAVE Money! Supplies Catalog 15c, refundable. Laboratory Sales, Box 161, Brighton, Mass.

OH Boy! New Book of Science. Experiments, Formulas, Secret Processes, together with Catalogue of Laboratory Supplies, Only 25c. National Scientific Company, Dept. 15, 2204 North Avenue, Chicago 47, Illinois.

ILLUSTRATED Catalog: Chemistry, mineralogy, biology, 10c. Tracey Laboratories, Evanston, Illinois.

CHEMICALS and apparatus for industrial, analytical, and private laboratories. Catalog 20c. Dept. M-26, Biological Supply Co., 1176 Mt. Hope Ave., Rochester 20, N. Y.

42 HELP WANTED

FOREIGN & Latin American Employment 1952 "Foreign Service Directory" gives Up-To-Minute Facts on Military & Civilian Construction, Government Jobs, Major Oil Listings, Aviation, Transportation, Steamship Lines, Mining, Importers, Exporters, How-When-Where to apply, application forms, Hot List Firms Hiring, \$1.00 post-paid, Global Reports, P.O. Box 883-S, Hollywood 28, Calif.

FOREIGN Employment Construction men, building trades, helpers, office men, others, interested in Foreign Projects. High wages, quarters, trans. Listings of firms actively working on U. S., Foreign, Intercontinental Projects. Send \$1 for Foreign Construction Compendium and Application Forms. Foreign Service Bureau, Dept. PS-1, Box 295, Metuchen, New Jersey. (Not an employment agency—no fees.)

ALASKA—Last American Frontier. \$1.00 brings 1952 Business Directory, Government Map, Construction Projects Military & Civilian, Homestead & Highway facts, Hunting-Fishing-Game Rules, Mining, Aviation. List of firms hiring. How-When-Where to apply. Alaska Opportunist, P. O. Box 883-S, Hollywood 28, California.

CONSTRUCTION Job List. Published Monthly. \$1.00. Dempster's Construction Scout News, Dept. 268-DG, Bridgeport, Ill.

\$1,000,000 CONSTRUCTION Projects, "World Wide" printed Monthly Foreign & Domestic employment. Free application blanks tells How-When-Where to apply. \$1.00 complete. Global Reports, P.O. Box 883-PX, Hollywood 28, California.

HONOLULU Help Wanted columns airmailed \$1.00. Pomeroy's, #3 Campbell Block, Honolulu, Hawaii.

43 AGENTS WANTED

BUY wholesale 25,000 items, catalogue 25c. Matthews, 1472-A6, Broadway, N.Y.C.

NEW Jobs open in selling! Send name, address for five free issues of Opportunity Magazine's money-making guide, listing hundreds of companies who'll pay you well, full or part-time. No experience needed. Opportunity, 28 E. Jackson, Dept. 18, Chicago 4, Illinois.

DRESSES 18c; Coats \$2.00; Blouses 35c; Free Catalogue; Crown, 164-PB, Monroe Street, New York 2.

NEED Extra Cash? Take orders for personal initialed belts and buckles, cap badges, tie holders, etc. Choice of 3000 emblems. Free sales kit. Hook-Fast, Dept. 1425PS, Providence, R. I.

MAKE Wedding Profits. Sell invitations, napkins, matches. Samples free. Dunbar's, Middlebush 5, N. J.

AGENTS—300% profit selling genuine gold window letters; stores and offices. Free samples. Metallic Letter Co., 437 N. Clark, Chicago.

START Your Own Business on credit. Always your own boss. 1,437 Dealers sold \$5,000 to \$28,500 in 1950; their average \$6,704. We supply stocks, equipment on credit. 200 home necessities. Selling experience unnecessary to start. Wonderful opportunity to own pleasant, profitable business backed by world-wide industry. Write Rawleigh's, Dept. A-U-PSC, Freeport, Ill.

POPULAR SCIENCE OPPORTUNITIES

COMMERCIAL Deep Frying Course. Mock Chicken Legs, Potatoes. New and proven methods. Learn about this money-making field. \$2.50. PP. Concession. Toledo 13. Ohio.

GOLD Lacquered and Silver Sign Letters. Windows, Doors, Trucks, Standard sizes. Penny each. Free samples. Atlas-G. 544 West 79th. Chicago 20.

WHERE to Buy 800,000 articles direct from Manufacturers. Save by buying direct. Sent Free. "Your Profits Under The Spotlight." Glass Pub. Co., Ellwood City 4. Pennsylvania.

AGENTS outside New York State: private label Home products, selling aids. Jack Love, 265 Huntington, Buffalo 14. N. Y.

"FOG-Stop" Windshield Cloth. Instantly removes blurry Mist, Frost, Sleet, Snow. Stops windshield fogging. Samples sent on trial. Kristee 140. Akron, Ohio.

SCHOOL Seniors! A postal will bring you our wonder, Kwick-Sell Cardalog of popular Graduation Name Cards. Biggest profits! Only firm giving free Golden Memory Book and Souvenir Chest. Don't miss out. Hurry that postal! Craftcards, Box 235 (m), Pittsburgh 30, Pa.

MAN to earn \$100 week up. Long needed invention. Advertised Saturday Evening Post, Colliers. Prospects everywhere. Full or part time. Exclusive. No investment. Free samples. Write Red Comet, Inc., Dept. 81-A. Littleton, Colorado.

FREE Samples. and amazing plan giving you gorgeous Dress without penny cost. Rush name today, with dress size. Harford, Dept. G-235. Cincinnati 25. Ohio.

NEED Money \$50-\$100 and more is yours—easily, pleasantly, quickly. In spare time just show friends irresistible Elmira assortments of all-occasion greeting cards, wrappings, personalized stationery, napkins, matches, many other exclusive, profitable specialties. No investment. No experience. Success assured. Bonus. Special Prizes. Promptest Service. Write Today. Free samples, assortments on approval. Elmira Greeting Card Co., Elmira 113. N.Y.

WANT to make real money? You can positively make \$50.00 a day and up selling a brand new item going to every type of Food and Beverage Store, Factories, Laboratories, Hospitals, etc. First time advertised. Write for Free details today. Johnson-Hartmann, 53 West Jackson Blvd., Dept. PS-01. Chicago 4. Illinois.

"DRY" Wallpaper Cleaner. No messy liquids. No sticky "dough". Simply brush wallpaper, painted walls. Samples sent on trial. Kristee 141. Akron, Ohio.

JUST Out! New Thrilling sensation in Everyday Cards, Rich foils, satins, velours sell on sight, 21 for \$1. Make up to 100% profit. 50 Assortments, Imprint Stationery and Book Matches, Gift Items. Two \$1 Assortments on approval, Imprints Free! Joy Greetings, 507 N. Cardinal, Dept. P-61. St. Louis, Missouri.

I'LL Put A "Shoe Store Business" In Your Pocket! Nation's Leader trains you to make Big Money! Fit men, women. Free Sample Outfit—Write Today! Consolidated Shoe System, Dept. CI-102, Chipewewa Falls, Wisconsin.

BE A Money Maker . . . Use your home as magazine headquarters. Liberal commissions. No experience—No capital needed. Everything furnished. Write for Free Catalog. McGregor Magazine Agency, Dept. 510A. Mount Morris, Illinois.

GET Into Million Dollar Work Clothes Business! Earn big money now, unlimited future! Sell finest-quality, embroidered uniforms and work clothes to factories, garages, service stations, lumber yards, everybody! Huge profits possible. No experience needed. Gorgeous selling kit, actual fabric samples, everything Free! Write Topps, Dept. 541, Rochester, Ind.

SELL Sunshine Exclusive Everyday Cards and make Big Money the easy friendly Sunshine way. Complete selection greeting cards, stationery, gift wraps, novelties, etc. 21 DeLuxe Miniature Everyday cards—75c. Many others. Send postcard today for your Sunshine Sample Kit on approval to: Sunshine Art Studios, Dept. PS-1, 115 Fulton St., New York 38, New York.

MAKE Money Fast—Sell big value Greeting Cards. Four new 21 card \$1.00 All-Occasion Assortments, Birthday, Easter, Novelty cards, Gift Wrappings, Stationery, Notes, Unusual Gift Items. Over 100 fast-sellers. Amazing profits. Write for Samples on Approval and "Get-Started" Plan. Hedenkamp, 361 Broadway, Dept. PS-14. New York.

AT Last! Something New and Sensational in Everyday Cards, 21 for \$1. Make Extra Money Fast! Show Satin, Velour, Metallic Cards. Get orders easy. Big line \$1 Assortments, Scented Stationery, Personal Matches, Kiddie Books, Imprints Free. Two \$1 boxes on approval. Puro Co., 2801 Locust, Dept. 241-A, St. Louis 3, Mo.

PHOTO-Salesmen-Agents. Sell beautiful hand colored plastic enlargements and sensational new photo compacts, rings, bracelets, locket, etc. Collect deposit, we deliver. Profitable sideline. Send card for Free sample kit. Novel Portrait Co., 3343-A North Ave., Chicago, Ill.

DO You Need Money? \$40.00 is yours for selling only 50 boxes of our 300 Greeting Card line. And this can be done in a single day. Free samples. Other leading boxes on approval. Many surprise items. Experience unnecessary. Free samples Personalized Stationery, Napkins. Write today. It costs you nothing to try. Cheerful Card Co., 426 White Plains, New York.

CALIFORNIA sweet smelling beads, sensational sellers. Particulars free. Mission, 2328P West Pico, Los Angeles 6. Calif.

LOOK! Extra Money for vacations, unpaid bills, savings, charities. Sell friends Greeting Cards, Gift Wrappings, Gifts. Experience unnecessary. Big Profits. Bonus. Surprise Gift Offers. Request Feature All-Occasion assortments on approval. Free samples Name Imprinted Stationery, Napkins, Towels and Free Catalog. New England Art Publishers, North Abington 604-B. Mass.

ABSOLUTELY Free! Big package actual sample fabrics and style presentation of dresses, lingerie, hosiery, etc. Take orders. Commissions big. Send no money. Melville Co., Dept. 6617. Cincinnati 25. Ohio.

ALL-Occasion Greeting Cards that are such terrific sellers all you have to do is show them. 21 boxed sell for \$1.00. Over 100 other wonderful boxes including Birthday, Get-Well, etc. Profits to 100% plus bonus. Write for free samples. Kit on approval. Regal Greeting Card Co., Dept. 35, Ferndale, Mich.

MAKE money introducing world's cutest children's dresses. Big selection adorable styles. Low prices. Complete display free. Rush name. Harford, Dept. G2341. Cincinnati 25. Ohio.

UP to \$50.00 in a week spare time and tailored suit for yourself without paying one cent. Write for plan and Free Sample Case. Progress Tailoring Company, Dept. B-221, 500 S. Throop, Chicago 7, Illinois.

MEN! You can make a fortune if you join us now. We are introducing Kantlash. Greatest fishing equipment accessory ever manufactured. Sales already pouring in. We want distributors immediately! Retail \$2.95. Big, easy profits. Write today! Kantlash, Evanston 8. Illinois.

MAGIC words give you daily cash! "Kendex nylons are free unless satisfactory". New style 300 only 98c including your commission, bonus and postage. If these wonderful sheer DuPont nylon stockings run, snag or are not satisfactory within 1½ months of receipt, we refund the full 98c so they will cost nothing! What woman will hesitate to wear fine nylons at our risk? Just write orders. We deliver and collect. Advance cash plus huge bonus. Spare or full time. No experience necessary. Postcard brings you sample stocking and money-making outfit free and prepaid. No obligation. Kendex Corporation, Babylon 44. N. Y.

BIG Profits. Fast sales with 7 sensational new items! Free Samples! Durever, 2781-K, Atlantic Avenue, Brooklyn, N. Y.

WHOLESALE Deal. Power mowers. Extra profit. Sell other dealers. Rotacut-PS. Excelsior Springs, Mo.

SELL New Automatic Floor Waxed. Retail \$2.95. Profit 125%. Write J. Smith, Inc., Greenfield 36, Mass.

ANYONE can sell Hoover DuPont Nylon Uniforms for beauty shops, waitresses, doctors, nurses, others. In white and colors. Exclusive styles. Top quality. Low priced. Exceptional income. Real future. Equipment free. Write fully. Hoover, Dept. A-101. New York 11. N. Y.

"ADVANCE Commissions—Addressing Envelopes!" Homework! Instructions, 25c! Hirsch, Spring Valley 3. New York.

MEXICAN feather pictures. Sell on sight; 200% profit! Free details; sample 10c stamps. Sylvia-ST, Apartado 9036, Mexico City.

SELL Big Money-Maker to Men and Women. Easy handwork makes fast-selling useful articles. Sample free. Sunmade Company, Brockton 64. Mass.

MAKE Money Calling On Friends. Show nationally advertised Greeting Cards—new All-Occasion Assortment and laugh-packed Barrel-of-Fun. Also sensational Pinafores & Parasols Personal Notes. All three dollar sellers. Up to 50c profit for you. Big line, includes Gift Wrappings, Stationery, Gift Items, etc. Get Three assortments on approval. Write Wallace Brown, 225 Fifth Ave., Dept. G-4, New York 10.

FAST sellers. Big demand. Catalog. Parker Drug Co., Hoboken 6, New Jersey.

NEED Extra Cash?—Get it selling Blair's unusual line of household and food products. Every housewife a prospect. Send for samples Free. Write Blair, Dept. 55HA, Lynchburg, Virginia.

AMAZING discovery. Master Glaze, puts brilliant glass-like surface on cars. Free sample, information. Big commissions. Master Glaze, Dept. 735, 7720 Harwood, Milwaukee, Wisconsin.

BUY Wholesale thousands nationally advertised products at big discount. Sent free "The Wholesale Plan." American Buyers' Service, 629-T Linden, Buffalo, N. Y.

NICKEL Silver key checks—Key check stamping Outfits. Catalog free. General Products, 11PS, No. Pearl, Albany, N. Y.

FREE book "505 Odd, Successful Businesses." Work Home! Expect something Odd! Pacific-71C, Oceanside, Calif.

SALESMEN, Distributors, fast selling costume jewelry direct from factory. Big picture catalog free. Pickcraft, C-19 Bank, Attleboro, Massachusetts.

SELL \$2 Fire Extinguishers. Locally. Mailorder. Lorrac, Box 1086S, Albany 1, N. Y.

44 HIGH-GRADE SALESMEN

MAKE money showing neighbors how to beautify yards with glorious flowering shrubs and trees. Quick-bearing Dwarf fruit trees; World-Famous Stark Patented Varieties produce abundant harvests champion-quality apples, pears, peaches, other fruits. Even small plots produce fruit for family-use and to sell. Beautiful Sales Kit Free. Stark Bro's., Dept. 30112, Louisiana, Missouri.

WRITE 3 Words—Collect \$7.65 on 10-second Demonstration to merchants—write on glass with Amazing Magic Crayon—Presto!—5-color advertising message takes fire—glows like brilliant Neon. Three sales daily bring \$22.95 profit. Rush postcard for details.—Complete Sales Kit, Free! Maxilume Co., 125 W. Hubbard, Dept. CL-9-A, Chicago 10, Illinois.

MAKE Money with fast-selling Bostonian Shirts. Blouses too. Spare time, full time. Sales Kit Free. Bostonian, 89 Bickford, Dept. M-11, Boston 30, Mass.

RICH Opportunity for Men in their 50's. Healthful, pleasant occupation. No investment needed. 150 of our men made \$500 to \$3,000 in one month; many just beginners. Heckman made \$104 first 2 hours; Crowley made \$224 first day; exceptional earnings. Openings available. Write President, Dept. PS, Box 711, Fort Worth 1, Texas. (If you live in Canada, write President, P. O. Box 88, Postal Station J, Dept. PS, Danforth, Toronto 6, Ontario.)

AD Matches! Sell Amazing Designs—20, 30, 40 and 240-light book matches. Biggest spot cash commissions; every business a prospect. Low prices for high quality. Repeats. Start without experience; men, women; full, part time. Buy Nothing! Sales kit furnished. Match Corp., Dept. PS-25 Chicago 32, Illinois.

POPULAR SCIENCE OPPORTUNITIES

ADVERTISING book matches—Cash in on big demand—sell Union Label matches. Cuts for all businesses and political parties—Free powerhouse selling kit—low prices—protection guaranteed on repeat orders—Cash commissions. Superior Match Co., Dept. P-152, 7530 Greenwood, Chicago.

45 EDUCATIONAL & INSTRUCTION

USED Correspondence Courses and Books sold and rented. Money back guarantee. Catalog free. (Courses Bought.) Lee Mountain, Pisgah, Alabama.

BOOKKEEPERS! Increase your earnings! Operate your own simplified "Dollar-A-Week" Bookkeeping and Tax Service. Full or spare time. Details Free. No obligation. Ellis, Box 203-A, Cedar Grove, N.C.

LEARN Piano Tuning, Repairing—at home in 30 days. Unlimited income. Phonograph recordings, tools and instructions furnished. Write Capitol City Tuning School, Department C-133, 129 East Michigan, Lansing 16, Michigan.

USED Correspondence Courses, Bought, Sold, Rented, Free list. Home-Study, 408 North High, Salem, Indiana.

DO you want Big Money? Men-Women adjusters needed by airlines, steamship lines, insurance companies. Qualify now. Many earning up to \$125 week. Free book. Write today. Universal Schools, P-143, Box 8202, Dallas 5, Texas.

PIANO Tuning Pays. Learn this profitable profession at home. Our Tonometer and mechanical aids make learning easy. No knowledge music necessary. Diploma granted. Largest and oldest school—51st year. G. I. Approved. Write for booklet. Niles Bryant School, 77 Bryant Bldg., Washington 16, D. C.

EARN more money by improving your mathematics, details free. Page Publications, McFarland, Wisconsin.

FREE "Career Chart". Write Professor Martin, Williamsburg, Michigan. Mention occupation.

TIRED Of No Money, second rate jobs? Like to start a real career with a lifetime of high salaries? Write me about two growing fields that really need men. Ed. Howes, Chief, National Schools, 4000 S. Figueroa Street, Los Angeles 37.

MEDICAL Laboratory Technicians in great demand. We train you in your own home. Catalogue free. Imperial Technical Institute, Box 973-B, Austin, Texas.

BECOME a Doctor of Psychology or Metaphysics. Teach secret of contentment, happiness. Win degree of PsD, or MsD. Solve mental worries. Free book. College of Universal Truth, 5153-K N. Clark, Chicago.

GUNSMITHING, learn now! Start earning good income. Our Residence Course is thorough, practical! Approved for qualifying Veterans; easy-pay plan for non-Vets. Part-time work arranged. Write: Pennsylvania Gunsmith School, 1000S Western, Pittsburgh.

GET 1952 Gov't Job! Start high as \$73.00 week. Men-Women. Thousands of Emergency Program Jobs available! Qualify Now. Experience usually unnecessary. Free 32-page book shows jobs, salaries, sample tests. Write today: Franklin Institute, Dept. E-22, Rochester, N. Y.

WONDER Drugs! Look under 'Personal' Bijou, Box 1727-XV, Hollywood 28, Calif.

WAKE Up your sleeping success ability with personal education home-study. Many helped. Free lecture sent in plain wrapper. Write Pres. Ballard, Box 1924-S, Louisville 1, Kentucky.

BARTENDING and Management, Home or School training. American Bartending School, P-334 S. Wabash, Chicago 4, Ill.

YOU can learn upholstery at home. Big opportunities! Write for Free literature. National Upholstery Institute, 6108 East 24th, Indianapolis.

STUDY for game warden, park, forestry, and patrol service. Write Delmar Institute, D16, Whittier, Calif.

MINERALOGY course, \$5.00. Western School Of Mineralogy And Mining Inc., Box 1130, Long Beach, Calif. Inquiries Appreciated.

WELDING training pays at Hobart Welding School, Box P-122, Troy, Ohio. VA Contract. Best equipment. Catalog Free.

PRACTICAL Nursing—Learn Easily at Home, Spare Time. Big demand, good earnings. High School not necessary. Write for free facts. Wayne School, Dept. FH-6, 2525 Sheffield, Chicago 14, Ill.

HIGH School—No Classes. Study at home. Spare time. Diploma awarded. Write for Free catalog. HBA-8, Wayne School, 2527 N. Sheffield, Chicago 14, Ill.

BANNISH Stammering, \$1.00. J. Allen, Box 114, Saskatoon, Sask., Canada.

BOOKKEEPERS operate Bookkeeping-Tax Consultant Service, Big earnings. Details free. Universal, Box 664-P, Springfield, Missouri.

INCREDIBLE! Unprecedented! Look under "Personal!" Bijou, Box 1727-VL, Hollywood 28 Calif.

46 CONTESTS

\$1000 **WON** by client. Contest Service. United, 13 Earl, Red Bank, N. J.

TIE-Breaker picture puzzles exposed, \$1.00. Winograd, Box 1495, Philadelphia 5, Penna.

47 DETECTIVES

DETECTIVES—Work home—Travel. Experience unnecessary. Detective Particulars free. Write, Wagoner, P-125 West 86th, New York 24.

DETECTIVE Training. Phillips Secret Service System, 1917-C North Kenneth, Chicago 39, Ill.

DETECTIVES needed in every town. Hanna, 8118 Fielding, Tampa, Florida.

48 LANGUAGE OUTFITS

LISTEN, Learn A Language by Linguaphone. At home, quickly, easily, correctly master Spanish, French, German, Russian, Asiatic—any of 29 languages through Linguaphone Conversational Method. Add to service, job, travel opportunities. Send for Free book. Approved for Veterans' Training. Linguaphone Institute, 5401, Radio City, N. Y. C.

50 BUSINESS SERVICE, INFORMATION, NAME LISTS

SELL by radio without risk! Pay "per order." Further details, 10c. (Refundable.) Simon—C1, 59 Park Ave., New York City 16.

MAILING Lists. All kinds 1000 \$5.00. Dixie Service, King, N. Carolina.

ADDRESSES Names 1000 Only—Never been used \$5.00 Cash. Mullins, 715 East 11th St., Junction City, Kansas.

51 SPECIAL SERVICES

LONG Beach—Los Angeles remailed 25c. M. Tapp, 10855 Calif. St., Lynwood, Calif.

52 AUTHORS SERVICE

"TEN Steps To Writing Success" reveals How you can write stories, poems, articles for publication. Details Free. Will Herwell, 7016 Euclid, Cleveland 3, Ohio.

I Want New Writers. Experience unnecessary. Earn at home, spare time. Details Free. Saunders M. Cummings, 468-15 Independence Bldg., Colorado Springs, Colo.

LOOKING For A Publisher? Write for free booklet PS-2, Vantage Press, 230 West 41st, New York.

53 ADVERTISING

ADVERTISE at no cost, \$4,000 sales from Free ads. Publicity Advertising, 1501 Trails End, Kalamazoo, Michigan.

24 WORDS in 50 Weeklies, \$4.96. H. J. Darnell, 730 Hays, Jackson, Tennessee.

ADVERTISE: 24 words, 40 Newspapers, \$3.50. Lists Free. Advertising Bureau, 10511-P Springfield, Chicago 43.

54 CARTOONING, SIGN PAINTING, CHALK TALKS

"HOW To Make Money With Simple Cartoons"—A book everyone who likes to draw should have. It is free; no obligation. Simply address Cartoonists' Exchange, Dept. 191-C, Pleasant Hill, Ohio.

LEARN Cartooning, Illustrating, Portrait Drawing, Showcard Writing, etc., quickly with our new, easy methods. Catalog Free. National Artists, 801 North Mar-salis, C-2, Dallas 3, Texas.

ARTISTIC back dated Art Magazines, eight \$1.00 postpaid. Wonderful courses, drawing, painting, cartooning. Free catalog. Art Book Shop, Arnold 5, Missouri.

CHALK Talks. Laugh Producing Program, \$1.00. Illustrated Catalog 10c. Cartoonist Balda, Oshkosh, Wisconsin.

LEARN Sign Painting at Home. Test Lesson Free. Ben Kerns, Box 812-PS, Greenville, South Carolina.

55 TYPEWRITERS & OFFICE MACHINES

TYPEWRITERS \$22.50. Duplicators, Adders \$13.50. Typewriters, 118 Spruce, Wichita 7, Kansas.

ADDING Machines, Portable, Guaranteed. Only \$6.95 postpaid! Crestwood, Independence 9 Missouri.

ADDING machines, typewriters, new portables, office size typewriters wholesale. Enclose 10c for catalogues. Apple, 993A Westchester Ave., New York City 59.

ROTARY Stencil Printing Machines, \$24.50 up. Mechanical Addressers, \$10.95 up. Duplicator, Addresser, Office Supplies. Dorsett, 2215 So. Walnut, Muncie, Indiana.

TYPEWRITERS, Printing Devices, Office Machines supplies appliances. Dixie Graph, King, N. Carolina.

56 RUBBER STAMPS & OFFICE SUPPLIES

3 LINES 50c; Pads 35c; Signatures \$2.00. Printright, Wauwatosa, Wisconsin.

BETTER Stamps reasonable. Prompt Service. Catalogue. Johnson, Box 6-B, New York City 26.

57 PRINTING, MULTIGRAPHING, ETC.

1,000 BUSINESS cards \$2.35. Prepaid. Other printing. W. Dornfeld, Iron Ridge 6, Wisconsin.

1000 BUSINESS Cards \$2.50 Prepaid samples Free. Reliable Print Shop, 905 East Jefferson, Louisville 6, Ky.

PHOTO Offset Lithography, Forms, catalogs, folders etc. Amazingly low cost. Free estimators chart. Printing Consultants, Box 636, Newark 1, N. J.

PRINT Without A Printing Press. Big Money! See page 56.

5000 6³/₄ ENVELOPES printed \$3.10 per thousand. 1000 Embossed business cards \$3.95. Samples free. Michel, Box 76E, New York 16.

QUALITY Printing. Stationery, circulars, booklets, publications. Free catalog. Adams, 30 West Washington, Chicago 2, Ill.

BUSINESS Printing. Samples, prices free. Howprint, 723-S Eunice, Webster Groves 19, Missouri.

FREE Samples, prices. Quality work postpaid. Fast service. Sutton Printing, Box 853-S, Waycross, Georgia.

MILITARY Stationery Name, insignia, processed gold, large box \$1.95 cash. Wainwright, Dolgeville, New York.

100 8¹/₂x11 HAMMERMILL Letterheads and 100 envelopes \$2.00. Benneville Printing, Box 1931, Pittsburgh 30, Penna.

SPECIAL! 1000 Embossed Business Cards \$3.00. News-Messenger, S. Lancaster, Mass.

1000 =10 WHITE Wove Envelopes \$7.00. Mercury Press, Box 69-S, Marengo, Iowa.

100 8¹/₂x11 LETTERHEADS \$1.00 Postpaid. Envelopes same. Race Printing, Hudson, New York.

58 PRINTING OUTFITS, SUPPLIES

PRINT your own cards, stationery, circulars, advertising. Save money. Simple rules. Print for others, nice profit. Raised printing like engraving too. Have home shop. Details free. Kelsey Presses, L-8, Meriden, Connecticut.

PRESSES, Cutters, Kelly—Heidelberg Automatics, Cabinets, Supplies. Requirements?? Levinson, 263 Mercer, Jersey City 2, New Jersey.

MAKE your Own, self-molding, rubber printing cuts. Plexirubber, Argyle 2, Wisc.

PRESSES, Supplies, Paper, catalog 10c. Custom, Box 211-S, Springfield, Missouri.

59 PATENT ATTORNEYS

INVENTORS: Write for free brochure "Evidence of Invention." Labiner, World Building, New York 7.

"INVENTOR'S Guide" free. Frank B. Ledermann, Registered Patent Attorney, 154 Nassau Street, New York.

INVENTORS. For "Invention Record" form, contact Carl Miller, Registered Patent Attorney, Woolworth Building, New York.

PATENT Protection—This well-known organization will send you promptly upon request and without obligation, a booklet containing detailed information concerning steps to take to protect your invention by a United States Patent. Victor J. Evans & Co., Merlin M. Evans, Registered Patent Attorney, 741-A, Merlin Building, Washington 6, D. C.

INVENTORS: Learn how to protect your invention. Unless the inventor is familiar with patent matters, he should engage a competent registered patent attorney or agent to represent him. We are registered to practice before the U. S. Patent Office and prepared to serve you in handling your patent matters. "Patent Guide for the Inventor" containing detailed information concerning patent protection and procedure with "Record of Invention" form will be forwarded to you upon request—without obligation. Clarence A. O'Brien & Harvey Jacobson, Registered Patent Attorneys, 22A-A District National Building, Washington, D. C.

C. A. Snow & Co.—S-427, Snow Building, Washington 1, D. C. Registered Patent Attorneys. Write for information.

INVENTORS: Without obligation, write for information explaining the steps you should take to secure a Patent. John N. Randolph, Registered Patent Attorney, 207 Columbian Bldg., Washington 1, D. C.

INVENTORS—If you believe you have an invention, you should find out how to protect it. The firm of McMorrow, Berman & Davidson with offices in Washington, D. C., is qualified to take the necessary steps for you. Send for copy of our Patent Booklet "How to Protect Your Invention." We will also send you an "Invention Record" form. No obligation. They are yours for the asking. McMorrow, Berman & Davidson, Registered Patent Attorneys, 1439 Victor Building, Washington 1, D. C.

INVENTORS: When you are satisfied that you have invented something of value write me, without obligation, for information as to what steps you should take to secure a Patent. Write Patrick D. Beavers, Registered Patent Atty., 938 Columbian Bldg., Washington 1, D. C.

PATENTS—Irving L. McCathran, 316 McLachlen Bldg., Washington 1, D. C. Registered Patent Attorney.

60 FOR INVENTORS

INVENTORS: Without obligation, write for information explaining the steps you should take to secure a Patent on your invention. John N. Randolph, Registered Patent Attorney, 206 Columbian Bldg., Washington 1, D. C.

CASH For your idea, 280 manufacturers need inventions, patented or unpatented. List free, Invention Bureau, 208-S Clinton, Oak Park, Illinois.

INVENTORS. For "Invention Record" form, contact Carl Miller, Registered Patent Attorney, Woolworth Building, New York.

INVENTORS: If you have an invention for sale, patented or unpatented, write Institute of American Inventors, Dept. 30A, 631-E St., N.W., Washington 6, D. C.

INVENTIONS Promoted. Patented or Unpatented, Established 1911. Write Adam Fisher Company, 183 Enright, St. Louis, Mo.

INVENTORS—If you consider your invention to be something of importance, take steps to protect it with a United States Patent which gives you the right to exclude others from making, using and selling your invention as claimed. "Patent Protection for Inventors" outlines steps to take to secure patent protection. Mailed promptly without obligation. Victor J. Evans & Co., Merlin M. Evans, Registered Patent Attorney, 742-A Merlin Building, Washington 6, D. C.

INVENTORS: Learn how to protect your invention. Unless the inventor is familiar with patent matters, he should engage a competent registered patent attorney or agent to represent him. We are registered to practice before the U. S. Patent Office and prepared to serve you in handling your patent matters. "Patent Guide for the Inventor" containing detailed information concerning patent protection and procedure with "Record of Invention" form will be forwarded to you upon request—without obligation. Clarence A. O'Brien & Harvey Jacobson, Registered Patent Attorneys, 22A-A District National Building, Washington, D. C.

POOR Man's Tale Of A Patent, by Charles Dickens. Wit and wisdom from pen of famous author. Experiences of inventor. Copy of this rare curio now, 30c. In Re Publications, 4627 Verplanck Place N.W., Washington 16, D. C.

INVENTORS! For "Copyright, Design and Patent Guide" contact Patent Attorney Metzler, 11 West 42nd, New York 18.

INVENTORS—If you believe you have an invention, you should find out how to protect it. The firm of McMorrow, Berman & Davidson with offices in Washington, D. C., is qualified to take the necessary steps for you. Send for copy of our Patent Booklet "How to Protect Your Invention." We will also send you an "Invention Record" form. No obligation. They are yours for the asking. McMorrow, Berman & Davidson, Registered Patent Attorneys, 1438 Victor Building, Washington 1, D. C.

PATENT Searches, \$5.00 including patent copies. Same reliable search as conducted for patent attorneys. Free protection forms, 48 hour service. Complete inventor's services. Patent Service Institute, 945-B Pennsylvania Avenue, Washington 4, D. C.

INVENTORS—Develop and market your invention through unique plan. Free literature. Inventors' Intermediaries Corp., 11 West 42nd St., New York 18, New York.

INVENTIONS promoted patented, unpatented. Complete services. M. Joyce Humphries, 1425 Landtitle, Philadelphia 10.

SEARCHES—Put your patent searches in the hands of a Registered Patent Attorney or Agent, as he qualifies to give a worthwhile patentability report. Record of Invention form upon request and information on patent protection. Patrick D. Beavers, Registered Patent Attorney, 939 Columbian Bldg., Washington 1, D. C.

NEW Ideas, Inventions promoted. Patented, Unpatented, Industry, Armed Forces. Write "New Ideas," Box 781, Marion, Ind.

PATENT Searches \$5.00, including copies of closest patents. Same reliable searches we conduct for Patent Attorneys. 48 hour Airmail Service. "Record of Invention" free. Capitol Patent Service, Box 664-S, Washington 4, D. C.

MR. Inventor, Are You Successful?—I can help you be a successful inventor. I was successful. Send for plan I followed. Max Cundiff, Saybrook 5, Illinois.

61 INVENTIONS WANTED

INVENTORS: Hundreds of manufacturers have requested our assistance in locating marketable new products. Complete information, free. Institute of American Inventors, Dept. 30C, 631-E Street, N.W., Washington 4, D. C.

INVENTIONS Promoted, Patented or Unpatented. Established 1911. Write Adam Fisher Company, 183 Enright, St. Louis, Mo.

INVENTIONS Wanted by Manufacturers. Patented-Pending only. Free Details. Inventors Exchange, Dept. D, Hartford 1, Conn.

INVENTIONS Wanted, Patented or Patent Pending. 21 years experience Promoting Inventions. National Service Bureau, 3122 Meramec, St. Louis 18, Mo.

INVENTORS—Good patented, patent pending inventions wanted by manufacturers. Booklet free. Market Contacts, 719-B2 Magnolia, Tupelo, Miss.

62 PATENTS FOR SALE

TWO patented wonder toys for sale. Write Arvin Gussa, 2123 Burrough Street, San Diego 11, Calif.

U. S. 2494172 Canada 473912 Calculator, Slide Charts. Henry Griesbaum, Route 2, Elkland, Missouri.

64 MODELS, MODEL SUPPLIES

SHIP and Yacht model fittings: blueprints. Send 25c for illustrated catalog No. 26—Listing hundreds of items. A. J. Fisher, 1002-2 Etowah, Royal Oak, Mich.

BUILD Historic ship models, complete kits, 50c to \$9. Catalog 15c. Ideal Models, 21 West 18th, New York 11, N. Y.

BUILD, Fly Luscombe, Piper, Aeronca "Quicky" 18" scale models, all for \$2.00. Glue 15c extra. Airplane folder, 3c. Cleveland Model, 4508TC209 Lorain, Cleveland 2, Ohio.

WORLD'S Finest Model Railroad Catalog Handbook 35c. Hobbycraft Catalog 25c. No stamps. Print name, E and H, Dept. 80, 130 West Chelton, Philadelphia 44.

HOME Models and Doll Houses are fun to build—profitable to sell—with our accurately scaled, pre-fabricated materials. Send 10c for samples and booklet, "How You Can Build Model Homes." Architectural Model Materials, Inc., Dept. S12, 4208 Armitage Ave., Chicago 39.

SHIP Model and yacht supplies, complete large 64 page catalogue, 30c. Wm. Wild, 510 E. 11th St., New York City.

FAMOUS Catalogs, Ships (120 pg. Historic Models, hundreds fittings) 50c. Worlds Electric Trains & Accessories 50c. H. O. Scale Trains (ready Dec.) 50c. Old time vehicles 15c. Hobby books 10c. Collectors soldiers 25c. Polks Hobbies, 314-S 5th Ave., New York City 1, N. Y.

STOP don't put your trains away. Enjoy miniature railroading the year round. Toy Trains Magazine tells how. Send \$1.00 for next four issues. Money refunded if not satisfied. Toy Trains, Ramsey 30, N. J.

BRASS Gears and model supplies for the inventor. Send 10c for catalog. Pierce Model Works, Tinley Park, Ill.

STEAM engines, boilers, castings, Catalog 25c. Anton Bohaboy, 2297 Price, Rahway, New Jersey.

65 HOME CRAFTSMAN

LEATHER, tools, lacing, supplies. Free Catalog. National Handicraft, 199 William St., New York 7.

TURN your spare time into cash. Make quick-selling, highly profitable lamps—every home a prospect. No experience or special tools required. New 1952 56-page illustrated catalog shows shades, shade frames, figurines and bases, oil lamp converters, boring compounds, and dozens of similar items. Also all kinds of sockets, cords, pipes, harps, finials, bases, and hundreds of other parts—everything you need. Special 8-page section shows 6 beautiful lamps in kit form ready to assemble. You buy wholesale, sell at retail—make big profits. Hundreds doing it. You can, too. Send 25c today for catalog and wholesale price list. Refundable first order. Gearon Co., Dept. 500-A1, 27 S. Desplaines, Chicago 6, Illinois.

OUR biggest Leather and Craft Catalog yet! 1000's of items. Send 25c (refunded with 1st order). Russo Handicraft Supplies, Dept. 10, 245 S. Spring, Los Angeles, California.

FREE book "Practical Painting, Wood Finishing" shows how to get professional results. Furniture finishing, workshop projects, home decorating. Complete Modern brush and spray methods. Tricks you've never seen. It's Free! Write Home Craftsman, 115-F Worth St., New York 13.

LEATHERCRAFT. Everything needed by beginners, advanced hobbyists and professional leatherworkers. Largest stock of supplies in U. S. Moderate-priced tooling leathers, top quality calfskins, tools, supplies, kits. Send 10c for Big Catalog. J. C. Larson Co., 820 S. Tripp, Dept. 1576, Chicago 24, Illinois.

MAKE Leather Link Belts. No tools required. Kit and instructions, \$1.00. Tan, brown, black. Smadco, Box 86, Hammels, L.I., New York.

ABUNDANT low priced leathers. Make leather belts, billfolds, purses. Big Catalog Free. Tandy Leather, Box 397-D, Tulsa, Okla.

POPULAR SCIENCE OPPORTUNITIES

VIOLINMAKERS: Amateurs—Professionals. Fine tone European wood, materials, supplies. Illustrated catalogue 10c refunded. Premier Violin Supplies, Dept. V.P.S., 430 S. Broadway, Los Angeles 13, Calif.

JIGSAW. Bandsaw owners, let your machine bring extra profits, fun. Free details. Nu-Art, Dept. A, Box 2235, Boston, Mass.

MODERNIZE kitchen cabinets. Custom made slab doors, drawers, hardware, and atomic age accessories. Thombert Company, Newton 5, Iowa.

KNOCKDOWN Cedar Chest, Lumber and Veneers. Free Price List, Giles Co., Brownsboro, Alabama.

LEATHERCRAFT supplies catalog. Pleasure and profit. New style handbag patterns, belts, Leathercraft school G.I. approved, 25c for catalog (Refund 1st order). Dept. PS, Apache Leather Co., 2804 E. Washington St., Phoenix, Arizona.

100 FULL size jig saw patterns up to 20" high, only \$1.00. Pattern Service, Medway 8, Massachusetts.

MECHANICAL build mechanical-electrical device. Needed by auto and home owners. Engineered, tested product. New improved design. Inexpensive. Full particulars sent airmail. Enclose 25c. Refundable. Alwilson Products, Box 5091, Nashville, Tenn.

LEATHERCRAFTERS! Everything for the leather crafter, large illustrated catalog 10c. Art Leather, 411 Joseph Ave., Rochester 5, New York.

LEATHERCRAFT Tools, Lacings, H. Byrd, 3406 Montrose Avenue, Richmond, Va.

90 ALL new, full size lawn ornament and novelty patterns, up to 20" high. Only \$1.00. Mastercraft 122S, 7041 Olcott, Chicago 31, Illinois.

FAMOUS. full-sized U-Bild wood patterns by Steve Ellingson of California, featured in "Look" and "American" magazines. Trace pattern on wood. Saw it out. Put it together. Paint it. Minimum Tools required. Illustrated folder showing 56 designs furniture, toys, novelties, on request. Kennedy Sales Co., 4299 Pacific Ave., Detroit 4, Michigan.

80 FULL sized patterns Lawn Ornaments, Toys, Novelties \$1.00. Modern Woodcraft, Saginaw, Mich.

LEATHERCRAFT, Copper tooling, textile painting, many other crafts. Big free catalog shows everything you need. Kit Kraft, 7377 Melrose, Hollywood 46, Calif.

LANDSCAPING increases value and charm of your home. Customized Plan \$10.00. Details, Buell, Box 84, Baltimore 10, Maryland.

LEATHERCRAFT Tools, Leather Embossing Plates, Craft Accessories, Dies, Catalogue 10c. Louis Jones Engineering Company, 1613 Main, Fort Worth, Texas.

LEATHERCRAFTERS—metal ornaments—buckles—pocketbook accessories. Cosmopolitan Metalcrafters, Box 176-PS, New York 8.

SQUAREKNOTTERS: Make belts, hand bags, etc. Quality cord samples with catalog free. Special! Beginner's book, catalog and samples 10c. P. C. Herwig Co., Dept. P40, 121 Sands St., Brooklyn 1, N. Y.

89 FULL size Jig Saw patterns of beautiful shelves, ornaments, toys, novelties. Plus "How, Where to Sell." Only \$1.00. Mastercraft 124S, 7041 Olcott, Chicago 31, Illinois.

66 BUILD IT YOURSELF

BUILD Your Own "Tractor". Free information. Eltraco D-5, Camptonville, Calif.

OUTDOOR Lamppost with illuminated house numbers. Simplified plans and instructions \$1.00. G. M. Turk, 169 Behnke Avenue, Paramus, New Jersey.

GRANDFATHER Clock shoptested plans dollar. Thousands bilt. Kuempel Clocks, Minneapolis 16.

BUILD with Concrete, Fieldstone, Earth. Movable Form System cuts costs. Construction simplified. Free literature. Smith PS, Box 36, Eagle Creek, Oregon.

BUILD inexpensive concrete blockmaker, motor-hand. Write, Clyde Lee, Mountain View 1, Oklahoma.

VAN De Graaff "lightning" generator, laboratory tested, spectacular, surefire. Teachers manual, hobbyist construction guide, \$2.50. American Electrostatic Company, Box 221, Tulsa, Okla.

STREAMLINED. Built-in Kitchen cabinets to fit any kitchen. Illustrated manual describes designing and construction. All for \$1.00. Thombert Company, Newton 11, Iowa.

FREE Handbook, build sawmills, block machines, freezers, tractors, scooters, 250 shop, farm, home machines. Nichols Co., Dept. C-1400, Purvis, Miss.

MOWER kits while available. Center Assembly. Send for literature now. Monarch, 2008 South Holbrook St., Ft. Scott, Kans.

FREE Plans for building rotary power lawn mower. No Obligation. Low factory price on any or all essential parts. Also complete mowers. B-M Mower Company, Box 66-PS, Blue Mound, Kansas.

"CONCRETE Block Homes." This amazing 32 page booklet has helped thousands build their own homes. Send \$1.00. H. C. Lightfoot, Civil Engineer, Richboro, Penna.

67 OLD GOLD, JEWELRY, WATCHES, ETC.

NEW catalog lists over 5,000 styles! Gold plated jewelry supplies, Rhinestones, Pearls, etc. Complete details, only 10c. Barry's 47-12 Branford Place, Newark 2, N. J.

HIGHEST Cash Paid For Old, Broken Jewelry, Gold Teeth, Watches, Silverware, Diamonds, Spectacles, Platinum. Free information, Satisfaction Guaranteed, Rose Smelting Company, 29-Y East Madison, Chicago.

RHINESTONES, jewelry settings, cameos, sequins, beads. Send 10c for Illustrated Catalog. J & M Novelties, Dept. CA-4, Griffith, Indiana.

GOLD plated Jewelry Supplies, Rhinestones, Moonstones, Pearls, catalogue 10c. Hobby Shop, 99 Prospect St., Paterson, N. J.

JEWELRY Making Catalog, Milady-Fair Co., 35 Maiden Lane, New York City 38.

ASSEMBLE rhinestone jewelry. Introductory assortment \$1.00. Montague, Box 746, Wilmington, Delaware.

68 TOBACCO & PIPES

CIGARS—Clear Havana, handmade. Regularly 15c. \$5.50 for fifty postpaid. Save \$2.00! Check or money order. C.O.D. (you pay charges). Seco Cigars, Rochelle Park, New Jersey.

PIPES, Pipemaking kits, Instructions, circular 10c. Carvapipe, 2829-A Dixie, Hamilton, Ohio.

CIGARETTES—Roll 200 mild-tasty for 75c. Particulars free. Pete Moberly, Box 841, Owensboro, Kentucky.

69 FOR THE HOME

CESSPOOL trouble? Use Peps-It. Rejuvenates fermentation action, saves pumping costs, deodorizes, recuces masses. Costs only \$2.50. Safe, Sanitary. Free descriptive literature. Chemical Cesspool Cleaning Co., Boston 34, Mass.

WATER Softeners. Buy direct from factory, save money. Write for price list. Shursoft Water Softener Co., 4242 W. Lisbon Ave., Milwaukee 8, Wisc.

70 OF INTEREST TO WOMEN

VENETIAN Blind tape. Plastic or Cotton 30c yard. Free color chart. Moore, B461, Kittanning, Pa.

71 FOR SALE MISCELLANEOUS

DRESSES 18c; Coats \$2.00; Blouses 35c. Free Catalogue. Crown, 164-PS Monroe Street, New York 2.

EVERYDAY gift wrapping paper, 30 sheets \$1.50. Celesta, 2233 Eastern Ave., Indianapolis 18, Indiana.

72 WANTED MISCELLANEOUS

SCRAP Mercury (Quicksilver) Tantalum—Bismuth—Tungsten, Metallurgical Products Co., Established 1909, 35th & Moore Sts., Philadelphia 45, Pa.

MERCURY—Highest prices. Free Containers. Write Mercury Terminal, Norwood, Mass.

IF you want to trade, sell anything, send \$1 for big list firms, individuals, coast to coast, who buy, trade almost anything under the sun. Toole, Bernardin Apts., Evansville, Indiana.

75 TATTOOING SUPPLIES

TATTOOING Outfits, Supplies, Illustrated List 25c. Zeiss, 728 Lesley, Rockford, Illinois.

76 DRAWING, SUPPLIES & EQUIPMENT

DRAFTING and artists' materials catalog—thousands of items—25c (deductible first \$2 order). Gordon's, 219 Madison, Chicago.

DRAW Beautiful Human Figures, 25c per lesson. Aldcroft Studios, 1206 Maple, Los Angeles 15.

SEND \$1.00 for six test art lessons, questions, art opportunities answers. Illustrators, Box 8066, Dallas 5, Texas.

77 TREASURE FINDERS

WHERE to Search for Buried Treasures (Maps—Pictures). Only \$2. Treasure Press, Dept. A, Crown Point, Indiana.

TREASURE Hunters! New 11-pound featherweight Model 101 locator for gold, silver and minerals. Money-back guarantee best available. Also Geiger Counters for uranium prospectors. Complete information free. The Goldak Company, 1540 W. Glenoaks Blvd., Glendale 1, Calif.

GOLD, Silver, Metal Detectors. Geiger Counters for Uranium, Mineralights. Sensational new fully guaranteed models. None Finer. Information Free. Detectron Co., 5631 Cahuenga Blvd., North Hollywood, California.

SELECTIVE Metal & Mineral Detector. Revolutionary design. Distinguishes metals from black sands; readily detects metals under salt water. Free literature. Gardiner Electronics Co., Dept. 22, 2018 N. Dayton, Phoenix, Arizona.

78 WATCH REPAIRING

5 **ELGIN,** Waltham, Illinois. Hampden Gents' wristwatches, needing slight repairs, \$18. Write for prices. B. Lowe, Holland Bldg., St. Louis 1, Mo.

WATCHES Completely Repaired \$3.50. Guaranteed. Rauner, 572 W. 187th Street, New York 33, N. Y.

"**THE** Modern Clock." All about clock repair, 502 pages, 173 illustrations, \$4.95 postpaid, 10-day return privilege. North American, Dept. 21K, 2018 North Avenue, Chicago 47, Ill.

WATCHMAKERS' hobbyists' complete informative catalog 20c. Bengal Company, Culver City, Calif.

79 MISCELLANEOUS

DRESSES 18c; Coats \$2.00; Blouses 35c. Free Catalogue. Crown, 164-PC Monroe Street, N. Y. 2.

OUTDOOR Toilets, Cesspools, Septic Tanks cleaned, deodorized with amazing new product. Just mix dry powder with water; pour into toilet. Safe, no poisons. Save digging, pumping costs. Postcard brings free details. Burson Laboratories, Dent, E-53, Chicago 22, Illinois.

YOUR Leather Jacket renovated expertly. Free circular, Beriew Mfg. Co., Dept. 7, Freeport, N. Y.

RECEIVE Giant Mails, magazines, catalogs! Three months 25c, year 50c. Wadell's Directory, 341-D East 76th, New York 21.

OUTDOOR Toilets Cleaned, Deodorized! Cut digging, pumping, moving costs. Safe, economical. Details Free. Wilmette Farm Supply, Dept. 95, Wilmette, Illinois.

PORTABLE Electric hot air heater complete with thermostat. Write for free bulletin. Johnson, 1638 Granville, Chicago, Ill.

GET plenty power from new kind, low, homemade windmill. No mortising, riveting, welding. Write: Ziembaj, 6123 Orchard, Dearborn, Mich.

MEDICAL Laboratory Technicians in great demand. We train you in your own home. Catalogue free. Imperial Technical Institute, Box 973-B, Austin, Texas.

POPULAR SCIENCE OPPORTUNITIES

SMASH worry, nerves, indecision and inferiority with personal education home-study. Many helped. Free lecture sent in plain wrapper. Write Pres. Ballard, Box 1924-T, Louisville 1, Kentucky.

HAIRCUT as you like it. Free circular. Booklet 25c. Mastrolia, 5¹/₂-BL Jane, New York City 14.

MEN—Thrilling new experience awaits you in effortless shaving. Nothing like it! Exciting details free. Write: Kenmore Distributors, 3819-P Kenmore, Chicago 13.

40 PIECE Big Mail 25c, name listed Directory; year service \$1.00. Harvey Teeple, Decatur, Indiana.

MASS-psychology Charts, calculated by Subconscious reactions of your present or prospective Employees, at \$1.00 per name, will increase your employee or Group business efficiency to an unlimited percentage per year. H. H. Bradford, 1010 So. Main St., Dayton 9, Ohio.

PANNING Gold lesson—Catalogue Beginners supplies, Mining Books, Maps, "Where To Go", Free. Old Prospector, Box 729D2, Lodi, Calif.

SIGNS & Decals of Every Kind, Free Information. Display Co., 2118¹/₂ Yale St., Houston, Texas.

BIG 13 ft. balloons \$6.50. Great Air Attraction Parlor Corp., Greenwood Lake, N. Y.

80 PERSONAL

"HOW Can I Find Out?" You Can! Information discreetly developed. Any matter, person, problem, anywhere. Worldwide. Officially licensed, bonded service. Established 1922. Reasonable. Confidential. William Herman, 170 Broadway, N. Y.

DETECTIVE'S Opportunities. Detective Particulars free. Write, Wagoner, P-125 West 86th, New York 24.

NEWARK Postmark Remails 25c. Conti, 92 Columbia St., Woodridge, N. J.

INCREDIBLE! Unprecedented! Become a mental superman overnight! Floor everybody! No studying! 'Memoprop' does all your thinking! It's uncanny! Revolutionary! Write: Bijou, Box 1727-VL, Hollywood 28, Calif.

CONFIDENTIAL information for single persons. Copyrighted literature explains future happiness. Mailed Free upon request. Strone, Box 157-PS, New York 11.

CHOOSE your career! Achieve success, security, happiness. Send \$1.00 for newly perfected scientific, psychological Interest Analysis. Guidance Consultants, Box 992, Newark, New Jersey.

PSORIASIS Victims: Hopeless? New Discovery! Free Trial offer. Write Pixacol, Box 7097-S, Cleveland, Ohio.

RUPTURED? Positive comfort, no understraps, no steel, no elastic. Write Smith Manufacturing Co., Preston, Ontario.

CONFIDENTIAL information for single people, leading to happiness, romance. Write today! Dr. K. Miles, B.S., M.S., Ph.D., Human Relations Counselor, 601-G South Vermont, Los Angeles 5, Calif.

PAPERHANGERS: Mix Mannatex Compound with paste. Prevents damp-mold, keeps wallpaper from cracking, makes it stick. Guaranteed Trial Size \$1.00 P.P. Paperhangers Supply Co., P. O. Box 37, Louisville 1, Kentucky.

MAKE Money addressing envelopes, mailing circulars. Complete instructions, 25c. "Leaderbrand", Cal Allen 3, Texas.

WONDER Drugs! Painless dentist's drills! Atomic cures! Rejuvenation! Latest medical discoveries! Unique, lifesaving knowledge! 'Your Medical Scrapbook' tells everything! Write: Bijou, Box 1727-XV, Hollywood 28, California.

PSORIASIS Sufferers: Free Literature "How To Combat Psoriasis." Dermoco Company, 355-A Imperial, Youngstown 9, O.

BORROW by mail. Loans \$50 to \$600 to employed men and women. Easy, quick. Completely confidential. No endorsers. Repay in convenient monthly payments. Details free in plain envelope. Give occupation. State Finance Co., 323 Securities Bldg., Dept. G-14, Omaha 2, Nebraska.

PILES! Tormented with the irritation and discomfort due to piles? Write for free important information. Mutal Products, Box 836-P, Cleveland 22, Ohio.

LETTERS remailed 50c, scenic cards 25c. "Johannes" Angloweg 7, Curacao.

ALASKA Remail Service, your letters re-aimailed 35c each, 3 for \$1.00. Smiley Burnette, P. O. Box 978, Anchorage, Alaska.

PERSONAL problems analyzed; correspondence or conference. Please anticipate delay. August Cesare, Box 755, Youngstown, Ohio.

HAIR getting thin? Troubled by dandruff, itch, local scalp disorders? Then write for important information. Don't wait 'til you're bald. S. Viggiano, 6556 Ladson, Pittsburgh 6, Penna.

INFORMATION for single people by Human Relations Consultant, Dr. B. Long, Box 375, Los Angeles 53, Calif.

"**INTERESTING Mails**"—25c keeps your mail box full three months. Bentz, Desk-E/39, Chatawa, Mississippi.

VALUABLE Big Mails, four months listing, 25c. Wright Publications, 2276 Hubbard, Memphis 8, Tennessee.

LETTERS Remailed 25c each. Anderson, G.P.O. Box 7866, Philadelphia 1, Pa.

SUCCESS Simplified! Become a financial wizard; a mental giant; an athletic Superman; a romantic magnet; an expert in any field! Free literature. Success Society of America, Box 5852, Cleveland 1, Ohio.

MEXICAN Law, General Practice Attorney, 1203 Arizona Street, El Paso, Texas.

For BIG MEN only!

SIZES 10 to 16 WIDTHS AAA to EEE

SEND FOR FREE CATALOG

WE SPECIALIZE in large sizes only—sizes 10 to 16; widths AAA to EEE. Loungers; Nylon Mesh; Dress Oxfords; Moccasins; High and Low Work Shoes; Slippers; Rubbers; Overshoes; Sox. Enjoy the finest in fit, comfort, style at amazingly low cost. Sold by mail only. Write for FREE Style Book TODAY!

KING-SIZE, Inc., 832, Brockton, Mass.

Amazing Attachment MAKES OLD REFRIGERATORS INTO MODERN Automatic Defrosters!

Thirty Million Prospects. Sell without "selling pressure" on sensational Free Trial Plan. Just plug it in and leave it. Frees women from drudgery and mess of defrosting. Saves electricity. Keeps food longer, better. Gives longer life to refrigerator. Secret "follow-up" Plan often brings five additional sales by making every user your agent. Big season now on!

SENT FREE... JUST SEND NAME!

Don't send a cent—just your name on penny postcard. We'll send you the biggest money-maker you ever got your hands on and guarantee your sales at profits as high as \$5.00 on each sale. Rush your name!

Women buying by the thousands!

Salesmen Cleaning up on "Free Trial" Sales Plan Sent Free with Instructions.

Make as high as \$5 on Every Sale!

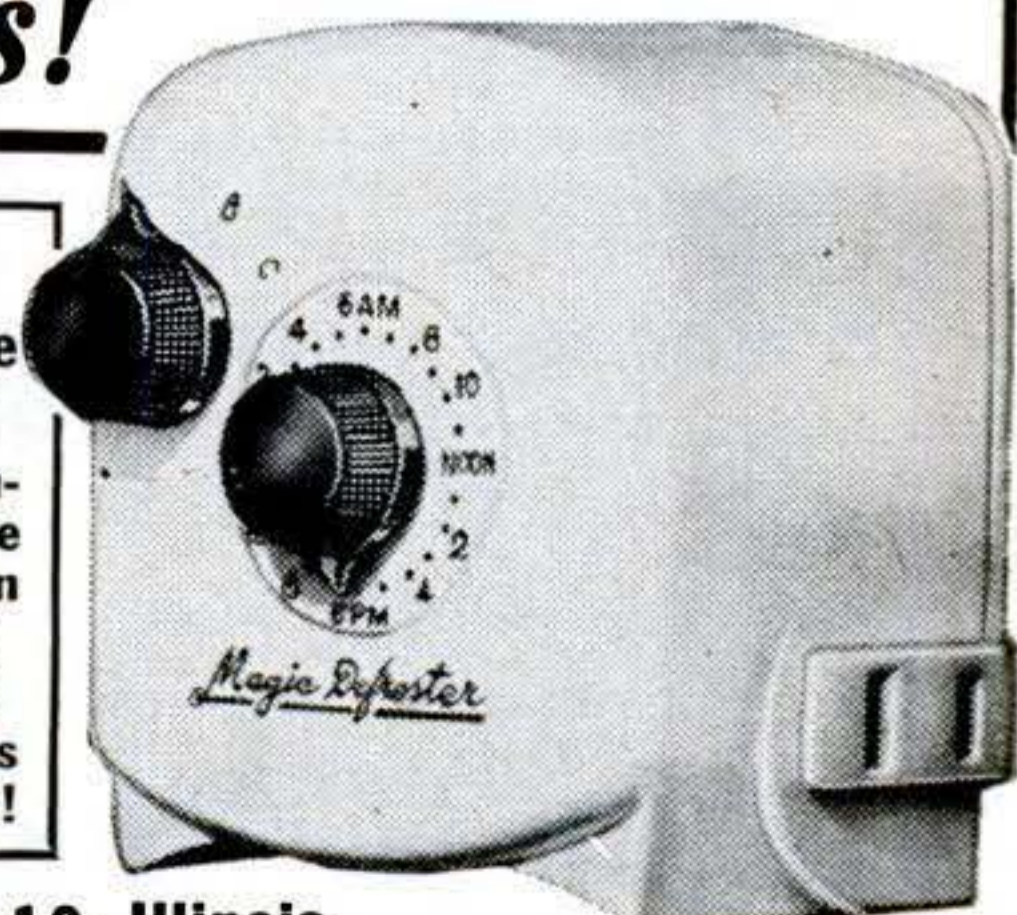

MAXILUME COMPANY, 125 West Hubbard Street, Dept. D-9-A, Chicago 10, Illinois

\$47⁵⁰ LIST VALUE

Only
\$17⁸⁸

3-SPEED Record Changer



Popular General Instruments Automatic Changer. Plays 7", 10" and 12" records at 33-1/3, 45 and 78 RPM . . . plays them All automatically from One tone arm and permanent long life needle—simply and easily. All adjustments in front. Capacity is (12) 10" or (10) 12" records at 78 or 33-1/3 RPM or (14) 7" 33-1/3 or 45 RPM records. Build new or modernize old record players and radio-phono combinations at less than 1/2 usual cost. Mounting space required 12 x 12 3/4", 5 1/2" above, 3" below motor plate. Operates on 105-125 V. 60 cycles AC. Shpg. wt. 19 1/2 lbs. No. 34A216. Brand New—Fully Guaranteed. **\$17.88** While They Last, Special Each. Include allowance for postage if shipment by parcel post is desired.

BURSTEIN-APPLEBEE CO.
Dept. C, 1012-14 McGee St.
Kansas City 6, Mo.

I enclose \$.....for.....Changers.
 Send me FREE your 1952 Catalog No. 521.
Name.....
Address.....
City.....State.....



1952 HARLEY-DAVIDSON HYDRA-GLIDE®
with the **MIGHTIEST MOTOR** in MOTORCYCLING!

Built like the costliest car. Has the newest deluxe features... super-power OHV motor, Hydra-Glide steering ease and riding comfort, 4-speed foot shift-hand clutch, Parco-Lubricated valves. A lifetime of fun! See your dealer. Write for FREE "Enthusiast" magazine and literature on 1952 models. **HARLEY-DAVIDSON MOTOR CO.** Dept. PS. Milwaukee 1, Wisconsin



Assemble a

Roberts
KIT-CRAFT
BOAT

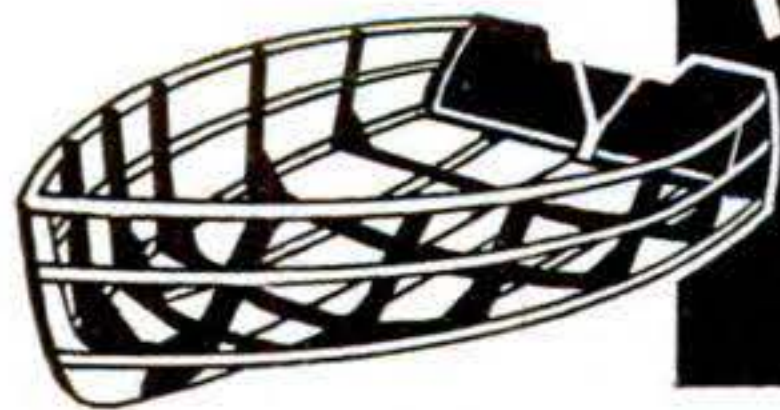

You can have a strong, fully guaranteed Roberts Kit-Craft Boat and save 50% by assembling it yourself. Finest marine materials . . . all brass screws . . . no "throw-away" jig required. All parts prefabricated!

12 MODELS ☆ 8 to 18' ☆ FROM \$42.50
Prams — Cartops — Skiffs — Rowboats — Cruisers
Sailing Prams — Speed Hulls — Runabouts

Send for big colorful catalog with dozens of action photos . . . 25¢, deductible from first order.

Roberts Industries, Inc.
1170 North Main St., Branford, Conn.

FOR SPORTS — FOR FUN
World's Finest "EM-GE"

BLANK PISTOL

"Shoot the Works"—safely—with this handsome blank pistol. Looks, feels and sounds like "the real thing." But it can't hold regular cartridges. Six-shot magazine; safety catch. Precision-built of carbon steel. 3 1/4" long. A world-famous pistol, excellent value at... **\$10.95**



De luxe model with pearl handle **\$15.00**

100 blank cartridges \$1.50

J. L. GALEF & SON, Dep't. L-7, 85 Chambers St., N.Y.C.

ORDER BY MAIL
No Permit Required.
Send Check or Money Order.
Dealer Inquiries Invited

GROW WITHOUT SOIL!



YOU can grow vegetables, flowers or rare plants without soil (HYDROPONICS) every day of the year. Start this fast, clean EASY way to grow any plant for fun or PROFIT now. Big returns from small space. Send postcard today for FREE picture book showing how others from every state are succeeding in this new wide open field.

C. GILBERT & CO., Box 22 Pt. Loma, San Diego 6, Calif.

SHIP MODEL KITS



Largest supply in New England. Fittings — Blueprints — Books. All prices. Write Dept. PS52. **BIG ILLUSTRATED CATALOG** 25c
JAMES BLISS & CO., INC.
220 State St., Boston 9, Mass.

120 Years in Business

Our 460th Advertisement
REAL DIESEL ENGINE

\$2.95
● for planes, boats, midget cars
● 7500 RPM; 1/7 HP; ht. 3 1/2"; wt. 5 oz.

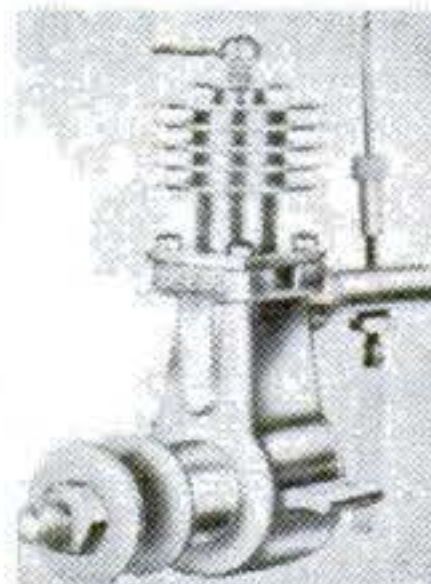

● precision machined for smooth operation
You just can't beat this price for a precision diesel engine! Streamlined, compact, easy to install. Thousands of satisfied users all over the world. Fast delivery if you ORDER TODAY! Send \$2.95 plus 25c postage.
Gotham Hobby Corp. Dept. S, 107 E. 126th St. New York 35, N.Y.

MAKE MONEY SELLING
ESHELMAN TRACTORS

Plowing Snow From Roads and Driveways

ESHELMAN 1 1/2-3.6 H.P.
\$95 PLUS TOOLS
MAKES WINTER JOBS EASIER
Also SNOW PLOWS & RIDING TRACTORS & POWER REVERSE
Women can operate it.
Free Catalog write Eshelman Dept. 285 119 Light St., Balto. 2, Md.

BRAND NEW 30 DAY FREE TRIAL



BUSHNELL Binoculars

High Power BINOCULARS

Finest Precision Optics
Featherlight
Money Back Guarantee
Easy Pay Plan
Leather Case Incl'd.

Free! Catalog & Book "How to Select Binoculars"
Dealer Inquiries Invited

Bushnell Bldg., Dept. P41 Pasadena 1, Calif.

AUTO SEAT COVERS

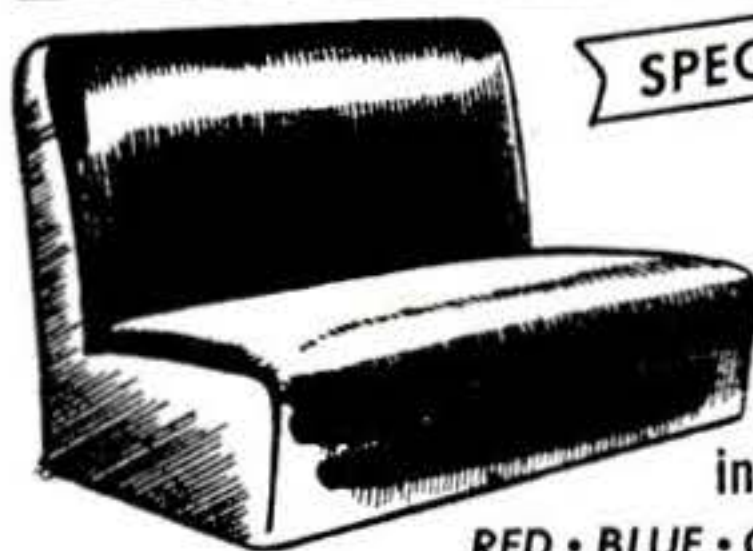

SPECIAL OFFER!

- Waterproof
- Stainproof
- Greaseproof
- Won't Burn

\$1.98

COUPE
OR
FRONT
SEAT

"MIRACLE PLASTIC"
in 5 LUSTROUS COLORS

RED • BLUE • GREEN • GRAY • MAROON

Add instant class to your car! Snap-on action holds 'em tight. Color fast. No fade! No shrink! Wash with damp cloth. **SEND NO MONEY!** Order TODAY at our risk! Give year and make of car, 2-door, 4-door, or coupe, and color preference. Pay postman plus postage. Or send Cash. Check or Money Order and We Pay Postage! Keep 10 days—return for full refund of purchase price if not fully satisfied, but, **HURRY**—they'll sell like hot cakes

Complete Set:
FRONT AND REAR
3.89

LEOPARD OR ZEBRA
Front Seat, 2.98
Complete Set, \$5

YOUNG PRODUCTS

Dept. 102 2605 Elmhurst, Detroit 6, Mich

CARE WILL SAVE



YOUR CAR



TALK—SING—PLAY OVER YOUR RADIO

with the real Radio Mike! Attaches in a jiffy—full instructions given! Swell for "parties"—"cut in" on or "kid" regular network programs or put on your own broadcasts! Amaze your friends—real fun. Beautiful Metallic Plastic 6 in. high! 12 RADIO BROADCAST LESSONS GIVEN with each mike. **SEND NO MONEY** Just pay postman \$3.99 COD plus postage or send \$3.99 and we pay postage! *Radio Mike* is available only from us by mail—guaranteed. Midway Co., Dept. MPS-1, Kearney, Nebr.



FIREARMS & SWORDS

You don't want to miss our new thrill-packed catalog. Fascinating background and illustrations of 1300 authentic pieces. Exceptional values in hard-to-find items. For your 120 page catalog #28 simply send 50c to cover postage and handling with your name and address.

ROBERT ABELS, Box PS, 860 Lexington Ave., New York 21, N. Y.

ELECTRICITY *Anywhere*

FOR PORTABLE, EMERGENCY OR HOME USE

ONAN Electric Plants generate 110-volt, 60-cycle current for homes, farms, cabins and resorts beyond the highline. Lightweight, portable plants cut costs, speed work for contractors. Standby plants protect hospitals, homes, civil defense units against power failure. 400 to 55,000 watts. Gasoline or Diesel-powered. Priced from \$219.00.

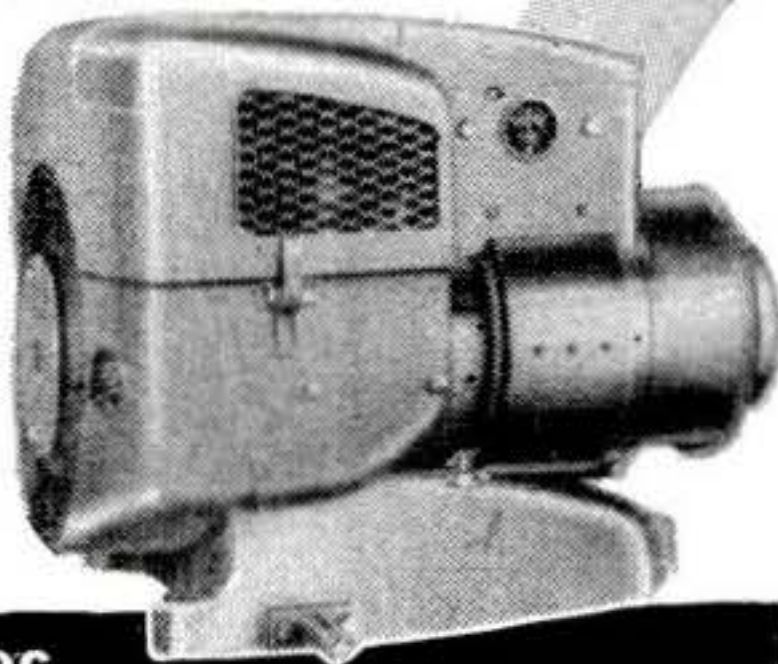

WRITE FOR CATALOG

D. W. ONAN & SONS INC.

6735 ROYALSTON AVE. • MINNEAPOLIS 5, MINN.



They're Such Fun and So Easy to Build!

ANTIQUE AUTO SETS

Only \$1.95 to \$3.95

Authentic Miniature 1/4" Scale Models of Old-time Autos!



1904 Olds—\$1.95



1911 Maxwell—\$2.50

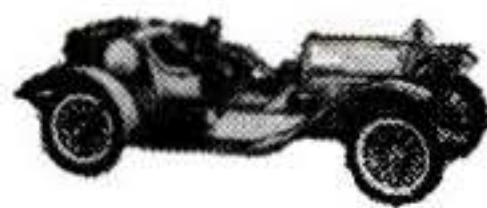

1914 Stutz Bearcat—\$3.95



1910 Model "T" Ford \$2.50



1911 Buick "Bug"—\$2.50



1909 Stanley Steamer \$2.95

Check "OLD TIMERS" You Want:

- | | |
|--|--|
| <input type="checkbox"/> 1911 Maxwell \$2.50 | <input type="checkbox"/> 1911 Buick "Bug" \$2.50 |
| <input type="checkbox"/> 1904 Olds \$1.95 | <input type="checkbox"/> 1903 A Ford \$2.50 |
| <input type="checkbox"/> 1910 T Ford \$2.50 | <input type="checkbox"/> 1902 Franklin \$2.50 |
| <input type="checkbox"/> 1909 Stanley Steamer \$2.95 | <input type="checkbox"/> 1906 Columbia Electric \$2.50 |
| <input type="checkbox"/> 1909 T Ford \$2.95 | <input type="checkbox"/> 1910 Internat. Harvester \$2.95 |
| <input type="checkbox"/> 1903 Rambler \$2.50 | <input type="checkbox"/> 1900 Packard \$2.50 |
| <input type="checkbox"/> 1913 Mercer Raceabout \$3.95 | <input type="checkbox"/> 1903 Cadillac \$2.50 |
| <input type="checkbox"/> 1906 "Old 16" Locomobile \$3.95 | <input type="checkbox"/> 1914 Stutz Bearcat \$3.95 |

Nostalgic miniatures—they bring the early days of the automobile back to life! Get ALL 16 MODELS for your den or library. 6" to 10 1/2" when completed. Pre-fabricated with all ready-shaped die-cut parts, plastic cast-wheels, lamps, radiator, horn, etc. Authentic history with each car; also step-by-step instructions that a 10-year old can follow with ease! At toy, hobby and dept. stores. Nationally known; money back if not satisfied. Wonderful for shut-ins and convalescents. Order a complete set!

Write to us—Add 25c for postage and handling. No. C. O. D.'s please.

HUDSON MINIATURES OLD TIMERS

"Originators of Antique Autos in Miniature"

SCRANTON HOBBY CENTER, Dept. 28, Scranton 10, Pa.

EXTRA CASH

for YOU!

TAKING ORDERS

Full Time—Spare Time for

STARK FRUIT TREES



Send No Money—You don't need experience to Make Money this

EASY WAY! Show friends, neighbors, others how to make small back yards, vacant lots, and tiny plots produce bushels of luscious, taste-tempting fruit—Apples, Pears, Plums, Peaches, Cherries, Berries, etc.—and cut food costs to the bone. Take orders for hardy, new, Quick-Bearing Stark Fruit Trees. Sensational U.S. Patent Leaders bring easy orders, pay you rich rewards in extra cash profits. Added income with beautiful Stark Ornamentals, Roses, Shrubs to home owners. Enormous demand for attractive landscaping. Stark Bro's is largest and oldest nursery in the world. Join the leader.

FREE SALES OUTFIT

AND BEAUTIFUL

PLATE BOOK—Everything you

need to make money—given you

FREE. Just send name, address

on Coupon below. No experience

is needed. Giant demonstration

Sales Outfit includes beautiful

color Photo Plate Book. Write

STARK BRO'S

Dept. 2912, Louisiana, Missouri



SENSATIONAL DWARF

FRUIT TREES

Ideal for backyard and vacant lot orchards. Yield fruit years earlier! One bushel or more of full size fruit from each tree. Plant up to 9 trees in only 20 ft. sq. plot. Sell everywhere—make money!



STARK BRO'S Dept. 2912, LOUISIANA, MISSOURI

Rush FREE Demonstration Sales Outfit. Include your new 1952 Stark Colorphoto Catalog—showing Stark Fruit, Berries, Ornamentals.

NAME _____ PSM 1-52

ADDRESS _____ COUNTY _____

TOWN _____ STATE _____

FREE! 10 HITLER STAMPS!



10 SCARCE STAMPS—ALL DIFFERENT—SENT FREE TO SECURE NAMES FOR OUR MAILING LIST

MAIL coupon at once. We'll send you this fascinating set of 10 Hitler stamps. Different sizes, colors, values. NO COST TO YOU. Stamps were issued by short-lived nation of Bohemia-Moravia. Much sought after. Now becoming SCARCE. Our supply is limited. Don't ask for more than one set. We'll also include other interesting offers for your inspection—PLUS a FREE copy of our helpful, informative book, "How to Collect Stamps."

This special offer may have to be withdrawn soon—so rush coupon NOW to: Littleton Stamp Co., Dept. PS-1, Littleton, N. H.

LITTLETON STAMP CO.
Dept. PS-1, Littleton, N. H.

Send me FREE the ten Hitler stamps and informative booklet, "How To Collect Stamps."

Name

Address

City State

ONLY \$13.95

NEW 1952 MODEL

HY-SCORE AIR PISTOL

- Most Powerful Air Gun On The Market
- Safe, No Pumping, No Extra Equipment To Buy
- 7 3/4" Barrel: Cal. .22 .77 or BB

HY-SCORE ARMS CORP., Dept 56
BROOKLYN 1, N.Y.

At Your Dealer or send cash or money order

FELLER, YOU WANT HY-SCORE

NEW! POLARVISION SAFETY LIGHT

A revolutionary new light discovery recently released for civilian use.

STOP HEADLIGHT GLARE

Fits All Cars & Trucks FOR SAFETY AND COMFORTABLE DRIVING

The Amazing "Ergon Glass Lens" is an integral part of the Polarvision Light. It produces a Black Light (barely visible to the eye) which Counteracts oncoming headlights, street lights, etc. without interfering with your visibility. Easy to Install above windshield—beautiful accessory. Light encased in high grade chrome holder. Works off car's central lighting circuit. Limited Supply. Complete (including all parts) \$6.95

Send cash, check, or money order. Guaranteed

Electronic Development Company, Dept. A-1 Los Angeles 34, Calif.

MAKE YOUR CAR LIGHTS—DIRECTIONAL SIGNALS TOO!

with this easily installed complete kit . . . Flashes turns . . . Eliminates hand signaling.

Only \$6.95 Postpaid C.O.D.'s Extra

All wire, bulbs, fixtures and materials supplied in complete kit, plus handsome control switch with reminder light that flashes when signals flash. Use existing parking & tail lights. No drilling necessary. No outside mountings. Easy-to-follow instructions. Tested & Approved to meet S.A.E. Standards.

Specify Make & Year of Car When Ordering. Money-Back Guarantee.

RAY PRODUCTS CO. 139-PC N. Clark St., Chicago 2, Ill.

SANDEE SPORTONE MUFFLERS

Ford & Chevrolet.....	\$ 4.45
All other popular cars.....	5.45
V-8 Dual Sets.....	15.95
Chromed Silentips.....	2.95

(Please state make & year of car on all orders.)

SANDEE MUFFLER CO.
5643 Corryne Place • Culver City, California

REAL LEATHER NAVY HELMET
NO HOOKS, TUBES OR HOLES

Brand new NAVY helmet of rich Cordovan Brown leather lined with soft warm fleece. Detachable chin strap. Ideal for flyers, cyclists, farmers, hunters. Children love them! Cost Gov't. \$10.00. Small, medium, large sizes. Send cash, chk. 25% dep. plus postage on COD. Money back guarantee. **\$2.00 pp.**

GRAND-HAWTHORNE SURPLUS
1439 S.E. Grand, Dept. PS1-52, Portland, Ore.

Reduce RADIO NOISES

NEW CLEAR-TONE LINE-NOISE ELIMINATOR

SIMPLY PLUG Radio or Appliance cord into Noise Eliminator and plug into wall socket. Enjoy reception FREE from many distracting noises. Send No Money, pay postman \$1.25 each (2 for \$2.00) plus postage or send cash and we'll mail postpaid. Try 5 days, money back if not delighted. Many hundreds of satisfied users. Send for yours today.

MERIT SALES, Dept. A-29 \$2.00
4225 Eldone Dr. Baltimore 29, Md.

FREE BINOCULAR CATALOG!

Listing over 60 sizes, types, of brand new binoculars including UNITED, German Carl Zeiss, Hensoldt; American Wollensack, Swiss, etc. Bargain priced from \$14.95 by America's leading Binocular Retailer. Written Guarantee certificate. Rush name for your FREE 20 PAGE two color money saving Binocular catalog.

UNITED BINOCULAR CO., Dept. ARF-5516
9043 S. Western, Chicago 20. Dealers Wanted

GIANT BALLOONS

Neoprene: Surplus Govt. Weather and Target Balloons. Terrific attention getters for Lodges, Civic Events, School Functions, Conventions, Exhibitions, Trade Shows. Advertise your special events in the Hollywood manner. Make any occasion a success. Great backyard fun. Marvelous for parties, dances, fairs, picnics, all festivities.

3 Ft. Dia. 39c 6 Ft. Dia. 79c 13 Ft. Dia. \$1.39

Add 10% For Postage and Handling. Calif. Res. add sales tax.

WAR ASSETS DIV.
VOLUME SALES CO.
Dept. S-1-52, 3930 Sunset Blvd., Los Angeles 29, Calif.

STOP WASTING GAS

CATCHES DROPS OF WASTE GAS HERE

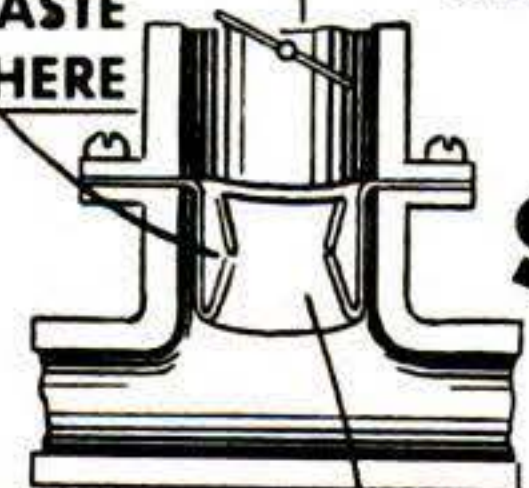

GET THE AMAZING ZIP-O

GAS MISER

\$2.95

SINGLE THROAT MODEL

Nothing like it. Captures the tiny drops of wasted liquefied gas that cause motor "roll," oil dilution, sluggish motor performance. Increases down-draft vacuum pressure and turns this waste gas into fully vaporized fuel for more power, better starting, extra mileage and SAVINGS.

INCREASES DOWN DRAFT PRESSURE AND VAPORIZES WASTE GAS HERE

Installed in a Jiffy—Never Wears Out!

Comes complete and ready to install. Simply loosen and remove bolts which hold carburetor on manifold, insert Zip-O and replace carburetor—THAT'S ALL. No other controls or accessories to buy. The Zip-O Gas Miser works automatically, and never wears out. The single throat \$2.95 model fits Chevrolet, Chrysler 6, DeSoto, Dodge, Plymouth, Olds 6, Nash 6, Hudson 6, KF, Studebaker Champ, Commodore, Dictator, Willys and Henry J. All others use double throat model at \$3.95. Give make and model when ordering. **MONEY BACK GUARANTEE:** Use the Zip-O Gas Miser for 10 days, if not fully satisfied, return and your money will be refunded.

DEALERS WANTED

PLYMOUTH MFG. CO., 10100 St. Clair Ave., Cleveland 8, Ohio

FREE CATALOG

All The Best and Latest Garden and Farm Books, Bulletins

A wealth of up-to-the-minute expert advice on how to do wonders on a little land or a thousand acres . . . wonders with flowers, vegetables, fruits, landscaping, poultry, livestock, woodlands, fishponds, composting, soil improvement, etc., etc. Just send name and address for this fascinating FREE catalog by return mail.

COUNTRY BOOKSTORE

Box 2801 Noroton, Conn. Estab. 1943

Build your own JET ENGINE!



SEND NO MONEY

Order these plans today

1. JET PROPELLED BICYCLE. Assemble your own. Photo and instructions \$1.00.
2. HOW TO MAKE EXPERIMENTAL JET ENGINES. Seven sheets drawings with information and instructions \$2.95.
3. BOTH OF ABOVE in one order \$3.75. SEND NO MONEY. Order both at once \$3.75 C.O.D. in USA plus c.o.d. postage. Send check or Money Order and we pay postage. Get other information too. Rush Order.

J. HOUSTON MAUPIN, Dept. 66, Tipp City, Ohio



No More Frozen Locks, Gas Lines or Gas Caps with the JET LOCK DEFROSTER

This compact, precision-built, scientific instrument works on a chemically-proven principle and will defrost the most stubborn lock or frozen surface in about twenty seconds. A jet of super-heated steam does the trick, and is guaranteed to work every time. Complete with 2 cartridges, **\$1.00** ONLY

Postage paid. Sorry no C.O.D.

COMMERCIAL SALES CO. Dept. PS-1, 1303 Fulton Street, Brooklyn 16, N.Y.

Saves Digging, Pumping, Moving!

OUTDOOR TOILETS CESS POOLS • SEPTIC TANKS Cleaned — Deodorized

Banish offensive odor of disposal units with amazing new product! Just mix dry powder with water and pour into outdoor toilet, cess pool or septic tank. That's all! Absolutely safe—nontoxic, no poisons. Works like magic to reduce mass, to unclog walls and pipes . . . to facilitate free and easy drainage. One treatment lasts months and months.

FREE! Just send your name and address on a postcard and get exciting details BY RETURN MAIL. Discover how you can clean, deodorize and sanitize your disposal unit QUICKLY and EASILY . . . at amazing low cost. LEARN HOW YOU CAN AVOID DIGGING, PUMPING AND MOVING. Write TODAY for complete details sent FREE! BURSON LABORATORIES, 951 Willard Ct., Dept. 810, Chicago 22, Ill.



Build the Best!

EASY TO ASSEMBLE **BOAT KITS**

NEW CATALOG
OVER 40 PAGES, INCLUDES ALL YOU NEED TO BUILD YOUR OWN
1-BOAT KITS—30 MODELS
2-MARINE HARDWARE
3-MARINE ENGINES
4-MARINE CONVERSIONS
5-PAINTS & COLOR CHARTS

All For Only 35c, SEND COIN TODAY

ROWBOATS
8-10-12-14 FT. **\$39 up**

OUTBOARDS
6 Models 12 to 16 FT.

INBOARDS & CABIN CRUISERS
16 TO 23 FT.

NEW 18 FT. OUTBOARD CABIN CRUISER
FAST VEE BOTTOM HULL— SPEEDS UP TO 25 M.P.H. — ROOMY CABIN, WITH TOILET, SLEEPS TWO

U-MAK-IT PRODUCTS 703R-WHITTIER ST. Bronx 59, N. Y. City

SAVE TIME AND TROUBLE ON THE ROAD

● Drive by HULL AUTO COMPASS—eliminate wrong turns, back-tracking, tension and fatigue. For proved accuracy, dependability, insist on a Hull—the one famous name in auto compasses. Write for local dealer's name, free literature.

"SURE DIRECTIONS WITHOUT STOPPING"

HULL MFG. CO.
P. O. Box 246-E1 Warren, Ohio

Beaconlite illuminated \$6.95
STREAMLINE standard (net list) \$4.95



ARE YOUR GUNS WORTH \$4.00?

That's all it costs for a whole year of the AMERICAN RIFLEMAN, big monthly magazine exclusively about guns. You'll get a real thrill from this grand old friend, long the favorite of shooter-sportsmen. Too, you'll get prompt notice

whenever your right to own and use your guns in sports is threatened by "anti-gun" legislation. And you can apply for membership in the National Rifle Association, with many extra benefits at no additional cost! Send only \$4.00 for an annual subscription now . . . and get a FREE copy of the NRA Manual HOW TO SHOOT A RIFLE (\$1 extra value), plus a confirming application for annual NRA membership.

NATIONAL RIFLE ASSOCIATION
1607-E Rhode Island Ave., N.W., Wash. 6, D. C.

BLACK EBONY SEAT COVERS

SWEEP TO SENSATIONAL NATIONAL POPULARITY



Salesmen jamming pockets with \$1000 bills

TAKING ORDERS FOR KEY EXPERTLY TAILORED AUTO SEAT COVERS

LOOK AT THESE FEATURES

- 7 Styles
- 7 Price Ranges
- A Complete Line of Sensational New Designs
- For All Cars — All Makes — Models — Years

7 STYLES

BIG SEASON Now Starting!

You've seen the huge color advertisements in Saturday Evening Post on the new seat cover sensation—miracle SARAN. Now it is available in the beautiful new BLACK EBONY pattern... with bold black and grey "Watermelon" stripes and with gleaming black quilted Sealtuft plastic trim. SARAN—the plastic, woven like cloth, that has the color permanently "locked" right into each thread! Car owners everywhere are demanding "Black Ebony". Now you can serve that eager demand at a fraction of the cost the customers expect to pay! Salesmen are making money hand over fist with this sensational new Key line. Take orders from car owners everywhere. Beat all competition with covers cut to accurate pat-

terns like the finest suit of clothes... Slick, smooth, wrinkle-free fit just like an original upholstery job!

RUSH NAME FOR FREE OUTFIT GIVE MAKE, YEAR AND MODEL OF YOUR CAR

Anyone working full or spare time can realize big money in this business. No need to search for prospects. Every car owner is one. Be first to cash in. Make year around STEADY PROFITS. Get your FREE Selling Kit at once for some real money. ACTUAL SEAT COVERS GIVEN FREE TO PRODUCERS FOR OWN USE! Write for full details.

KEY PRODUCTS CORP.
Dept. 61
800 N. CLARK, CHICAGO 10, ILL.

SAVE 50% - THOUSANDS HAVE ASSEMBLED

\$42^{UP} PACKAGED BOAT KITS

27 MODELS

Dinghies, skiffs, racers, inboards, outboards and cruisers. Assemble your own boat, it's easy, it's fun! All parts pre-cut or pre-

fabricated from finest materials. Get all the facts from our big 24 page catalog. See how Packaged Boats are built, how they perform, how exclusive construction features make assembly easy. Includes specifications, performance data plus hardware and paints.

SEND 25¢ for NEW 24 PAGE CATALOG
CUSTOM-CRAFT - DEPT. 5 - BUFFALO 7, N. Y.

BOAT PLANS PATTERNS

► Over 50 modern plans and full size patterns. Racing classes, cruisers, inboards, outboards, sail boats. By famous designers. 6' to 30'. DESIGN CATALOG 35¢. Design Catalog and boat building handbook, \$1.00

MARINE MART - DEPT 5 - BUFFALO 7, N. Y.

BRITISH COMMANDO KNIFE

\$3.00

postpaid, complete with original leather sheath (for belt and boot)



Official Issue
"FAIRBAIRN FIGHTING KNIFE"

Ideal gift for the service man. Collector's item. Authentic World War II souvenir. Each knife marked, "Made in Sheffield, England". The actual knife used by British Commandos and U. S. Rangers in hand-to-hand combat. Blade, 7". Overall, 12". The most beautiful knife of World War II. Brand new original blueing may be used as a letter opener. Send Check, Cash \$3.00 or Money order. Postpaid.

For domestic and overseas airmail, add 80c per knife. Calif. residents add 3% state tax. Dealers inquire.

PASADENA FIREARMS CO. Dept. PS-1
972 East Colorado Street Pasadena 1, California

WHAM-O SPORTSMAN*

\$1.25 POSTPAID 45-LB. PULL!

HITS LIKE A .22 RIFLE—KILLS RABBITS, SQUIRRELS. Powerful, silent, accurate. For hunting, target, routing pests. Sportsman's choice sold world over!

HUNTING SLINGSHOT

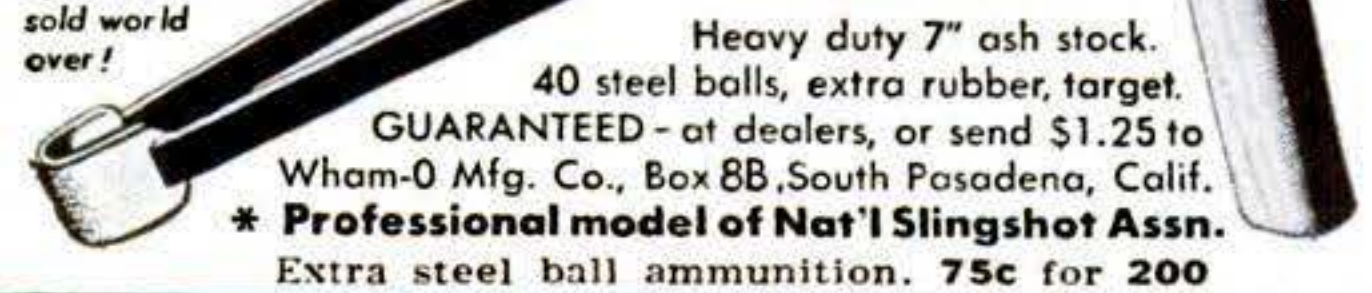

Heavy duty 7" ash stock. 40 steel balls, extra rubber, target.

GUARANTEED—at dealers, or send \$1.25 to Wham-O Mfg. Co., Box 88, South Pasadena, Calif.

* Professional model of Nat'l Slingshot Assn. Extra steel ball ammunition. 75c for 200



QUICK EASY!

Sponge Cleaning Cloth AUTO WASHER

Auto washed in 1/2 time. PRESTO! Dust, grease, dirt, and grime disappear like magic. Leaves finish clear, lustrous. Autogleams like a mirror.

SAMPLES TO INTRODUCE
Sample offer sent immediately to all who send name at once. Hurry, postal will do. **SEND NO MONEY—Just your name.** KRISTEE CO., Dept. 710, Akron 8, Ohio

GROW MINIATURE TREES

FOR PROFIT & PLEASURE



Fabulous Money—Real Fun! Grow genuine live dwarf (Ming) trees. A terrific new business and hobby. Astounding details Free. Write —

DWARF TREES, Dept. 12
P. O. Box 355 • Briggs Station
Los Angeles 48, California



LIGHTWEIGHT \$370.00

(Fed. tax paid, at factory)

9.5 hp. 4-cycle. 3-speed. Foot-shift. Over 70 miles per gal. Over 60 m.p.h. Write for free circular.

MUSTANG, Dept. PS
635 W. Colorado, Glendale 4, Calif.



100% PROTECTION

TEAR GAS

A REAL SURE-FIRE SELLER! THUGS AND THIEVES BEWARE!

Here is a tear gas pencil gun which discharges smothering clouds of tear gas to instantly stop, stun and incapacitate the most vicious man or beast. A safe and effective substitute for dangerous firearms. No permanent injury. Needed in Stores, Banks, Autos and Homes, everywhere to protect Life and Property. No skill required. Handle our tear gas as a side line and you'll soon give it full time. For a quick start send \$4.25 for complete demonstrator outfit consisting of an Automatic Pencil Gun with 10 demonstrators and 3 powerful Tear Gas cartridges fully guaranteed. Many thousands now in use. Order your outfit today. Not sold to minors.

Hagen Supply Corp. Dept. A501 St. Paul 4, Minn.

STORM WINDOWS \$1.00 ea.

- Put Them Up Yourself in Minutes!
- Save \$100 or More!
- Pay for Themselves in Fuel Savings!
- Tested on 500,000 Windows!

No need to buy expensive glass storm windows! Keep warm and save fuel this winter with these transparent storm windows! All you need is a hammer and scissors—and you can put them up yourself! Made of strong, transparent Bakelite Vinylite. Won't tear, shatter or rattle. You get a 36"x72" sheet of vinylite, framing strips, tacks, plus easy directions. Guaranteed waterproof, windproof, stormproof and non-inflammable. Cleans easily with a damp cloth. Only \$1.00 plus 10c postage each. Get one for each window in your home! Money back in 10 days if not delighted.



DAMAR CO., 602 Damar Bldg., Treat Pl., Newark 2, N. J.

BUILD THIS STREAMLINED, TELESCOPING COMSTOCK TRAILER

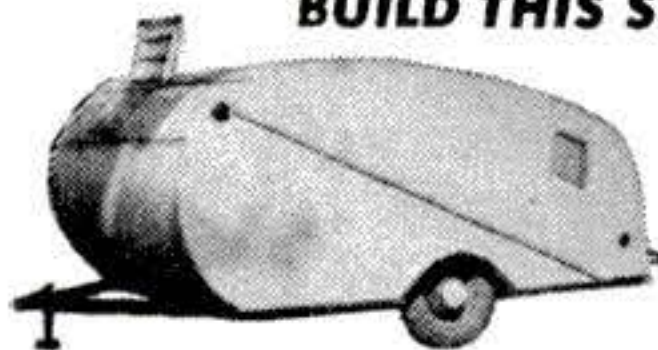

Complete Blueprint and Instructions ONLY \$2.00

Enjoy camping, hunting, fishing or touring with all the luxury of a big trailer in this compact beauty. For information and pictures send 10c to:

Thos. Comstock, Dept. R, 820 N. 17th St., Parsons, Kansas.

HIGH POWER TELESCOPE

60 POWER ALUMINUM TUBES OPENS TO 33"

Variable Power Adjustable to 15X, 30X, and 60X.

\$5.95



Leather Case Included

5 Sections, 4 Ground & Polished Lenses. Also used as 50X Microscope. Ready to use, only \$5.95. POSTPAID.

CRITERION CO.

438 ASYLUM ST. HARTFORD 3, CONN.

WORLD'S FINEST

ROSE BOOK FREE

New 48-page catalog in FULL COLOR—shows hundreds of famous roses and perennials—all guaranteed to live and bloom in your garden. Planting hints—many money-saving offers. Write for your free copy today!

JACKSON & PERKINS CO.
(World's Largest Rose Growers)

51 Rose Lane, Newark, NEW YORK



LAWN ORNAMENT-NOVELTY PATTERNS

28 Lawn Ornament Patterns, 25c. Other patterns: 15-20" high; Dutch Girl, Dutch Boy, Pirate, Bull Terrier, Mexican Girl, Mexican Boy, Dwarf, Penguin, Flower Girl, 10c each. 25 Novelty Patterns, 30c. All 62 Full Size Patterns, \$1.00 Postpaid.



FLYING DUCK

Wind revolves wings. Realistic appearance. Pattern, instructions and wing Pinion Kit; brass bearing, steel shaft, wing lugs, bolts, nuts and washers, 50c. Pattern and instructions without kit, 25c. Postpaid.



STROTHER PATTERN SERVICE
Dept. 7-CK Box 128 Bellington, W. Va.

ELECTRIC MOTOR BARGAINS!



1/2 HP	3450 RPM	19 ⁷⁵	3/4 HP	3450 RPM	32 ⁰⁰
1 HP	3450 RPM	39 ⁰⁰	1 1/2 HP	3450 RPM	47 ⁵⁰

Every Motor Fully Guaranteed

Heavy Duty, Repulsion Induction and Capacitor Types, 110-220 Volts, 60-cycle, Single-phase. Standard Makes (G. E., Wagner, Le-land, Westinghouse, etc.). Rush your order TODAY—large stock of motors—1 & 3 phase. 32-v. direct current bargains. Prices f.o.b.

ROBERTS ELECTRIC CO., 849 W. Grand, Dept. 20, Chicago

THEY

GO

BETTER TOGETHER

Pyroil and WINTER OIL

When you change to winter oil—remember to add Pyroil—and forget a lot of winter-time driving headaches. In cold weather, you need low viscosity oil to help you get started—but you need the extra protection of PYROIL to keep you GOING. Winter Oil quickly drains off piston rings and cylinder walls, exposing them to rust and corrosion caused by dampness and cold.

Pyroil, has the extraordinary property of making oil (yes, low viscosity oil, too) protect these important engine parts with a blanket of oil at all times. Pyroil prevents damaging "dry starts", Pyroil permits oil rings and piston rings to work freely without "pumping" due to gum and sludge.

Pyroil and winter oil GO better together—you'll GO better, longer, at less maintenance cost, with Pyroil.

When you add winter oil—add Pyroil—add miles to your car.

Pyroil for Aircraft Engines

Use Aircraft Pyroil B for lubricating oil, Aircraft Pyroil A for gasoline.

GIVEN!

An attractive Pyroil metal savings bank—takes coins up to 50c pieces. MOTORISTS, it's yours for the asking—sent postage paid.



Manufactured and Guaranteed by Pyroil Company, 603 Main Street, La Crosse, Wisconsin

Canadian Distributors: Central Purchasing Agencies, Ltd., Toronto, Ontario

PYROIL COMPANY
603 Main St., La Crosse, Wisconsin

I want my car to last and run properly. Please tell me more about Pyroil and how it can accomplish this for me.

Name _____

Address _____

City or Town _____ State _____



make your WORKSHOP PAY



make your **AMMUNITION**,
safely and easily.

Savings per 100 rounds: (examples)
30/06 cal. \$13.80; .22 Hornet \$6.40
45 Automatic \$6.23;
Shotgun Shells \$4.48

Full details and instructions in
the illustrated Ideal Reloading
Hand Book, 184 pages . . . 75¢

The *Lyman Gun Sight Corp.*
MIDDLEFIELD, CONN.



How to Always Have **HOT WATER**

Make Your Own Automatic Electric Water Heater **\$19.95**
now for only

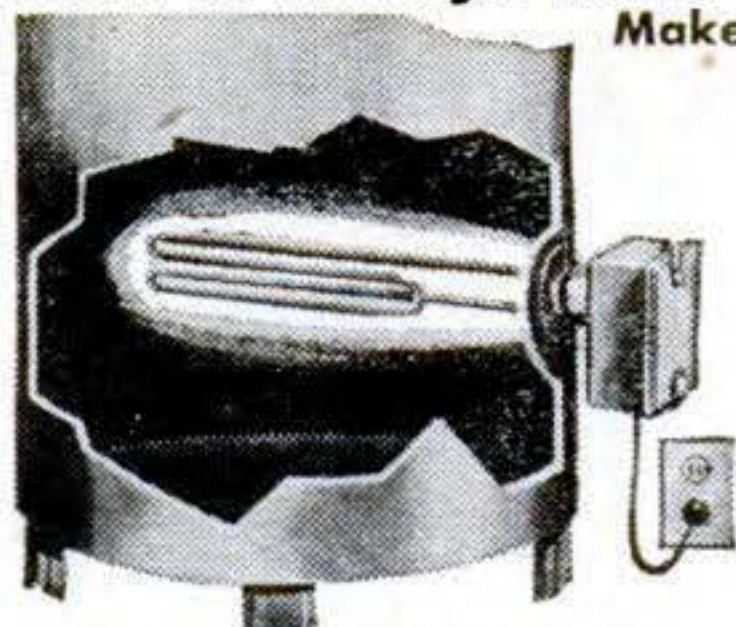

Install in 5 min. No disturbing
or draining of tank or pipes

Why suffer without hot water? Enjoy lots of it to wash, bathe, shave. Heater keeps water **HOT** in your present tank. Turns **ON** when needed—shuts **OFF** when water is heated. No flue, dirt, fire!

Ideal for 30-gal. tanks. Heater screws into any size boiler tap as shown. Plugs into outlet . . . 1320 w. 110 v. AC. (also 2000 w. 220 v. model for BX cable \$19.95) . . . works automatically thereafter. Temperature adjustable between 120 to 180 degrees. Replaces coal, oil, gas in home, store, summer cottage, green house, farm, barn, stock tank, poultry scalding, factory. Uses only 1 1/2 to 1 3/4 c electricity per gallon hot water. Why burn expensive main furnace unit for hot water? Send check or M.O. NOW: save postage charges. **ORDER NOW . . . TODAY.** Money back in 10 days if not delighted.

COLLOID EQUIPMENT CO., INC. Dept. PS-1, 50 Church Street, New York 7, N. Y.

**NEW!
CHEAP!**

OIL BURNER

SWEEPING THE COUNTRY!

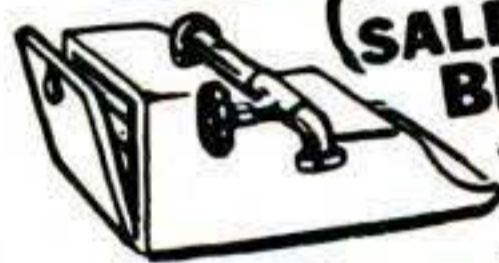

**SALESMEN
BIG MONEY**

**SLIPS INTO ANY COAL
RANGE, STOVE OR FURNACE**

Amazing quick, intense heat. By finger-tip control. Cheaper than coal. No more shoveling coal or ashes. **SENT ON TRIAL.** Prove it pays for itself quickly by what it saves. Big bonus for testing. We'll

let you try one in your own home for one month. Write for details today. **NORTHWEST MFG. CO., 361-A Main, Mitchell, S. Dak.**

COLT FRONTIER REVOLVERS



**"LOW"
PRICES**

ALL NEW CATALOG #2

Over **ONE HUNDRED COLT FRONTIER** Model Revolvers in Stock. Complete line of Holsters, Parts, Ammo., etc.

SEND 50c FOR BEAUTIFUL ALL NEW UP-TO-DATE CATALOG. Price of Catalog applied on first purchase

HY HUNTER, 5666 W. 3rd St., Dept. O, Los Angeles 36, Calif.

TOP transportation buy of the CENTURY

**Cushman
EAGLE**



**75 miles per gal.
50 miles per hour**

Total
operating
cost

3/4¢ per
mile

The great New Cushman "EAGLE" combines super riding comfort, economy, outstanding performance and unusual power. Ride the "EAGLE" everywhere. It's easy to park, easy to operate, ideal in traffic. Be money and time ahead with the "EAGLE." **GO CUSHMAN.**

Write today for Free Illustrated literature.
See your nearest Cushman dealer.

CUSHMAN MOTOR WORKS, Inc
913 NO. 21 ST., LINCOLN, NEBRASKA

World's Fastest Boats!



Build your own high speed racing boat from a Champion plan! Send 25c for catalogue containing pictures and description of 18 models. Hydroplanes, Utilities and 3 Points. 6 to 20 ft. lengths. **CHAMPION BOATS, 1524 W. 15th St., Long Beach 13, Calif. Dept. 18-M**



**THIS
FIGHT
IS YOURS**

JOIN THE MARCH OF DIMES





MARFAK MADE HIS CAR RIDE SO CUSHIONY HE'S SPOILED

This winter, get longer lasting lubrication protection for your car's chassis. Get *Marfak* lubrication. It lasts for 1,000 miles or more! *Marfak* guards against winter's slush and snow—it resists wash-out. Specially made to resist jar-out and squeeze-out, too. Get "cushiony" riding that *lasts*. For *Marfak* lubrication see your Texaco Dealer, *the best friend your car ever had*.



Faithfully yours
50
 for Fifty Years

THE TEXAS COMPANY
TEXACO DEALERS IN ALL 48 STATES

Texaco Products are also distributed in Canada and in Latin America



TUNE IN . . . TEXACO STAR THEATER starring MILTON BERLE on television every Tuesday night.
METROPOLITAN OPERA radio broadcasts every Saturday afternoon. See newspaper for time and station.

JANUARY 1952 79

Bite's Out



*the
National
Joy Smoke*

Pleasure's In



— AND THERE'S MORE TOBACCO IN EVERY TIN!

Prince Albert's patented* "no-bite" process means real smoking comfort

... Prince Albert is made to give you more smoking enjoyment than any other tobacco! P.A. is specially treated to insure against tongue bite. Rich-tasting and mild... No wonder it's the big favorite with roll-your-own smokers and pipe smokers alike!

*Process patented July 30, 1907

MORE MEN SMOKE

Prince Albert

THAN ANY OTHER TOBACCO



R. J. Reynolds
Tobacco Company
Winston-Salem, N. C.

Death Designed This Fire Truck

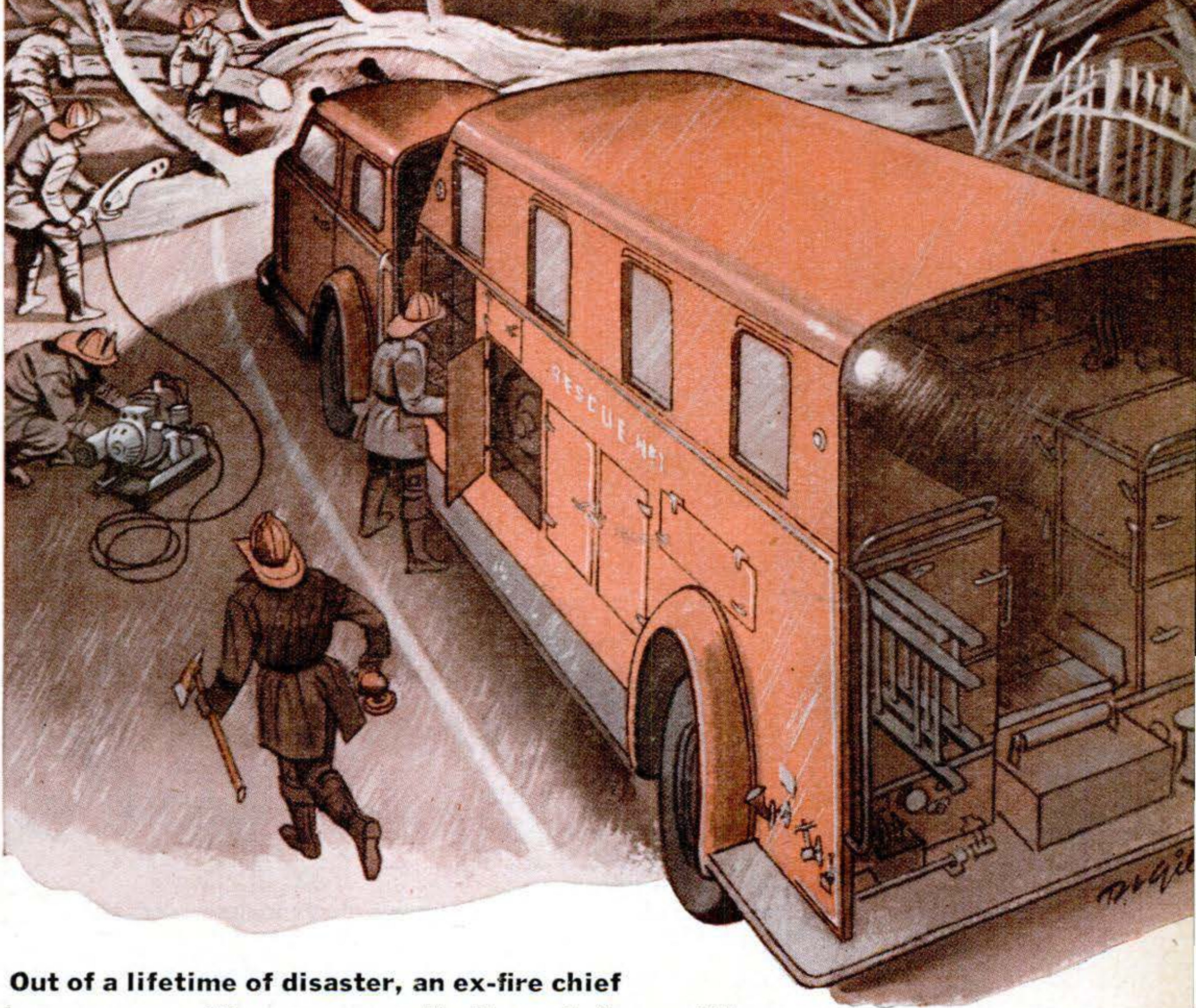

Out of a lifetime of disaster, an ex-fire chief has come up with a rescue car that's ready for anything.

By Gardner Soule

FORTY-TWO years of watching people die and property turn to ashes taught Charles A. McGinley that a really good fire department is one that is prepared for *every* kind of trouble. As a fireman and, for 22 years, as chief of the fire department of East Orange, N. J., he learned a great deal about how to cheat both death and

destruction. What he learned has been built into an emergency truck, called Rescue No. 1, that's a trouble-shooting masterpiece. It's ready for anything, from explosions to heart attacks. Custom-built for East Orange, there's literally nothing like it in the world.

McGinley, now 66 and retired, no longer is on call when disaster occurs. Rescue No. 1, built from plans he helped prepare be-

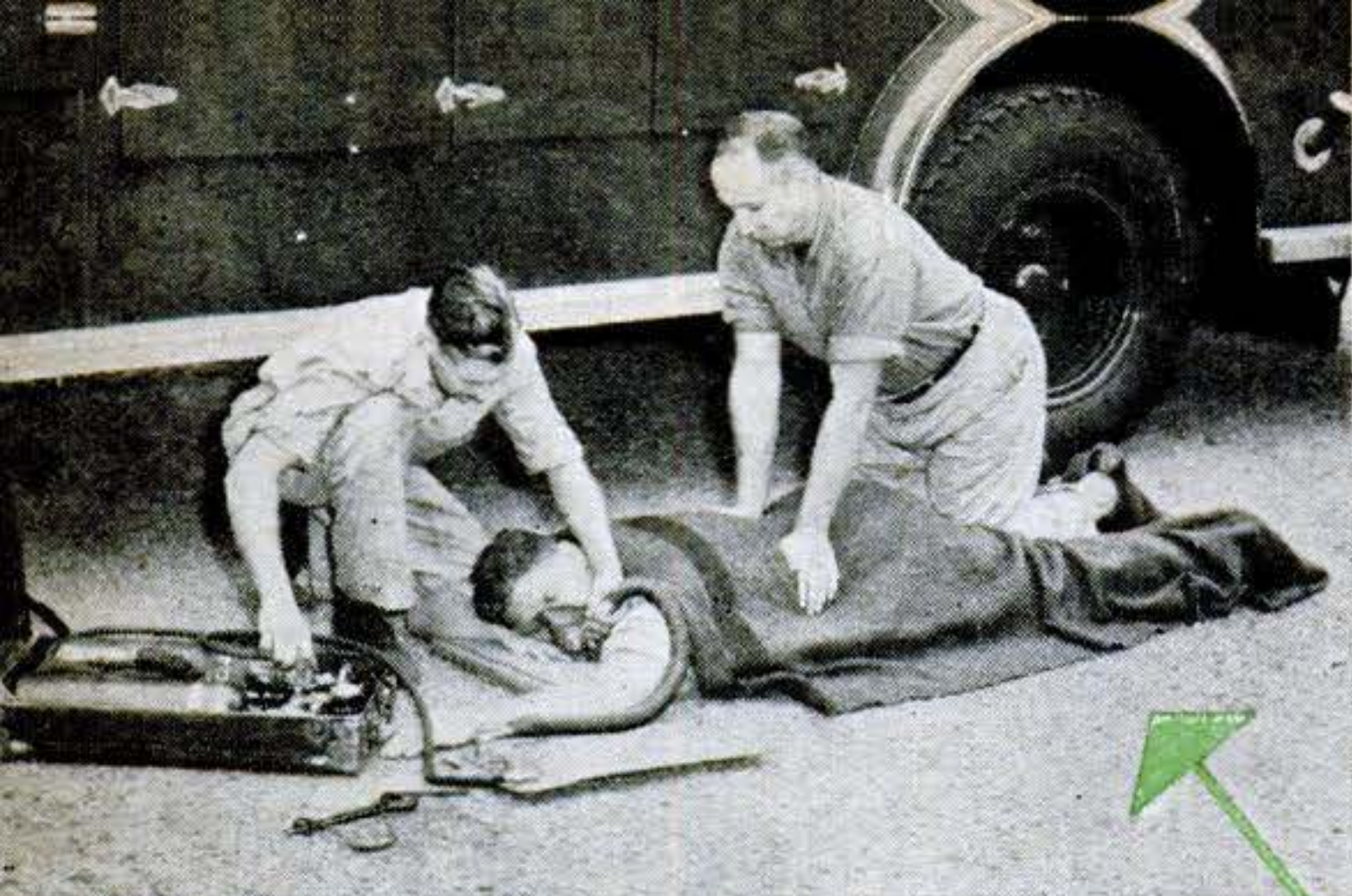

ADMINISTERING OXYGEN is most frequent emergency job for crew of Rescue No. 1. Truck carries several inhalators, a large oxygen supply, foam-rubber mattress, blankets.

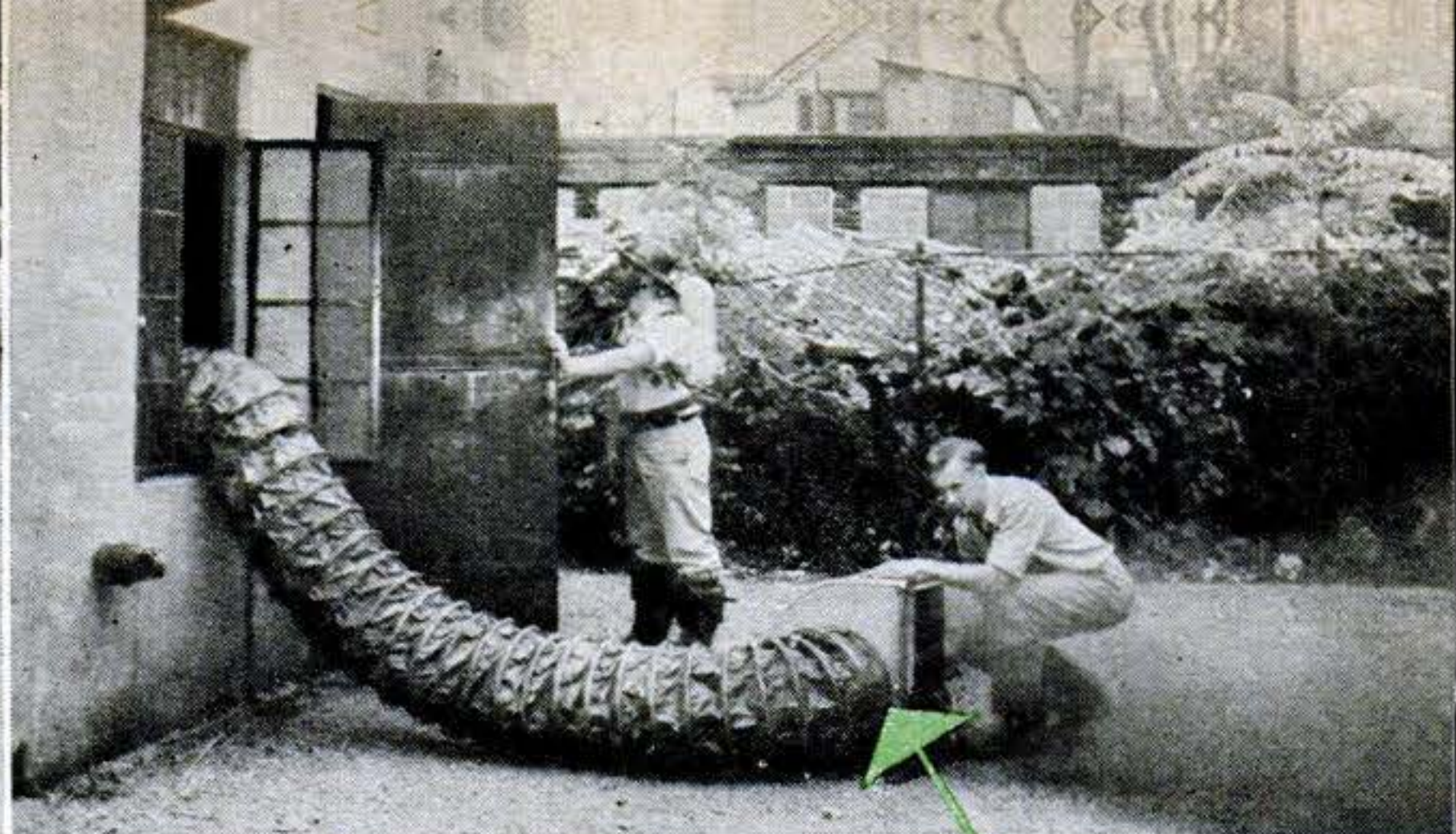

SMOKE-EATING CATERPILLAR, a new device called an ejector, clears air in seconds so firemen can enter a burning building. It is an exhaust fan on a bellows-like tube.



PAVEMENT BREAKER, or air hammer, lets rescuers punch through reinforced-concrete floors in commercial buildings to ventilate basements. Portable generator runs it.

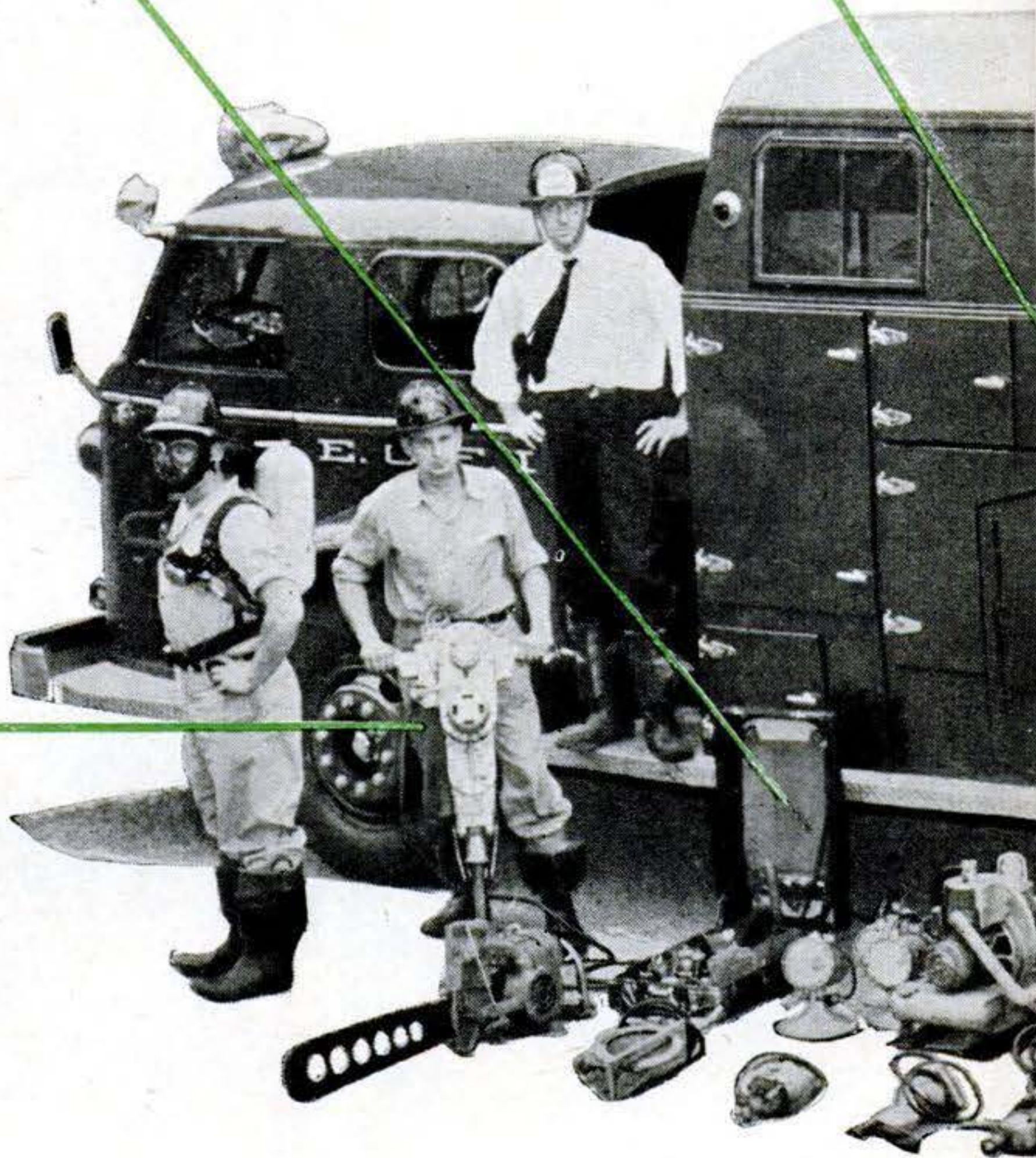

PS PHOTOS BY HUBERT LUCKETT

fore he left the force, not only answered every fire alarm in East Orange during 1951, the first full year it was in operation, but responded to hundreds of emergency calls of other kinds. It has three captains and three crews (five men each), because it is on duty 24 hours a day. It has become a monument to McGinley's planning.

Throughout his career, which began in the days when fire horses used to wake him up at five o'clock in the morning by pounding on their stalls for breakfast, McGinley was always trying to find better ways to fight fires and help people in trouble. It's

no wonder that Rescue No. 1, the product of this experience, is called out as often as nine times a day by East Orange citizens.

Ten years ago McGinley arrived at an apartment-house fire to find 51 gas inlets ablaze. The meters had melted off. The gas pressure was terrific and there was no time to put out 51 fires and plug each gas line even if the plugs would hold under the high pressure. "Besides," McGinley recalls, "you couldn't get near 'em." He had provided a special gas-shutoff wrench, never used before, for such an occasion. With it, one of his men stopped the gas as

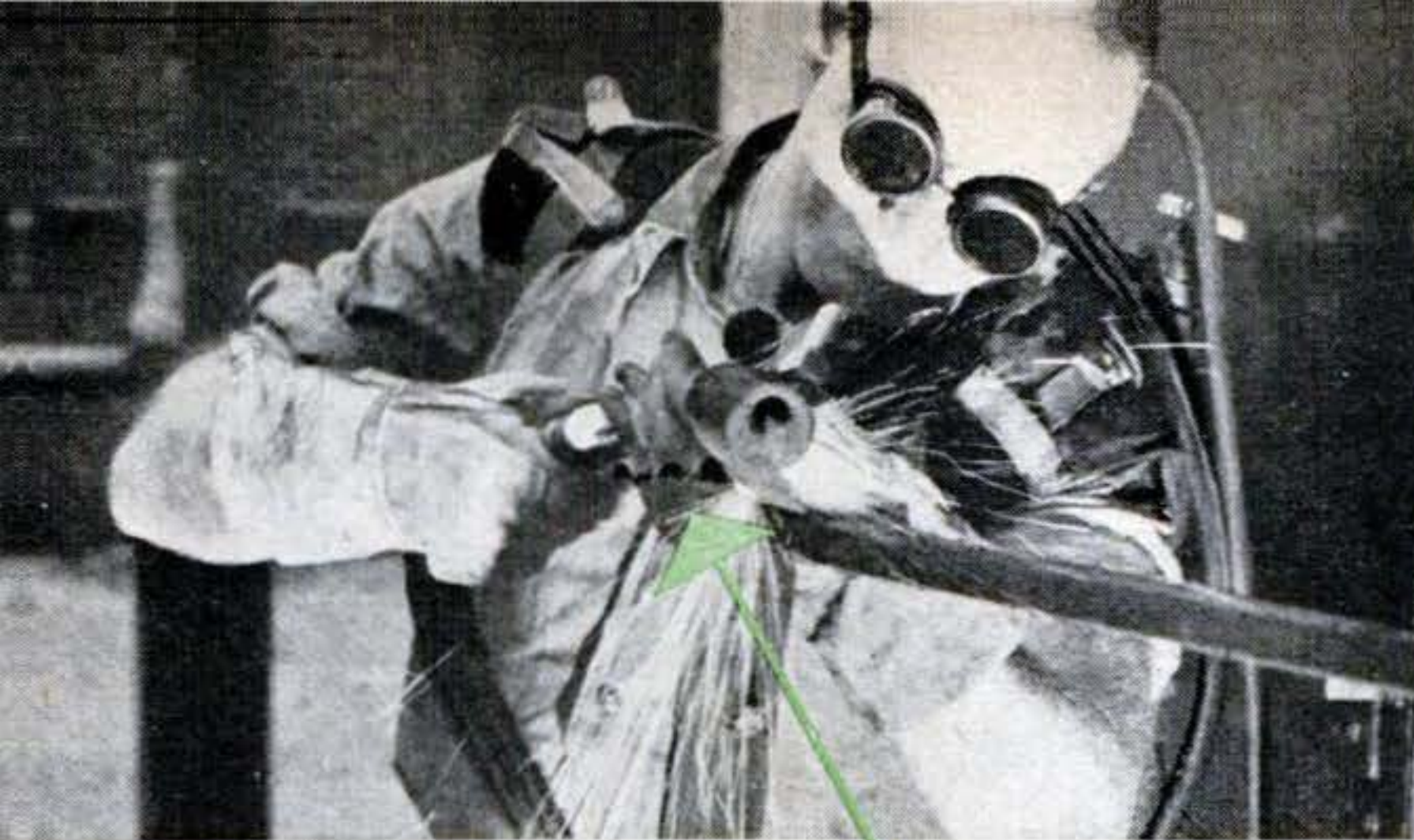

OXYACETYLENE TORCH is used to free people caught between elevators and shafts and to cut steel girders. Danger of igniting gasoline bars its use in auto-wreck rescues.

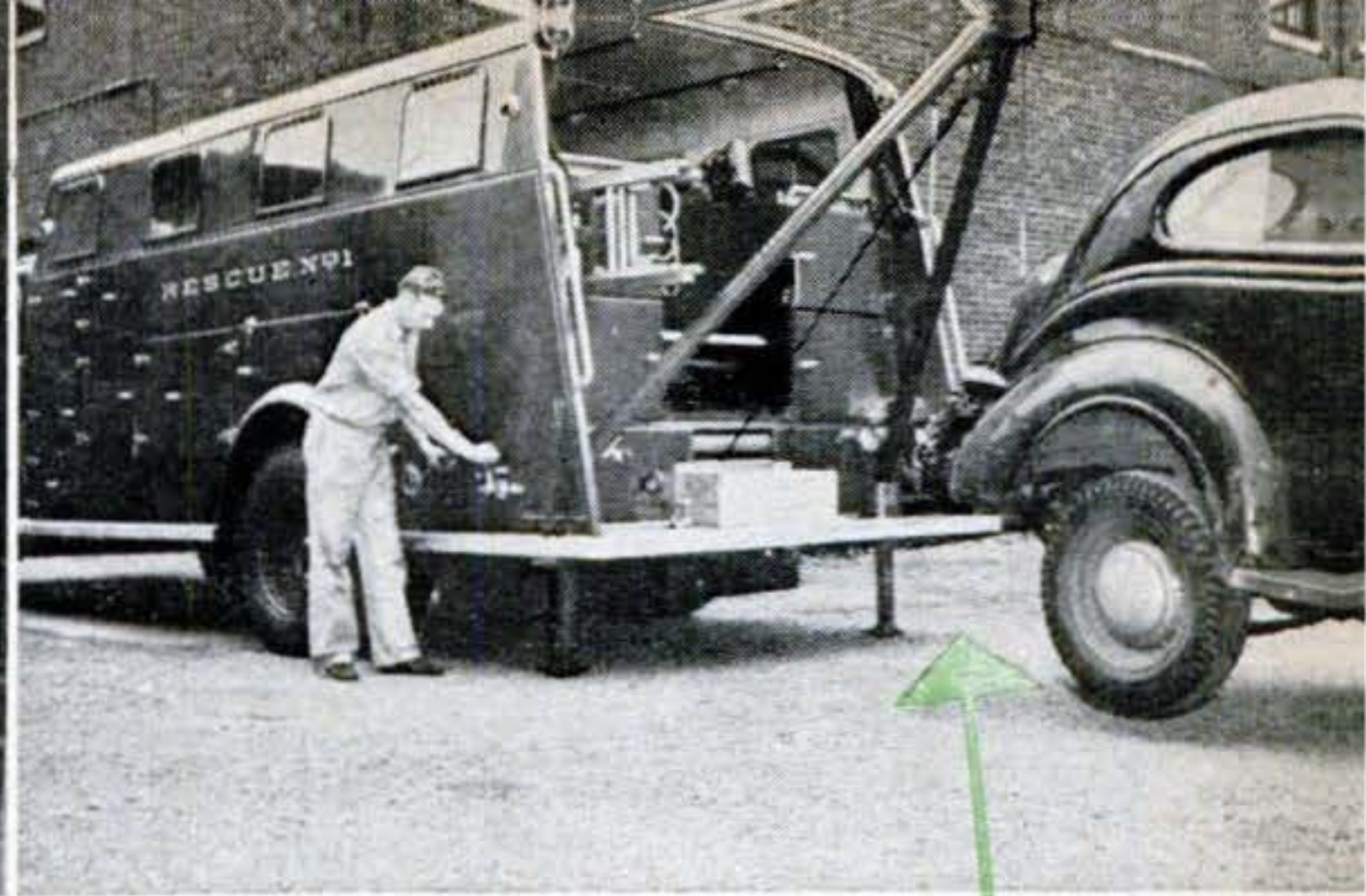

RUGGED HOIST, carried inside truck and set up at emergency scene, lifts weights off people pinned under them. Heavy jacks let down from truck's rear end take the load.

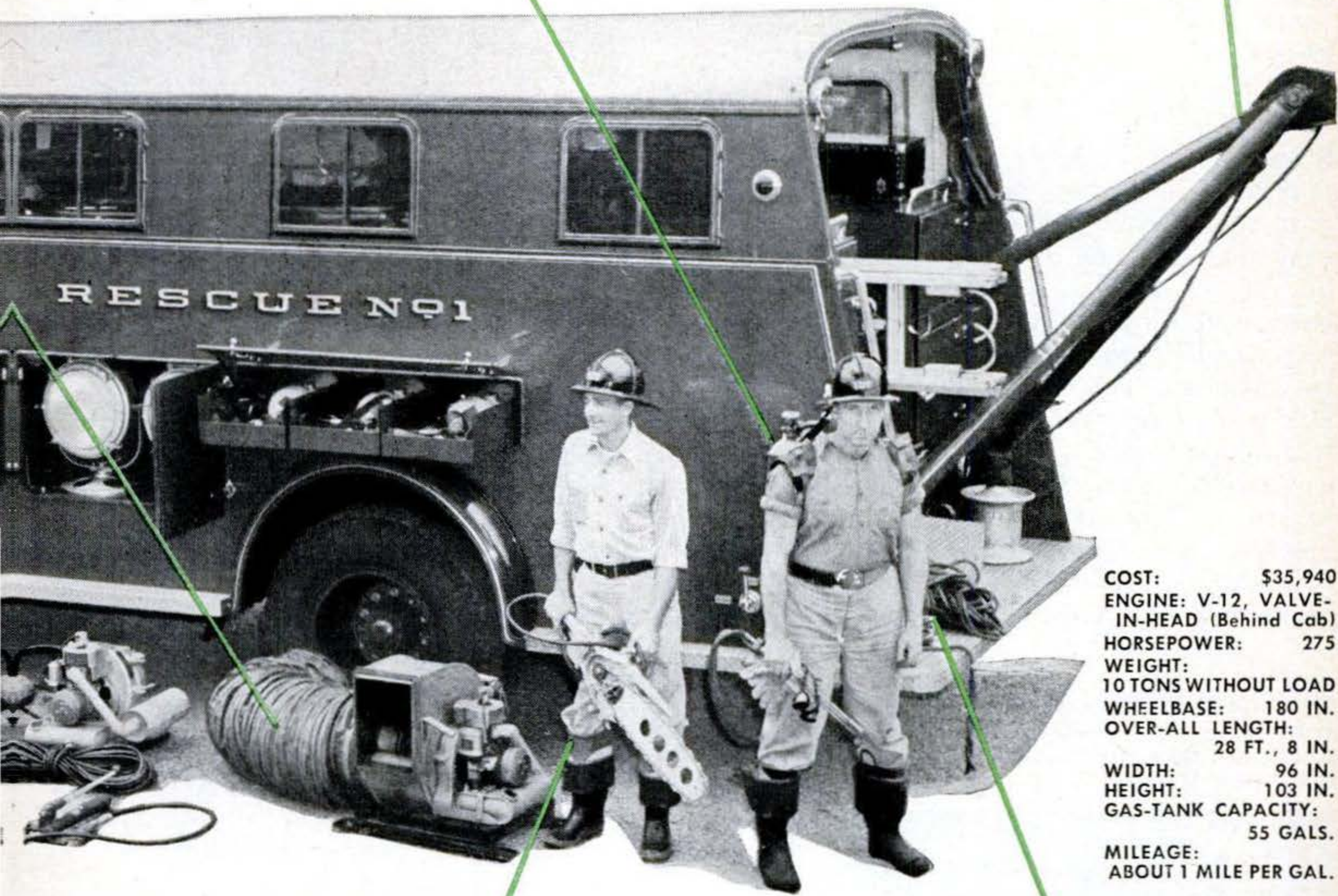

COST: \$35,940
ENGINE: V-12, VALVE-IN-HEAD (Behind Cab)
HORSEPOWER: 275
WEIGHT: 10 TONS WITHOUT LOAD
WHEELBASE: 180 IN.
OVER-ALL LENGTH: 28 FT., 8 IN.
WIDTH: 96 IN.
HEIGHT: 103 IN.
GAS-TANK CAPACITY: 55 GALS.
MILEAGE: ABOUT 1 MILE PER GAL.

CHAINSAW helps clear streets and free cars of fallen branches, trees, poles. Truck carries several generators, one of which provides either AC or DC for power tools.

MAN ENTERING SEWER wears a Scott Air-Pack, enabling him to breathe anywhere. Sidewalk tank supplies clean air. Rope, attached to his body harness, can be used to haul him out.

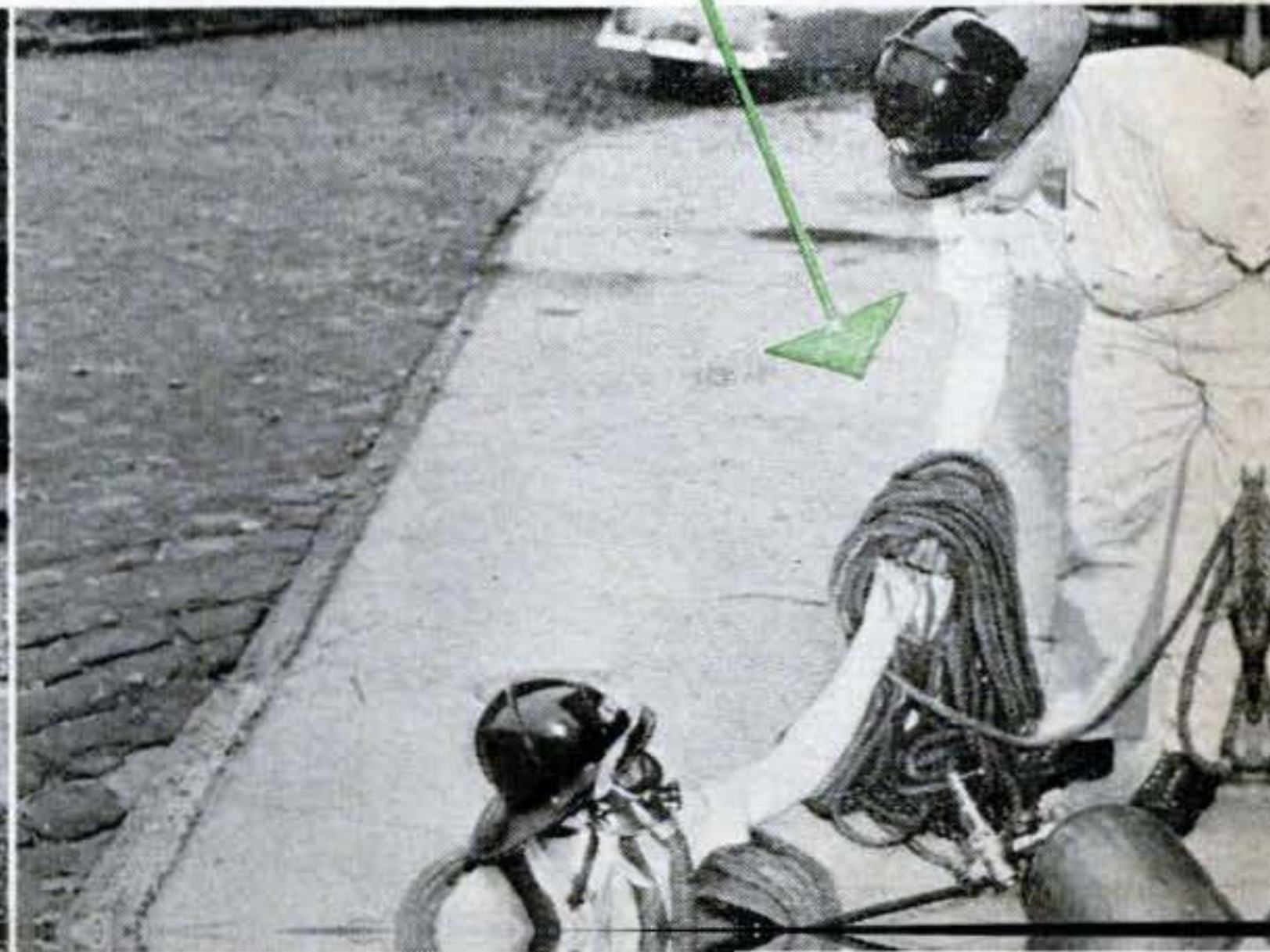
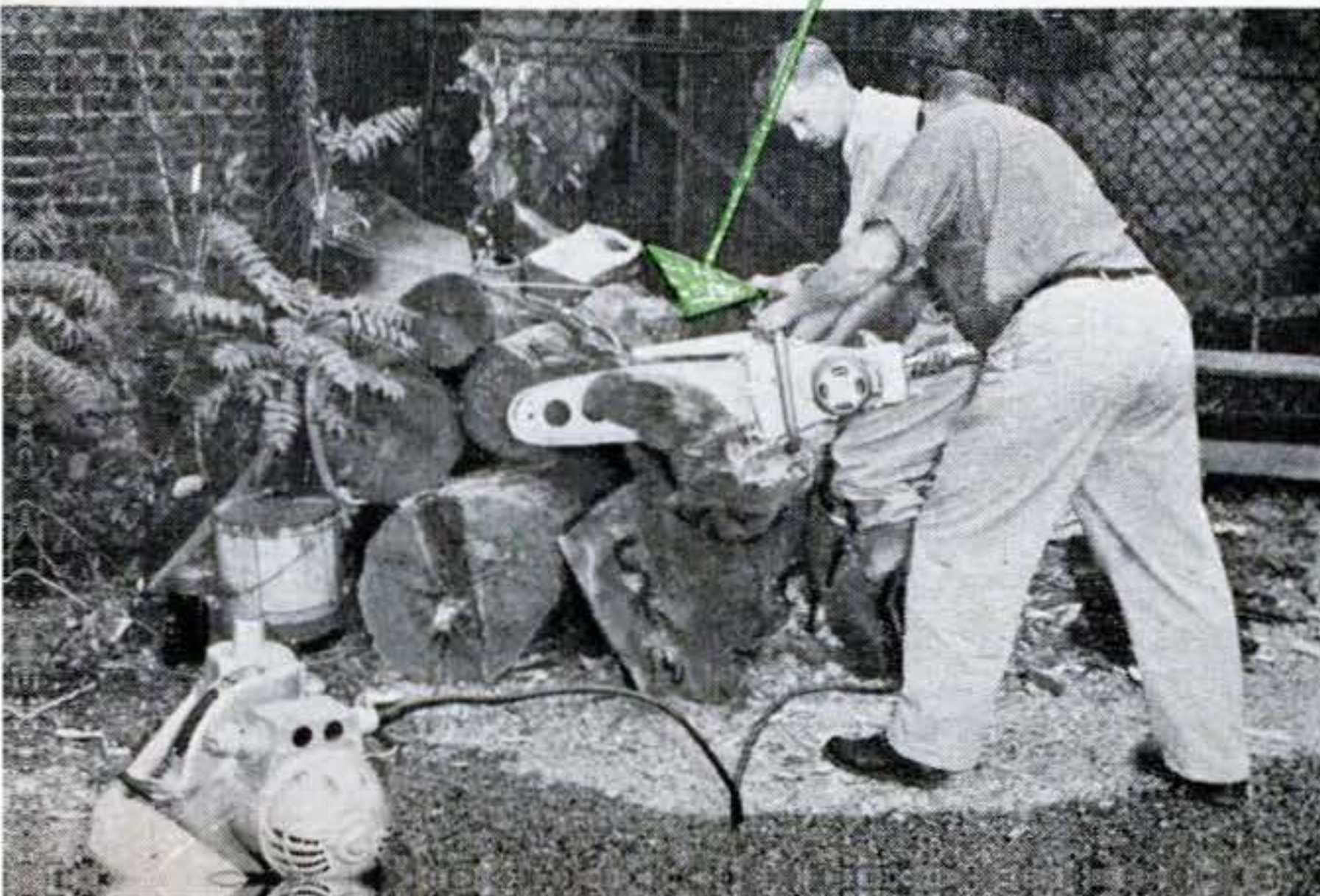

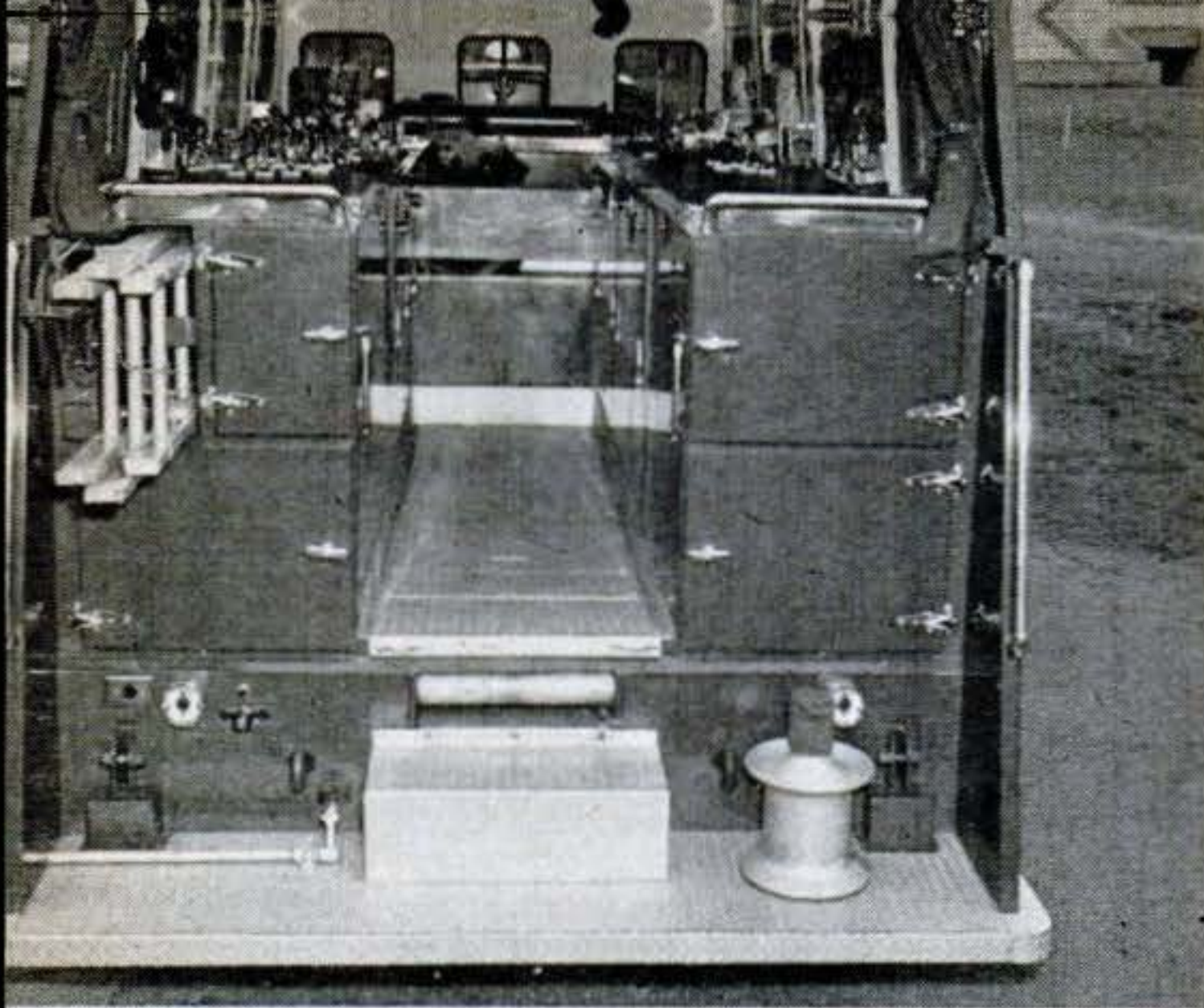

INSIDE RESCUE NO. 1, it's as trim as a bank vault. Ladders, drugs (to be used only at a doctor's call), stretchers, gas masks and radio are here. Two crew members ride with them.

it left the street main. Today the wrench is instantly available aboard Rescue No. 1.

In 1938 the Northeast was hit by a hurricane that was one of the roughest storms in history. In East Orange hundreds of trees were down. "All of us," McGinley says, "had to get out and use handsaws to cut them up. This took a week. We probably could have done it in a day and a half with power saws." Today Rescue No. 1 carries chainsaws, circular saws and power hacksaws. When a recent local windstorm blocked streets and tossed trees onto parked cars, the truck and its crew cleared things up in six hours. Power saws sliced through

EX-CHIEF MCGINLEY can now enjoy his fireside, content in the knowledge that all he learned about fighting disasters is being applied every time that Rescue No. 1 answers a call.



some big trees in a mere 15 minutes' time.

Five years ago McGinley and his men fought a fire in the basement of a garage. Thousands of tires were burning. The entrance, a ramp, was blocked by heat and smoke. No fireman could enter. With compressed-air hammers, the men made a sieve of the concrete floor above the garage basement and poured water through the holes. That quenched the fire before it could spread.

"That was proof to me," McGinley says, "that every fire department needs an air hammer. If you only use it once in a lifetime, it saves your skin." Rescue No. 1 has an air hammer.

Firemen Are First Aiders, Too

Over the years McGinley saw people die—from heart attacks, gas asphyxiation, electric shock—for lack of oxygen. "Too few fire departments have enough oxygen at hand," he says. "We keep a 24-hour supply." Rescue No. 1 carries a dozen bottles of this lifesaver. More is in the basement at headquarters. If No. 1 runs out, the chief's car races back to headquarters for replacements. In 1951, East Orange's new emergency truck answered more than 200 calls when oxygen was needed.

McGinley once saw a man screaming with pain from a mangled and broken knee after his car had hit another head on. An untrained bystander tried to move the man and in doing so hurt him far worse and made his injury more serious. McGinley resolved then that his rescue squad would be experts. "Today," he says, "they all have first-aid certificates from the Red Cross." Rescue No. 1 carries a supply of bandages, splints, tourniquets, blankets, stretchers and a mattress. The men drill continually in the use of this equipment.

Stuck Elevators Are a Specialty

There weren't many elevators when McGinley started as a fireman. As buildings grew, the number of elevators increased, and so did the number of cases of people getting stuck in them. Today East Orange's rescue-squad men are among the few in the country who can move an elevator by hand, from the top of the shaft, and bring it in front of a door. If someone is trapped between the elevator and the shaft wall, they have cutting tools, including an oxy-acetylene torch, to get him out.

[Continued on page 270]



Skiers Train in Wind Tunnel

WITH plenty of breeze but no snow at all, these crack British skiers are practicing inside a Royal Air Force wind tunnel. The champion skiers, who will go to Oslo next month to represent Great Britain in the 1952 Winter Olympics, are also helping the RAF study the relation between body angle and wind resistance.

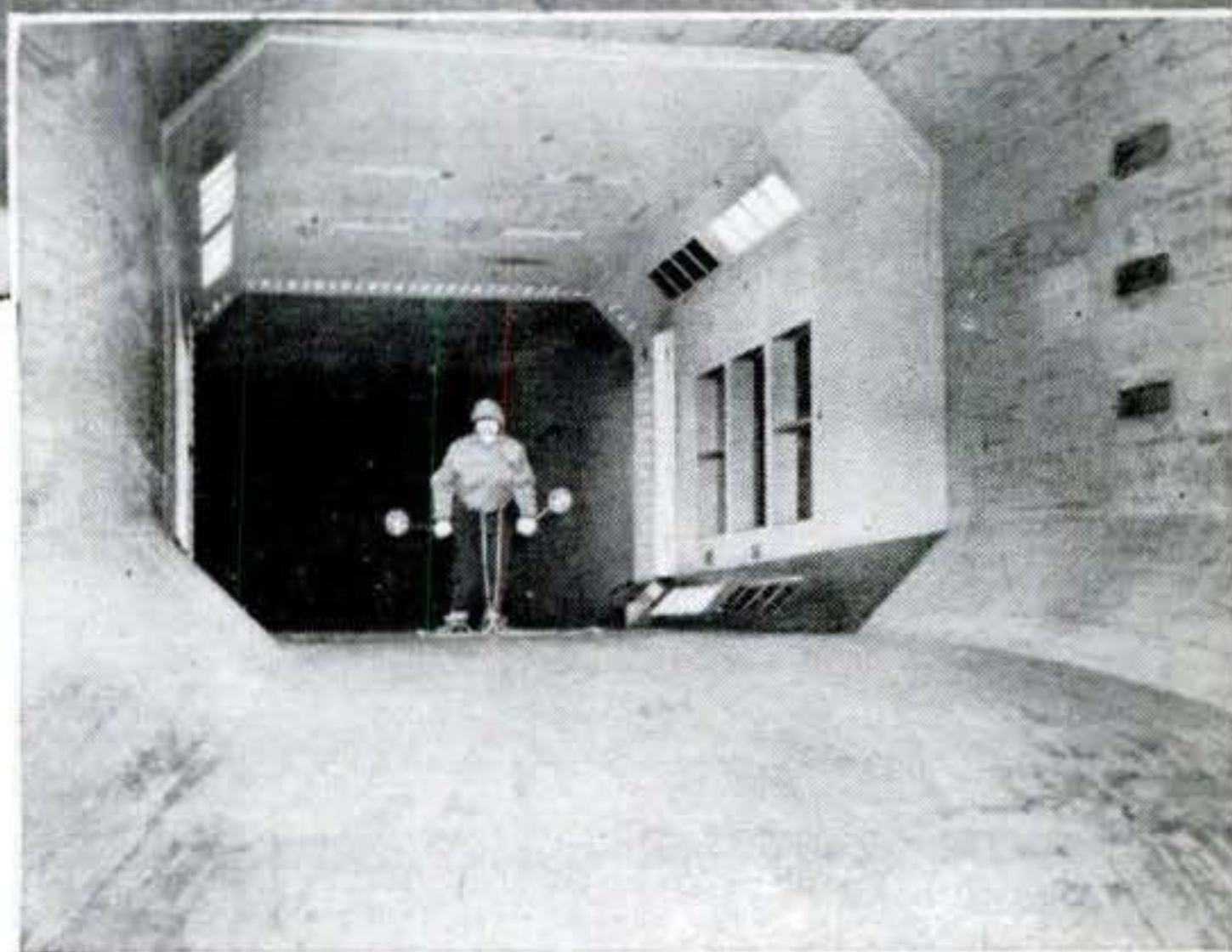

Attack Bomber Is 12 Planes in One

THE latest Douglas Skyraider, primarily a carrier-based bomber, can rapidly be made over into any one of 11 other types of plane. Packaged conversion kits come with its "universal chassis," enabling it quickly to become a flying ambulance, a photo plane, an anti-submarine hunter-killer, a passenger transport or whatever is needed.



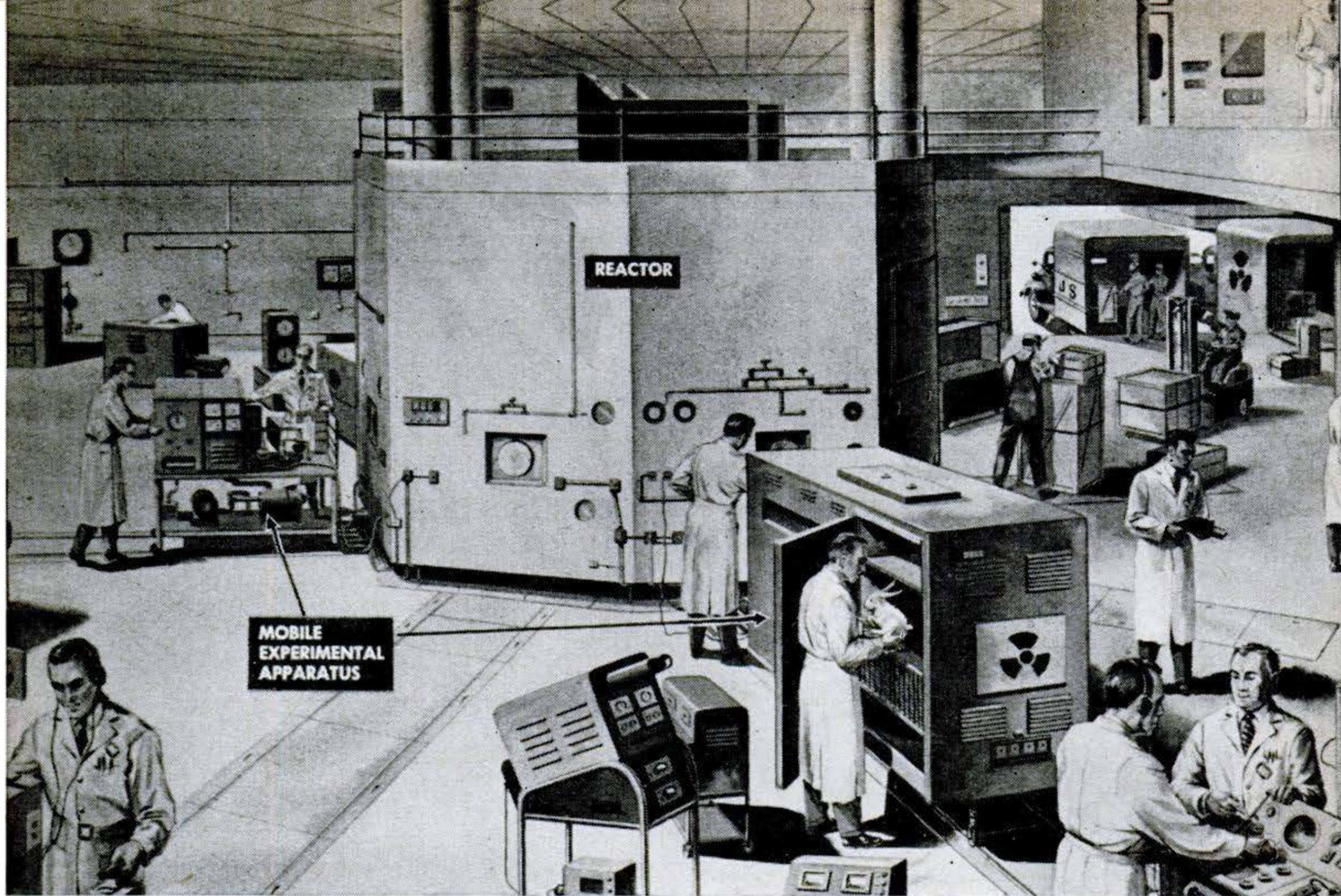

How baby pile might be set up in college or industrial laboratory is sketched above. Operator

Baby Atom Pile to Run 10 Years on Uranium Pill

PARTS for the first "popular-model" atomic furnace, a 160-kilowatt midget called the Low Power Research Reactor, are already being tested. Like Government piles 100 times its size, it will permit atomic experiments and manufacture valuable radioactive isotopes—including those too short-lived to be shipped from afar. It is the smallest ever designed for such prac-

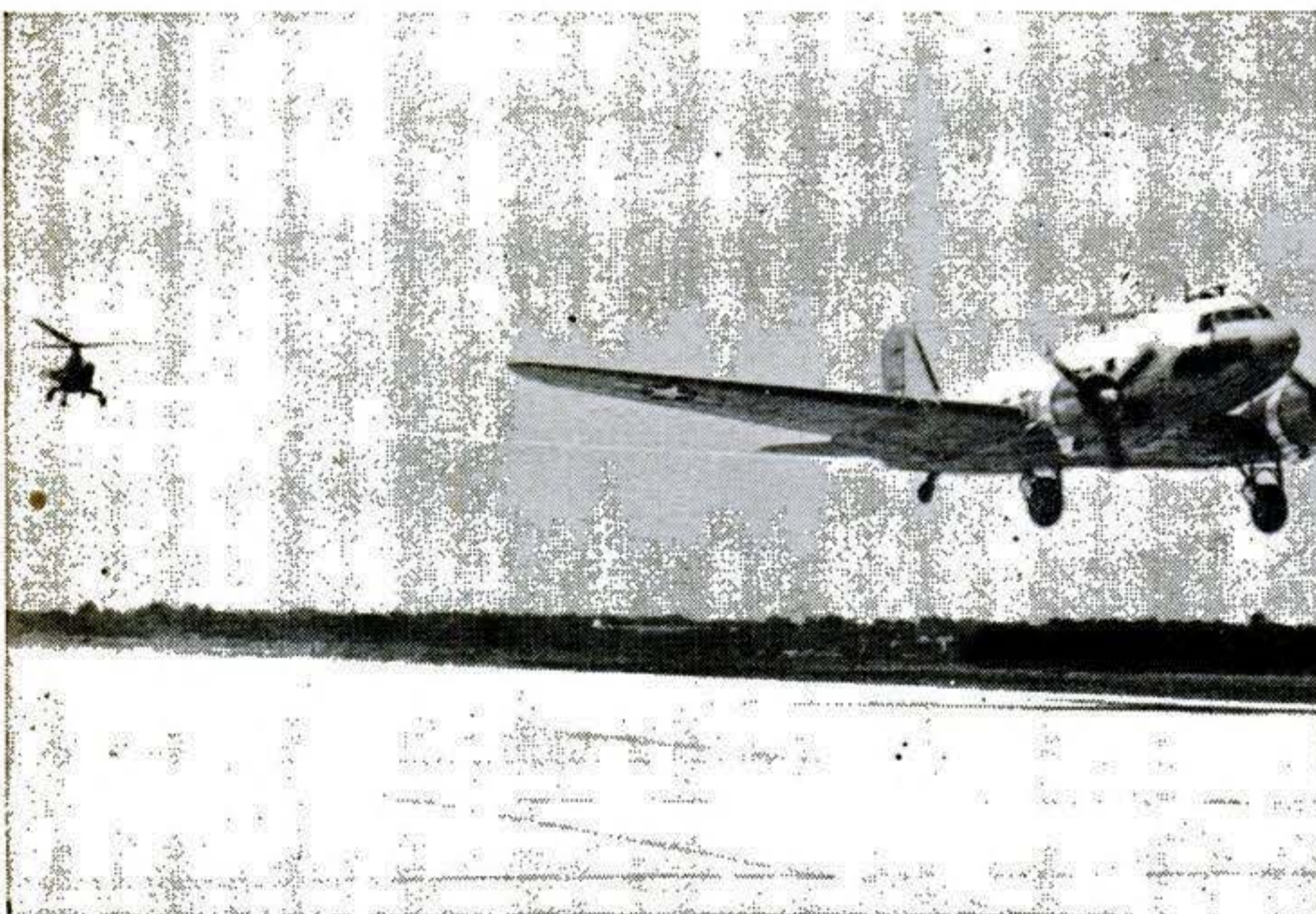

Helicopter Hitches Ride to a 'Rescue'

AERIAL hitch-hiking can greatly increase the range of rescue helicopters, experiments at Wright-Patterson Air Force Base reveal. Sikorsky S-51s and H-5s have been successfully towed by C-47s, C-54s and C-82s. The helicopter hovers in the air, with slack towrope, as the plane takes off. Once stabilized in flight, the 'copter pilot cuts his engine, but retains use of his controls at all times.

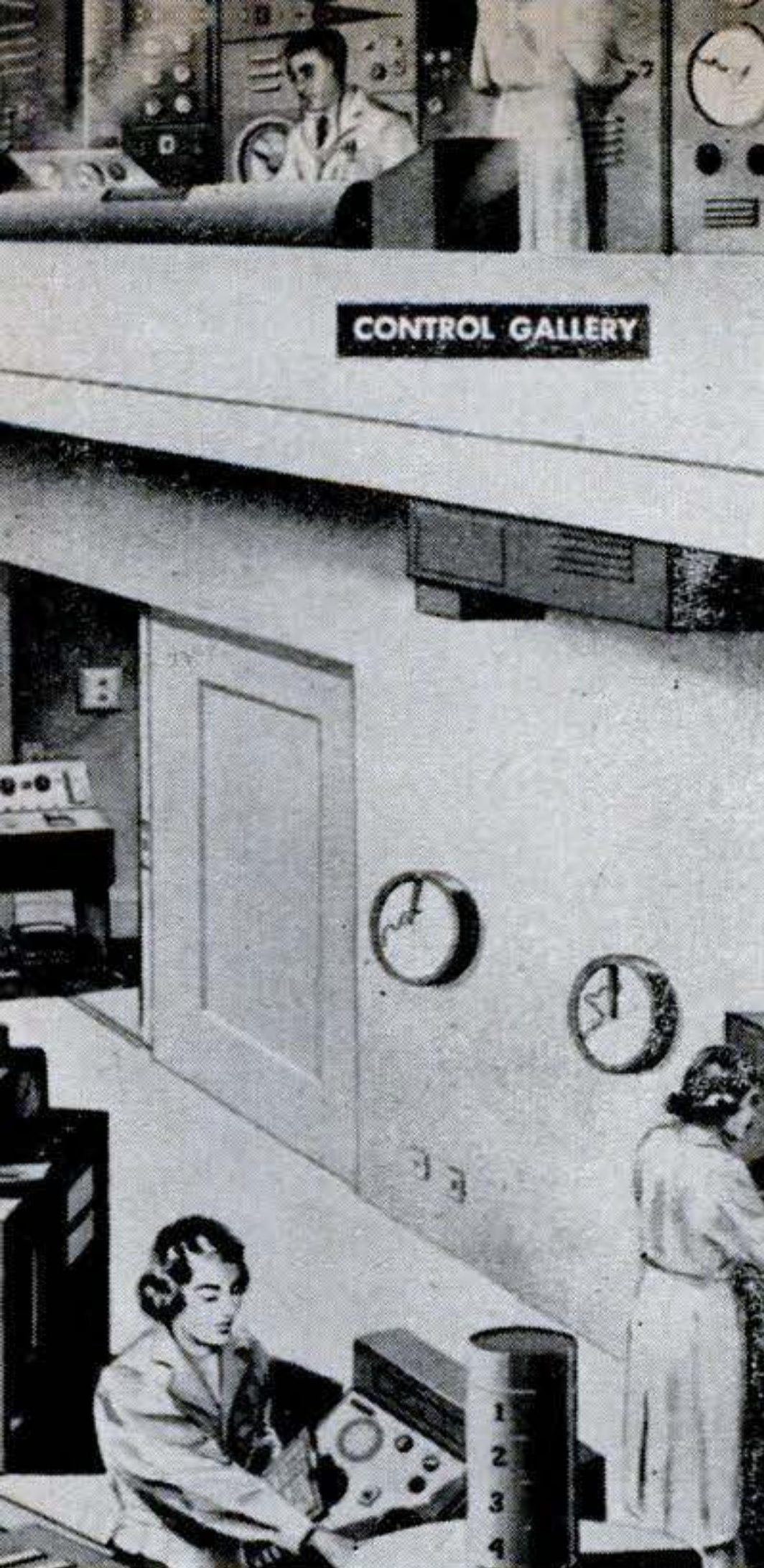

CONTROL GALLERY

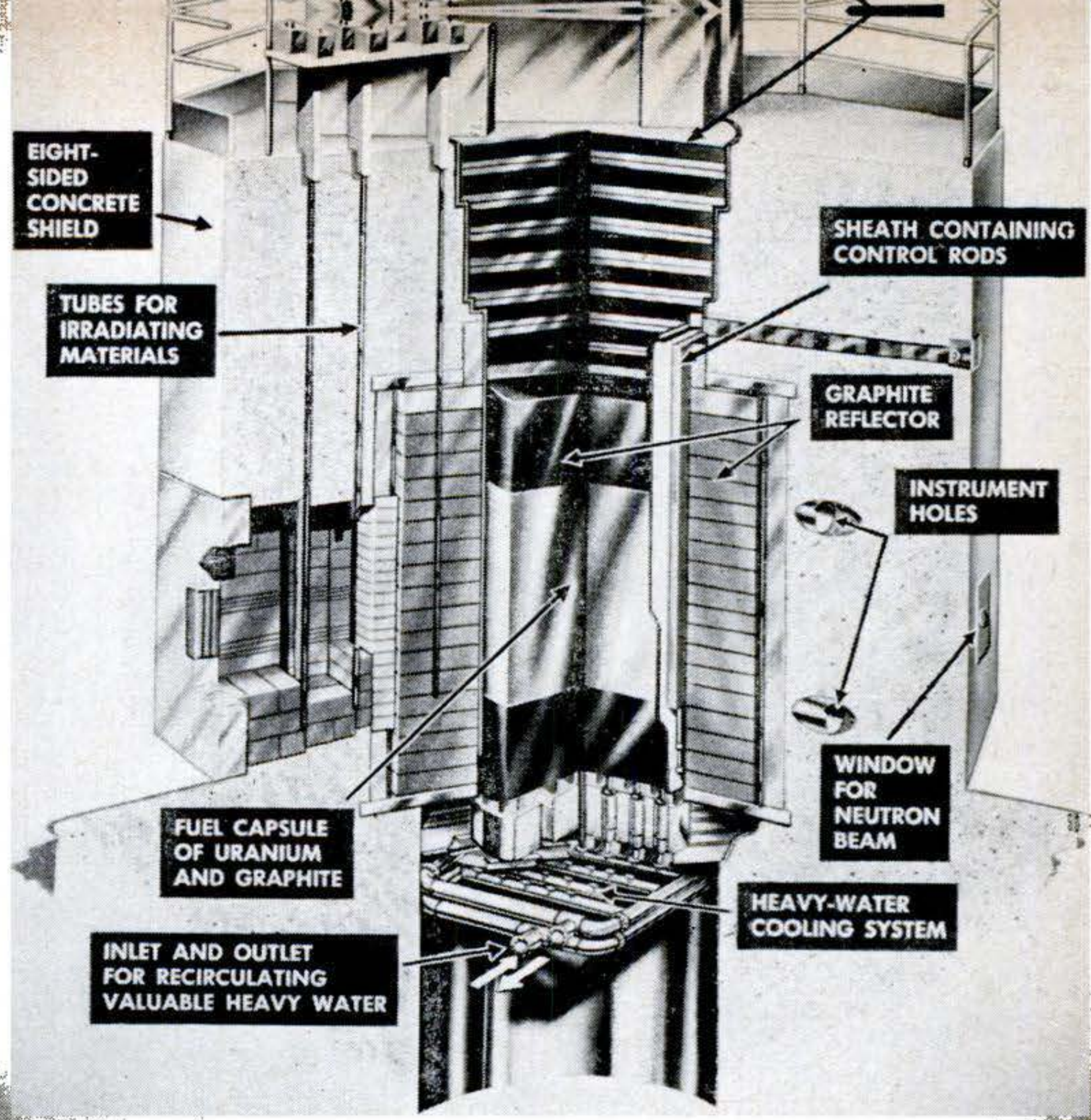

EIGHT-SIDED CONCRETE SHIELD

TUBES FOR IRRADIATING MATERIALS

SHEATH CONTAINING CONTROL RODS

GRAPHITE REFLECTOR

INSTRUMENT HOLES

WINDOW FOR NEUTRON BEAM

FUEL CAPSULE OF URANIUM AND GRAPHITE

HEAVY-WATER COOLING SYSTEM

INLET AND OUTLET FOR RECIRCULATING VALUABLE HEAVY WATER

would run it from control gallery overlooking main floor. Cutaway shows details of design.

tical uses—a concrete octagon only 19 feet in diameter and 11 feet high. The design is not secret.

A fuel capsule of enriched uranium and graphite, sealed in an aluminum can, will run the pile 10 years and can then be replaced. This obviates elaborate machinery to feed in uranium “slugs.” A novel cooling system uses “heavy” water, which ab-

sorbs fewer neutrons than ordinary water does. Automatic built-in safety features make the pile the first of its power suitable for use in the heart of a city.

Worked out for the Atomic Energy Commission by North American Aviation, Inc., the design will be made available to college and industrial laboratories. Building one is expected to cost \$1,000,000.

Inflatable Top Covers German Cycle-Car

WHEN it rains, you put up the top of this tiny German convertible by unfolding a small piece of plastic, blowing it up and buttoning it on. Deflated and folded, the top is small enough to tuck neatly into a handbag.

The vehicle is a three-wheeled car that appears to be a cross between a motorcycle and an automobile. It has a 100-cubic-centimeter, 4.5-horsepower engine.



Spray Truck Bathes New York Tunnel

WHEN New York City's Brooklyn-Battery Tunnel needs a cleaning, which is twice a month, the special tank truck shown in the photograph at the right goes to work. It sprays the white tile walls and ceilings, coated with the exhaust fumes of thousands of automobiles, until they sparkle again. The job of sprucing up the world's second-longest vehicular tunnel takes two nights to finish. It uses up 60,000 gallons of water and 7,000 gallons of cleaning solution, enough to fill several standard railroad tank cars, to wash the area of 780,000 square feet. This tunnel, New York's newest, runs under the East River from the tip of Manhattan Island to Brooklyn.

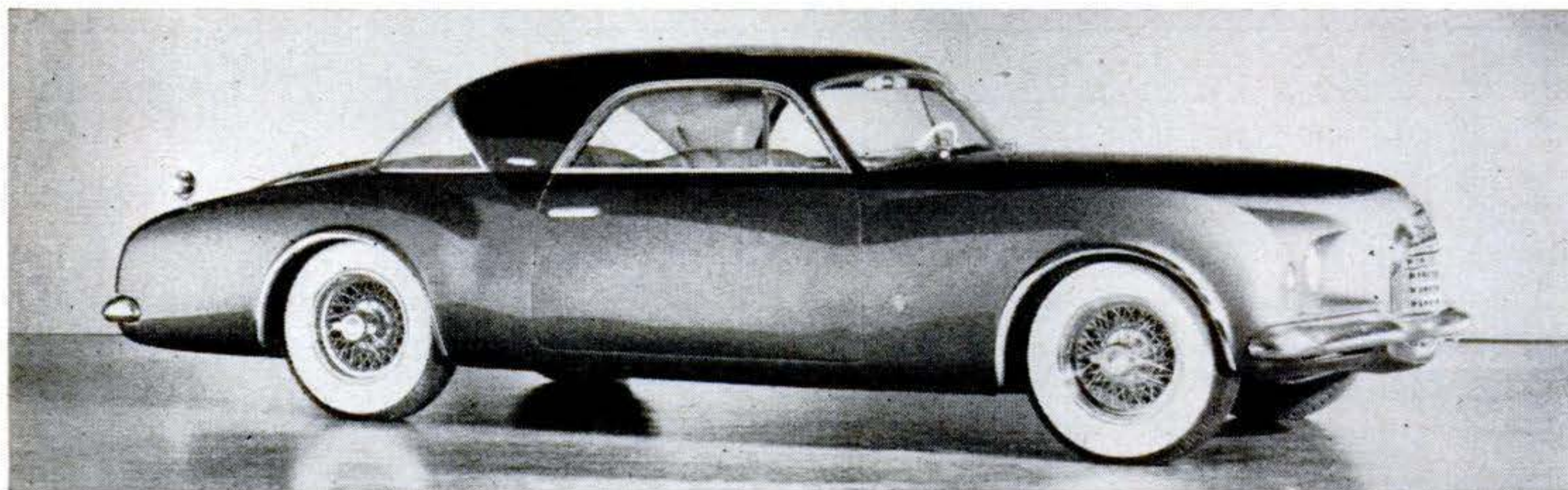
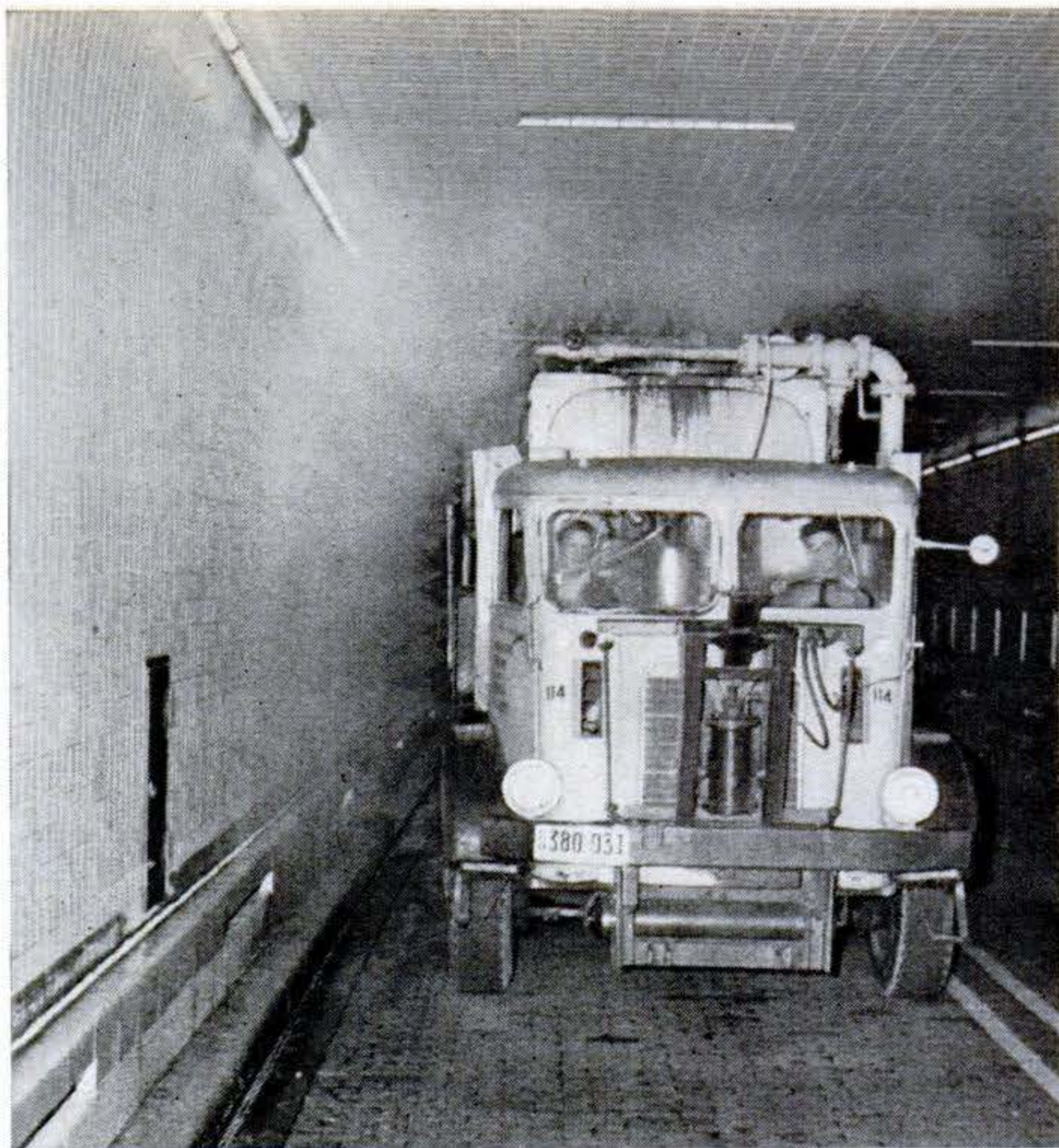

310-Hp. "Dream" Chrysler Has U.S.-Designed, Italian-Built Body

A "DREAM CAR" of 310 horsepower, with four carburetors and an 8:1 compression ratio, was announced last month by the Chrysler Corp. It was the third in a series of experimental automobiles made public in Detroit as laboratories-on-wheels.

Chrysler's car was styled in the U.S. by the company's engineers but was built in Turin, Italy, by Carrozzeria Ghia, a prominent Italian body maker.

K. T. Keller, the Chrysler chairman, said the K-310—as the car is called—"sets entirely new objectives to reach for" in passenger-car development.

The K-310 is powered substantially with the same overhead-valve engine announced by Chrysler in March, 1951 (PS, p. 134). Modifications raised its horsepower from

180 to 310. The piston displacement is exactly the same—331 cubic inches. The sole item of information Chrysler has disclosed on what it did to the engine to get this theatrical increase in horsepower is the statement that the valve sizes have been increased—plus, of course, the boost in the compression ratio. The engine burns commercial premium (Ethyl) fuel.

The K-310 has sweeping lines, a low, flat hood and large wire wheels. It has a 125½-inch wheelbase and an over-all length of 220½ inches. Added features include an adjustable steering wheel, an automatic transmission, electric window lifts, power steering and an electric seat-adjusting mechanism. One of the elevated directional and tail lights is seen sticking up on rear fender.



PINWHEEL PILOT would wear flying suit and crash helmet with plastic face shield. Flying into enemy territory he could easily carry a rifle. Cargo hook (not shown) could carry a machine gun, small mortar, ammo for cut-off units, or medical supplies. Walkie-talkie can be detached for use on ground.

Men Will 'Wear' This Helicopter

By Herbert O. Johansen

WHAT were you in the war, Daddy?" some future son may ask an ex-Marine.

"I was a helicopter," he may reply.

Junior, of course, would know all about Pinwheel, the rocket-powered helicopter rig that's worn like a back pack.

Although such a machine is still in the experimental stage, it has actually been ground-tested for the Office of Naval Research—presumably for use by the Marines.

The inventor of the gadget that converts one man into a bird is a 38-year-old aeronautical engineer, Gilbert Magill, president of Rotor-Craft Corp., Glendale, Calif. In discussing his brain child, he revealed:

- It weighs considerably less than 100 pounds, yet can easily carry a man plus 100



THE HOPPICOPTER, earlier back-pack rig, weighed only about 60 pounds, but its two-cylinder, 20-horsepower engine wasn't able to lift a man more than a few feet.

or so pounds of his equipment in flight.

- It will take off vertically faster than any helicopter and descend vertically for a gentle landing in an area the size of a desk top. It will hover in mid-air and, in case of engine failure, can windmill down for a leisurely emergency landing.

- It is strapped to the pilot's back. He sits on a bicycle-type seat, with perhaps a footrest from which a cargo hook dangles. Mounted on a tubular control stick in front of him are the throttle, a simple instrument panel with perhaps a tachometer and altimeter, and a walkie-talkie.

- When he is ready to take off, a turn of the throttle releases liquid chemicals from twin fuel tanks mounted on his back. When these chemicals meet in the combustion

ONE OF SMALLEST HELICOPTERS to fly is Little Henry, a test rig. It weighs 310 pounds, can lift about 300 pounds of load. Unlike the Pinwheel, it uses ramjets to spin its rotor.



chambers of tiny rocket engines at the tip of each rotor blade, they mix and ignite instantaneously, creating a rocket-jet thrust that spins the rotor at high speed.

- It will be ideal for night operations into enemy territory. Its rocket engines spew no flame and are much quieter than ordinary jets, although they still sound somewhat like a muffled locomotive.

Flapping Wings Have Failed

The Pinwheel comes close to satisfying one of man's oldest ambitions—to fly by himself like a bird. The ancient Greeks wove a story around that theme, and Leonardo da Vinci left us a design for a pair of flapping wings powered by human muscles. The flapping wings never worked, however, and man finally resigned himself to sitting inside a machine that would do the flying for him.

Yet he still yearned to make like a bird in "personal" flight. Then the helicopter came along with what seemed to offer a bright light of success. Back in the Thirties, Dr. George de Bothezat designed a one-man, back-pack helicopter, but his death brought the project to a premature end.

Then came Horace T. Pentecost's Hoppicopter in 1945 (PS, July '45, p. 68). Powered by a 20-horsepower, two-cylinder engine, it was strapped to the pilot's back. When a 180-pound Air Force officer tested it, however, he wasn't able to get more than six feet off the ground. Another version, with landing gear (PS, May '48, p. 117), didn't do much better.

Civilian Use Foreseen

Magill is convinced that he has the answer in rocket power. At present he is concentrating on purely military applications, especially for situations where long range and high speed are not a factor. (A guess would be a speed of about 60 miles an hour and a range of about 20 miles.)

He does, however, look ahead to its possible civilian use as a sort of aerial scooter. Greater range and lower cost would first have to be built into rocket fuels. Then, as a civilian probably would not want to don a crash helmet and flying suit to hop across town, the seat could be enclosed in a plastic bubble—perhaps big enough for two. Small casters might be added for landing.

But there we are—getting right back from personal flight to man surrounding himself with a flying machine. END



COINS FROM A NICKEL UP feed the appetites of America's slot machines—illegal in 43 states and robbers in all.

**For sheer greed, a mechanical gambler beats them all—
even when it's "honest." And most of them are fixed.**

By Hartley E. Howe

ANYBODY who gambles steadily with a professional—and a slot machine is very much a professional—is bound to come out a loser in the long run. That's because the pro makes his living by taking something from each bet or play. How much and how quickly a sucker loses depends on this "take." The take of a slot machine would make Canfield himself blush.

An "honest" machine—one operated with real self-restraint—keeps 25 cents out of every dollar put in. An average machine keeps about 33 cents out of a dollar. But a machine that has been fixed—and it's not hard—keeps anything up to 80 cents out of

every dollar played. The only reason it doesn't keep still more is that a machine has to pay off occasionally to keep the customers coming back.

As you probably know, the machines pay off varying amounts when certain symbols line up on three drums that are spun by pulling a lever. The odds that are built into a machine depend on the number of times the pay-off symbols—bells, cherries, bars and so forth—appear on the drums. But the pay-off is always far less than the actual odds against the player. In a 25-percent "take" machine, for example, a combination that pays back 16 to one only shows up once in 500 times, while the common two-to-one pay-off actually has odds of more than

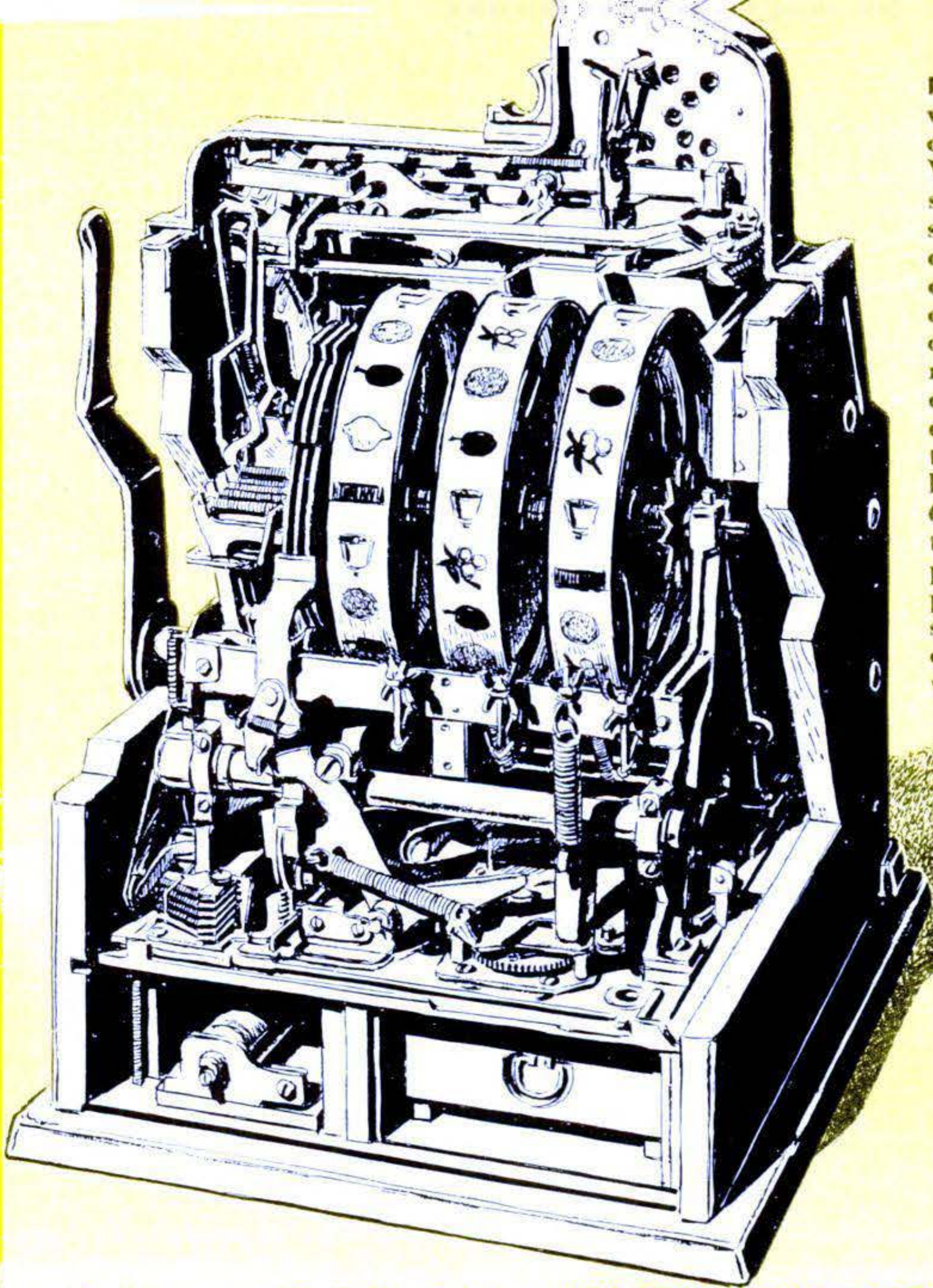

REAR VIEW of slot machine with back removed shows complexity of mechanism. Window where player sees symbols come up is on far side. Actually only every other symbol of 20 on each drum can come up: others are dummies to encourage players with "near misses." Jack pot, which comes up on average of only once in a thousand tries, pays off 20 coins plus bonus (maximum, about 67 coins) from special container. There are two jack-pot containers, so that two pay-offs could be made on successive plays. Machine can be adjusted for play with slugs or coins.

SPIN AND BRAKE MECHANISM is shown separately in simplified drawing at right. Angle of view is same as for complete machine (above). Operating lever (far left) is shown half pulled, twisting pivot bar. This has stretched both latch and drive springs. Both are released when lever is pulled down rest of way. Drive spring then twists bar back and connecting lever system makes drive pawl kick three notched disks. Each of these is fastened to one of three drums on concentric axles, so drums now spin. Meanwhile latch spring runs clockwork that pulls over latch bar. As this moves, foot of each stop lever slips in succession off its edge, allowing small spring to pull stop pawl at other end forward into a star wheel, stopping a drum. As each star has only 10 points, only every other symbol can come up at window. Machine can be "fixed" by weighting drums so few pay-off stops are made. Also, points of star wheels can be greased or filed away.

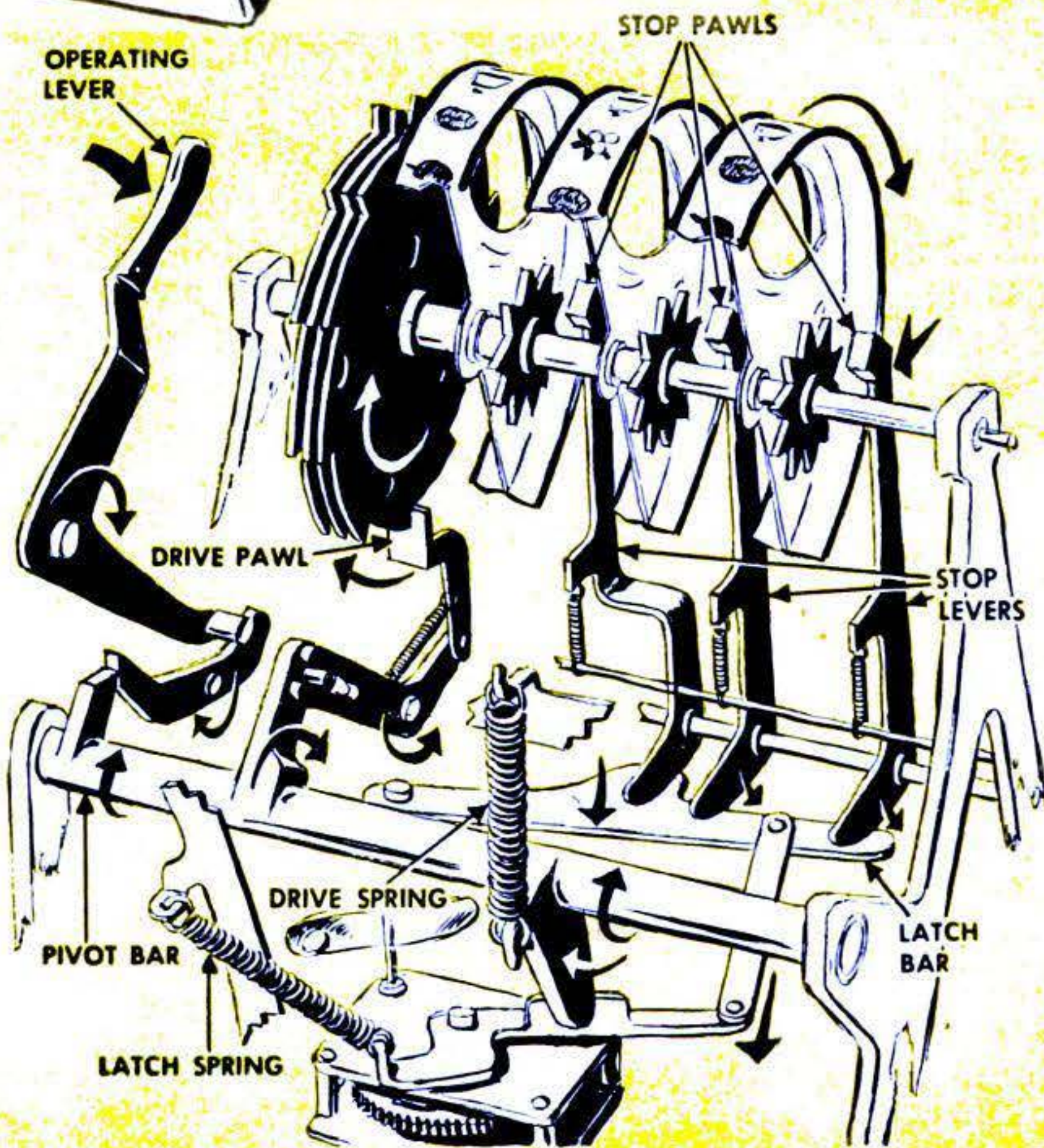

eight to one against its ever coming up.

The ingenious mechanism that sees to all this hasn't changed very much since the Gay Nineties when a fellow named Charles Fey invented the first slot machine out on San Francisco's Barbary Coast. The customer works it by inserting a coin and pulling a lever. This does five separate things:

- It powers a spring that spins the drums.
- It powers a gear train that sets brakes to make the drums stop in the same order every time.
- It sets a mechanism that sorts the money among a pay-off tube, the jack pot and the house cash tray.
- It makes the pay-off, if any, of just the

PAY-OFF MECHANISM, simplified, is shown below. Each of three notched disks is on same axle with one drum. When a drum stops so that a pay-off symbol shows in window, connected disk stops so that a hole in it is opposite one of fingers at left. When two or more pay-off symbols line up in proper sequence, holes in disks line up so that one finger can be spring-pulled to right. This moves foot of release lever to left, kicking over one or more of horizontal stop bars. Movement of bars allows same number of slotted pay-off plates to be pulled back by springs. Each of bottom two plates carries two coins; other four plates carry four coins each. Coins are brought from column in coin tube to pay-off hole and drop through. Jack pot releases all 20 coins in pay-off plates, opens one of special jack-pot containers.

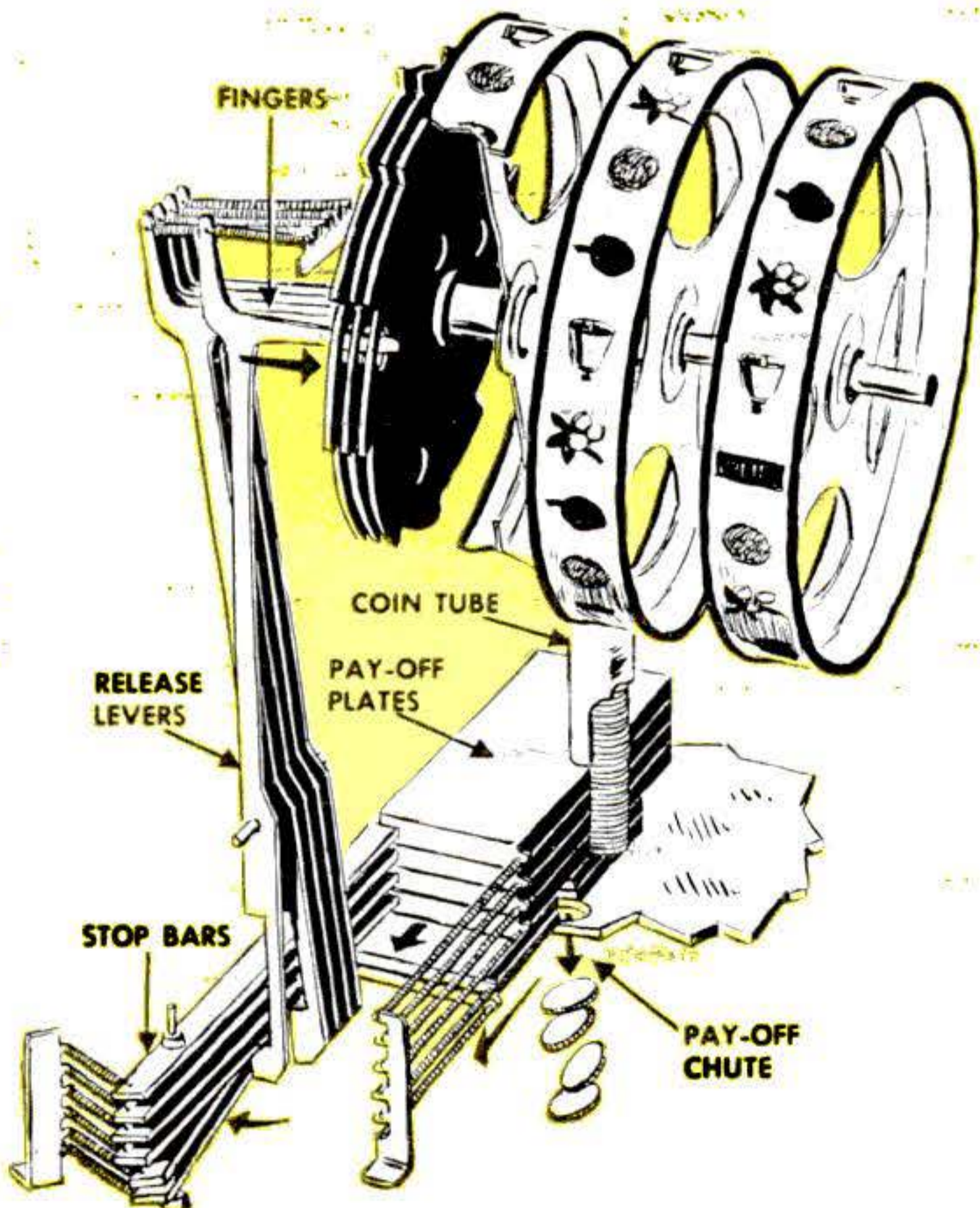

amount indicated by the window symbols. ● And at the end, it resets the entire mechanism for the next play.

Making these clever devices has grown into quite an industry since Fey's day. In 1947 for example—up-to-date figures are impossible to get—10 manufacturers of what they like to call "bell-fruit machines" shipped more than 49,000 slots, worth about \$16,000,000 retail.

But this is small change compared to the profits of the men who own and operate the

[Continued on page 238]

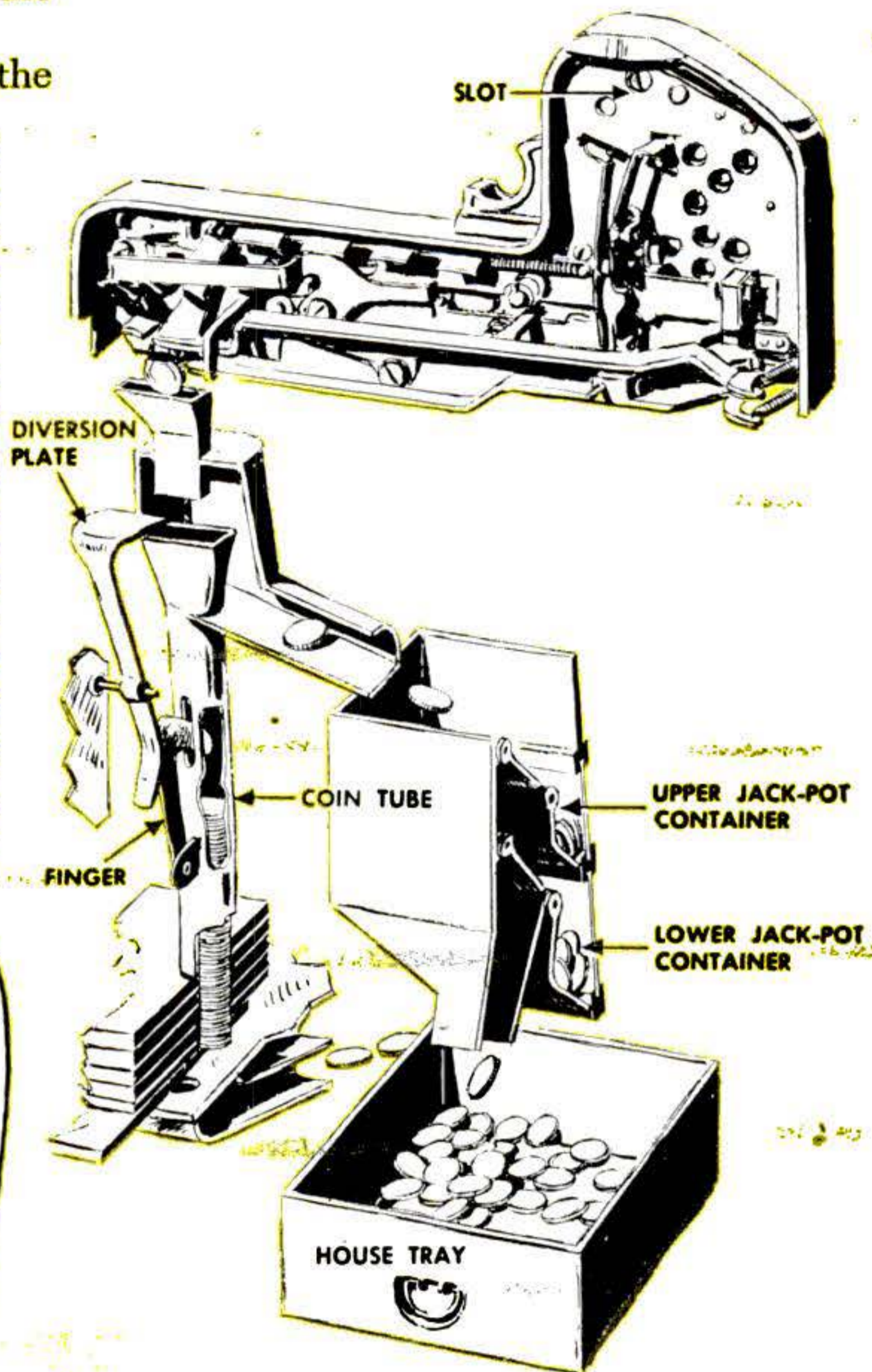

COIN-SORTING MECHANISM is shown in simplified form above. When player drops coin in slot it releases brake (not shown), allowing operating lever to be pulled. This makes fingers move coins to left along top track until one drops into coin tube. When coins have filled tube they push out finger that in turn pushes out bottom of pivoted lever. This moves diversion plate on upper end of lever forward, blocking coin tube. Hereafter coins slide down chutes to two jack-pot containers. When these are filled, their trap doors jam, coins slide into house "take."

"High-Hat" Hot Rods Combine

THIS eye-catching conversion of a '41 Ford Club Coupe, hardly four feet high, is what Bob Trammel, North Hollywood, Calif., body worker, wound up with in his

attempt to combine streamlined beauty and top performance with the ease of a family sedan. The Mercury engine kicks up 206 horsepower for high-speed cruising.

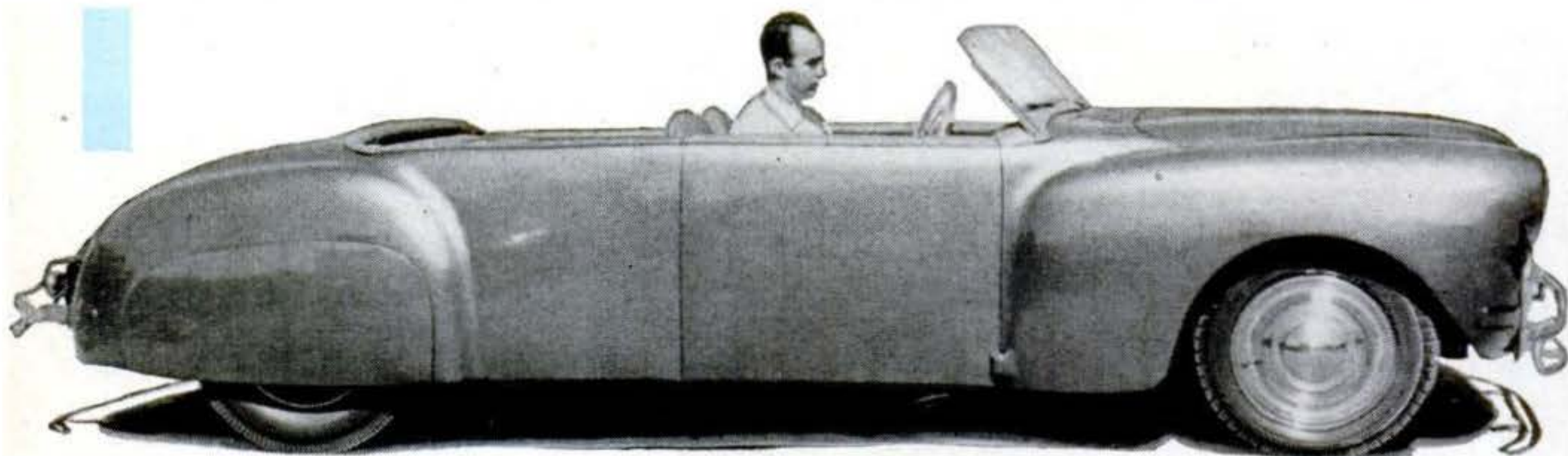

DETACHABLE BUBBLE TOP of clear plastic snaps into place quickly. It was once the upper half of a bomber's nose. Note that there's no door on left side of car.

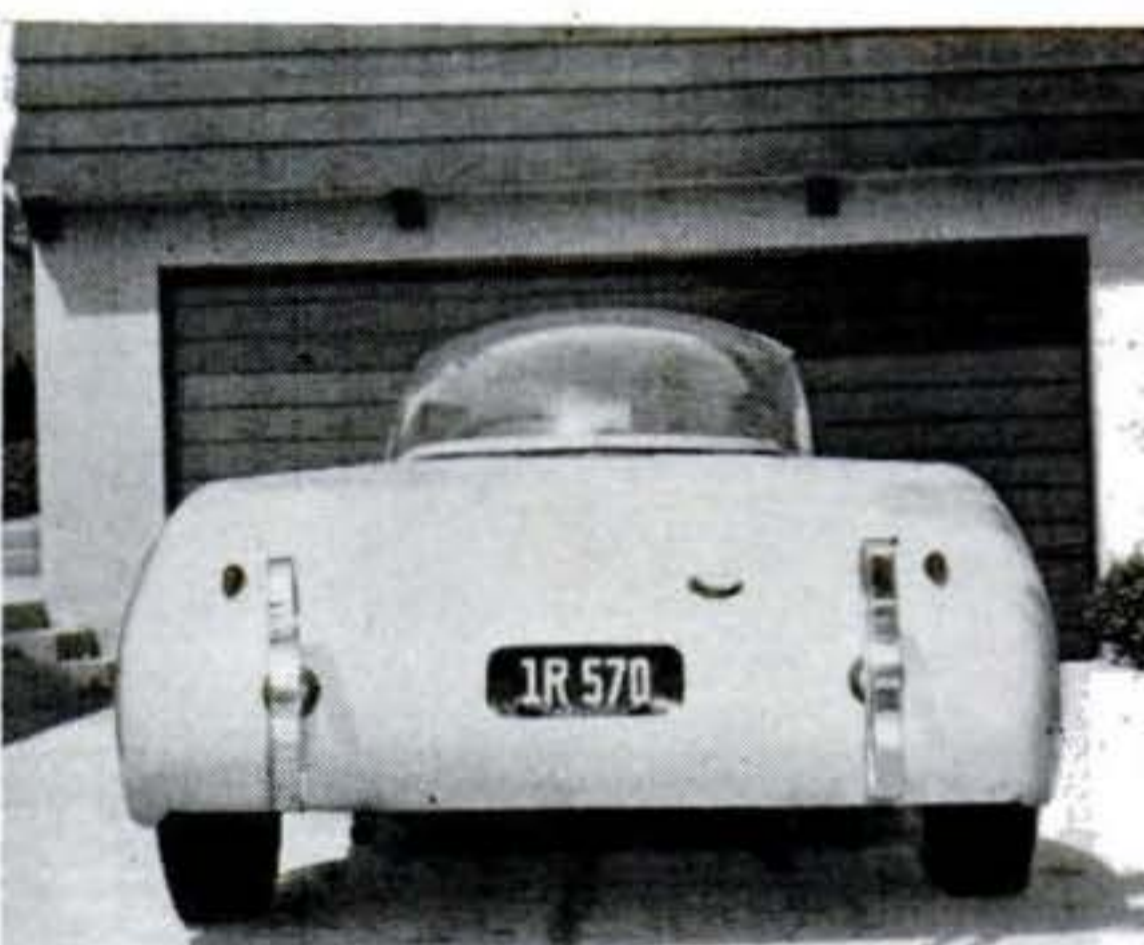

SEPARATE BUMPERS, shaped from steel, are placed vertically. Tail lights are aircraft wingtip-light covers. The roadster cost Davidson around \$1,500; he has re-fused \$3,000 for it.



BODY'S UNUSUAL TAPER to a wide end is shown in view from above. To learn welding, 23-year-old designer got a job as apprentice in a sheet-metal shop.

THE neighborhood kids call this sleek speed wagon "The Jelly Roll" because of its elongated shape and maroon paint job. Woodrow Janson of Cedar City, Utah,

wanted a luxury car and a high-velocity vehicle with a racing body—all on the same set of wheels. His dream came true in this 1,564-lb. custom job. She'll top 130 m.p.h.



Speed and Comfort

These homemade honeys are whistle-bait for custom-car fans wherever they go—but that's only half their charm.

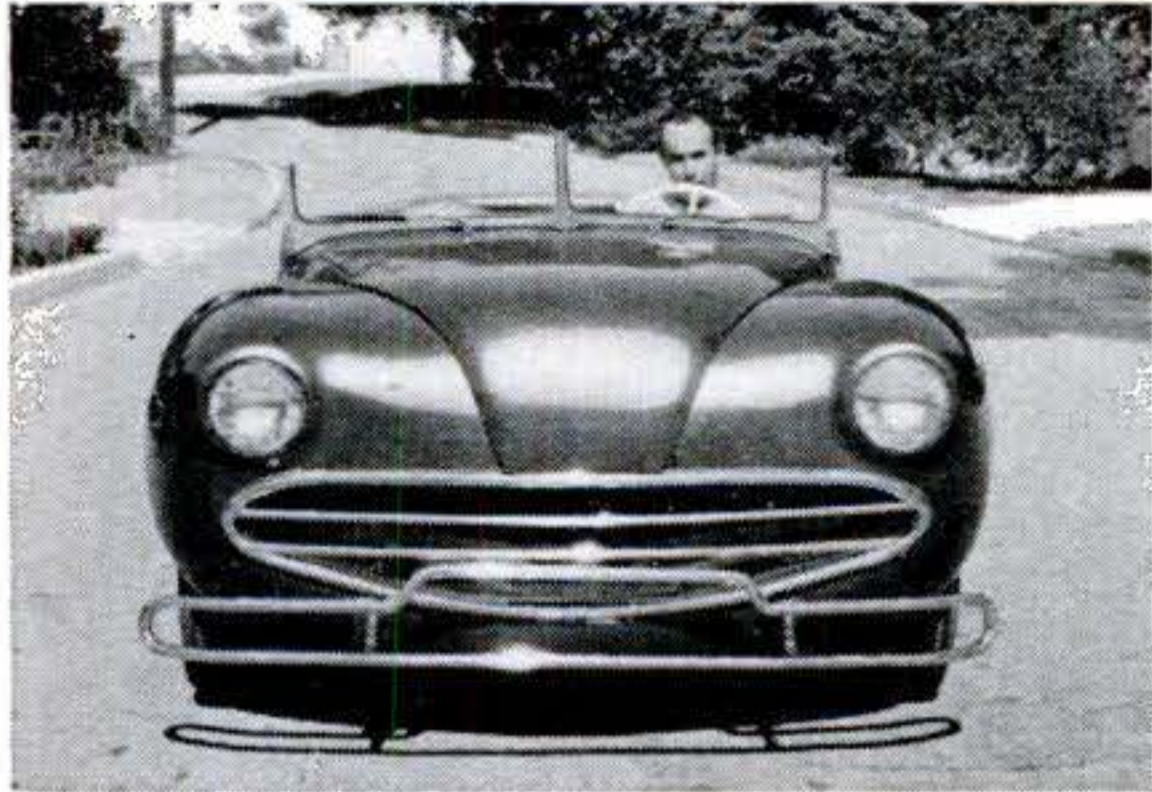

TUBULAR BUMPERS SET LOW and hand-formed grille emphasize the car's ground-hugging lines. Wheelbase and tread are only dimensions left unchanged.

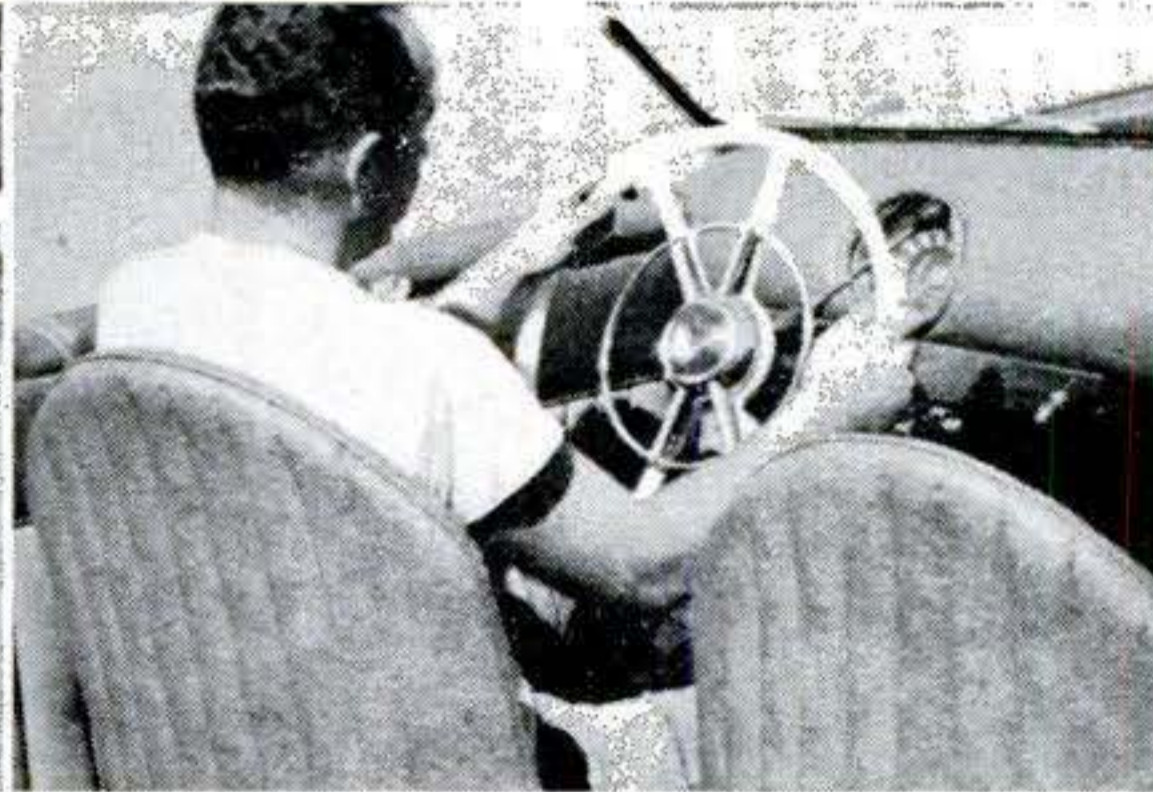

CAR IS UPHOLSTERED IN LEATHER over foam rubber. Its brown and tan interior looks well with the metallic-blue body. A speedometer is the only instrument on the padded front panel.

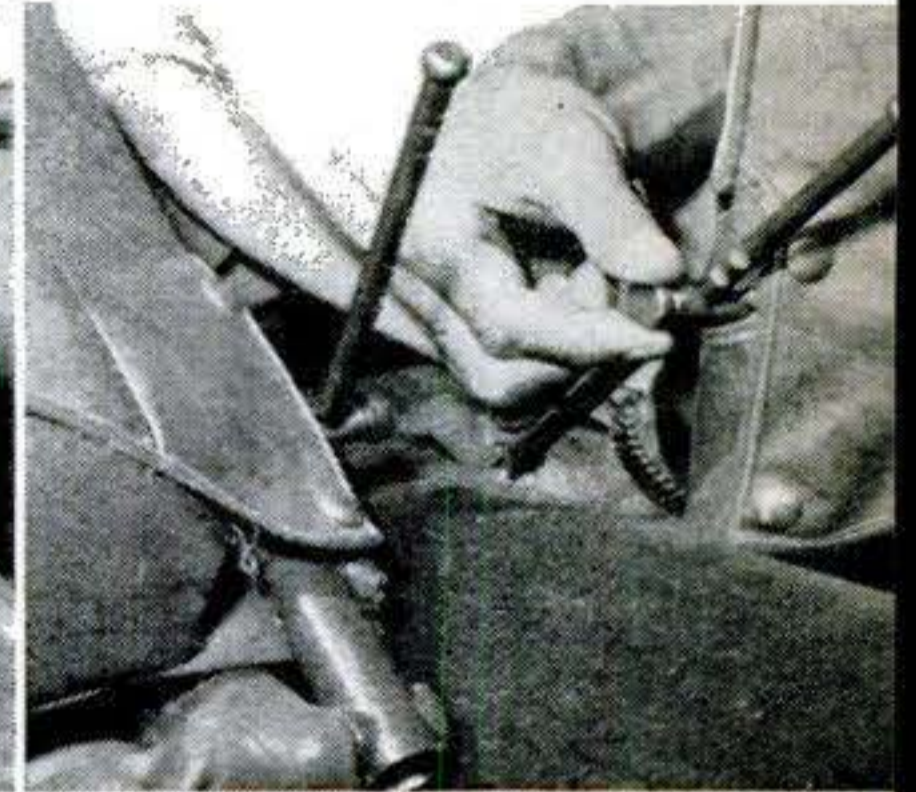

ROD MOVES BUCKET SEATS fore and aft, tilts them to suit. Lowering floor nine inches below frame raised drive shaft into body—it makes a handy arm rest.

THREE and a half years of Californian Stanley Davidson's spare time transformed a hodgepodge of auto and airplane parts into this motorized masterpiece. Main

ingredients: '48 Caddy grille, '46 Olds hood, '38 Plymouth front fenders, '40 Buick Super rear fenders. 126-inch-wheelbase chassis is '40 Mercury—engine a souped-up '41 Ford.

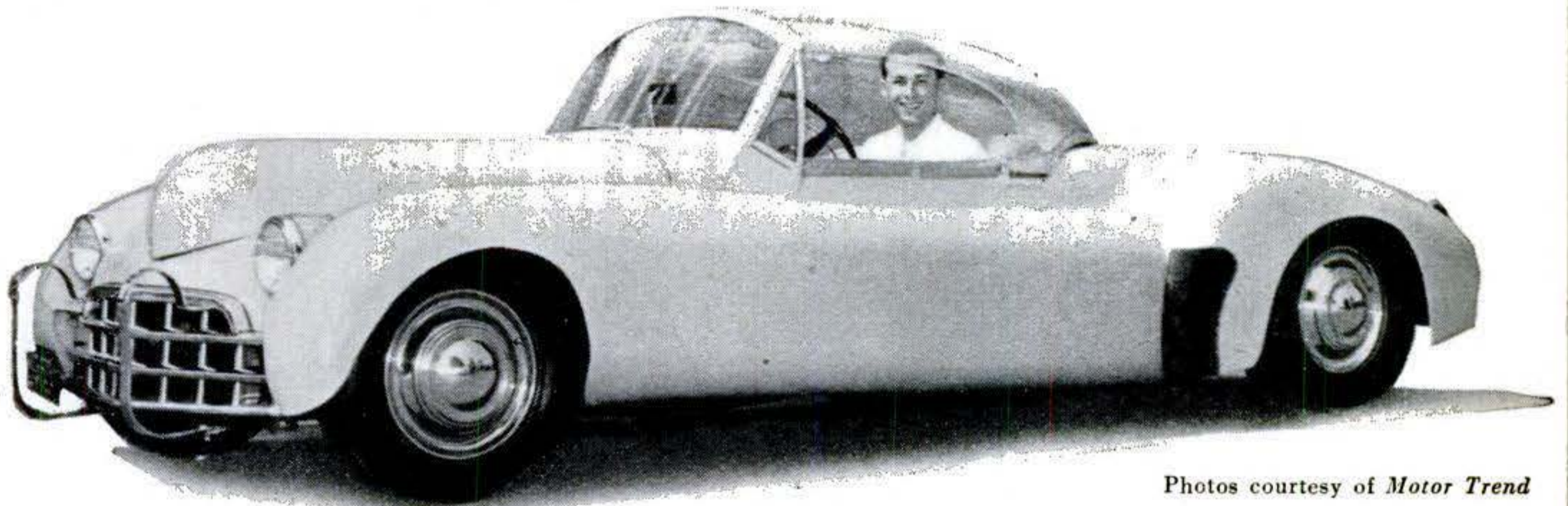

Photos courtesy of *Motor Trend*

BLUNT CONTOUR OF NOSE was formed by tack-welding and riveting parts of fenders. Front axle was narrowed to help car hold the road at high speed.

AN IMPOSING ARRAY OF GADGETS, dials and instruments adorns chromed-steel panel. Soft, thick gray carpet covers floor. Car has standard gearshift, hand-braking for rear wheels.

POWER PLANT is a 1950 Ford truck engine—beefy enough for reboring with plenty of metal left in cylinder walls. Hose feeds gas to three carburetors.

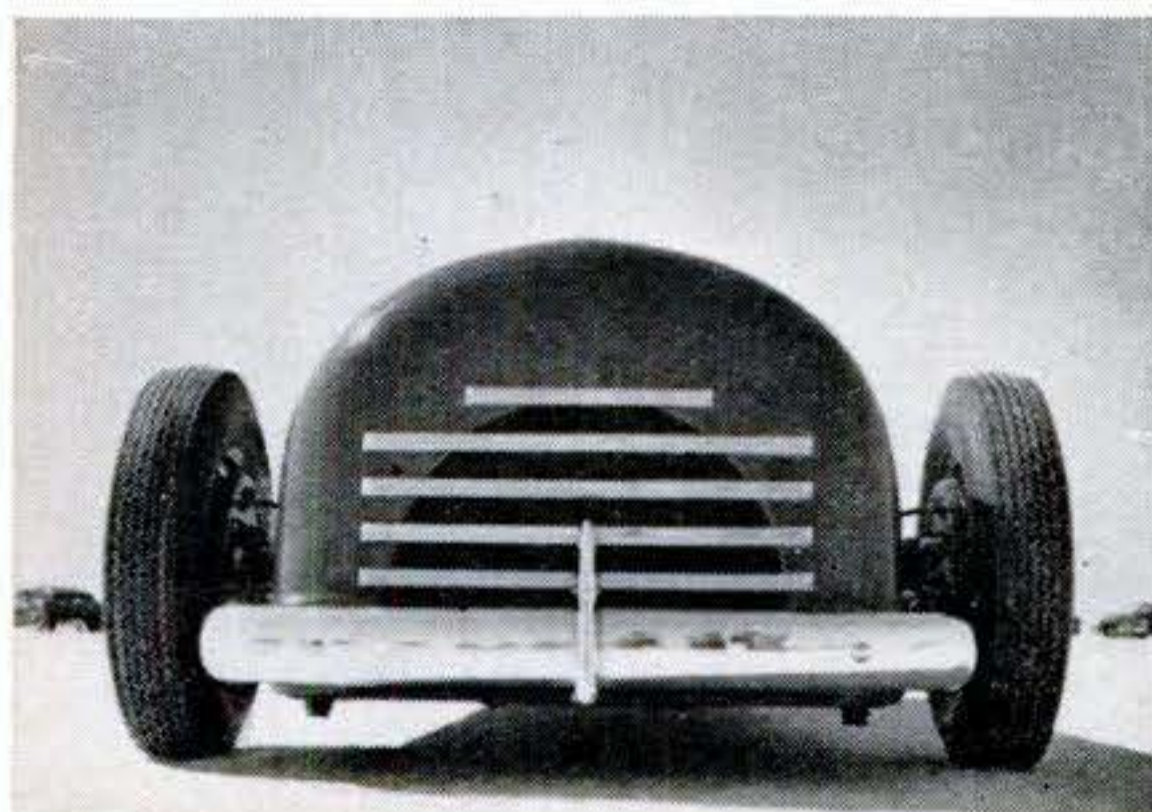

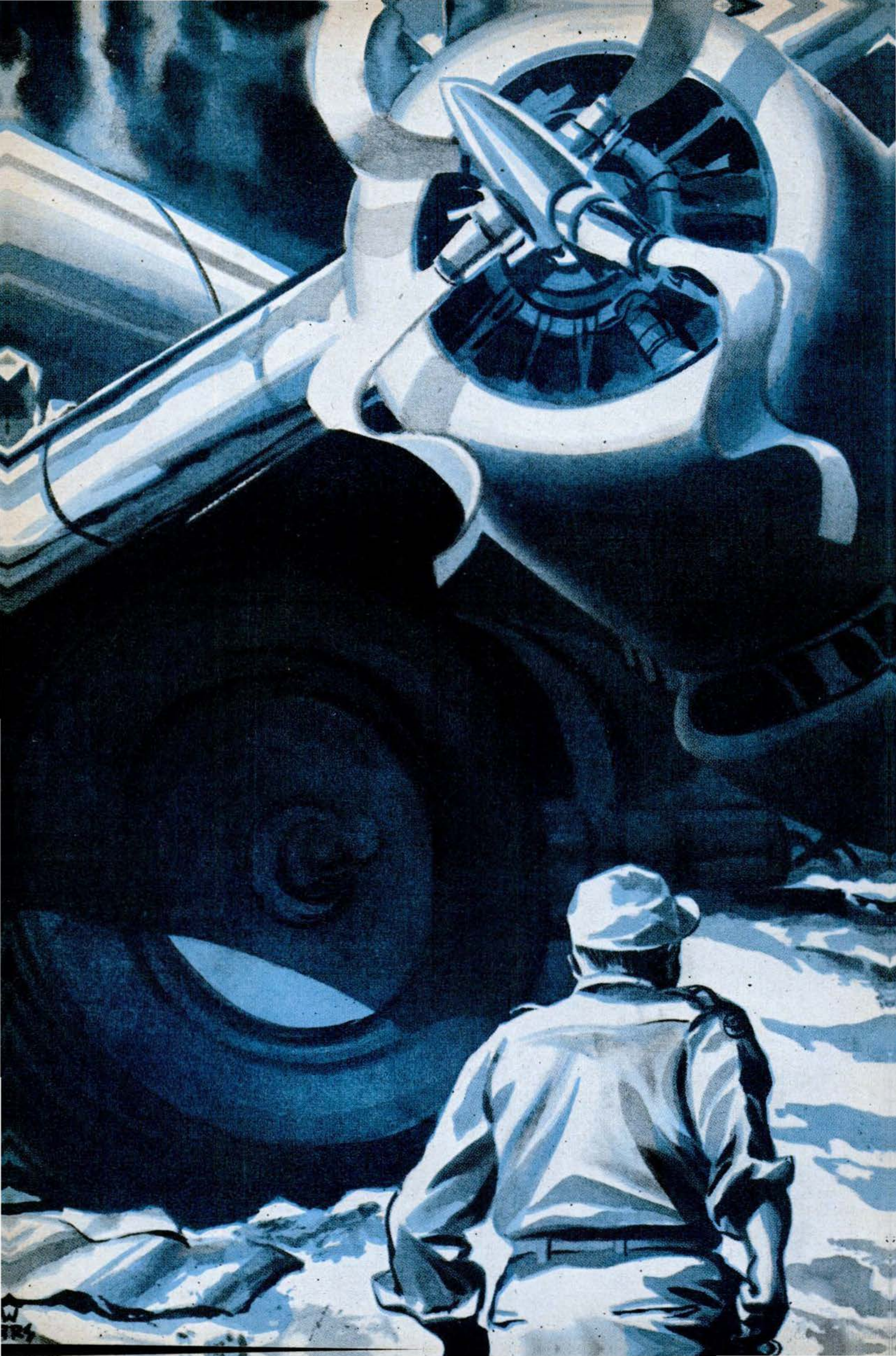

Trouble Is Their Pastime

"The most hazardous noncombat flying" is just a hobby to puddle-jumper pilots of Civil Air Patrol rescue teams.

By Joseph Stocker

SHOCKED and blood-smeared, two young Air Force officers surveyed the carnage about them—chunks of a crashed B-50 bomber still giving off clouds of black smoke, and the blackened, broken bodies of their 12 crew mates. Ruefully they calculated their chances of being found on the remote and desolate sweep of western desert that seemed like the very edge of the world.

Then their ears caught the wonderful music of an airplane engine. They scanned the sky. Plodding stoically up from the south, low over the ground, came a humble puddle jumper.

CAP to the Rescue

The civilian pilot circled, looking for a clear spot amidst the cactus and mesquite. He landed and, a few minutes later, flagged in a passing Navy trainer. Then each plane took off with a survivor.

The puddle-jumper pilot responsible for the rescue was a member of the Civil Air Patrol. And this is the sort of thing the CAP does almost every day as America's foremost organization of aerial bird dogs.

Search-and-rescue, the CAP calls it. But CAPers themselves have a more relaxed term. Comes news of an airplane missing, a hunter vanished into the snowy wilderness, a child lost in the mountains, and the word goes out that "the big flap is on."

Bookkeepers bang shut their books and leg it for the airport. Storekeepers turn their stores over to their clerks. Lawyers

JANUARY 1952 97



Then their ears caught the wonderful music of an airplane engine.



A LARGE RELIEF MAP in the headquarters of the Tucson, Ariz., Civil Air Patrol squadron helps officers set up coordinated flight plans for search-and-rescue missions.



THE BIG FLAP IS ON. From the cockpit of his little single-engine craft, an eagle-eyed CAP pilot scans the rugged Arizona terrain below him for signs of a crashed plane.

gallop out of their offices past waiting clients, and doctors reschedule their patients.

These and a hundred thousand others—bartenders, stenographers, salesmen, ex-GI pilots who flew with Doolittle, and strictly Sunday flyers who never touched the stick of anything hotter than a Cub—these are the aerial bird dogs of CAP.

They are proving themselves as useful in peacetime as in the early days of World War II, when the newly organized CAP hunted Nazi sub packs besieging our coasts.

Find Lost Skiers

One winter week end, two skiers from Los Angeles wandered off into California's wild San Bernardino Mountains and became lost. Panic, exposure and hunger had them pretty well whipped next morning when suddenly a CAP search plane buzzed in out of the gray murk and wagged its wings cheerfully. The plane radioed their location back to its base and a few hours later a ground party picked them up.

In New Mexico a big Air Force plane splattered itself across a 13,000-foot mountain in midwinter. One crew member was killed but nine survived. For two days they crouched on the crest of the mountain, tortured by the blast of a cold wind that stung like a million icy needles.

On the third day, a two-place Taylorcraft pattered leisurely in from the northwest and circled less than 200 feet over their heads. It was a search plane from CAP's unit at Alamosa, Colo.

Then began an exhibition of flivver flying

that survivors of the bomber crash talk about to this day.

The pilot circled low, dropping food, blankets and cigarettes. On one pass he cut his engine to yell, "Hang on! Help is on the way!" Then he flew back to his base, reported the crash location, took on another load of supplies and returned to the mountain.

Six Trips in One Day

This time he spied a saddle of ground not far away from the waiting fliers. The pelting wind had swept it clear of snow. "I'm going in," he announced impassively, and proceeded to do just that. The altitude was 12,800 feet. The CAP men came back six more times that day and landed to deposit supplies. Next day a ground party reached the shivering survivors.

Lost planes and lost people account for a goodly number of Civil Air Patrol's "big flaps," but by no means all of them.

Oklahoma City CAPers, for instance, went big-game hunting—to find a footloose leopard that hopped the wall to try life outside the zoo and scared the pants off the townspeople.

On occasion, however, the CAP can be a dumb animal's best friend. There was the Mississippi farmer's Jersey cow, heavy with calf, that crashed through a fence, swam a river and disappeared into a swamp. The farmer hunted for two days and finally called the CAP. In 20 minutes a plane had spotted bossy and, beside her, teetering on

[Continued on page 242]

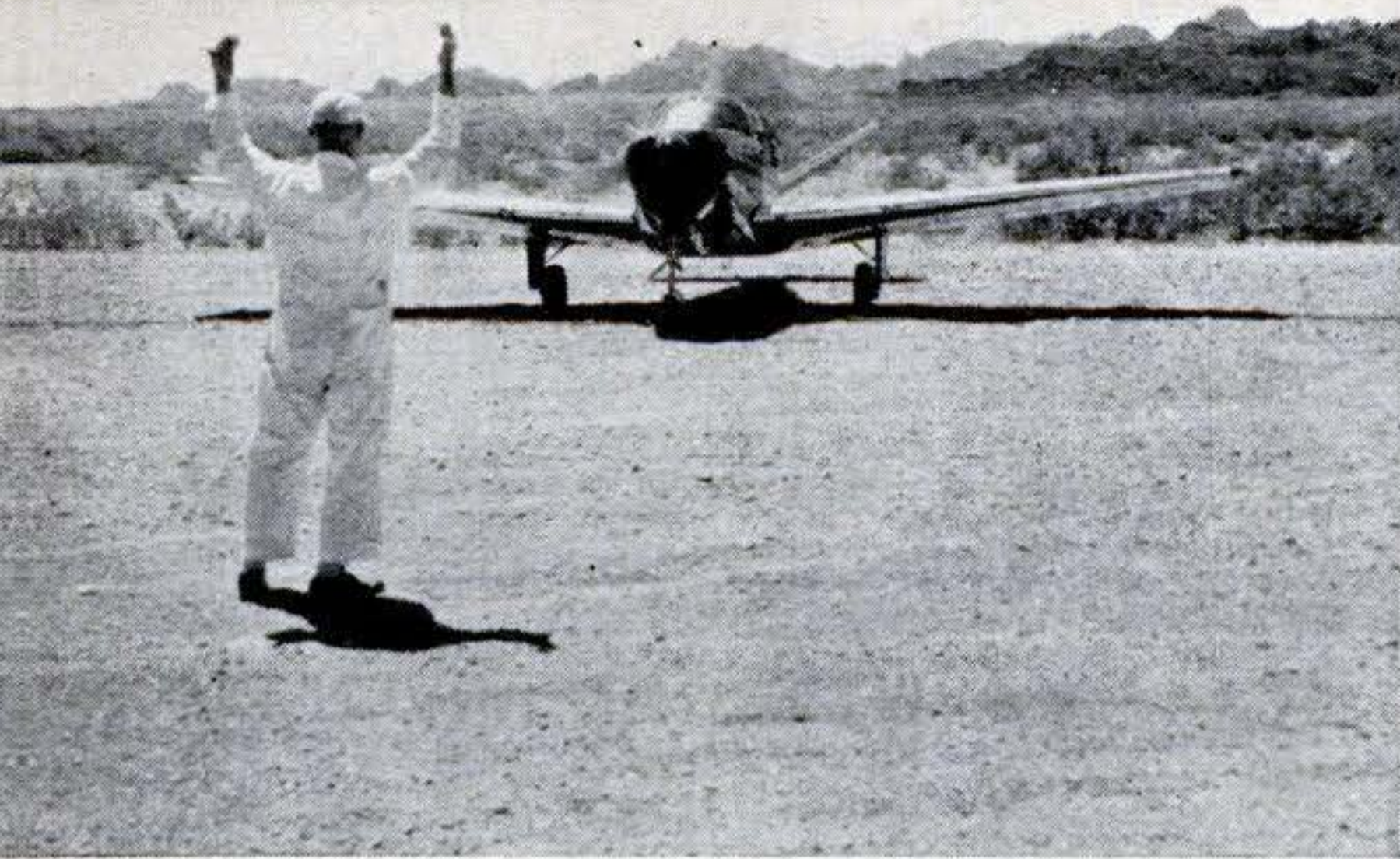

GROUND CREWMAN signals a CAP pilot to taxi into position as he returns to base for refueling. On search-and-rescue missions, the Government foots the bill for gas and oil.

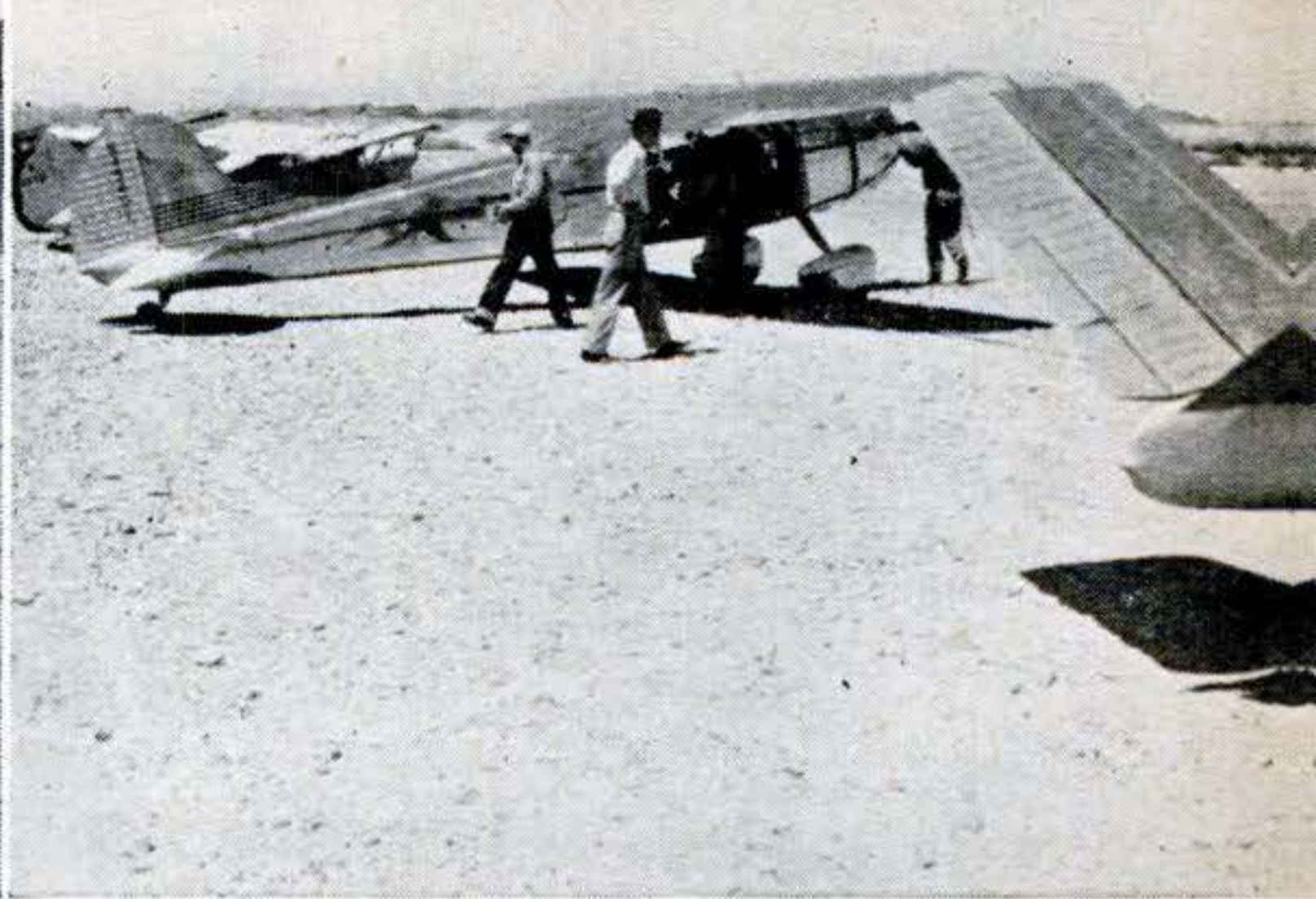

DESERT STRIP at Lake Havasu, Ariz., is the bustling base of one of the 1,500 CAP units scattered throughout more than 1,000 communities in the United States.



Circling low over the crashed bomber, the CAP pilot dropped food, blankets and cigarettes.



Four Lanes Painted at Once

WHEN this highway striper makes one trip over a road, four lane markings are painted in place at one time. A 30-foot boom on the rear of the vehicle is adjustable to various widths so that a double center line

and two single lines are laid down. A periscope-like device enables the driver to hold a straight course. Skip stripes can also be laid down by this machine, which was invented by Sgt. Carl G. Sohmer of the Tacoma Police Department.

New Plane Totes More

MEET the Convair-Liner 340. Newest and largest twin-engine transport, it carries a ton more payload faster and higher than Convair 240. It is fitted with 2,400-horsepower Pratt & Whitney reciprocating engines, but turbo-prop engines can be installed.

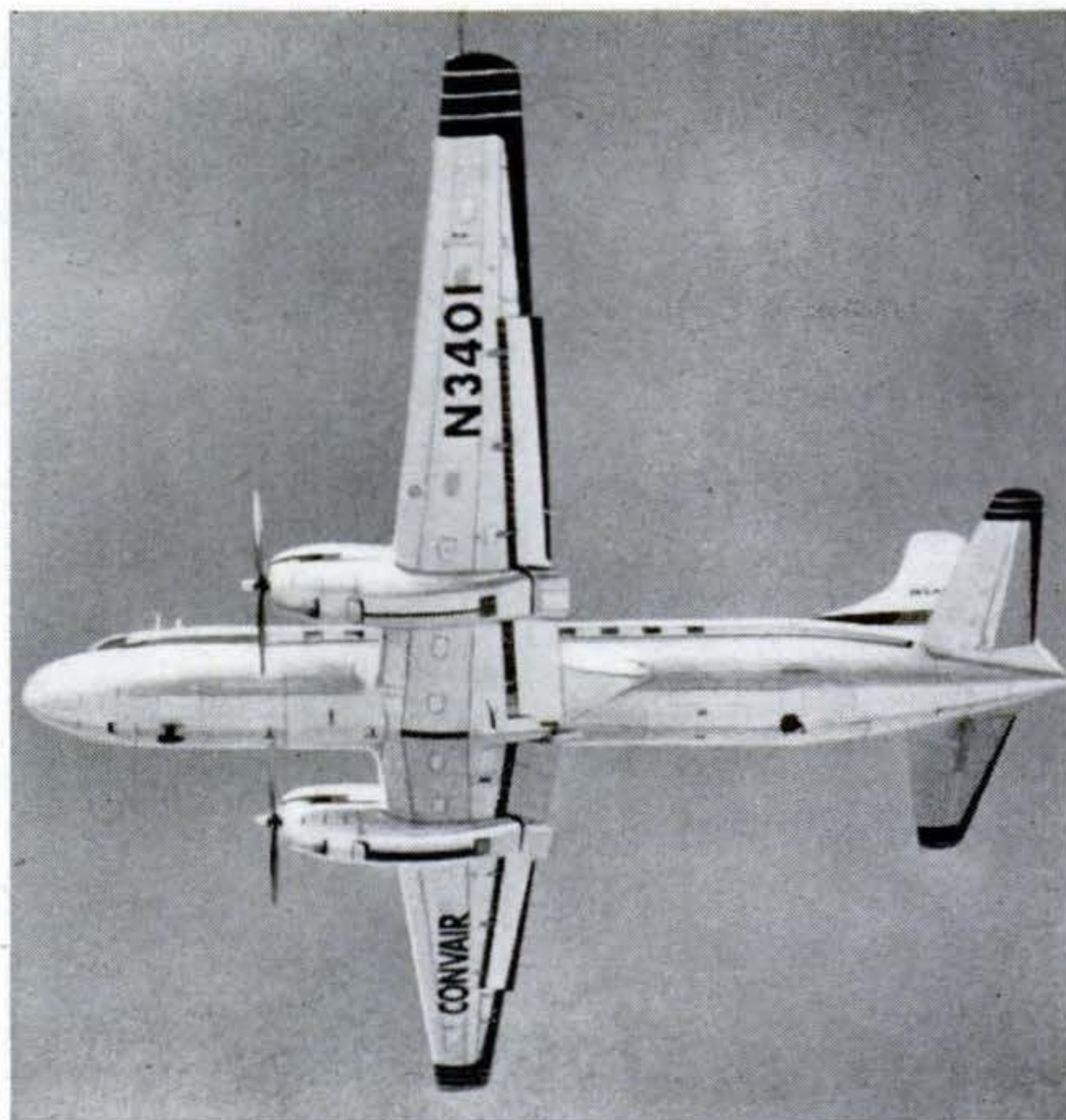

Visor Deflects Rain

THIS plastic visor cuts side glare and lets you drive with window open even in the rain. It is made by Tenna-Lite Corp., Chicago.

'52 Pontiac Has New Power Train

**A third-gear range
on Hydra-Matic lets you
pick the rear-axle ratio.**



By Harry Walton

PONTIAC, in 1952, offers a new Hydra-Matic drive that gives the motorist back a piece of the shift lever he lost with the clutch. He'll be able to scoot along in a higher, gas-saving fourth gear, and shift to third at the flip of a finger when the car crests a hill. He will, in effect, have a choice between two rear-end ratios.

Previewed by Wilbur Shaw last year (PS, Oct. '51, p. 128), the Dual-Range Hydra-Matic makes its bow as optional equipment on the 1952 Pontiacs. Also new are a high-compression head and a low-ratio rear axle.

With the improved drive, Hydra-Matic users need not choose between coasting downhill in fourth and using the brakes heavily, or shifting to Low range. The latter meant shifting from fourth gear to second,

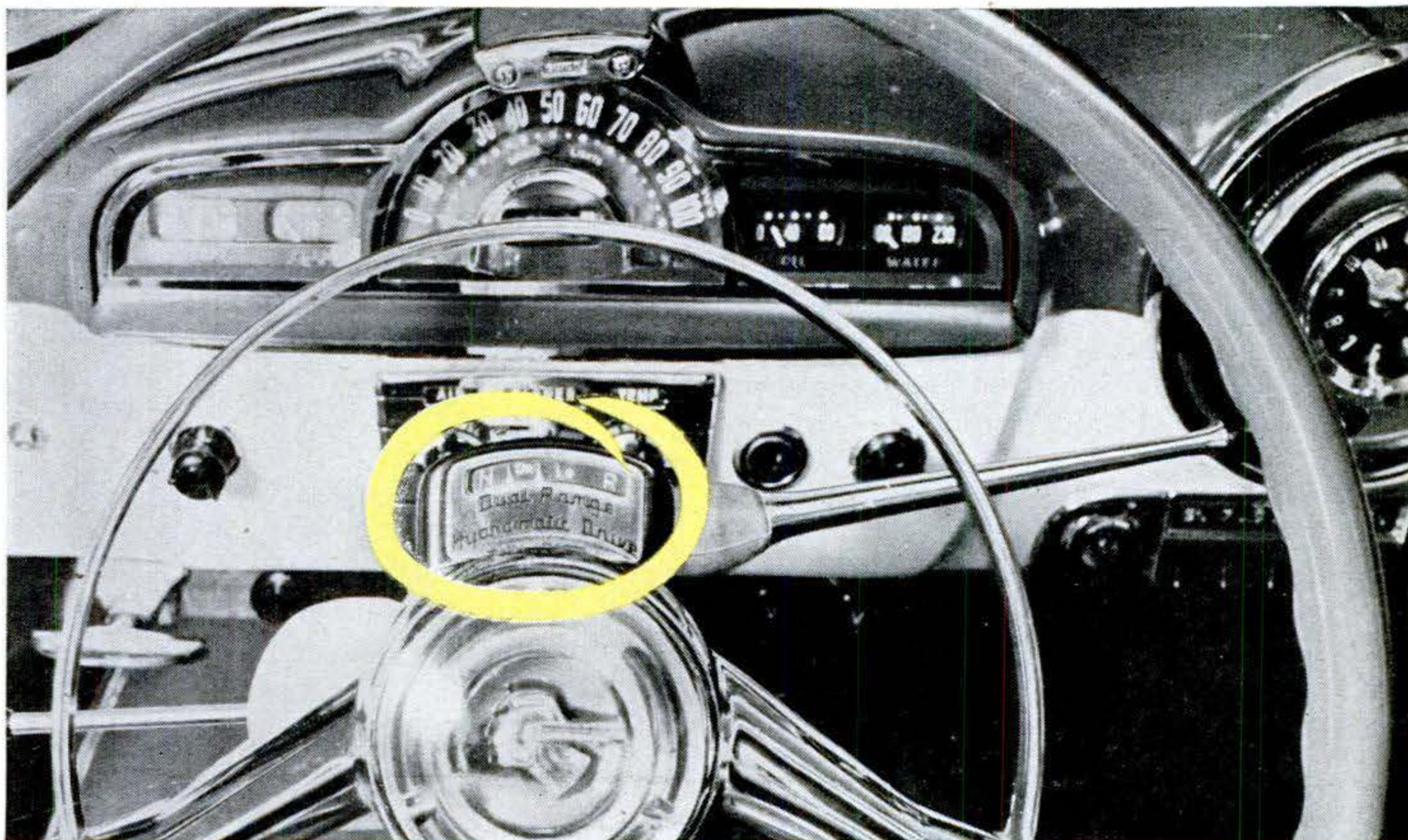

Two arrows flanking Drive position on the selector quadrant are tip-off to Dual Range.

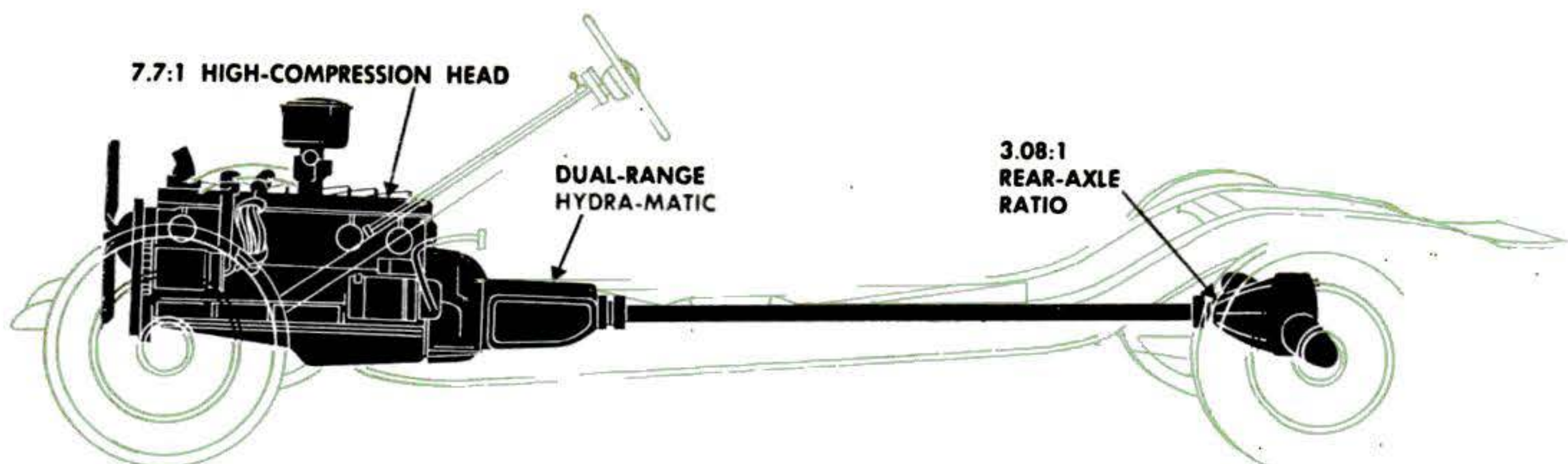

In fourth gear, low rear-axle ratio gives smooth cruising speed similar to that of overdrive.

which made the car "pile up" against the engine and induced skidding, besides adding too much engine drag for highway grades.

Now, you just nudge the selector lever from the left side of the Drive position to the right. The transmission will shift to third gear instantly, and will not go back to fourth until you move the selector lever back.

This optional third-gear position makes possible a lower rear-axle ratio—3.08 to 1 instead of 3.46 to 1. In fourth gear, which is a straight-through 1 to 1 drive, this low ratio amounts to an overdrive. The shift to third instantly drops the over-all ratio to 4.46 to 1.

Tramp on Gas for Other Shifts

Downshifting to third is also possible, at speeds below 60, by floorboarding the gas pedal. In the right-hand Drive position, at speeds below 20 miles an hour, tramping on the gas makes the transmission shift to second. A larger detent lets the driver feel the downshift point more clearly.

Also new is the action in Low range. The car starts—and stays—in second gear when the selector lever is at Low. This makes for surer starting on ice. Tramping on the gas below 10 m.p.h. will shift to first gear.

An exhaust valve added to the rear servo unit facilitates the shift from low to reverse, making it easier to rock the car in snow or mud.

As part of its Hydra-Matic power package, Pontiac specifies a new 7.7:1 high-compression head, said to boost maximum horsepower of the six to 102, and of the eight to 122. Engines with this head require premium fuel. The 1951 high-compression head gave a ratio of 7.5:1.

The compression ratio of the standard Pontiac head, recommended for Syncro-Mesh shift, has also been upped from its 1951 figure of 6.5 to 6.8:1.

Minor engine changes include improved spark plugs and a redesigned generator, with a new lubrication system that is said to prevent the danger of over-oiling.

Wheel disks, the trunk handle, hood ornament and radiator grille are of new design. Some new upholstery and body colors will be offered, including three color combinations in trim in the De Luxe models. Extras include tinted safety glass all around and a motor-driven radio antenna. **END**



75 years ago this month

Popular Science Monthly reported:

"THE loss, in 1875, to Russia, from the ravages of wolves, amounted to about 15,000,000 rubles. The number of cattle killed was 179,000; of sheep, etc., 562,900. In the government of Kalouga alone the wolves killed 8,200 geese and 2,000 dogs. The human lives destroyed by the wolves are estimated at 200 per year."

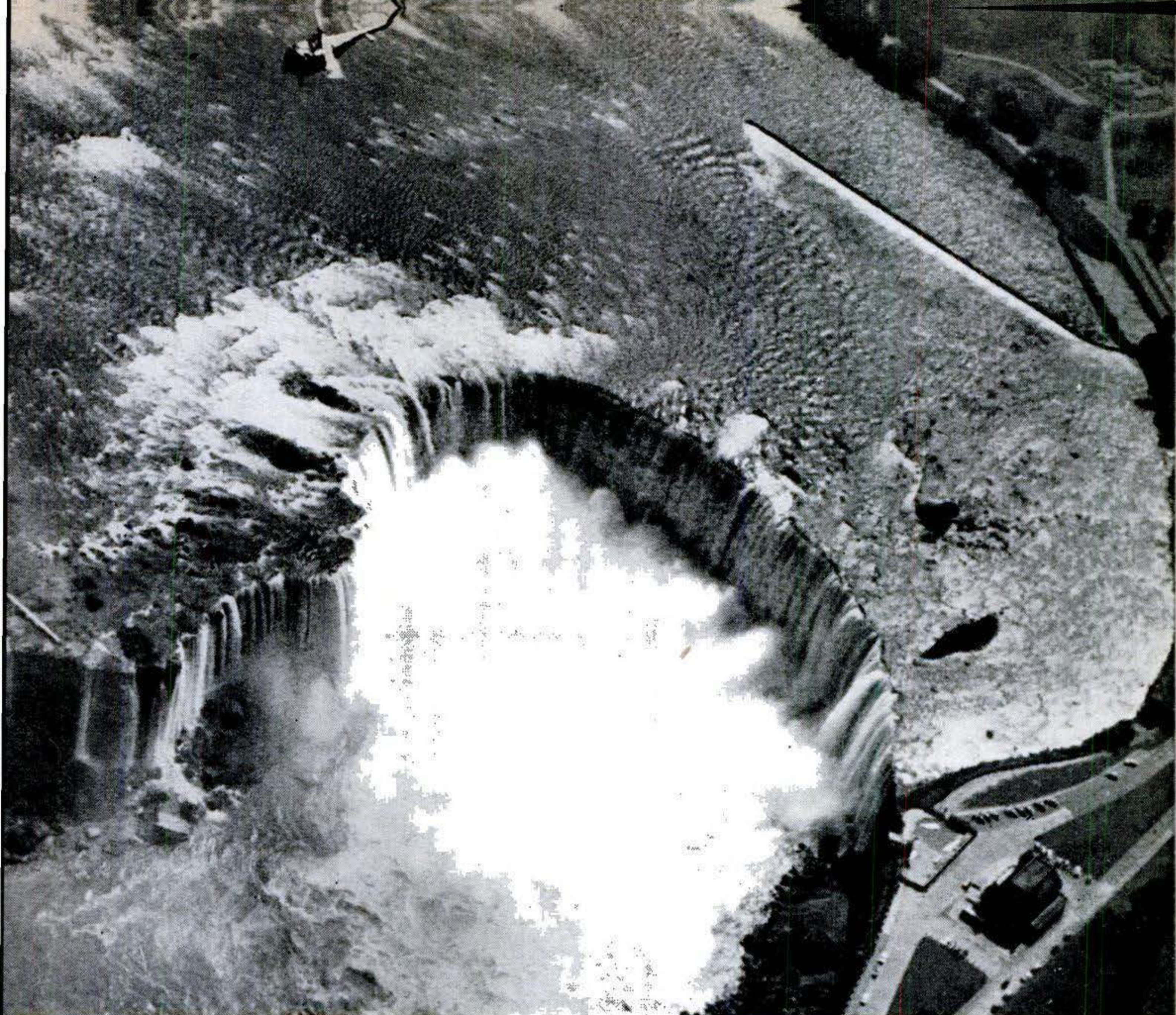

Niagara's familiar face will look the same even though less water will flow over it.

How Niagara Falls Will Work Nights

U. S. and Canada plan to squeeze more power from the scenic attraction by siphoning off some water when the tourists aren't around to see.

By George H. Waltz, Jr.

THEY'RE going to run the Niagara River through a "faucet" to generate enough extra electricity to serve the needs of five million U. S. homes. Canada's homes and industries will benefit in a big way, too.

Although this new project means tampering with the flow of water over Niagara Falls, nobody's honeymoon is going to be spoiled, for it will be done mostly when few sightseers will be around.

The proposed faucet will actually be a dam with control gates, located either a short distance above the Falls or where Lake Erie spills into the Niagara River, at Buffalo. New hydroelectric plants on both banks of the river (which at this point is the boundary between the two countries) will turn the extra water power into electricity to meet the rising demands of both the United States and Canada.

About a year ago, the two countries decided they could siphon off some water

from Niagara Falls without spoiling its looks. When the rainfall is normal, some 170,000 cubic feet of water goes over the Falls each second. Experts agreed that was around 70,000 cubic feet a second more than it needed to look pretty.

After making careful surveys and tests, including experiments with scale models of the Falls, U.S. and Canadian engineers decided to cut the flow to 100,000 cubic feet a second during the daytime in months when people flock to see the famous show. At night and during the time of the year when tourists aren't on hand, they plan to clip it to 50,000 cubic feet a second. The rest of the water will be diverted and used ingeniously to make more electricity.

U. S. Water Bonus Is Big

The U.S. share of this prized dividend of water will boost our generating capacity at the Falls from the 440,000 kilowatts we have now, provided by two fairly small hydroelectric stations, to at least 1,572,000 kilowatts. We plan to build a super hydroelectric plant at Lewiston, N.Y., on the Lower Niagara River six miles downstream from the foot of the Falls.

The plant will have two banks of turbine-driven generators—six 20,000-kilowatt units and twelve 90,000-kilowatt units. They will get their water by separate routes. The 20,000-kilowatt units will draw on the Lower Niagara River below the Falls. Here water will enter a tunnel 42 feet in diameter and a little more than three miles long and be pushed along to a surge basin at the Lewiston power plant. There the 20,000-kilowatt generators, operating under a 100-foot head of water, will turn out 120,000 kilowatts of electricity.

Reservoir to Cover 850 Acres

The 90,000-kilowatt units will get their water from two sources—the Upper Niagara River and an unusual 850-acre storage reservoir which will be built a mile east of Lewiston. Tunnels five miles long or canals somewhat longer will bring water from a point a few miles above the Falls to a surge basin at the power plant, where it will provide an operating head of 315 feet.

By a clever arrangement, the huge storage reservoir, which is to have a plant that can both pump water and generate electricity, will use power when there is power to burn and then furnish both water and electricity when they are most in demand.

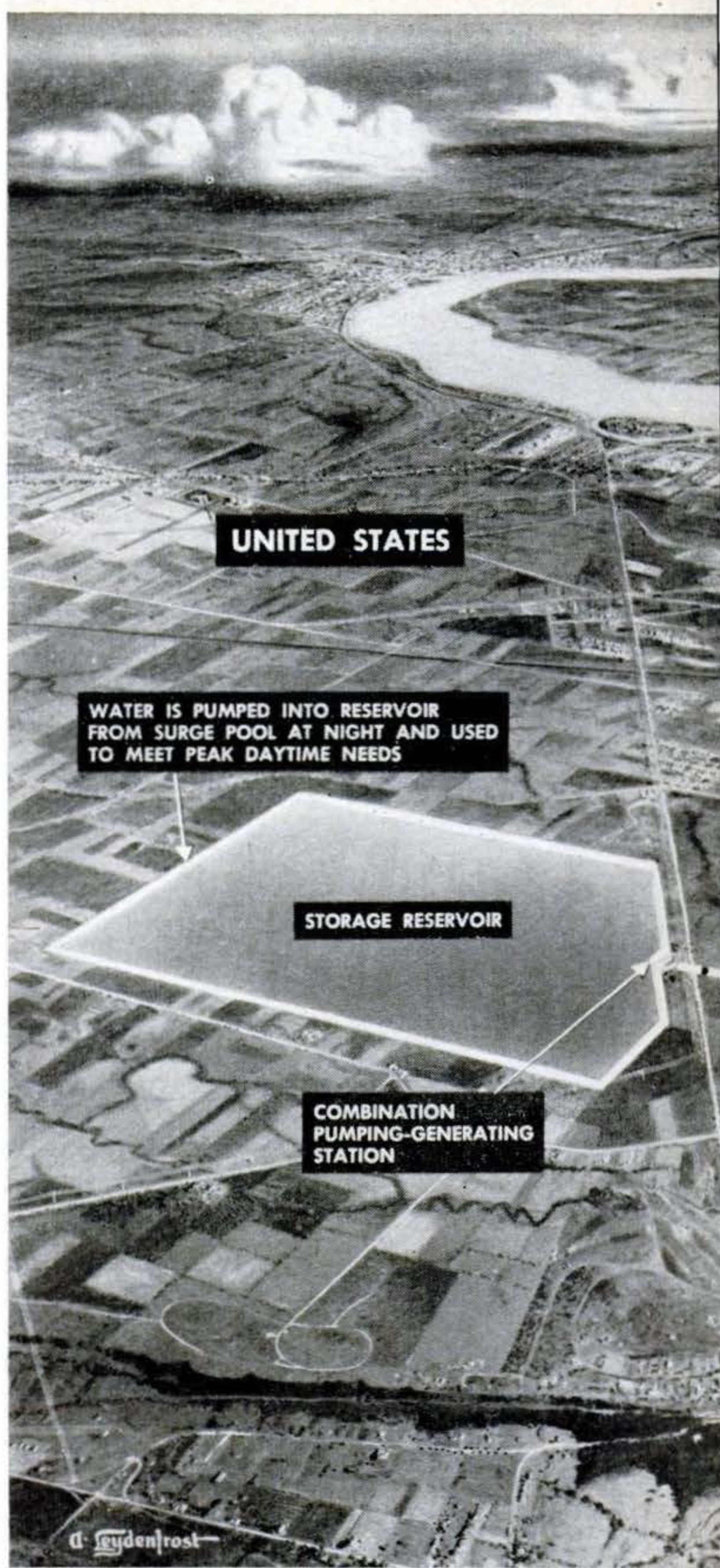

This drawing shows how and where the United

At night and over week ends, when factories generally are not running and it will be all right to tap the Upper Niagara to the limit, the pumps will suck up as much water as the reservoir will hold. During the daytime on weekdays, the stored water will be doled out through the reservoir's pumping-generating units as needed, serving two purposes. Under an average water head of 60 feet, it will generate up to 130,000 kilowatts of electricity. It will then be

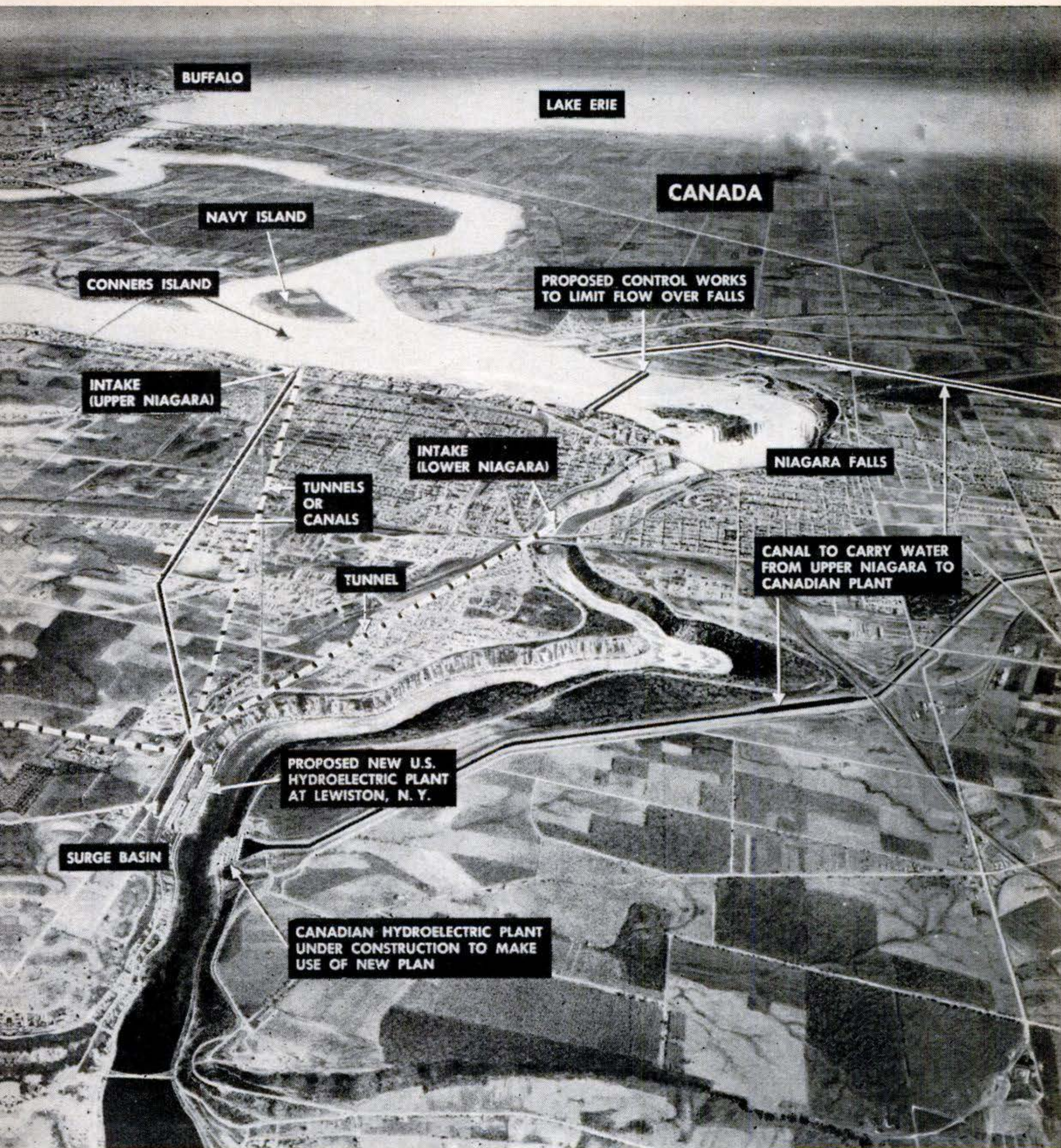

States and Canada will tap the Niagara River to get more electricity for both nations.

fed to the main Lewiston power plant to help drive the 90,000-kilowatt generators.

Canada is already at work on its part of the big new power project. What the United States has cut out for itself will cost about \$350,000,000 to build if tunnels are used to bring water to the Lewiston plant, somewhat less if canals are used. But the experts say that it will pay off with around \$61,000,000 worth of much needed electric power every year.

END

When to Do What

THERE'S a secret to keeping up a home: *timing*. What's the best time to check for fire hazards? To inspect the hot-water tank? To cut posts? Turn to page 171 for POPULAR SCIENCE'S new—

Home Handyman's Calendar



Piston Rings on New Chrysler to Lengthen Engine Life

SIX-CYLINDER models of the 1952 Chrysler, announced last month, have new chromium-plated top piston rings to eliminate scuffing and reduce cylinder-bore wear by as much as half. A new type of oil ring, giving better oil control, is expected to add considerably to the life of the engine. Horsepower has been boosted from 116 to 119.

The new line of Chryslers looks much like its predecessor. Above: the eight-cylinder New Yorker four-door sedan. Wheel covers and tail lights have been restyled. Tinted windshields and windows are available at extra cost. Power-assisted steering can now be purchased as an extra on Windsor six-cylinder models.

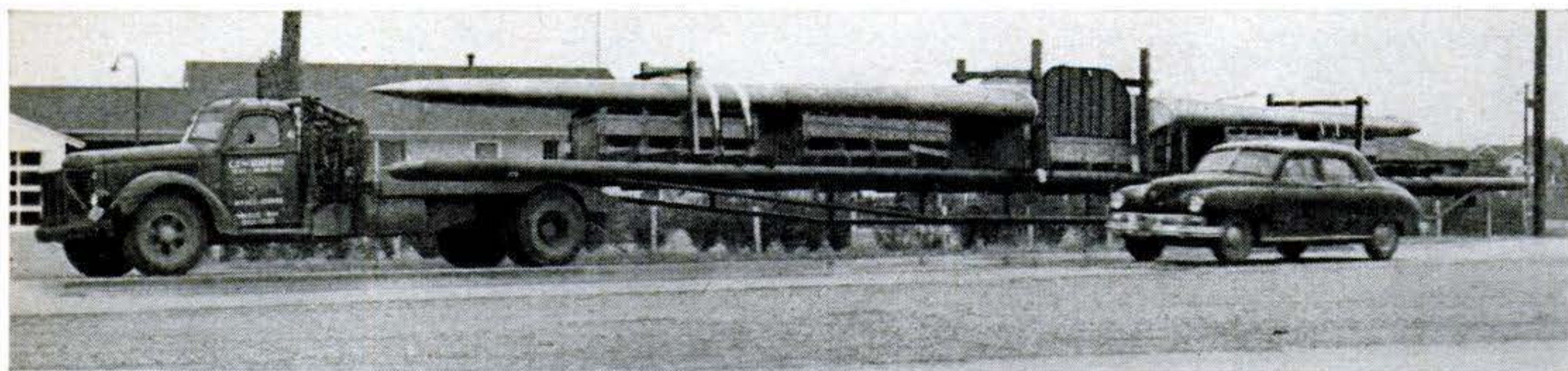

Big Trailer Hauls Plane Tail

THIS trailer is so long that a helper must run back and adjust the rear wheels whenever the driver wants to turn. Its owners

had to get a special state ruling before the overlength, 91-foot unit could roll on Texas highways, hauling horizontal stabilizers for huge B-36s to the Convair plant.

British Building New Helicopter-Plane

ENGLAND'S version of a helicopter-airplane is the Fairey Rotodyne, shown in artist's sketch at right. Main power will come from gas turbines turning propellers. Air bled from the turbines will be fed to rotor-blade tips where it will be ignited in auxiliary ramjet units. The rotors will supply emergency power and give the aircraft a steeper take-off.

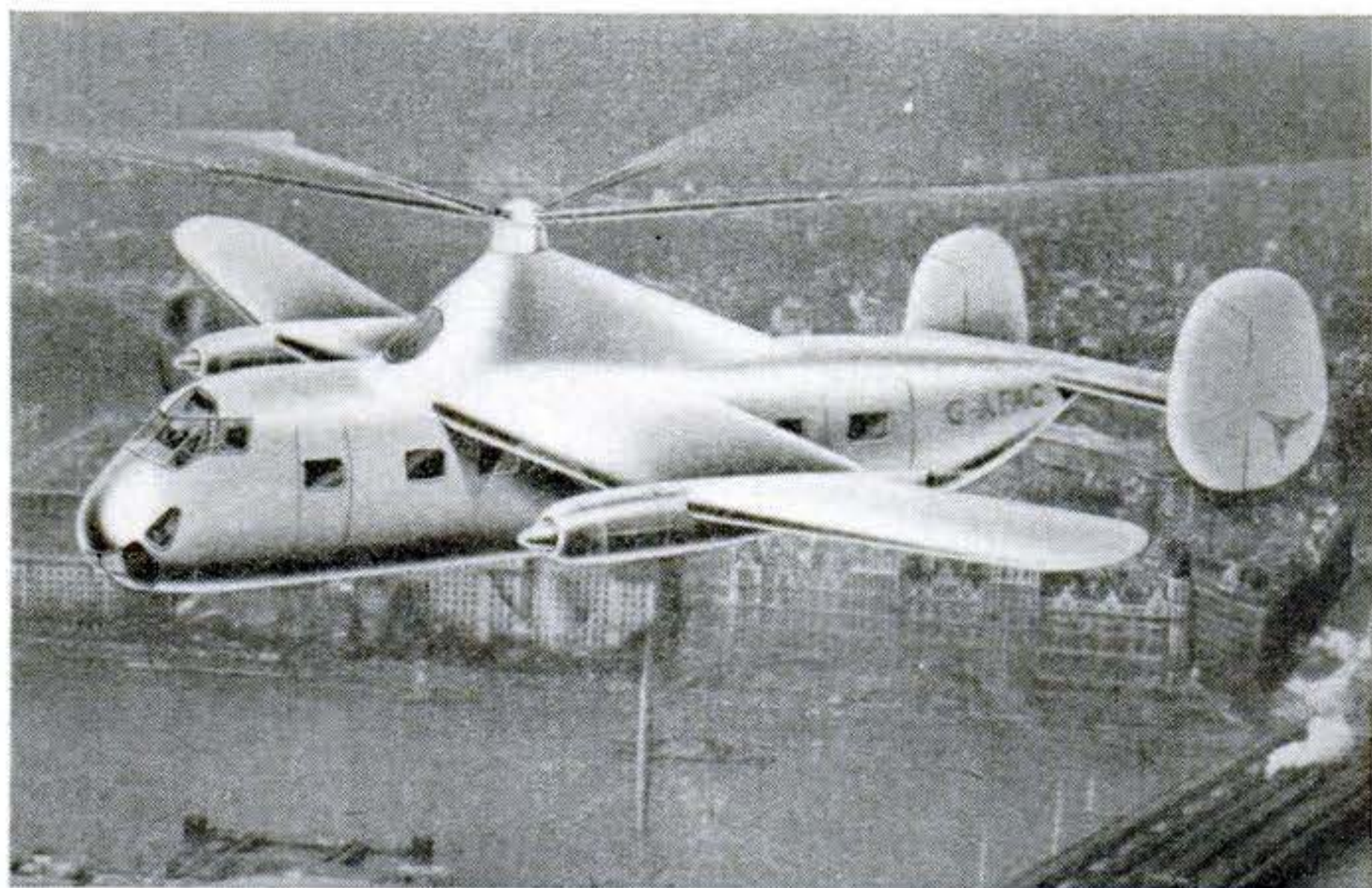

Tiny Fire Truck Guards New Cars

A MIDGET fire truck stands guard against any outbreak of fire as these new cars are filled with gasoline in Ford's Dearborn assembly plant.

Because of its small size, the fire truck can be driven right into the building. It is similar to the trucks used to haul materials in factories, but here carries an assortment of extinguishers including two Kidde CO₂ units.

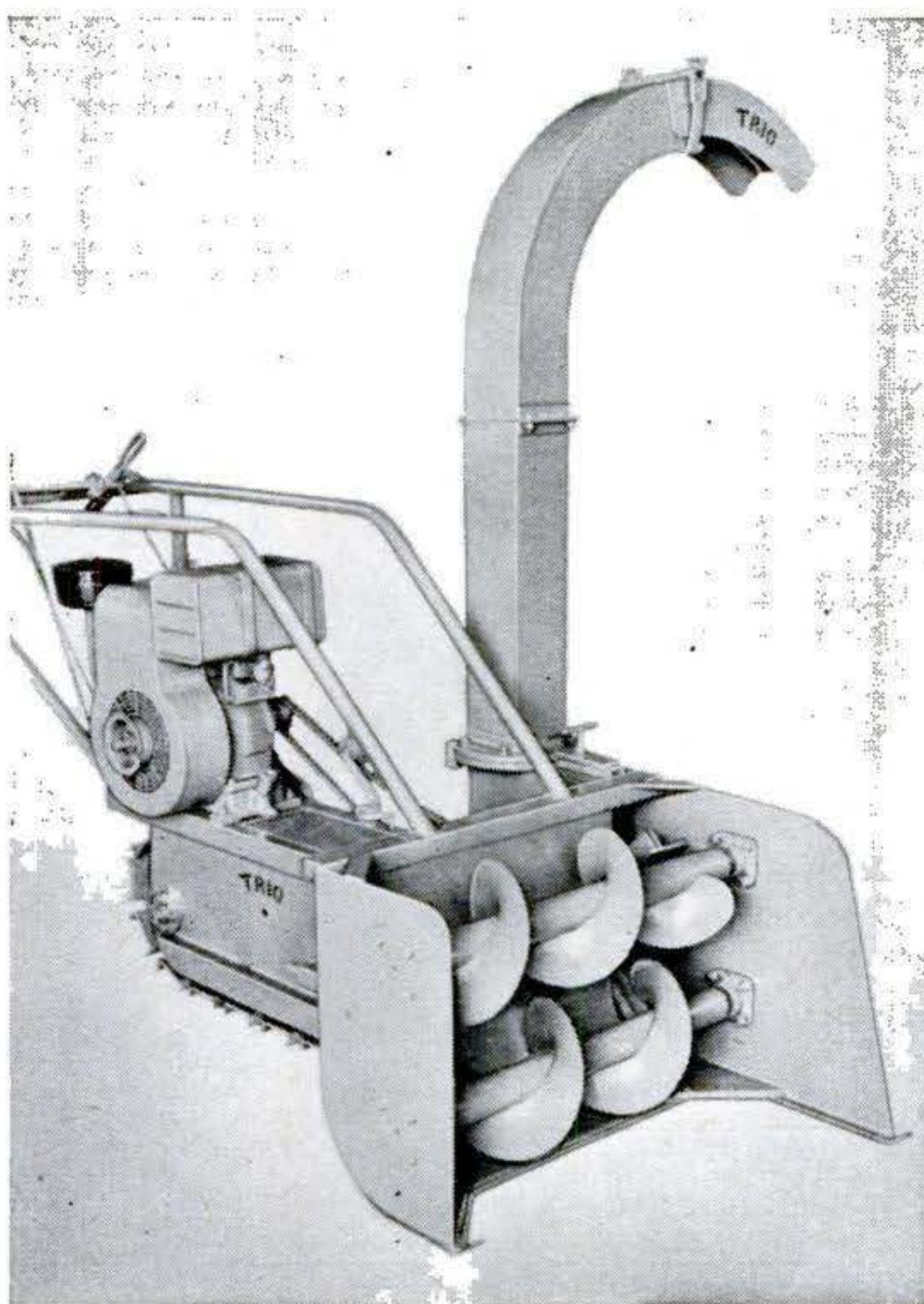

Crawler Plow Blows Snow Away

THIS husky snowplow on a caterpillar track cuts a 30-inch swath through the deepest drifts—and all the operator has to do is guide it by the handlebars. Powered by a 7.7-hp. gasoline engine, the plow has a blade across the front that scoops up the snow and rotating augers that bite into it. A fan blows the snow away through a six-foot spout that can be swiveled in any direction. Dahlman Equipment Sales Co., St. Paul, Minn., sells the plow.



Wooden Track Frees Mired Car

THIS heavy wooden track, tossed in front of the wheel that's spinning, gives the traction needed to free a car bogged down in snow, mud or sand. The Consolidated Equipment Corp. of Cleveland makes it.

Rod to Halt Rust in Car Radiator

THE metal rod at right is intended to be put in a car radiator to prevent rust from forming and keep water sweet and clean. The manufacturer reports that in a few weeks scale will begin to drop away. Then when the radiator is flushed, water remains clear. In a new car, any scale that forms becomes sludge that drops to the bottom. The maker, McRay Products Co., Los Angeles, claims galvanic action does the job.



New Tug Pushes Floating Train

OL' MAN RIVER is to see something new—fast streamlined “trains” afloat. Tank barges for petroleum products, and a towboat that pushes them, have been especially designed to form an integrated unit. To make up a 1,180-foot “train,” four barges fit together end to end, and “wings” or fairing hulls extend from the aftermost barge around the prow of the towboat. Developed in model-basin tests by Lake Tankers Corp., New York, the floating streamliner’s design minimizes water resistance and boosts speed against the current. The first of the towboats, the *Delta Cities*, has just been launched at St. Louis.

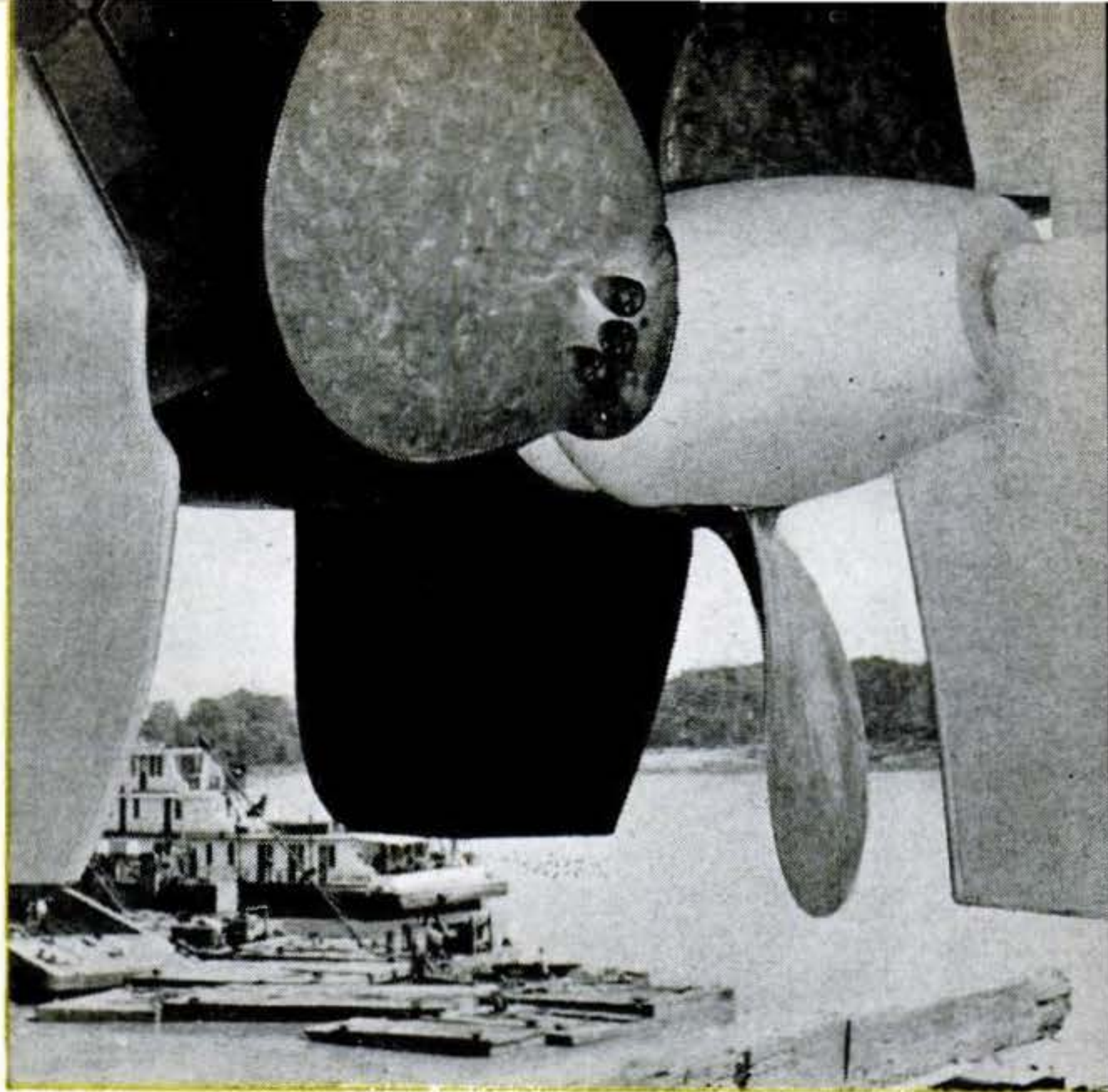

PRELAUNCHING VIEW shows one of nine-foot-diameter, stainless-steel twin screws, believed largest of variable pitch in U. S., that propel 3,200-hp. Diesel towboat *Delta Cities*.

Tower Jounces Plane Parts

ENOUGH cocktails for a regiment could be shaken at once in the 40-foot tower (left) that tests big fuel tanks and other aircraft parts. It can jounce 3,000-pound pieces 15 times a second as far as five feet. The big bumps come from elastic shock cords actuated at top and bottom by pistons driven with compressed nitrogen gas. Built by Bell Aircraft Corp., Buffalo, N.Y., the tower is the first of its kind.

Binoculars Fit Over Glasses

DESIGNED for people who wear glasses, the binoculars below have a forehead rest giving ample clearance. The optical system is suited to that position—so that the field of view is not reduced, as it is when an eye-glass wearer is forced to hold ordinary binoculars away from his eyes. The maker is Barnet Ensign Ross Ltd., London.





STREAMLINED "TRAIN" to ply Mississippi consists of four barges and towboat pushing them. Prow of towboat fits between "wings" flexibly joined by pins to barge ahead. Since

train will be 1,180 feet long, it will need a microphone at forward end to pick up whistles of oncoming craft, with wires leading back to loudspeaker in pilot house of towboat.

Drill Races Through Plastics

LIKE a hot knife in butter, a new drill with a straight round shaft sinks right through plastics. It far outspeeds and outlasts the conventional drill shown below it at right, which must be fed slowly to avoid overheating. The new drill was designed by Robert Double, Westinghouse engineer.

Builds His Own Sports Car

INTO the sleek job below went a Mercury engine, a Lincoln transmission, Ford wheels, a Chevrolet gas tank, an aircraft instrument panel, about \$1,100 and two years' spare-time work by Bill Houk, Boeing Aircraft machine-shop foreman at Wichita, Kan. He built the body himself. The 160-horsepower car will do 110 miles an hour.

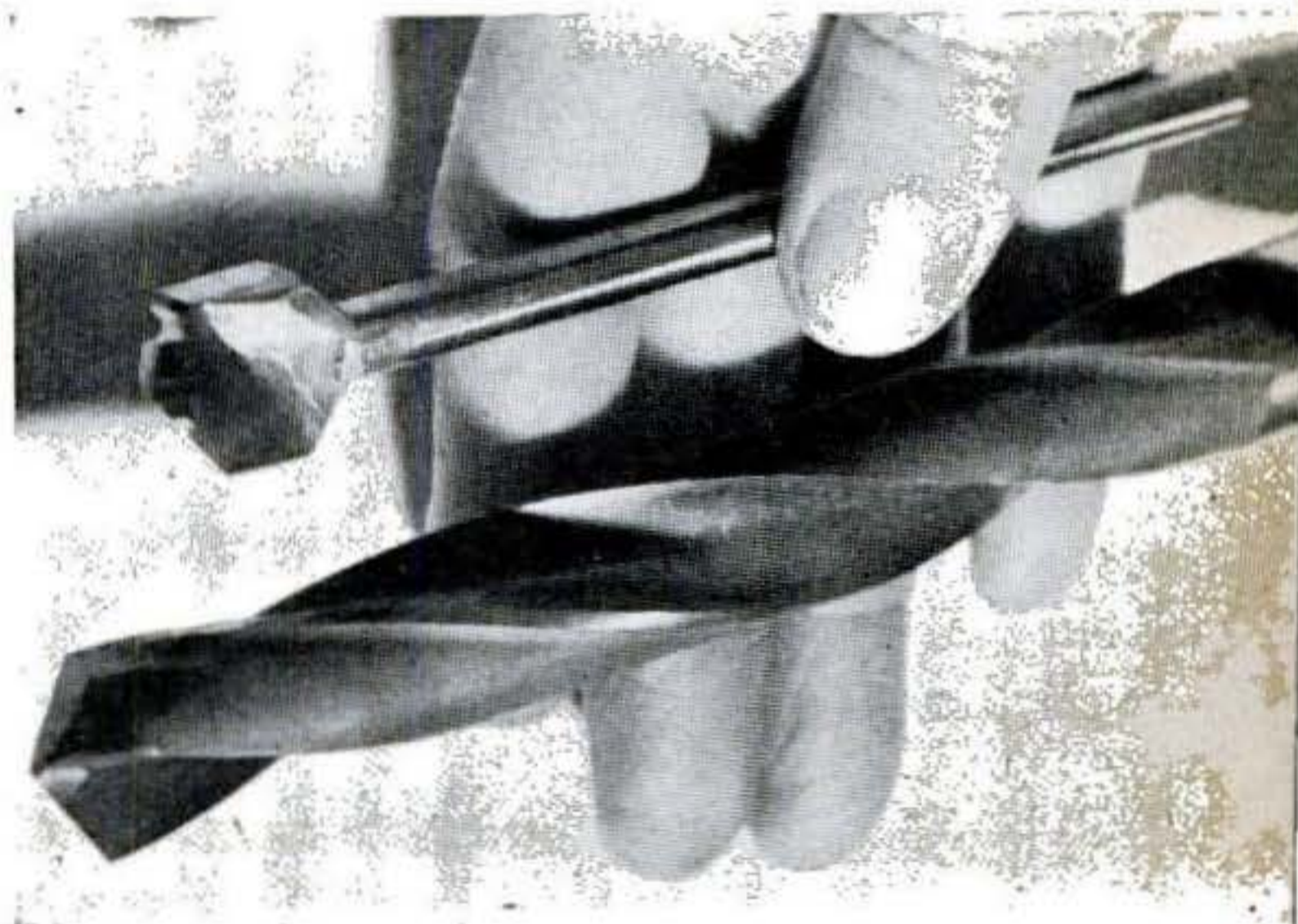

Railroading at 72° Below

Bazookas and steam-heated tunnels help to keep the freight rolling over strategic line to Fairbanks.

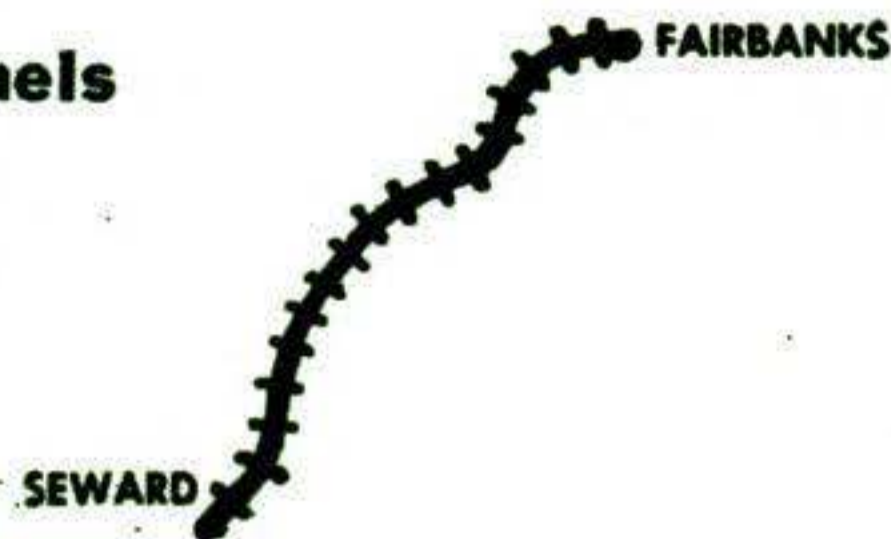

By Herbert Yahraes

TEMPERATURES that drop as low as 72° below zero at this time of year and snowfalls that may total 50 feet for the season often delay—but never stop—the Alaska Railroad.

Some of its main problems and how it meets them are shown on these pages.

Only two remain unsolved. One is the problem of the immovable moose—see below. The other is the moving mountain—a vast, shifting mass of rocks over which an 11-mile stretch of line has to be rebuilt each year.

Newest weapon used against the moving mountain is the bazooka. When a rock

slide buried 165 feet of track and left an overhanging cliff that looked as if it would topple on the track at any moment, the railroad—run by Uncle Sam—called on the Army for help.

Bazooka teams poured rockets into the cliff to bring down the dangerous-looking overhang so cleanup crews could safely clear the tracks. Instead, the bombardment proved that the rock was going to stay up there a good long time. Two days later the line was clear.

The Army's help symbolized the Alaska Railroad's high strategic importance. It is now hauling more freight across 500 miles of our northern outpost than it did even during the peak years of World War II.

MOOSE ON THE TRACKS (below) often block traffic. They get on the snow-cleared right of way and refuse to leave. One theory holds that they think the locomotive is a big wolf—which they can outrun only in the open. Last winter trains killed more than 175 moose.

STEAM-HEATED TUNNELS carry Alaska Railroad through half a dozen mountains. Gatekeepers swing huge doors open to let trains enter and leave. Steam pipes from a boiler prevent seepage from freezing into giant icicles that would shake loose and drop on cars.

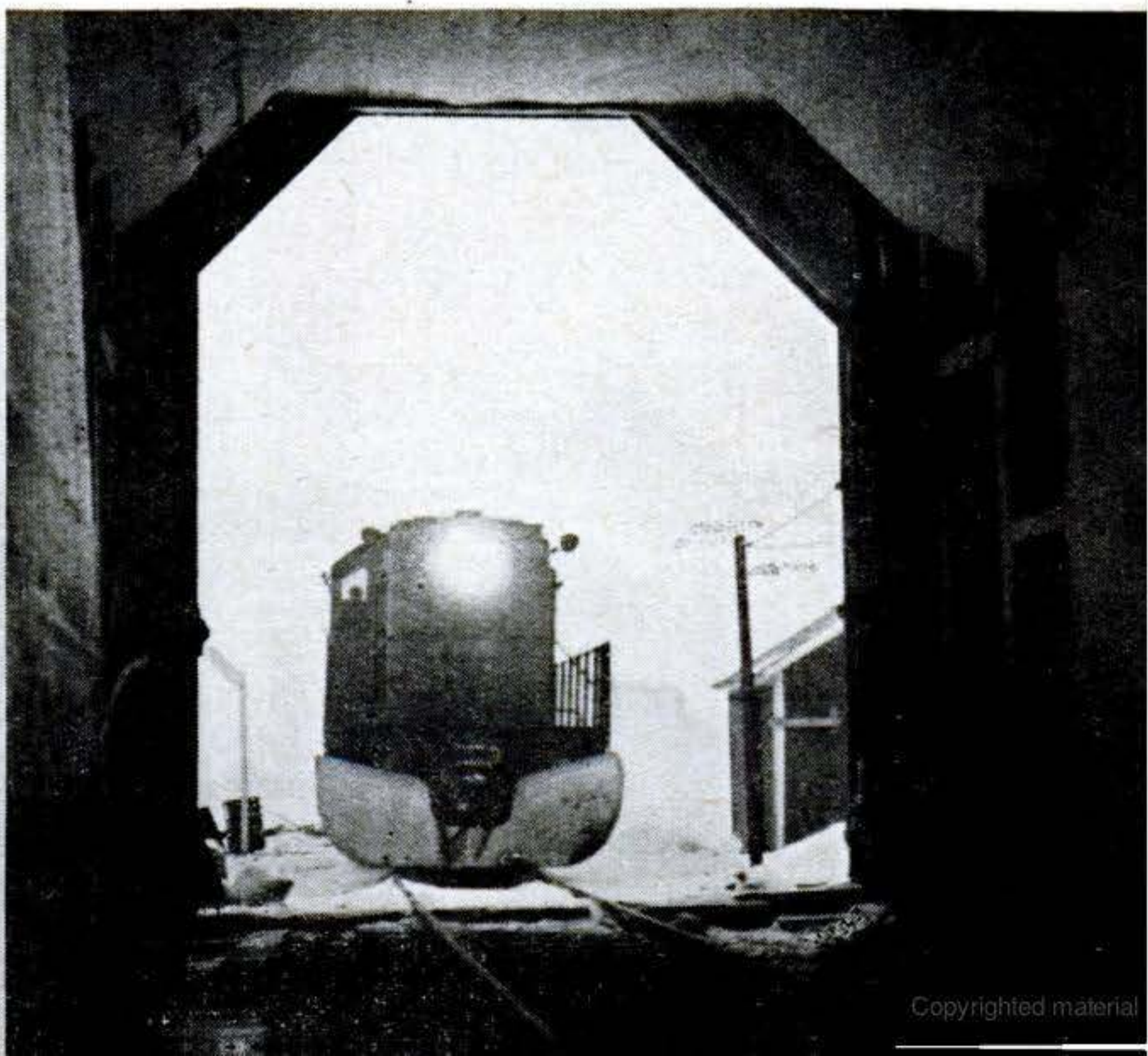
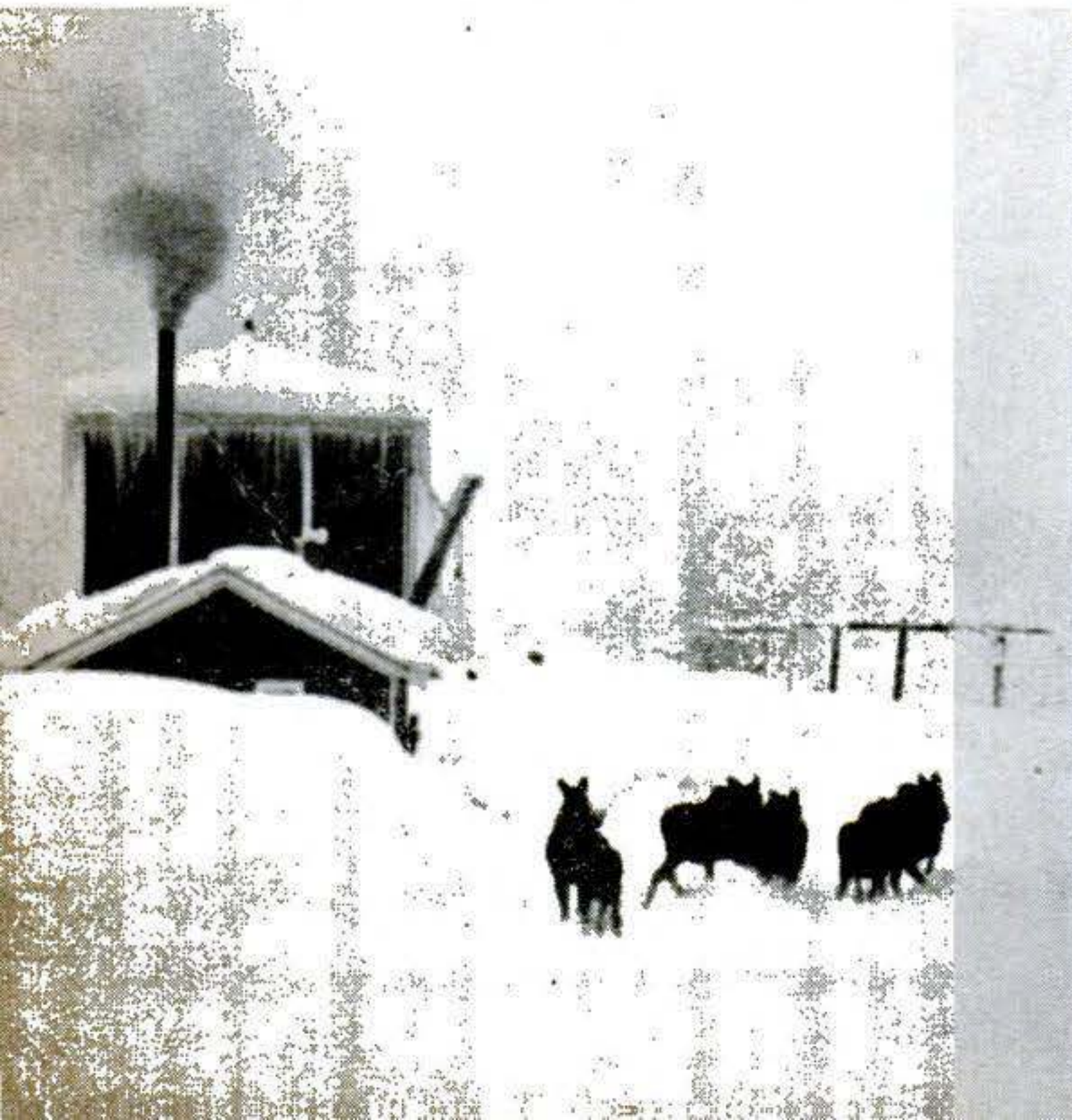



SNOW SLIDES buried three men alive when they tried to escape from the snowbound freight above. Here a gang of men digs them

out. A trainman, William R. Shake, won the Distinguished Service Award, the Department of Interior's highest honor, for this rescue job.

HEAVY SNOWS—50 feet may fall in a season—crushed the roof of this warehouse in the terminal yards at Anchorage. In some spots where the line runs along mountain valleys, huge snowsheds have been built to carry avalanches over the tracks. In unprotected sec-

tions bulldozers, and snowplows propelled by locomotives, are used to clear away the snow. Sometimes a snow slide rips up wire lines along the route, disrupting communications and causing expensive delays.

(Continued on next page)



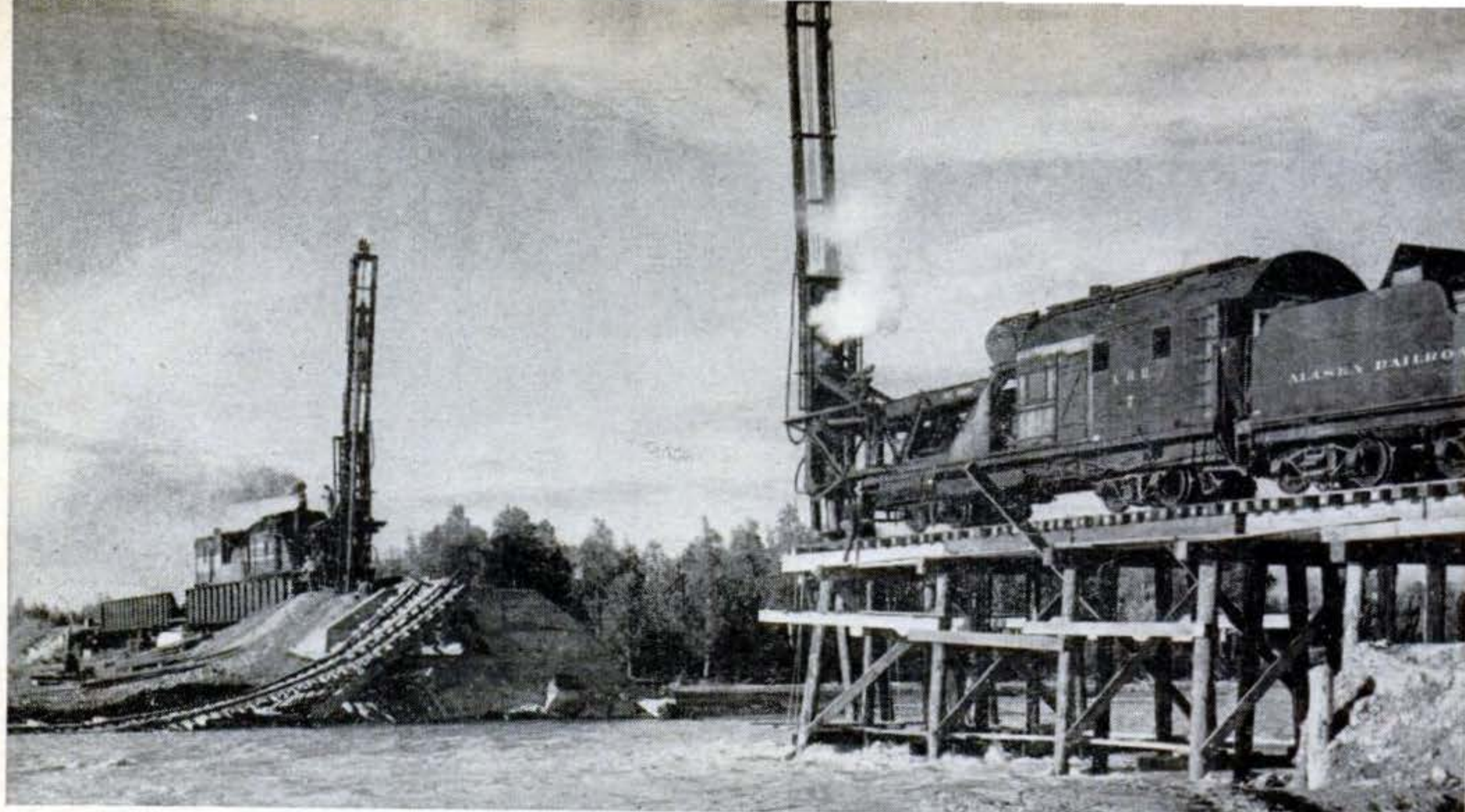

FLOODS swept away the Kashwitna River bridge, shown being rebuilt by pile drivers above. Spaces between ties on a span like

this are often covered with metal plates to prevent moose—who like to run on the tracks—from breaking their legs.



AVALANCHES that drag along trees and rocks are cleared away by bulldozers. Machine above works on a slide far up the mountain to prevent it from descending on the tracks.



SIXTY-FOOT PILINGS, pounded into the road-bed at an angle (above), help to support track on thawing mountain as soil shifts. This section of track has to be rebuilt each year.



A ROCK SLIDE in the area of the moving mountain blocks 165 feet of track. To prevent another such slide, Army bazooka teams blasted

away at an overhanging rock cliff. Rock stayed in place, proving that cliff would hold and it was safe for crews to clear tracks.

New Ideas from the Inventors

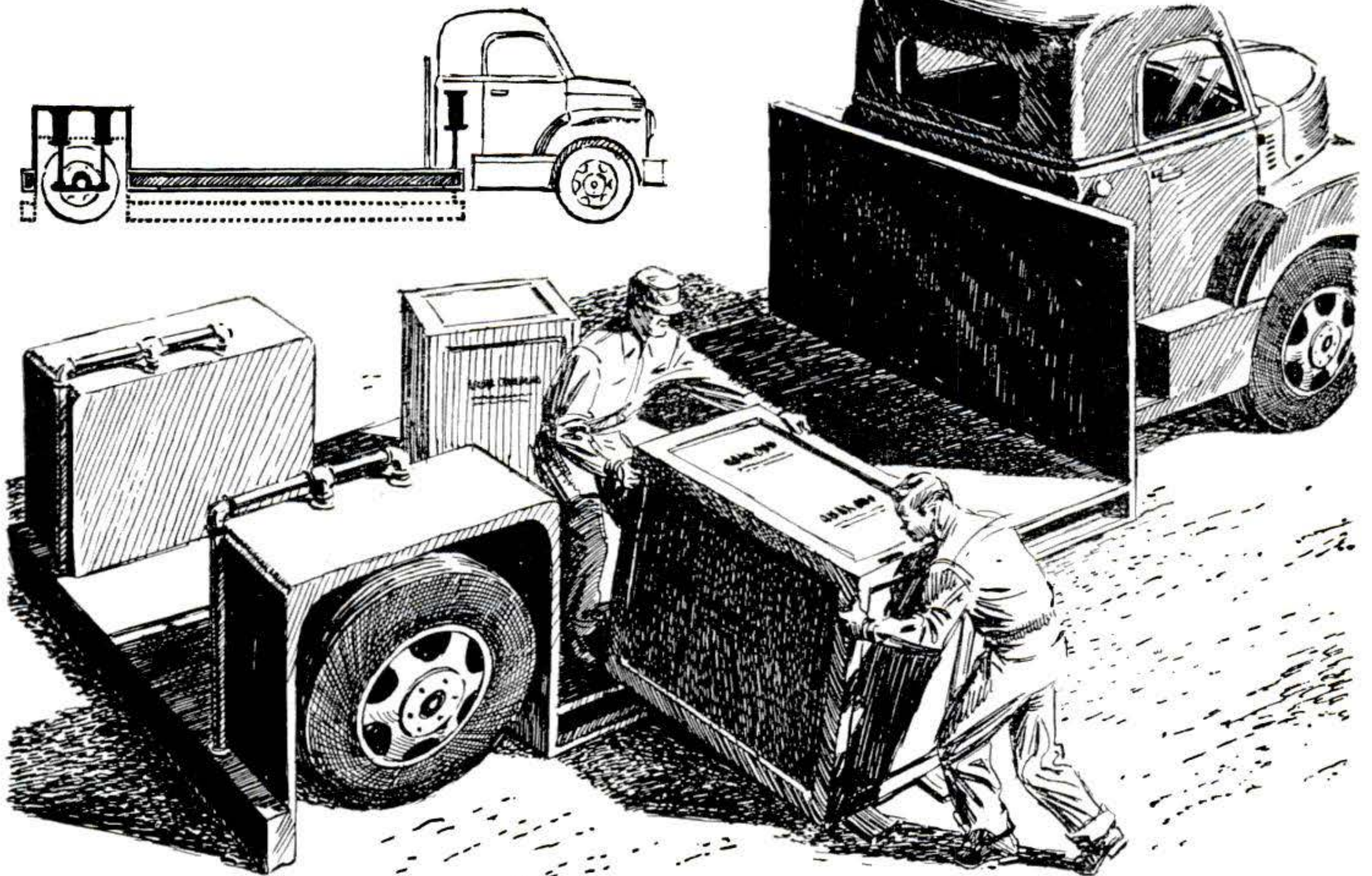

1 Truck Body to Lower. To avoid raising heavy cargo up to a truck, this invention would bring the truck right down to the cargo. A hydraulic system, controlled by a button in the cab, would lower the entire

truck body to curb level for easy loading, then raise it for road travel. Front-end-drive eliminates a driveshaft that would otherwise get in the way. The body could be locked at any level.

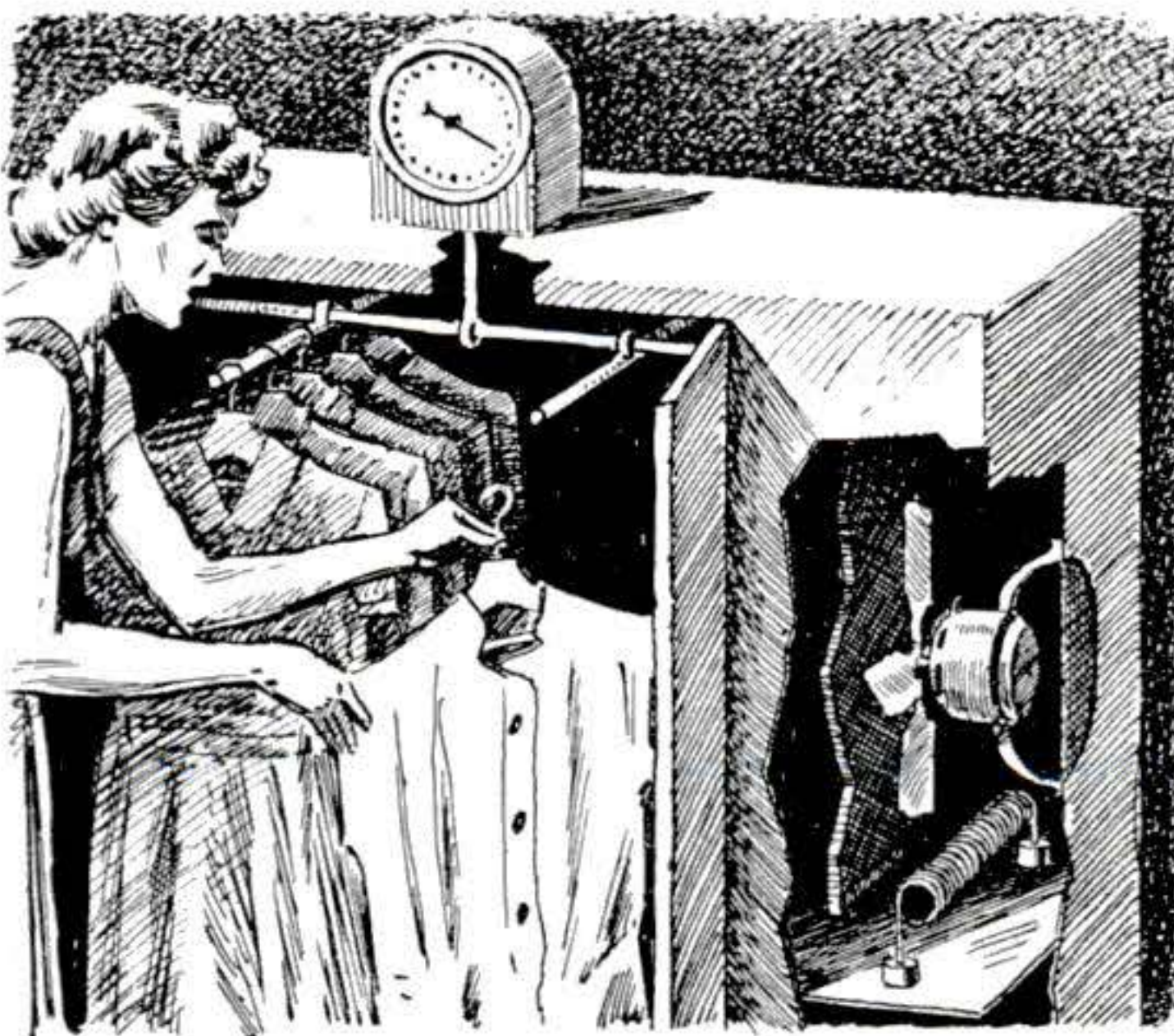

2 Drier to Weigh Clothes. A housewife would have no trouble wondering when to take the clothes out of this laundry drier. A sensitive scale, connected to the rods holding the clothes, would weigh the garments as water was removed to show when they were dry. The drier would combine heating elements with a fan to circulate air.

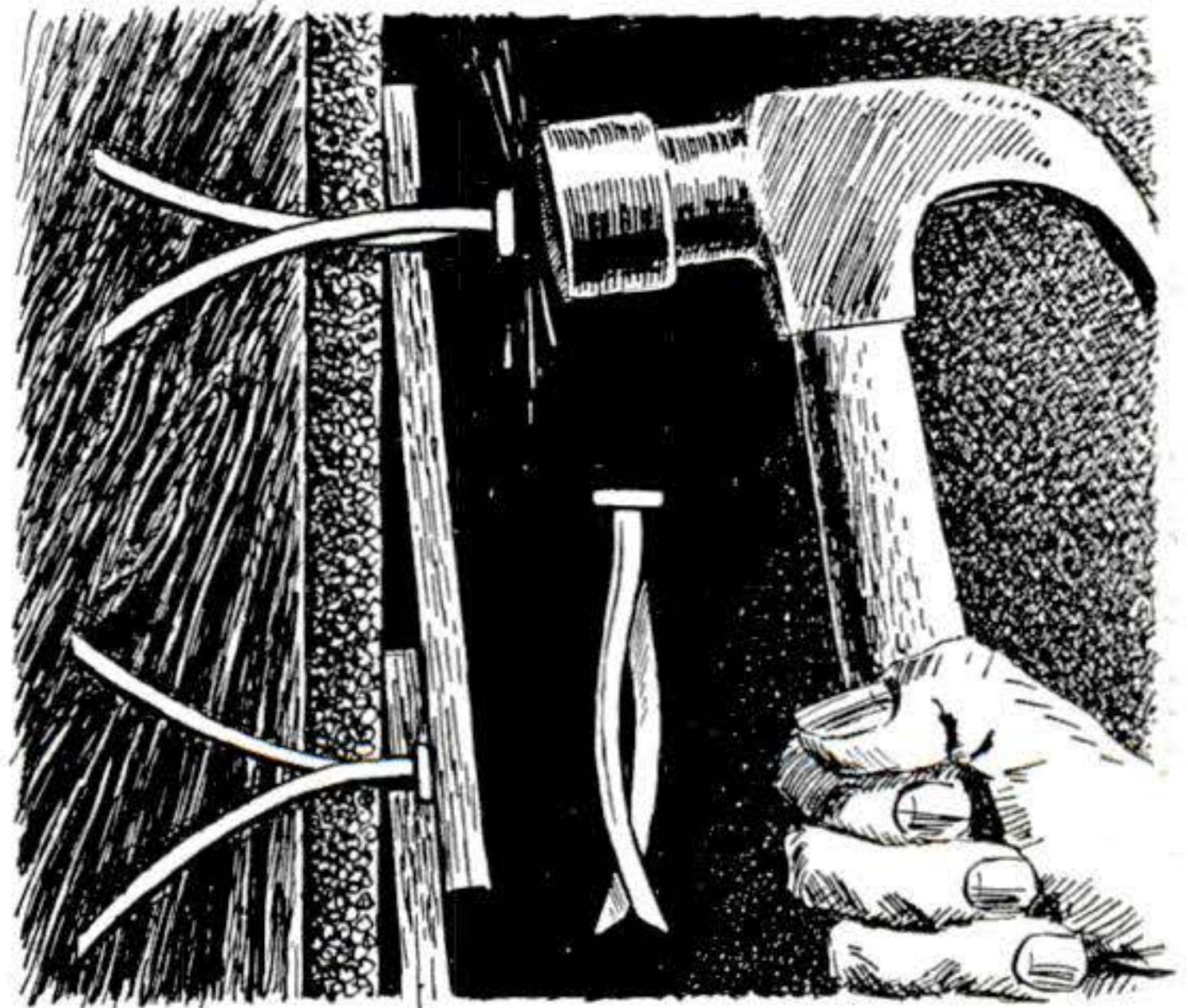

3 Nail to Lock Itself in. Once you put this nail in, it would be in to stay. As you drove it, the slightly curved twin points would spread farther and farther apart, locking the nail tightly in place. The nail is designed especially for outdoor use, such as in shingles and siding that frost and wind frequently pull loose.

Please turn the page for three more new ideas.

JANUARY 1952 113

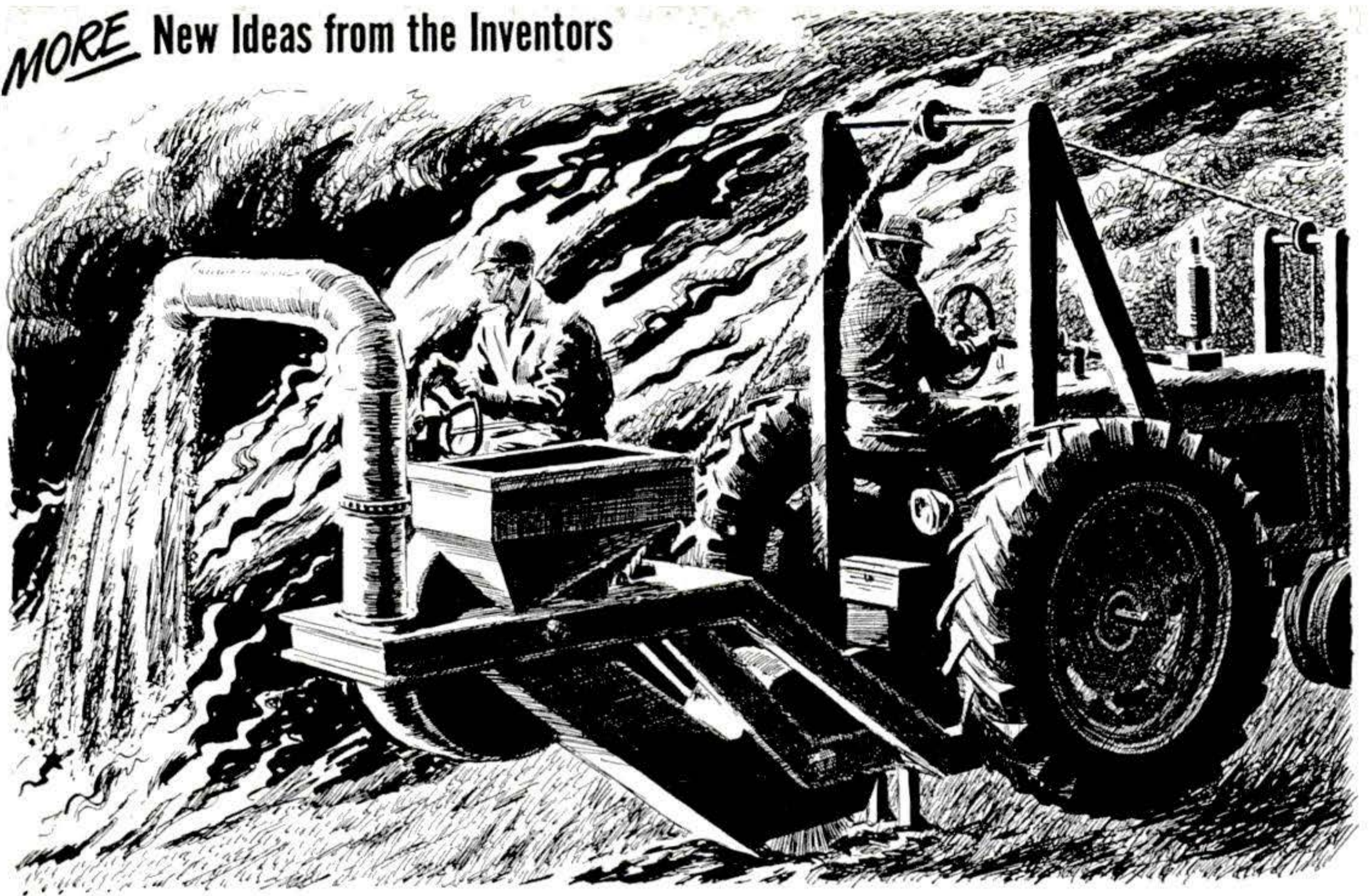

4 Dirt Blower to Smother Fires. When you're fighting fires out in fields and forests, you're likely to have few water hydrants around—but plenty of dirt. This fire fighter would make use of the dirt. Towed

by a tractor, the machine would pick up earth on one side with a plowlike scoop, then feed it into a hopper. On the other side a gasoline-driven blower would spray the dirt out of a hose to smother the flames.

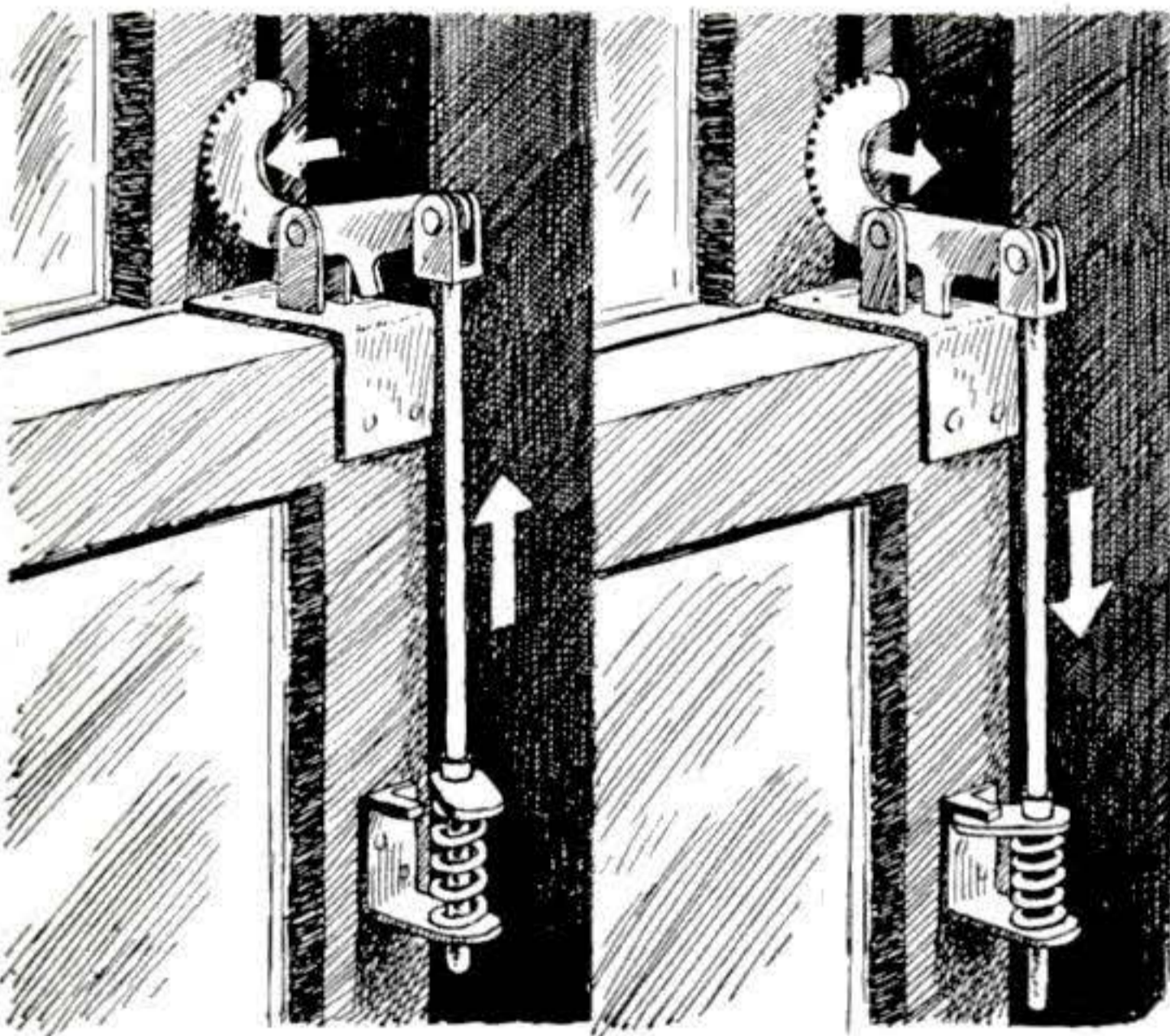

5 Window to Lock Automatically. This window would lock itself if you forgot. A toothed cam, mounted on the lower sash and bearing against the upper one, would let both sashes close, but then keep them from opening by wedging itself between the two frames and jamming them. Pulling back the spring-loaded cam would free them.

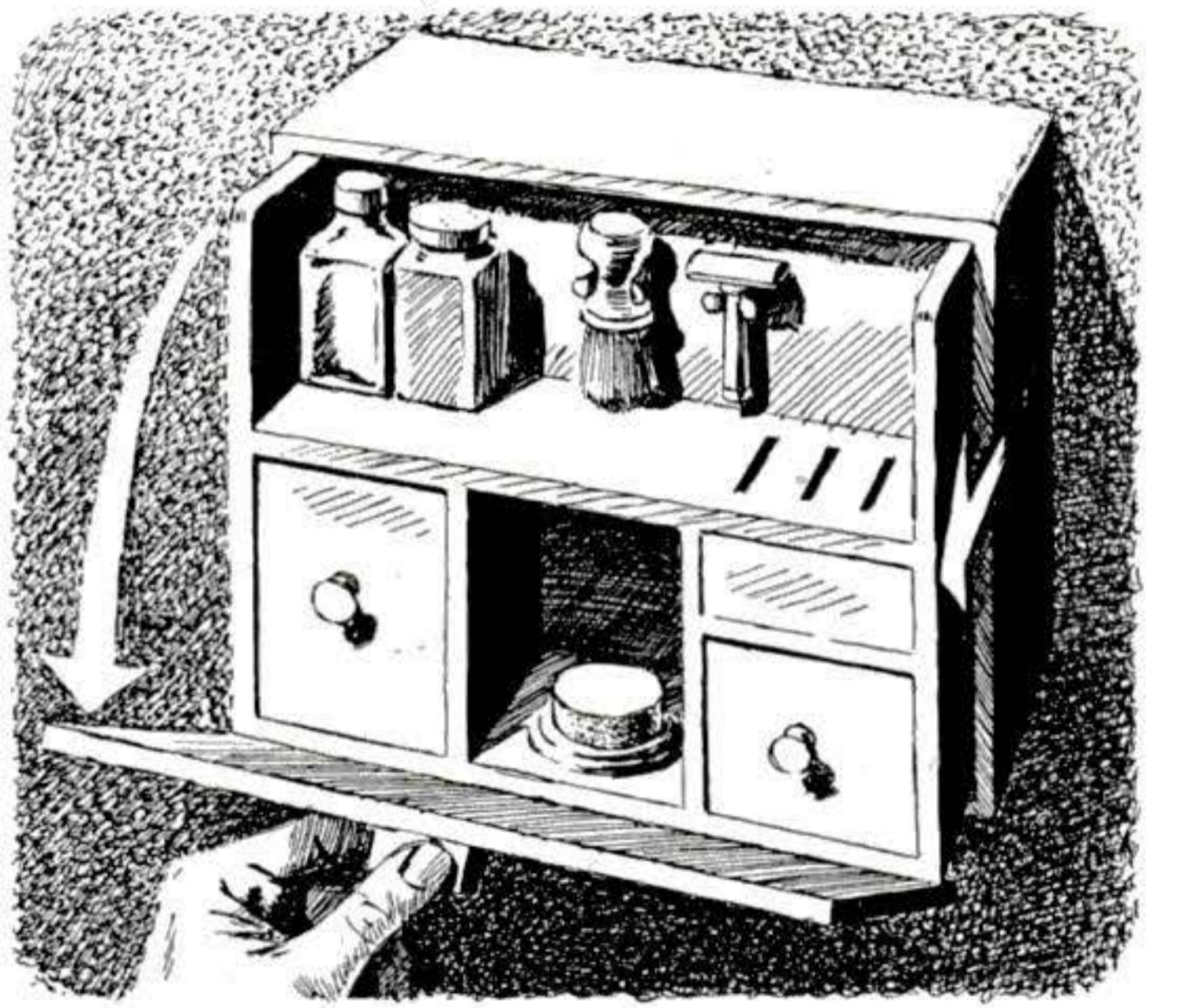

6 Wall Cabinet to Pull Out. Shaving gear and other bathroom needs would pull right out where they are easy to get at with this wall cabinet. The inside, mounted on tracks, would slide out when the door was pulled open. In its opened position, the door would also serve as a handy shelf for holding the articles in use.

Patents on these inventions have been granted to: 1. R. Bill, San Leandro, Calif.; 2. J. Doolan, Edmonton, Alberta, Canada; 3. R. Hallock, Larchmont, N. Y.; 4. J. Hurlbert, Dishman, Wash.; 5. P. Foley, New York, N. Y.; 6. G. Wise, Washington, D. C.

Electronics Weighs Gigantic Machinery

WHILE a giant transformer dangles from a mighty crane, a dial on a little wagon (right) tells its weight at a glance—98 tons. Electric strain gauges in the massive crane hooks are wired to the cart, devised by GE engineers to measure weights beyond the capacity of ordinary scales.



Spray Renews Golf Balls

FOR a gleaming new white coat, just grip a golf ball in the special holder and spray it with this finish. The maker is Federal International Co., New York.

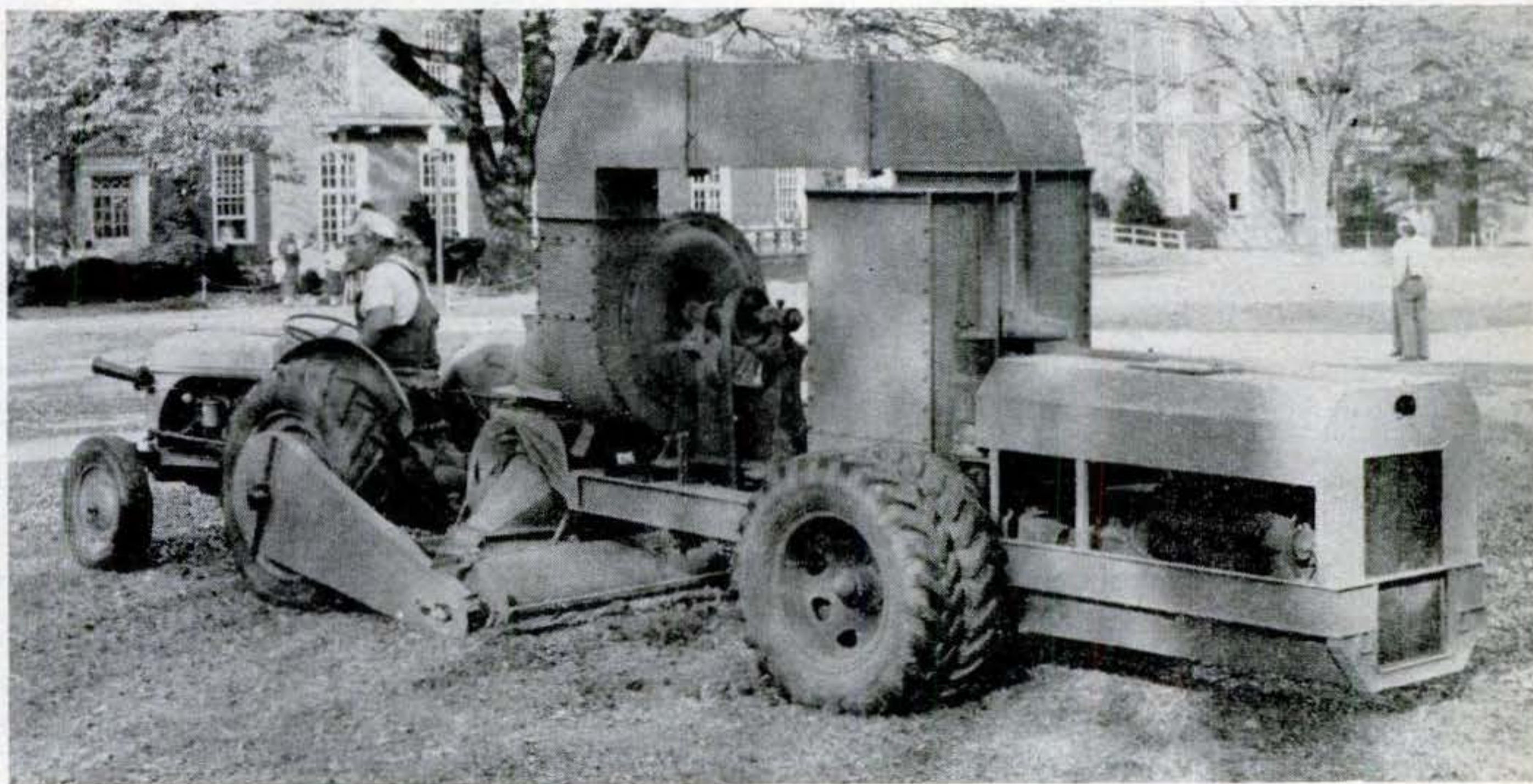
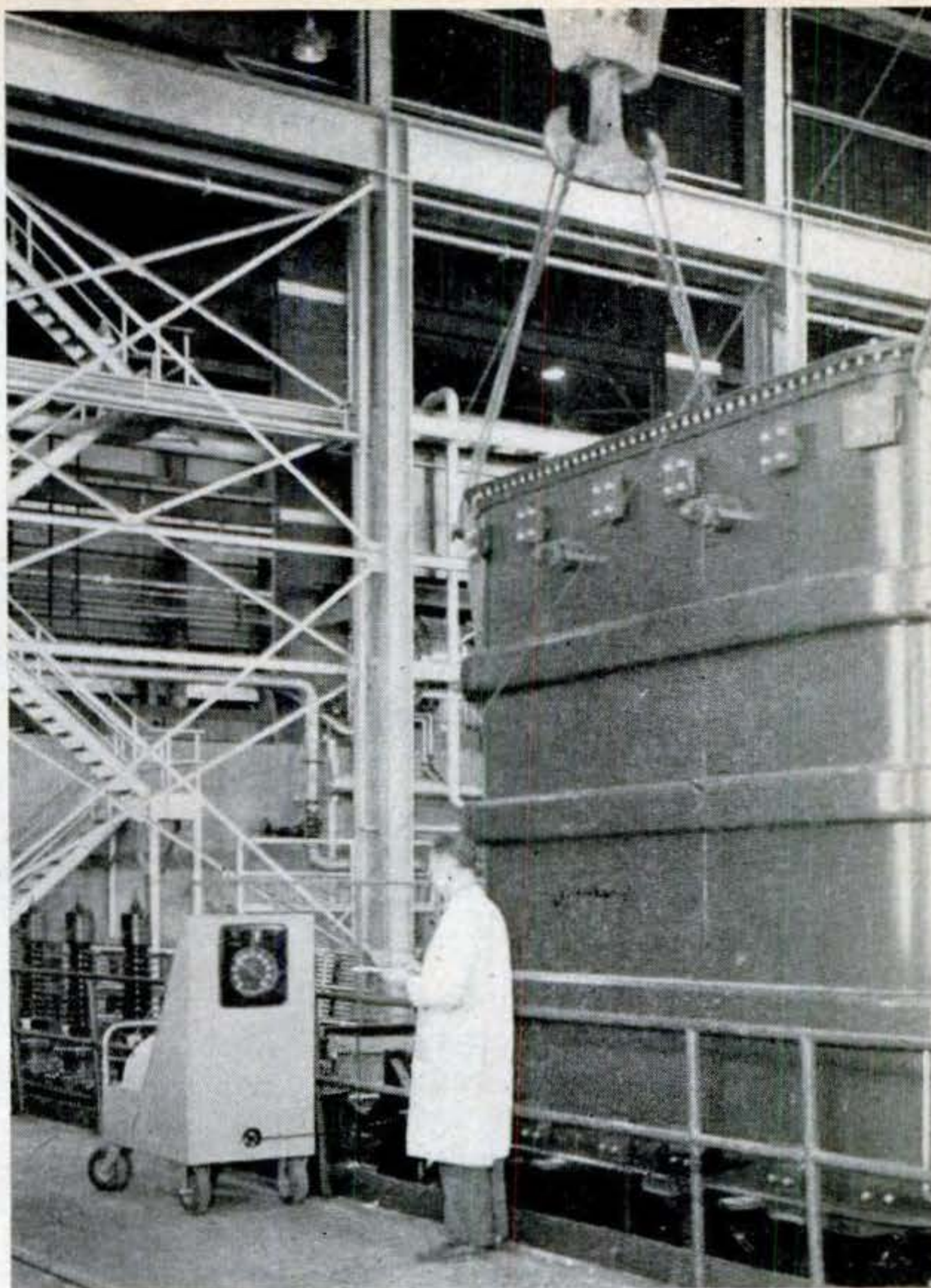

Machine Vacuums Leaves Off Lawn, Chews Them into Fertilizer

RAKING up the leaves of 4,000 trees on the 450-acre University of Illinois campus used to be a six-week job for a dozen men. Now the raking and the bonfires are ended. The tractor-drawn vehicle above, success-

fully tried out last fall, chews up the leaves instead. A vacuum nozzle picks them up, a hammer mill pulverizes them and a fan blows the valuable, soil-enriching particles back over the ground.

Your first ride in America's New Light Car

Both economical and lush, the Willys can give you 35 miles on a gallon—and give it to you comfortably.

**By Wilbur Shaw
and Devon Francis**

EVER since the war, lean, energetic Ward Canaday, head of Willys-Overland, has dreamed of putting out a light car that would seat six people. Last month he did it. He announced a light automobile that rides like a Cadillac or a Lincoln and gets up to 35 miles on a gallon of gas.

Canaday did even better. He powered his vehicle with a 90-hp. engine having a compression ratio of 7.6:1—second highest in the industry for standard-size cars—and made it run on ordinary, non-premium fuel.

What the design amounts to is a brand-new class of U.S. automobile. Despite a wheelbase of only 108 inches, it does seat six passengers of average displacement comfortably. Front and rear seats are exactly the same width—a roomy 61 inches.

The new Willys has more horsepower per pound of car than anything else in its price class. Its six-cylinder engine develops more horsepower per cubic inch of piston displacement than that of any other U.S. car, regardless of price. At 50 miles an hour in overdrive, it will run for 500 highway miles on one filling of its 18-gallon tank.

It is hundreds of pounds heavier than the other two light American cars, the Nash



...more horsepower per pound of car...



From an indicated speed of 60 the car came to a full stop in 156 feet



The "Aero" trod washboard as though it were glass-smooth

Front and rear seats are exactly the same width—61 inches



We accelerated to 60 miles an hour in 20½ seconds

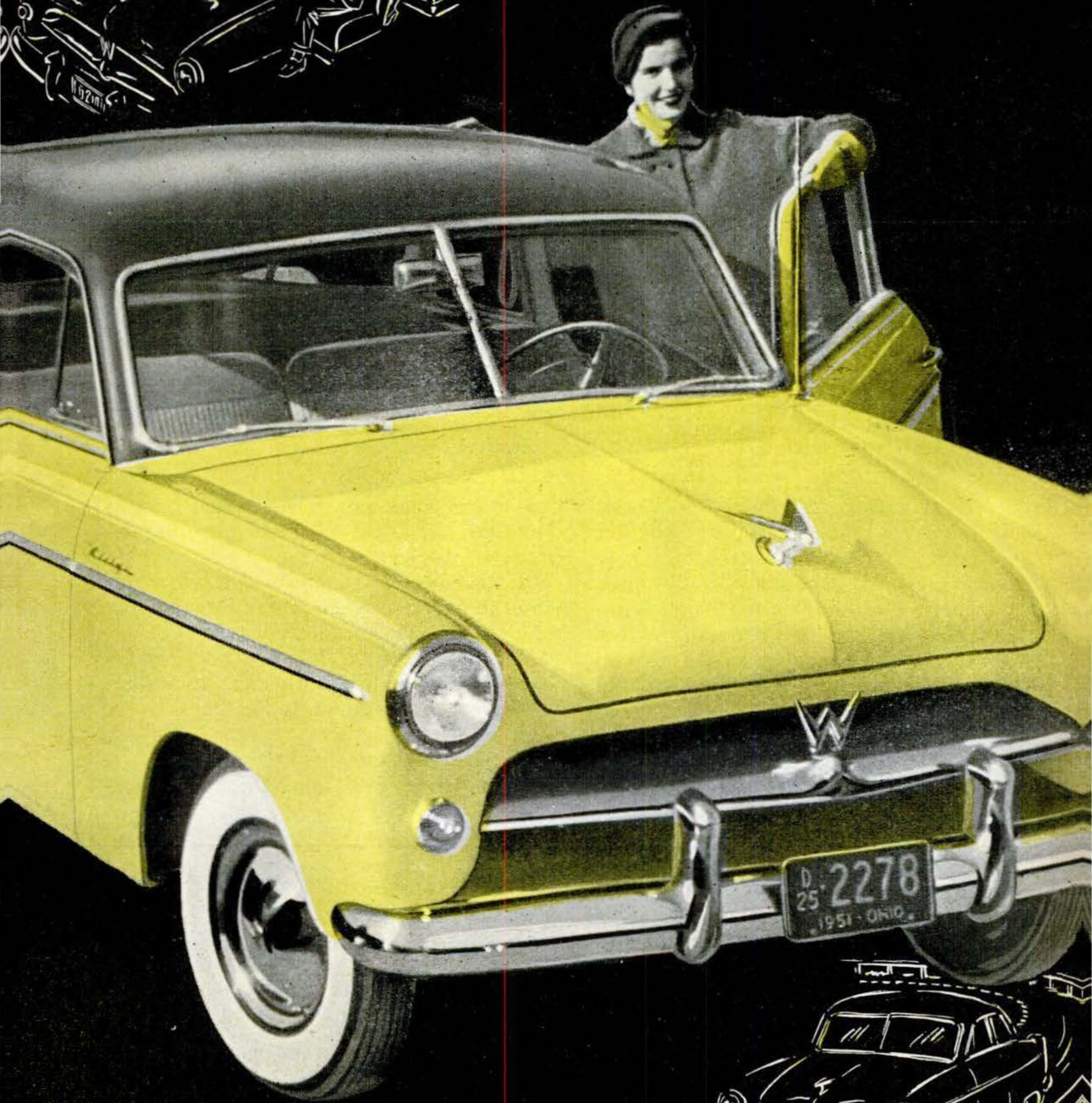

It took right-angle flat turns at 45 miles an hour without evident sway



... 500 highway miles on one filling of its 18-gallon tank



AERO ACE MODEL took turns on Speedway at full throttle without evidence of sway. Shaw felt that big single-sheet rear fender might prove expensive to repair.



HERE'S A SURPRISE! Both rear fenders can be seen from driver's seat. On production models gas cap is next to license plate for easy access from either side.

Rambler convertible and the Kaiser-Frazer Henry J, but it is hundreds of pounds lighter than a Ford, Chevrolet or Plymouth.

It's not cheap. It costs considerably more than a Henry J and a bit more than a Rambler, Ford, Chevrolet or Plymouth. Willys' "Aero" car, as they decided to call it, is in the company's own words, a "light, quality automobile."

It was not until we drove this car on the Indianapolis Motor Speedway that we began to appreciate what the man Canaday,

then board chairman, meant when he laid down the law to the Willys engineering department two years ago:

"I haven't the slightest idea what it's going to look like when you're through," he said, "but here's what it's got to do."

He ticked off on his fingers what he wanted—economy, performance, quietness, an exceptional ride and, finally, ease of handling.

He wasn't disappointed.

The car has scat. Going through all for-

FACTS ON WILLYS LIGHT CAR

Make and model: Willys Aero Ace series 685 two-door sedan.

Engine: 6-cyl. F-head; 90 hp. at 4,400 r.p.m., car weight per hp., 28.4 lb. (dry); bore and stroke, 3 $\frac{1}{8}$ " by 3 $\frac{1}{2}$ "; compression ratio, 7.6:1; piston displacement, 161 cu. in.

Engine piston travel: (in feet per car mile at 20 m.p.h.) 1,889 standard, 1,471 with overdrive.

Crankshaft bearing surface: 34.14 sq. in.

Torque: 135 lb.-ft. at 2,000 r.p.m.

Transmission: 3-speed sliding gear, synchromesh second and third gears.

Rear-axle ratio: 4.1:1 standard, 4.56:1 with overdrive.

Steering ratio: 19.7:1.

Radius of turning circle: 19'.

Effective brake-lining area: 133 sq. in.

Springs: front, coil; rear, semi-elliptic.

Weight and outside dimensions: 2,562 lb.; height (full load) 60"; over-all length with bumpers and guards, 180 $\frac{1}{2}$ "; width, 72"; wheelbase, 108"; overhang, front 32", rear 40 $\frac{1}{2}$ "; tread, front 58", rear 57".

Inside dimensions: seat-cushion width, front 61", rear 61"; leg room, front 42 $\frac{1}{2}$ ", rear 36 $\frac{1}{4}$ "; headroom, front 35 $\frac{1}{2}$ ", rear 34 $\frac{1}{2}$ "; seat height, front 12 $\frac{3}{4}$ ", rear 11 $\frac{1}{4}$ "; vertical distance, steering wheel to seat cushion with seat in mid-position, 5 $\frac{1}{2}$ "; front-seat adjustment, horizontal 4", vertical none.

Tire size: 5.90 by 15; optional, 6.40 by 15.



LOW, DOWN-CURVING HOOD increases vision, Shaw finds. Both models have two-piece curved windshield. Front seat is split and hinged. Dash lights tell when battery is dis-

charging or oil pressure is low. Turn indicators are standard on custom line, optional on others. All cars come undercoated. Trunk lid is hinged outside to increase space.

ward gears, we accelerated to 60 miles an hour in 20½ seconds. The Willys engineering department had posted a figure of 17½ seconds to 60 and held doggedly to it despite our report from the driver's seat. We're inclined to split the difference with a tuned engine. The car we drove hadn't been touched after a long, hard road test.

It was the engine that got us. Last year Willys brought out its four-cylinder F-head engine, which has a big overhead intake valve and an exhaust valve in an ante-chamber like an L-head's (PS, Nov. '50, p. 152). The F-head is now adapted to the new six, and the results are little short of sensational.

Outdoes Even Maker's Claims

The car walked right on past 60 to 70, then 80 and pegged its speed at 86 in direct drive. The engineering department had stated, with commendable conservatism, that 70 was tops without overdrive. But it wasn't the speed that impressed us most. It was the smoothness of the engine. Whatever vibration it had was effectively insulated from the body.

In overdrive the car did only a little better—89 m.p.h. It cruised beautifully at 75.

Even with ordinary gas, hard acceleration gave no knock. Coasting down to an in-

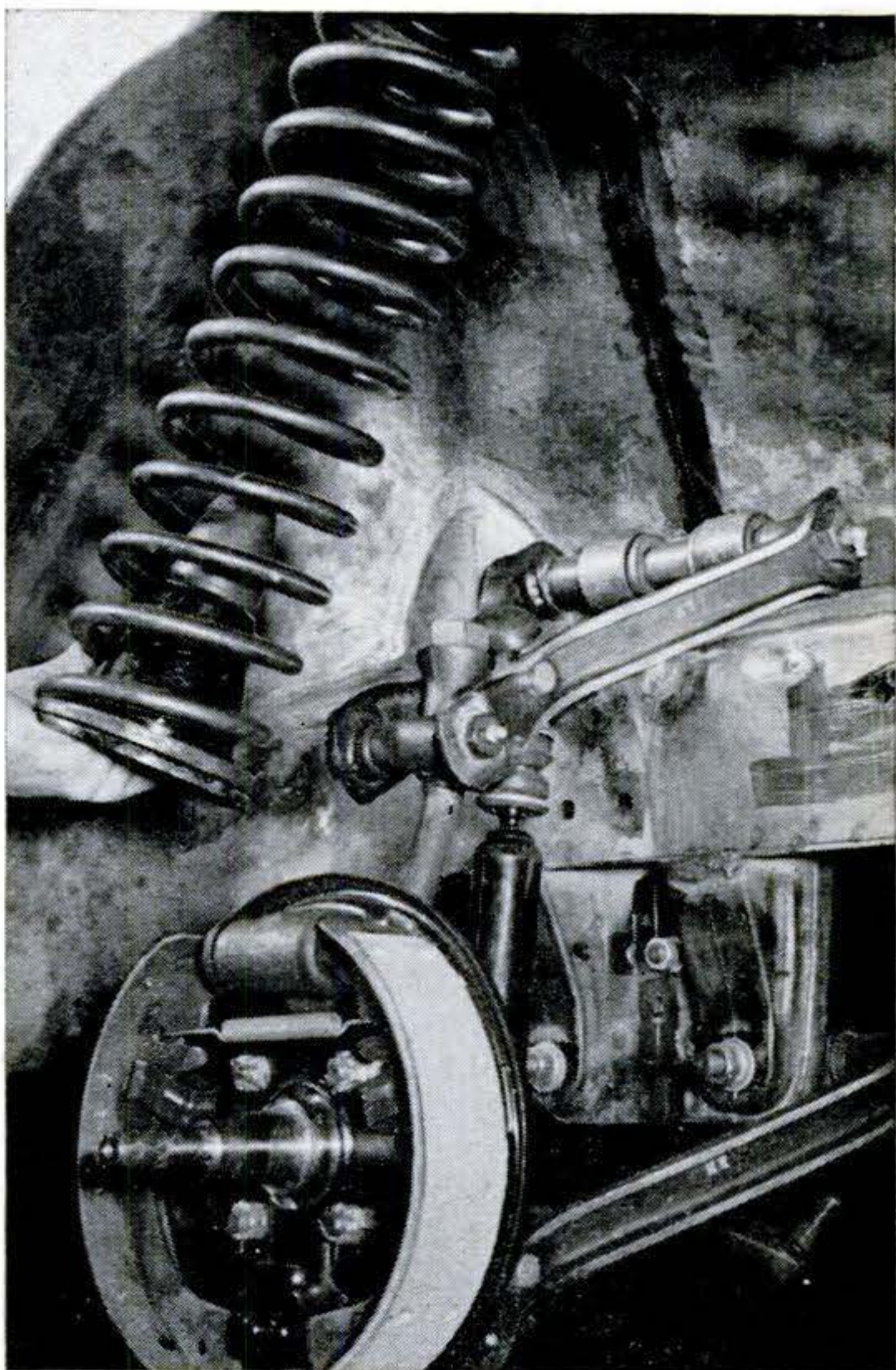

FRONT SUSPENSION and springing are essentially like Nash Rambler's (PS, May '51, p. 82). Wheel-support members attach directly to the body sheet metal.

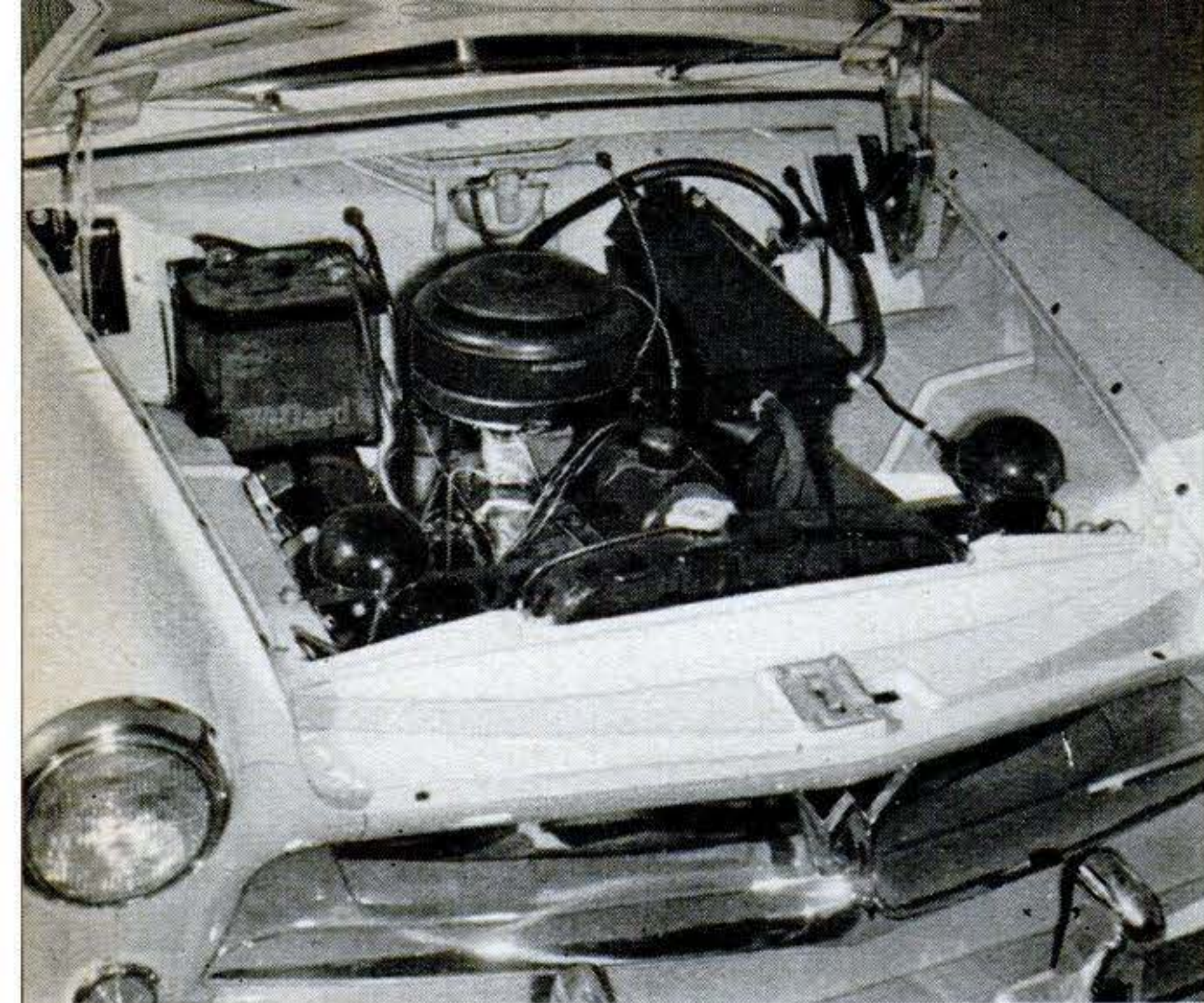

ENGINE has intake manifold cast integrally with block to eliminate gasket that might cause leakage. Cutaway (right) indicates position of single rocker arm for each cylinder, and extra-big intake valve.

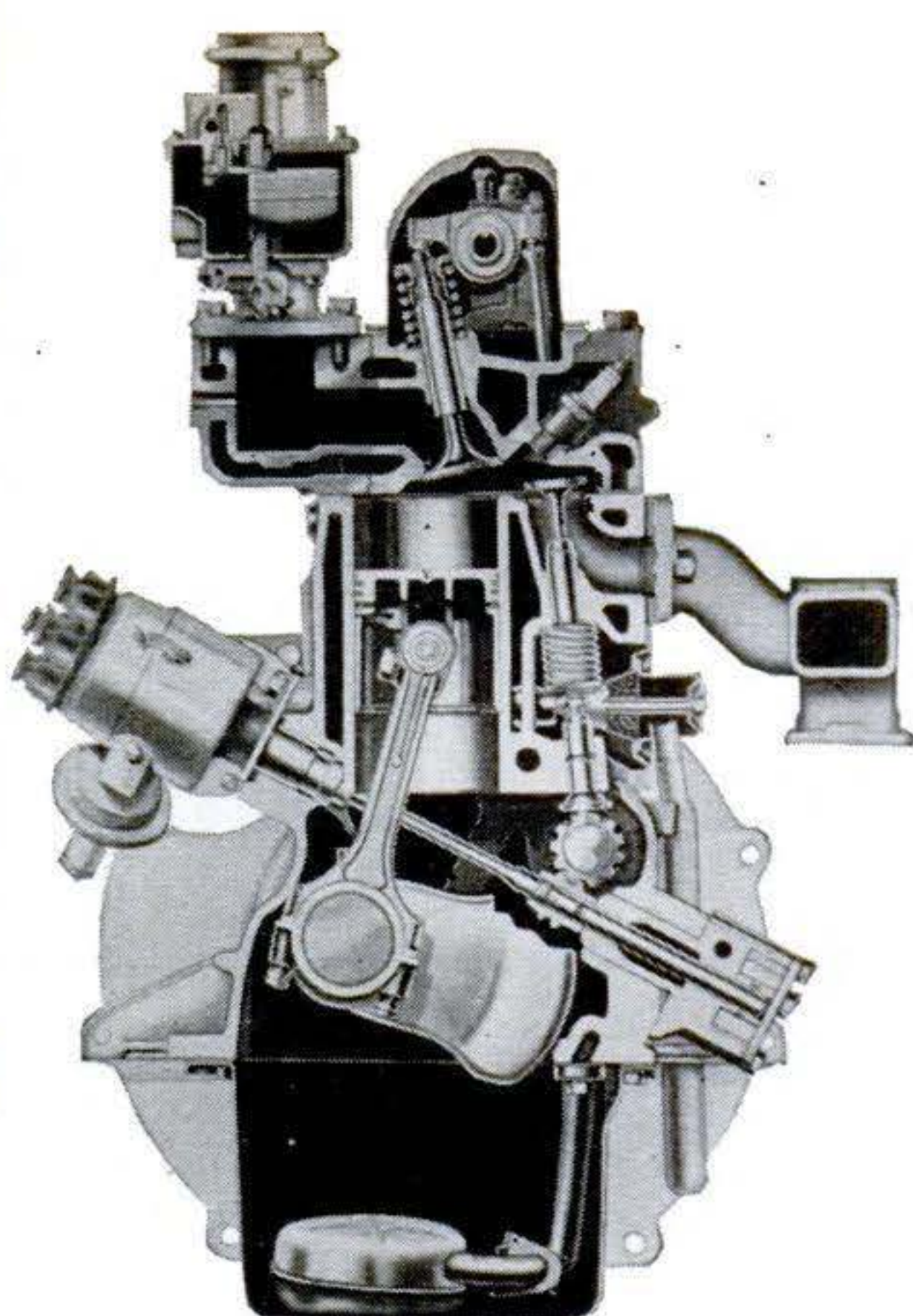

indicated 10 miles an hour, we put the accelerator on the floorboard. If a "ping" developed, we would have to hear it—the engine operation was that quiet. Two things promptly didn't happen. No jerk occurred as the engine surged. And there was no ping. Just to be sure, we tried it twice more. Still no ping.

Engine Won't Vibrate

The absence of jerking under sudden full throttle was something else again. Here was a car with a direct mechanical connection between the engine and the rear wheels. It seemed to us that there was bound to be some lash in the power train.

Yet both the engine and the power trans-

mission displayed excellent smoothness. Here is why:

The basic vibration frequency of the entire power plant—the one you would get if you could hit the engine like a tuning fork—is below the vibration frequency generated by crankshaft and piston at idling speed. The engine will stall before it vibrates enough to set up any oscillation in its mounts. As engine speed increases, the disparity between generated vibration frequency and the basic frequency of the engine becomes even greater.

As for cushioning the drive, that would be easy if the car had a fluid coupling—the fluid is the cushion. But the Willys has none.

[Continued on page 240]

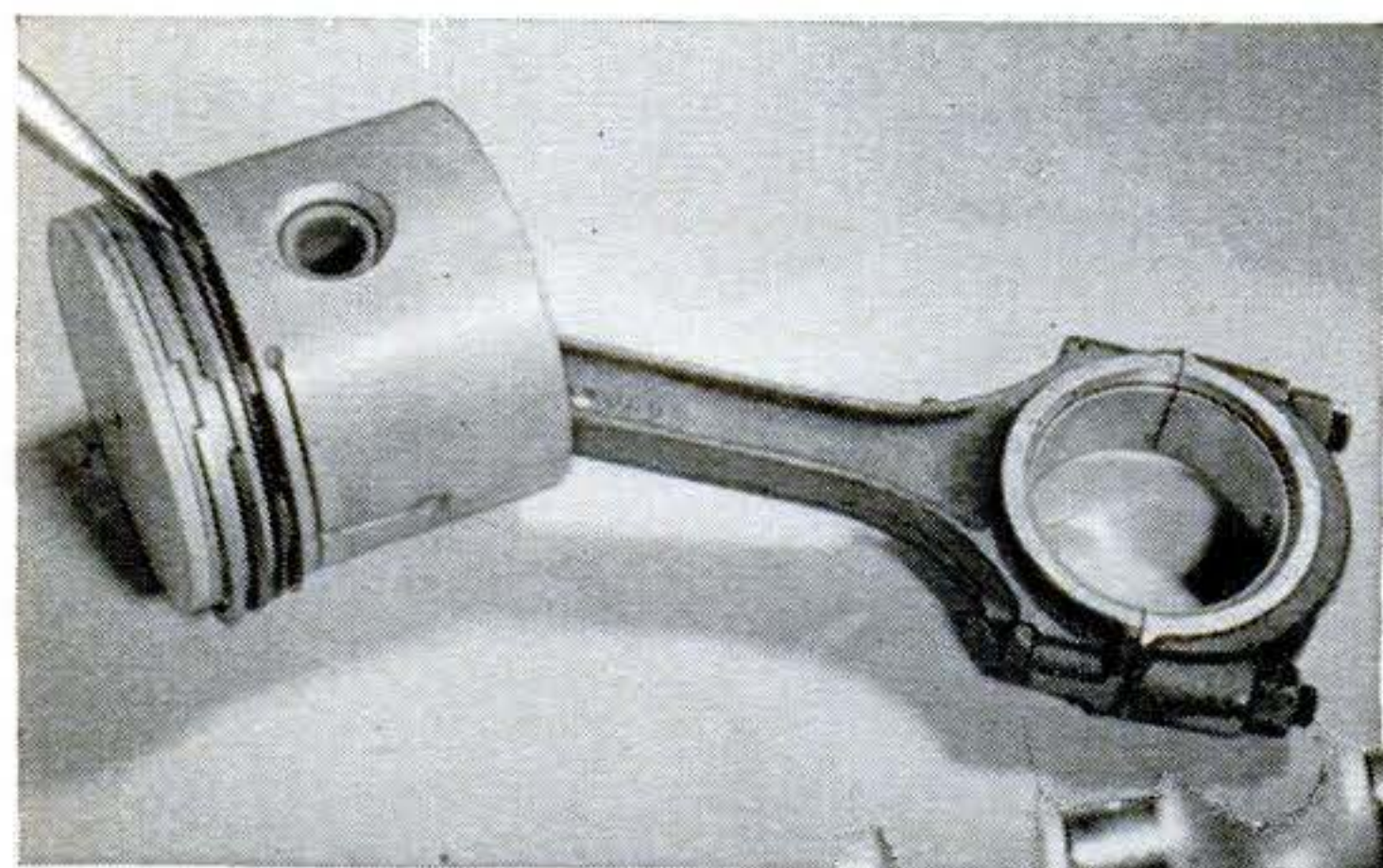

ALUMINUM PISTON (left) has one oil ring (indicated by pencil), two compression rings. Crankshaft (below) has four main bearings. Valves are self-rotating to discourage carbon.



Keeping the Home Shipshape



A LAMP FOR LIGHTING THE PLAYROOM FLOOR, or low tables and chairs, can be made from a discarded lamp cut down to four feet. Add a diffusing bowl, if lamp has none.



WHEN PAINTING WALLS, you can protect baseboards by applying masking tape to the tops of the boards and pressing it down flat over newspapers.



AN EMPTY WINDOW-SPRAY BOTTLE, refilled with turpentine or kerosene, is useful in the shop. A few squirts will clean hands that are soiled with paint or grease.



A TOOTHBRUSH IS HANDY for scrubbing fork tines, beater blades, strainers, graters, can openers and other equipment with holes and crevices that a dishcloth won't reach.

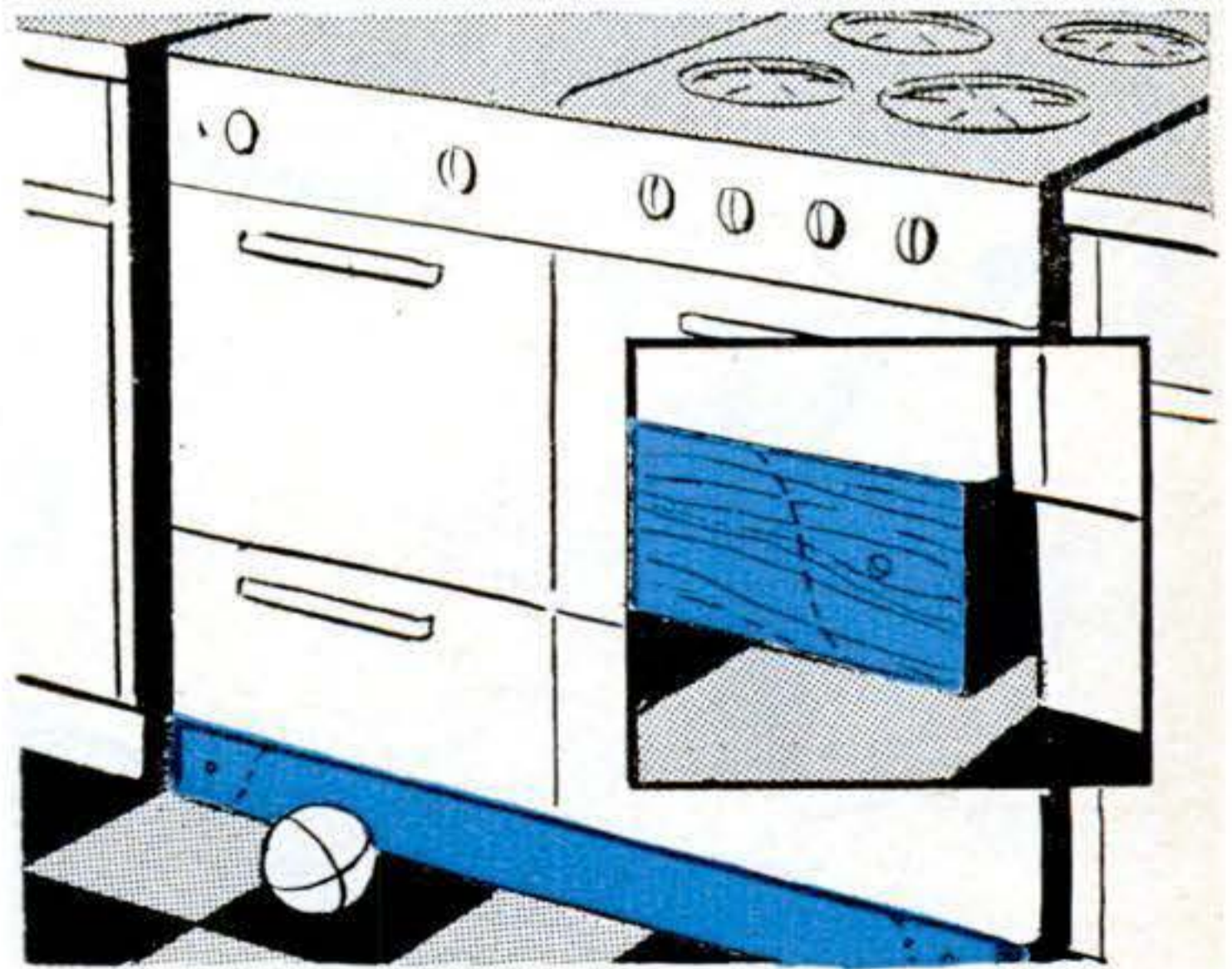

A BASEBOARD at the bottom of the stove will keep toys and utensils from rolling underneath. Drill a hole in each front leg and bolt a piece of plywood across.

Please turn the page for five more suggestions.

JANUARY 1952 | 21

Keeping the Home Shipshape

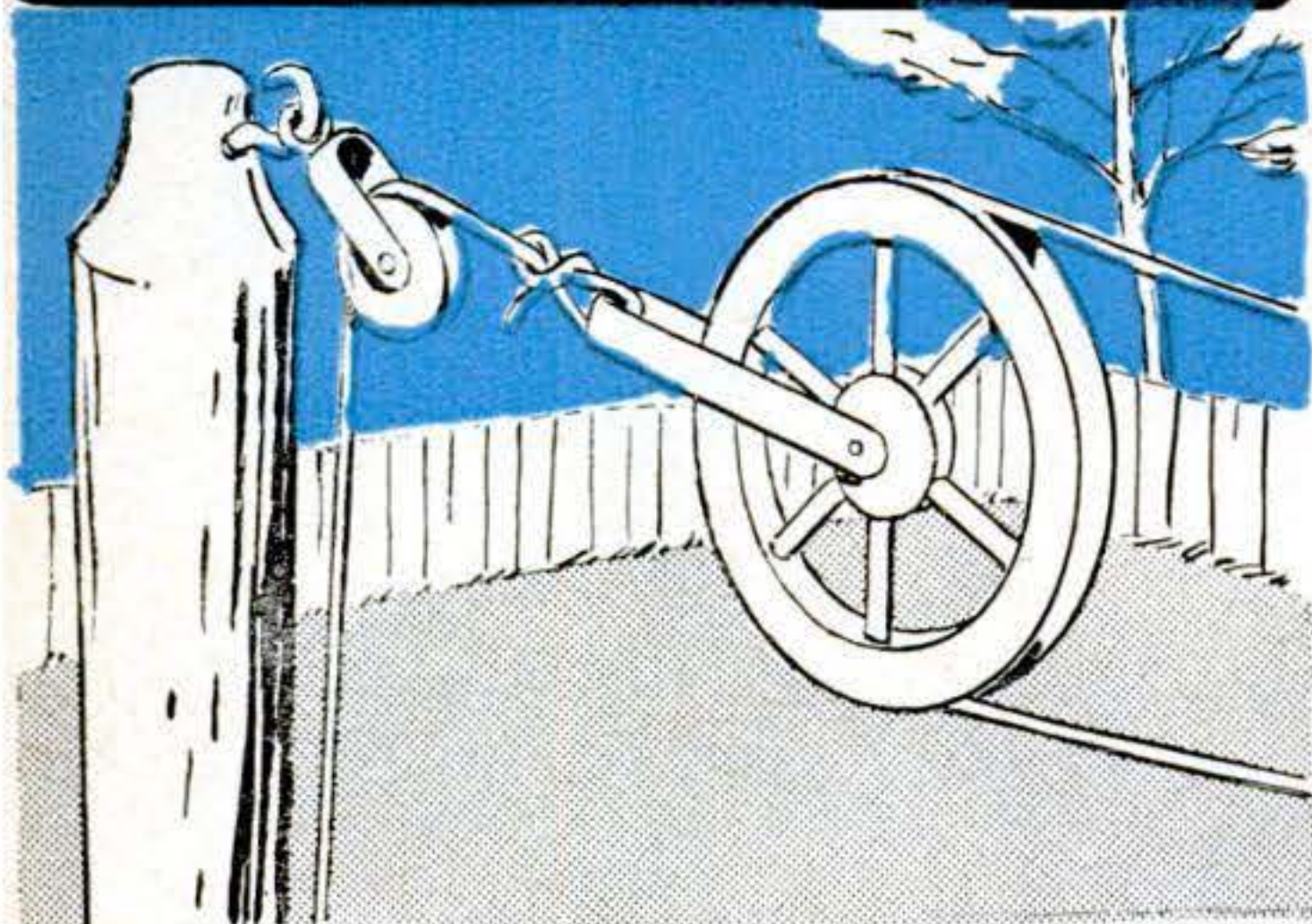

REPLACING A SECOND-STORY CLOTHESLINE is a tough job. Add a second pulley near the top of the pole and you can lower and raise the line pulley easily.

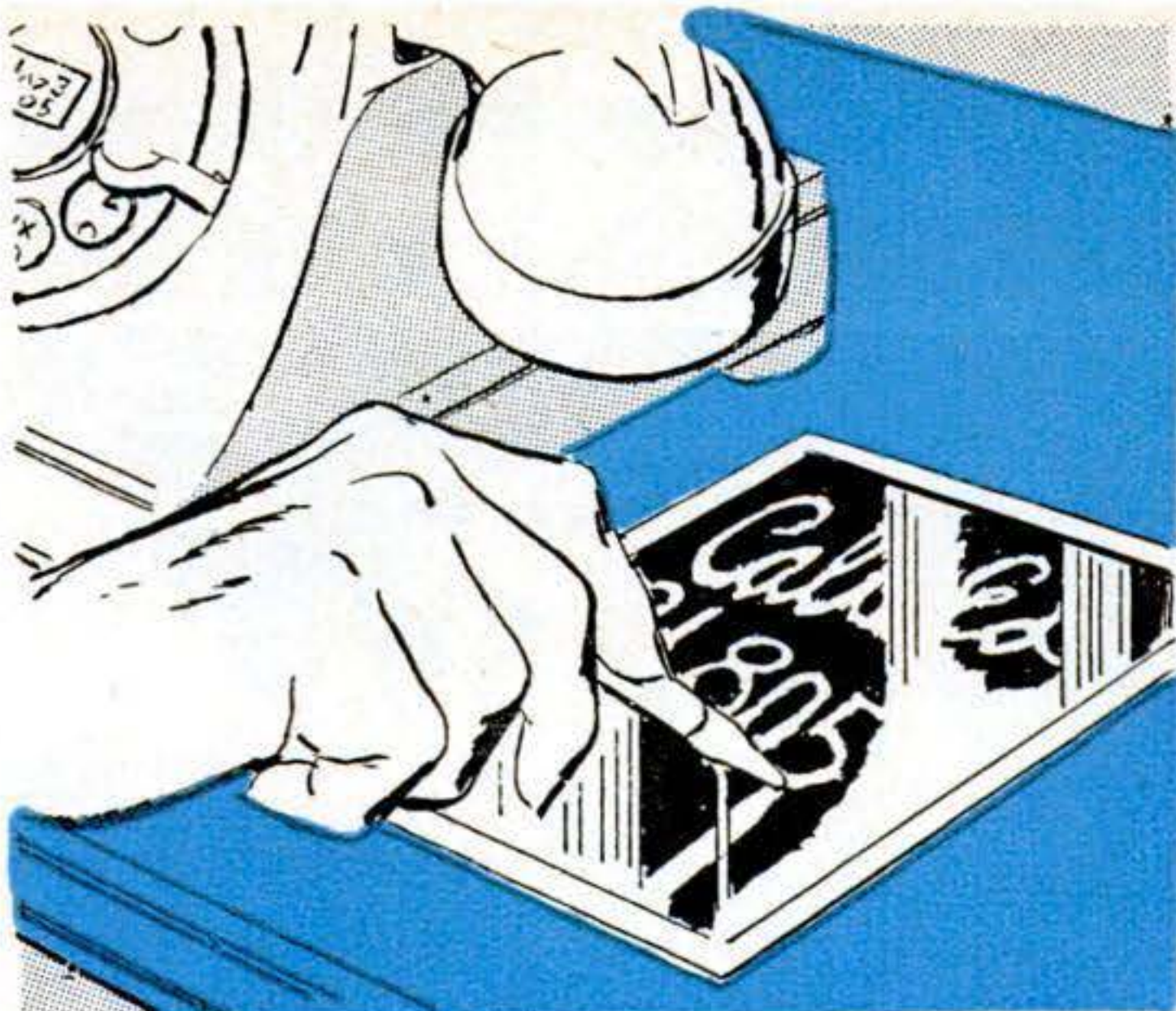

A POCKET MIRROR is an excellent memo pad for use near the telephone. Messages written on the mirror with a wax china-marking pencil can be wiped off with a wet cloth.



FABRICS WILL RAVEL LESS when cut for buttonholes if each place where an opening is to be cut is first marked with colorless nail polish. When polish dries, slits are cut.

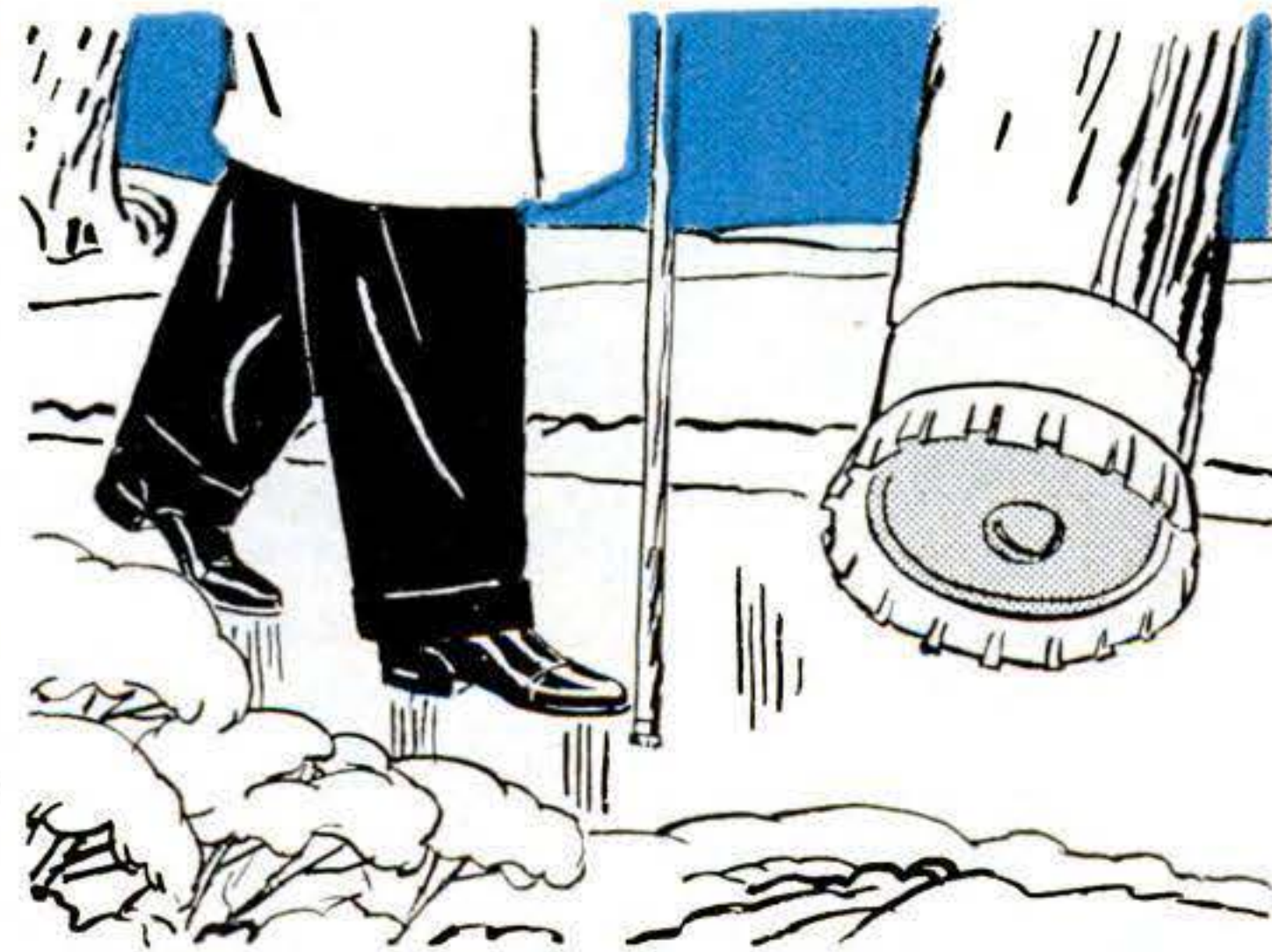

A CANE WON'T SLIP ON ICY SIDEWALKS if a pop-bottle cap is screwed to its tip. The cap can be covered with a rubber crutch tip when the cane is used indoors.



A LEFTOVER ROOFING strip, rough side up, makes a good slipproof mat for use in front

of laundry tubs or other wet places. It also acts as an insulator.

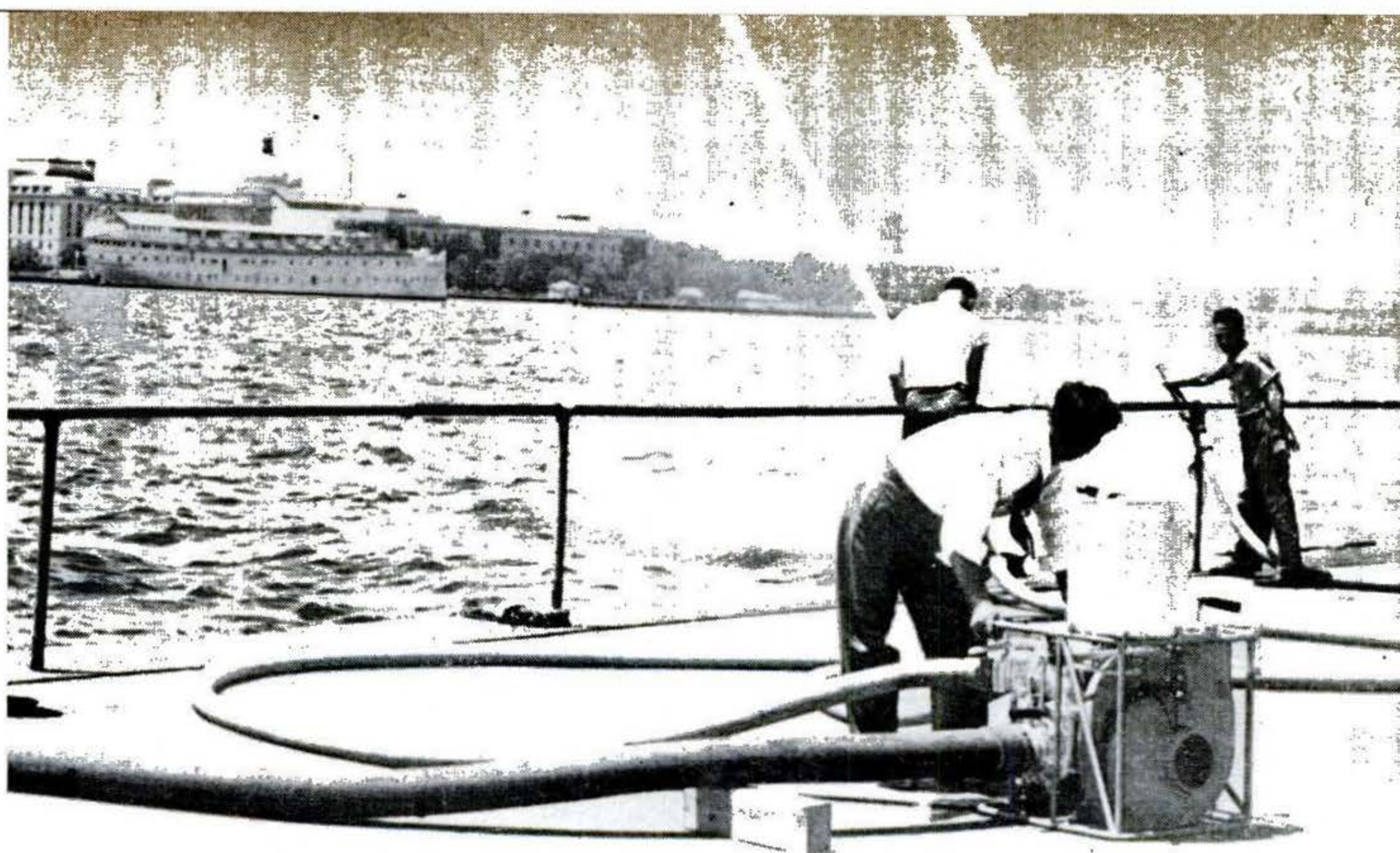

In trials, midget gas-turbine pump delivers 500 gallons of water a minute through two hoses.

Baby Gas Turbine Runs Pump

The smallest gas turbine ever built—you start it with a hand crank—is shown here driving a new fire-fighting pump aboard a Navy ship. The unit delivers 500 gallons a minute, yet is light enough for two men to carry, occupies two square feet, and weighs 165 pounds.

The midget turbines, which develop 45 horsepower and whirl at 40,000 r.p.m., will also be harnessed to airborne generator sets by the Air Force. Solar Aircraft Co., San Diego, Calif., is the designer.

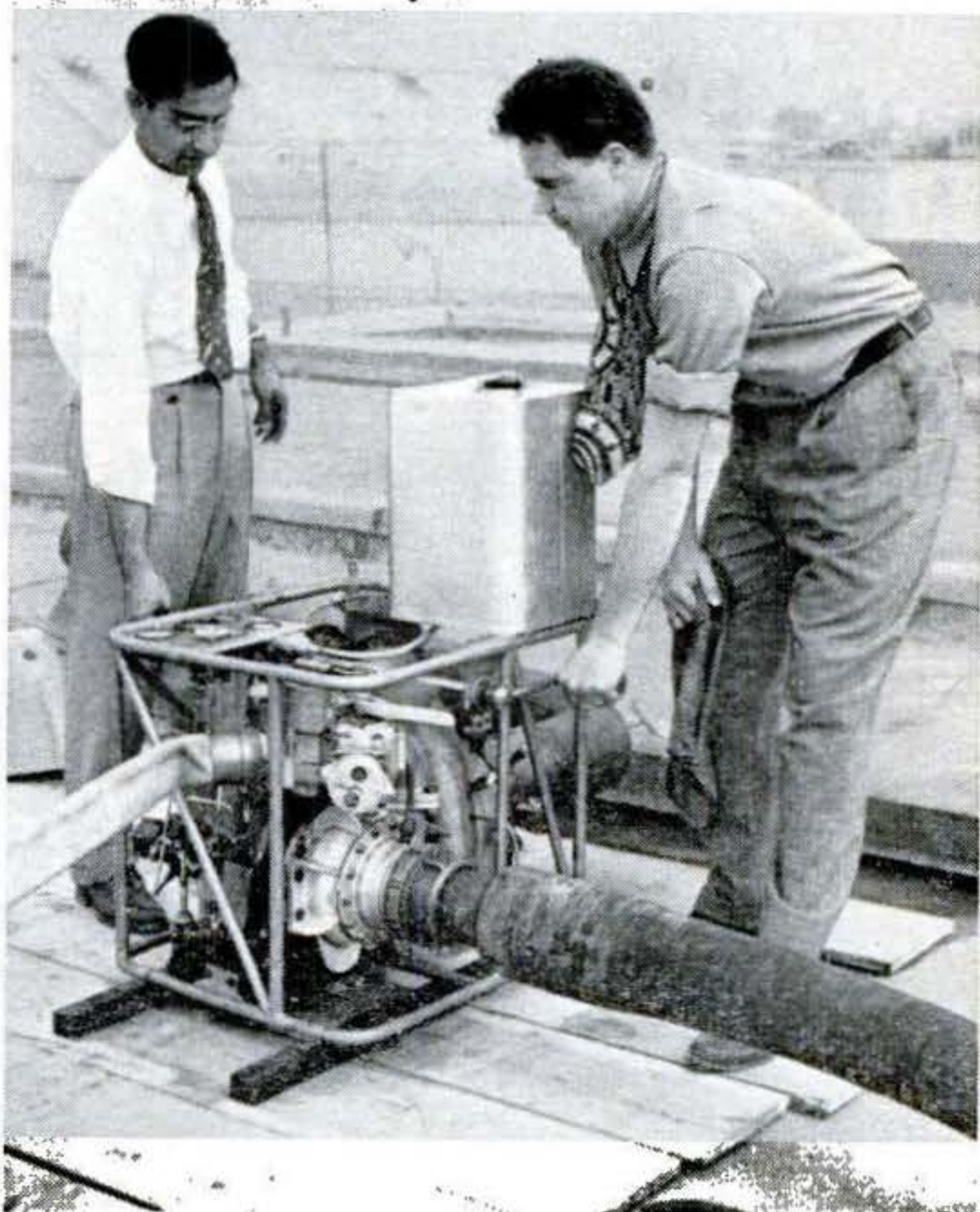

TWO HAND CRANKS spin turbine at 11,000 to 12,000 r.p.m. Then its own power takes over. It has two seven-gallon fuel tanks, one of which is shown installed above.

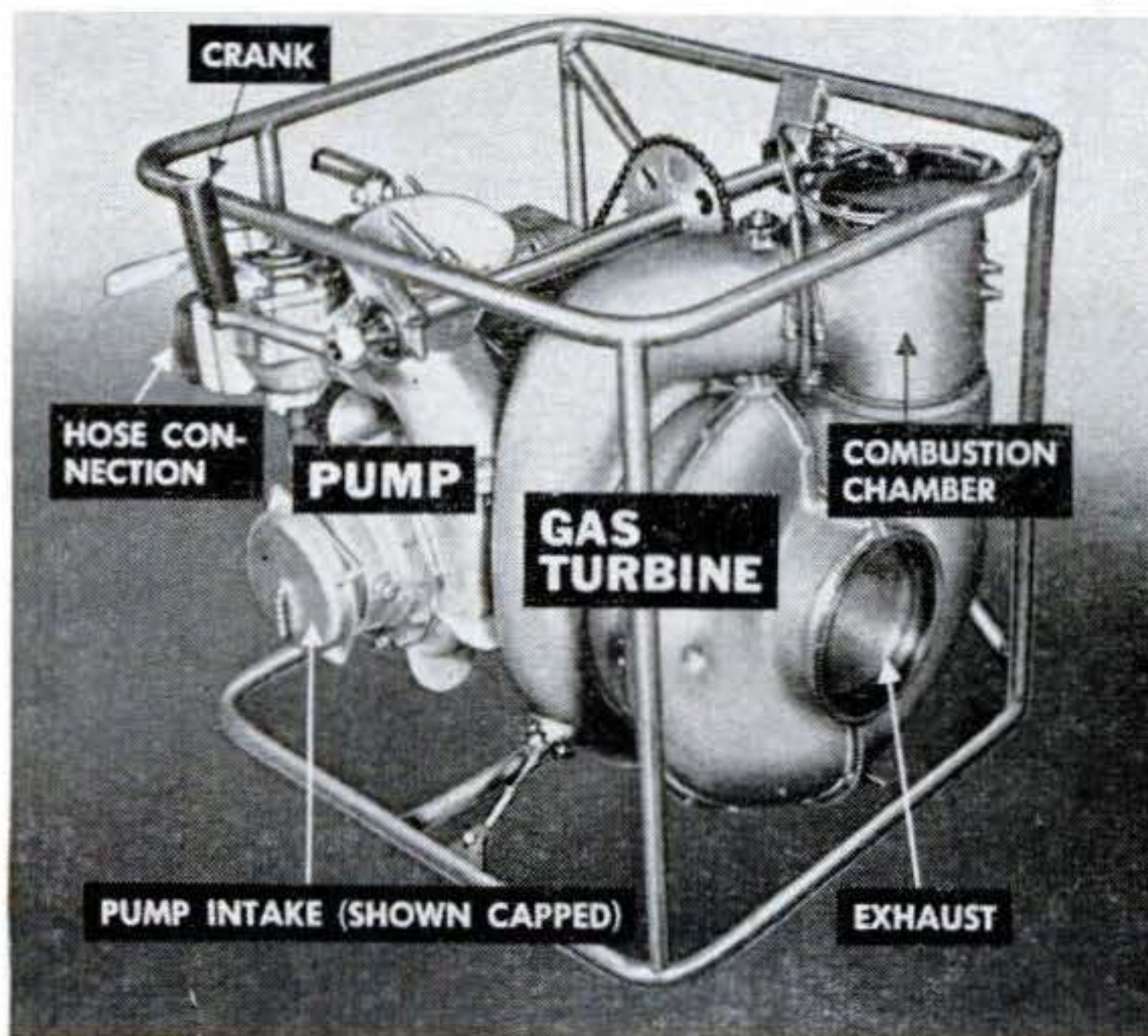

PICTORIAL DIAGRAM shows main parts. Crank handles spin turbine through chain-and-sprocket drive. Overrunning clutch stops turbine from driving cranks.

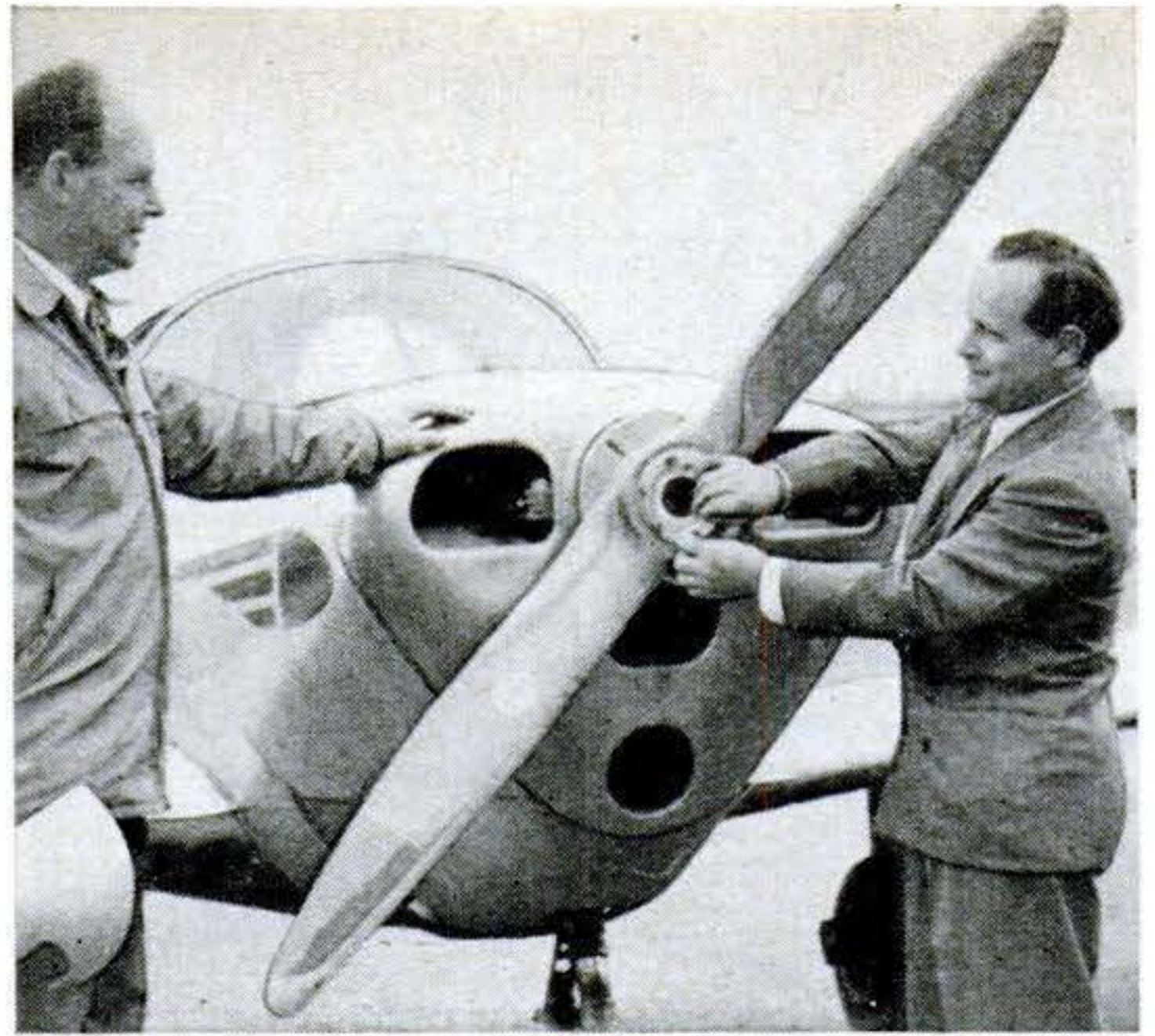
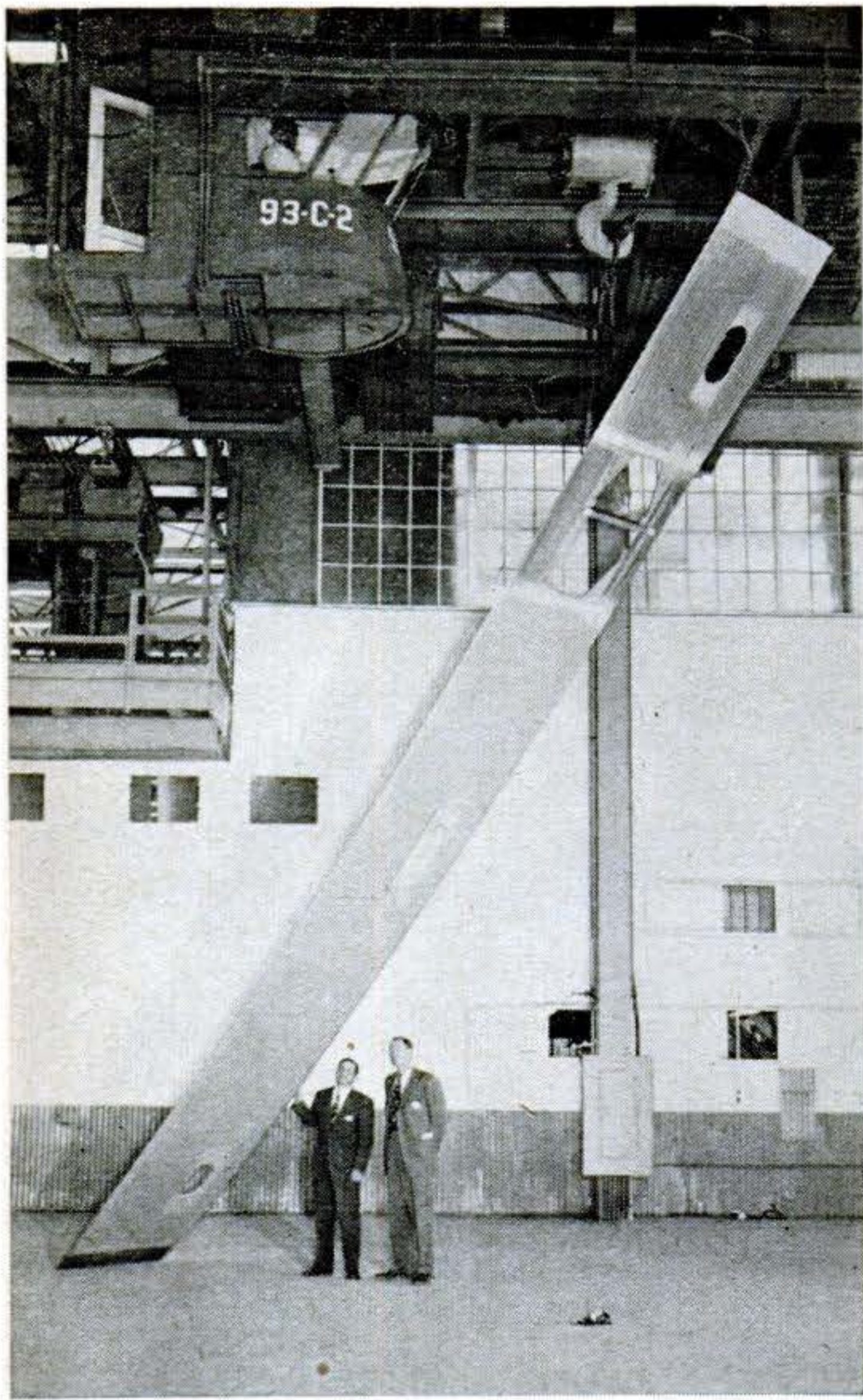

Propeller Adjusts Itself

THIS new wooden propeller automatically changes pitch as the plane climbs or cruises. Inserts with diagonal grain make the Flex-O-Prop twist the right way for a better bite under each load.

Big Pieces Make Plane Wing

LARGEST ever cut from a solid slab, a 32-foot aluminum wing section (left) for a Super Constellation saves the weight and labor of joining 1,500 parts with 5,000 rivets.

Car Trailer Has Two Stories

You can ride upstairs or downstairs in the two-story trailer below, recently exhibited at a motor show in London, England. The lower level has a living room (right) with a fireplace, bedrooms, kitchen and bathroom. A flight of stairs leads to a double bedroom on the upper level. Almost a real "house on wheels," the trailer can accommodate five passengers, or seven if the living room doubles as a bedroom.



How Jackpots Are Hit in Suggestion Boxes



Millions of dollars are being paid off by suggestion boxes. Take a tip from these winners and try your luck.

By Philip Gustafson

IF YOU have the knack for dreaming up new gadgets—plus a secret desire to get rich quick—it is about time you took a hard look at the suggestion business. Most progressive business or government organizations have suggestion systems these days, and the chances are yours does too. If your

idea clicks even faintly, it may bring you at least an “honorary” award of from five to 10 dollars. And if it’s hot—well, the sky’s the limit!

Charles Zamiska, of the Cleveland Graphite Bronze Co., shot at the moon. He worked out a better way of doing his own job—handling bronze castings. So far it has brought him in \$28,000, and it’s still paying dividends.

Johnson & Johnson, the surgical supply house, handed out \$10,440 to Harry Kenny and Milton Combs for suggesting a method

'Dear Boss: Drop Dead'

THE rejects from some of the suggestion systems would make a good comic book. They range from friendly—and sometimes not so friendly—samples of the employees' wit to flights of imagination that would make a Rube Goldberg invention look like a primitive lever and fulcrum.

One caustic comment demands: "Make the company calendar smaller. Think I live in a barn?"

A wistful suggestion from another employee was dreamed up to eliminate tardiness: "Last man in blows the whistle."

Few suggestion boxes escape the character who takes his pen in hand to louse up a good suggestion blank with that highly original witticism: "Drop dead."

of saving material in the cutting of gauze pads. Swift & Co. paid Harold Deering and Cliff Fredericks of St. Louis \$8,750 for developing a method of producing and marketing a new pre-packaged loin steak. Bausch & Lomb recently presented two profiling-machine operators, Charles McGill and Neil Bernard, with \$5,230 for simply proposing that plastic stock be cut into narrower strips in the making of eyeglasses frames. Mrs. Nina Vincent, a grandmother working at

Johnson & Johnson, won \$2,600 for tipping the company off that plaster of Paris could be wrapped in one long piece of paper instead of two short ones.

Thirty-two-year-old Ken Keich had tossed a lot of ideas into American Cyanamid's suggestion box and collected on nine of them—a \$10 check each time, enough for dinner and a night out with his wife and a sitter for their two-year-old. But when he was called in to pick up his tenth check, someone whispered, "You've just won \$3,380." His hand shook so violently that he couldn't open the envelope, and the man next in line had to do it. What was Ken Keich's \$3,380 winner? He told the company to keep a steam valve turned off for 30 minutes during one of its processes.

Health Dept. Employees Win Award

You need not pull a rabbit out of a hat to win a merit award—just leave him right in his cage. Dorothy Hoy and Mary Stang won a \$100 award at the New York State Health Department Laboratory in Albany for devising a portable stanchion that can be easily attached to the door of a rabbit cage—to hold the struggling animals firmly while they are inoculated for the production of whooping-cough serum. This new gadget saves lugging a struggling 10-pound animal to a table and wrestling it into submission.

Hobbies often produce money-making contraptions. John Polk, a home-workshop enthusiast and chemist for the New York State Division of Standards and Purchase, won \$100 by building—out of an old alarm clock, typewriter parts and assorted junk—a

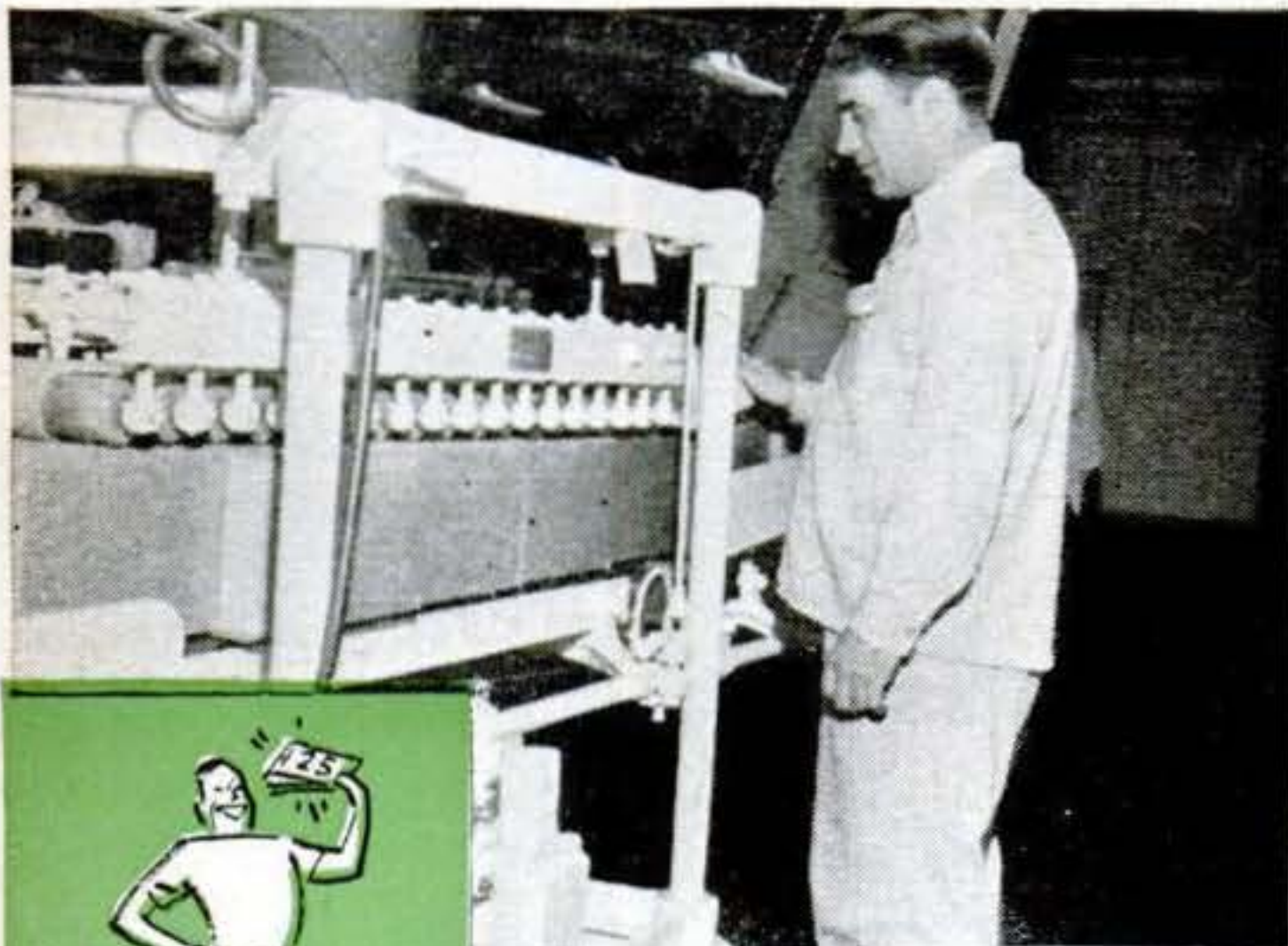

A **JAM** at the bottom of a bottle chute gave Pat Mastrion of Squibb his idea—a bell that would notify the floor above to hold up the flow.

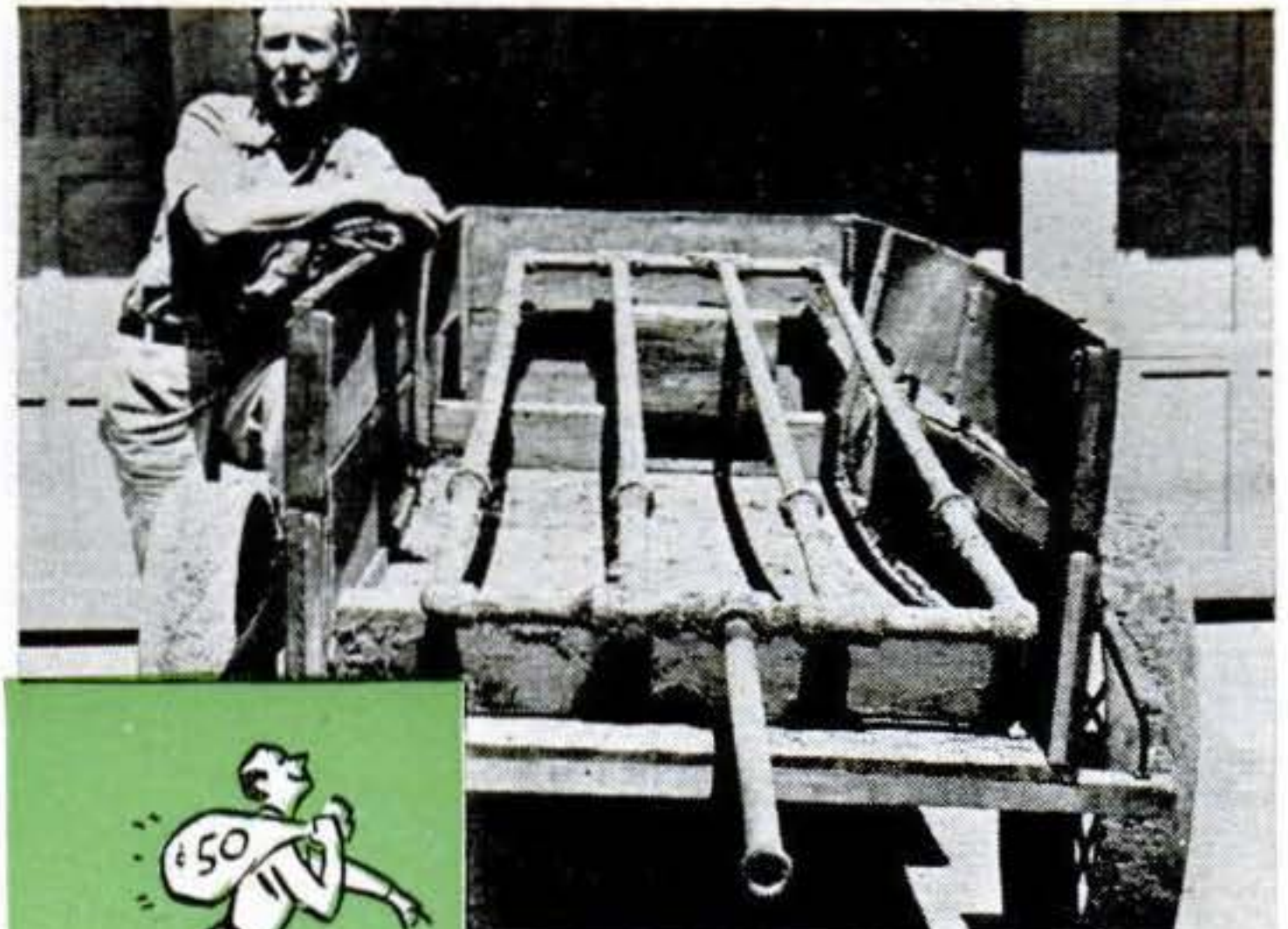

SOIL for farm and greenhouse at a N. Y. State Hospital is now steam-sterilized by these pierced pipes suggested by head farmer Ellis K. Busk.



RABBIT gets the idea of this stanchion suggested by Mrs. Dorothy Hoy and Mrs. Mary Stang to hold him still during inoculations at N. Y. health lab.



H. H. DUCKETT'S time-saving way to replace a jet-engine bearing sounded like a money-saving idea to GM's Allison Division suggestion committee.

device for measuring the slipperiness of various kinds of floor wax.

Outsiders Also Collect

Even outsiders cash in on their ideas. Thirteen-year-old Ronald Wheeler of Iliion, N.Y., recently went to the jet engineers of the Air Force and General Electric with an idea for a "dual afterburner" for increasing jet power. It so impressed the engineers that they flew him in an Air Force plane to GE's Lockheed, Ohio, jet plant to see how the engines are made. Now they're trying to work out a scholarship plan so Ronald can develop his budding genius.

Millions of ideas are brought out of hiding each year by suggestion systems to make life

more convenient and livable for all of us. You never can tell *where* one is going to show up. The recent record-breaking flight of a Pan-American World Airways Clipper from New York to London in nine hours, 21 minutes was made possible by a suggestion submitted by meteorologist Lyle E. Brosche of Bayside, N. Y.

He suggested a new system of flight forecast based on the premise that the shortest route is often attained by flying in a sweeping curve and utilizing tail winds. Now this method is often credited with saving an hour or more in a trans-Atlantic flight. Brosche won \$500 from the company and \$250 from the Air Transport Association.

[Continued on page 234]



A \$1,950 JACKPOT went to Morton Gorman, a Westinghouse machine operator at South Philadelphia. Because of his suggestion, four jet-engine flanges, instead of three, are made from same piece of stock in same operation.



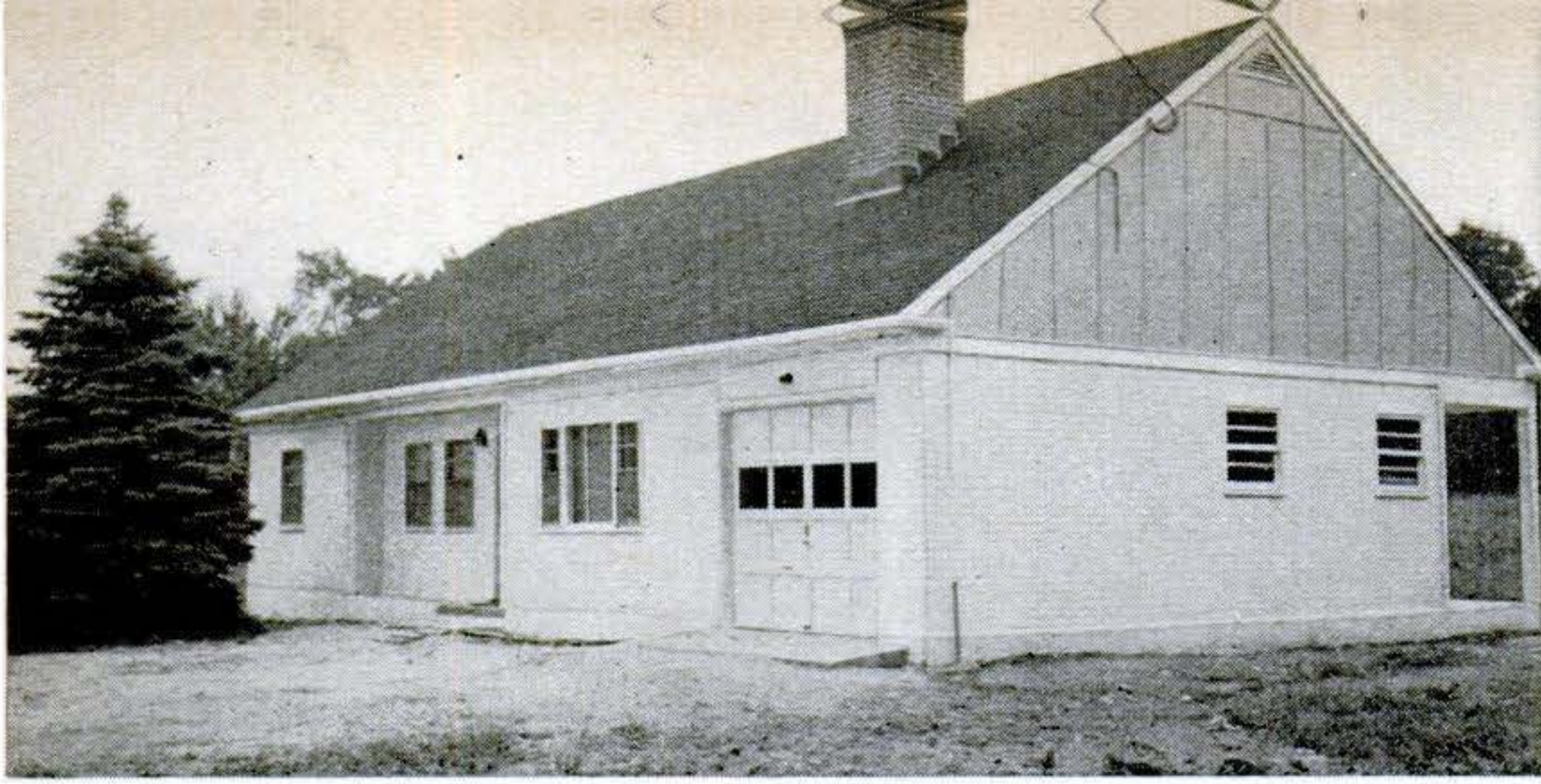

FINISHED JOB, built with new precast wall units, has six rooms and attached garage. This home, near Greenwich, Conn., was built on concrete slab, but units can be used in houses with basements just as easily.

Precast Walls Go Up in a Day

Ready-to-bolt slabs for concrete house rise nearly as fast as a circus tent.

By Denis Sneigr

CONCRETE slabs bolted together to form walls are cutting construction time and costs for home buyers.

With the new sections, all exterior and

interior walls of a six-room house can be put up in one day by six unskilled workmen and a foreman. On one job, all the interior and exterior walls for a 4½-room home were erected in 4½ hours.

This time saving means dollar savings to



CALKING COMPOUND ON EDGES insures tight joints. Spaces between uprights on inside faces are just wide enough for insulation batts.

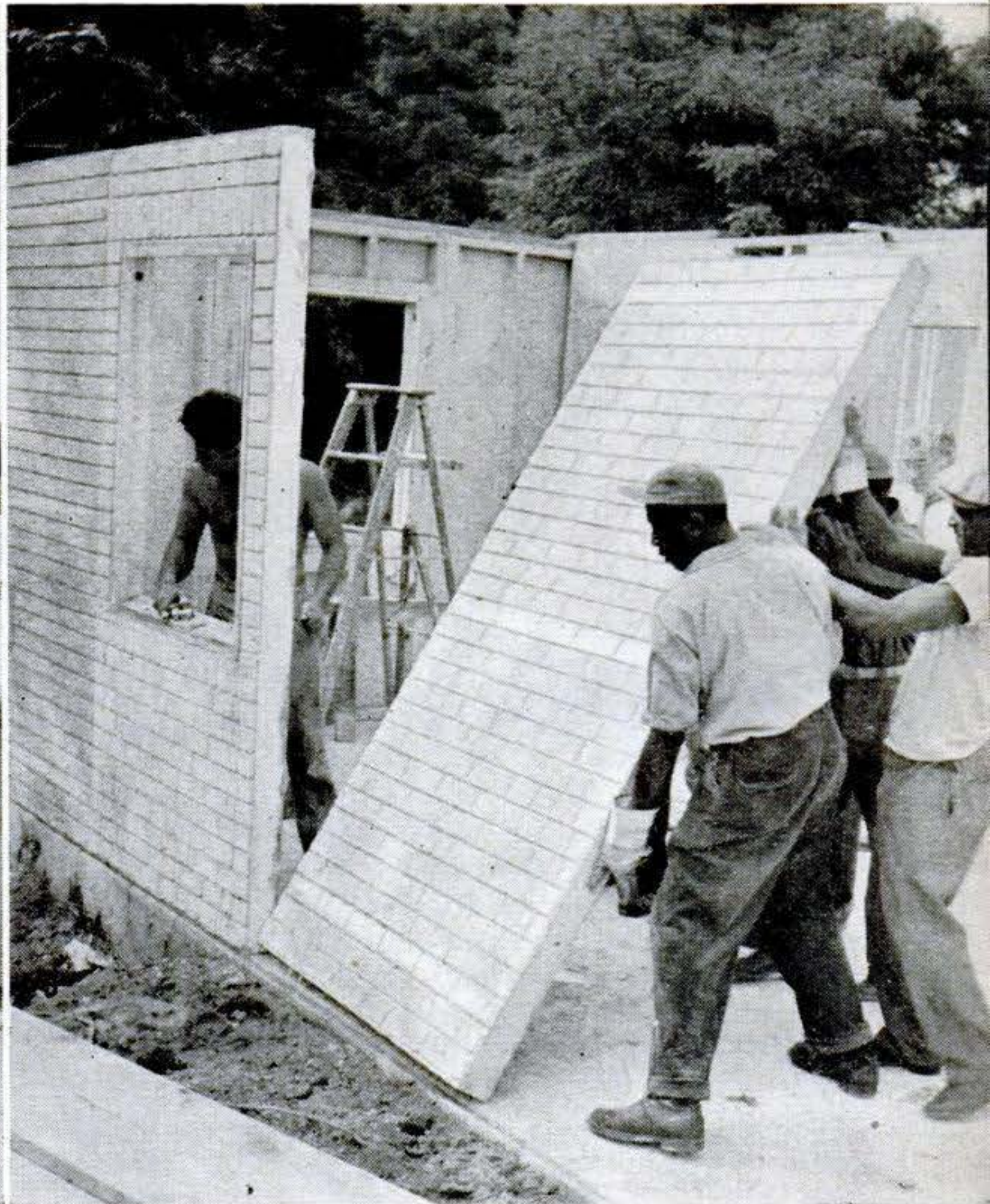

THIS 200-LB. WALL SLAB can be handled easily by four men. It measures four by eight feet. Half units are two by eight feet.



BOLTS THROUGH EDGES tie each wall section to the next one (left above). Bottoms are anchored by lag screws into wooden sleepers

cast in concrete slab. Common wire nails can be hammered into the walls. Plates can be nailed or bolted to top of the walls.

the buyer. Gelbman, Inc., of Yonkers, N. Y., maker of the units, says the saving will be about 20 percent over conventional construction when the units are in mass production. Right now, the difference is about 15 percent.

The units are cast of lightweight aggregate, reinforced with quarter-inch rods and wire mesh. They are one inch thick, except on the edges and along the two vertical members, where the thickness is four inches.

They are cast and seasoned at the company's Bronx, N. Y., plant.

Three exterior wall finishes are available—stucco and simulated brick or stone veneer. Interior wall panels are delivered to the job with the scratch coat already on them. They need only two more coats of plaster to make a finished interior wall.

The units are so compact all the panels for a six-room home can be hauled to the job on one truck. **END**

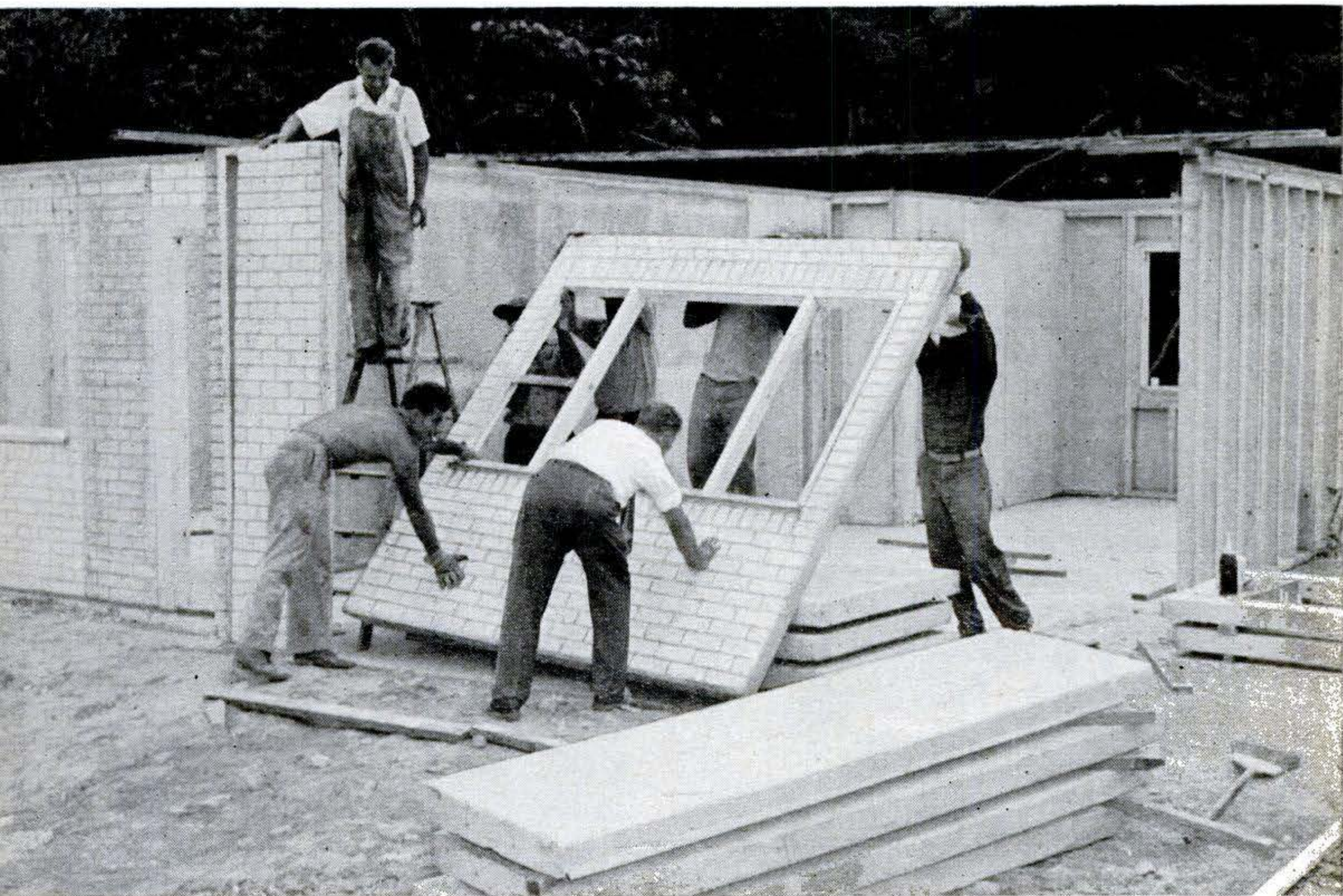

PICTURE-WINDOW PANEL is raised. Carpenter (on ladder) waits to nail down plate. Panels are available with openings for three sizes

of standard windows and doors. Panels come with door and window bucks cast in openings, ready for finish framing.



Biggest Airliner to Show Movies

LANDING at London Airport (above) is the world's biggest civil landplane—the 177-foot Bristol Brabazon I. Built to carry 100 passengers and a crew of twelve, the giant British airliner is now being used as a flying laboratory to develop an improved Brabazon II—whose luxurious accommodations (right) will even include a moving-picture theater. Powered by four coupled pairs of gas turbines, the Brabazon II is expected to provide nonstop service between London and New York by 1953.

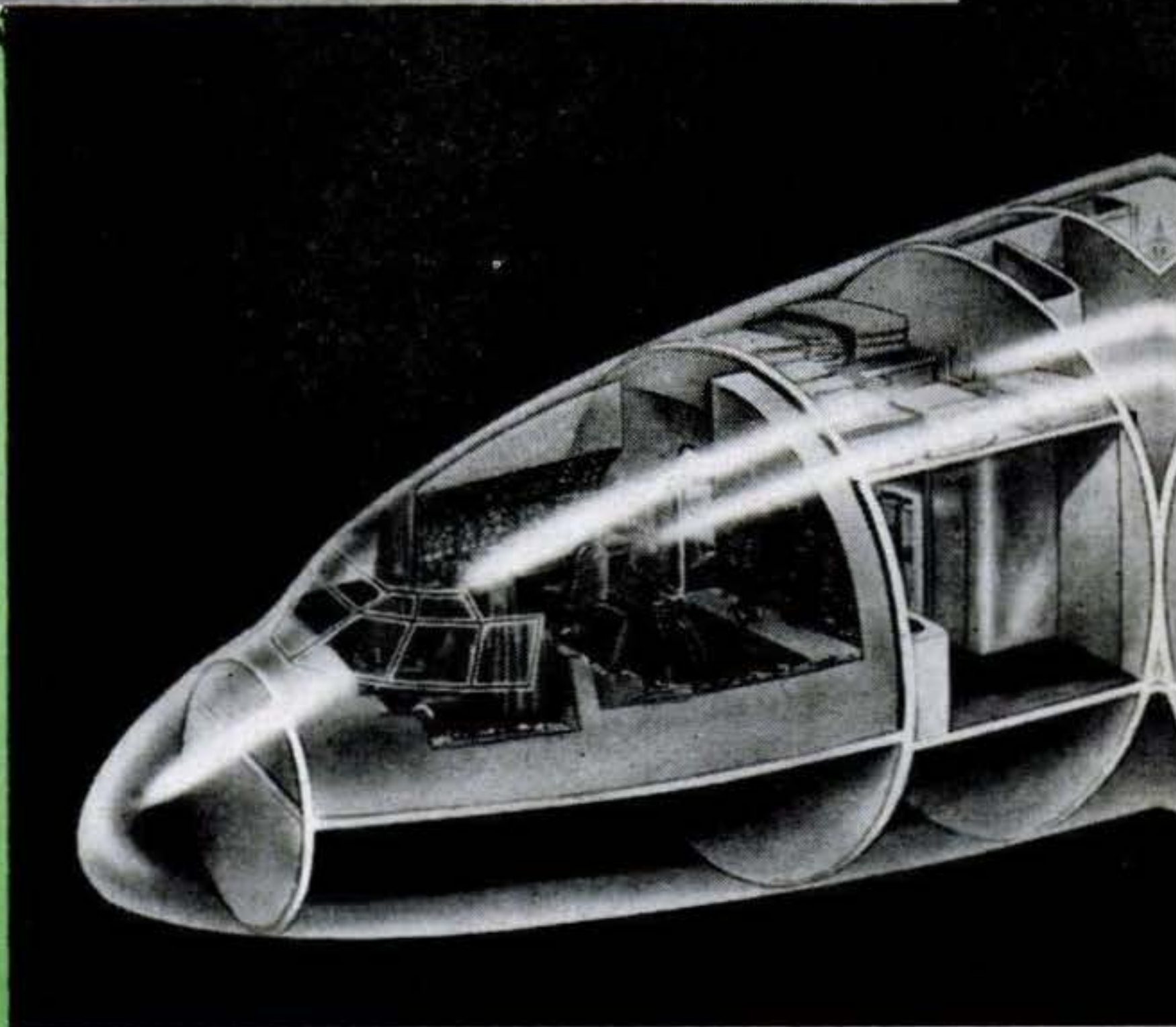

“Shade” to Aid Atom Defense

HEA T radiation from an A-bomb blast would scorch the inside of the painted metal “lampshade” shown below except where shadows were cast by the brass center rod and “shade’s” upper rim. By means of lettered and numbered grid lines, these unscorched areas would show direction of blast. With data recorded by two or more such devices, height and center of blast could be quickly plotted for rescue crews.

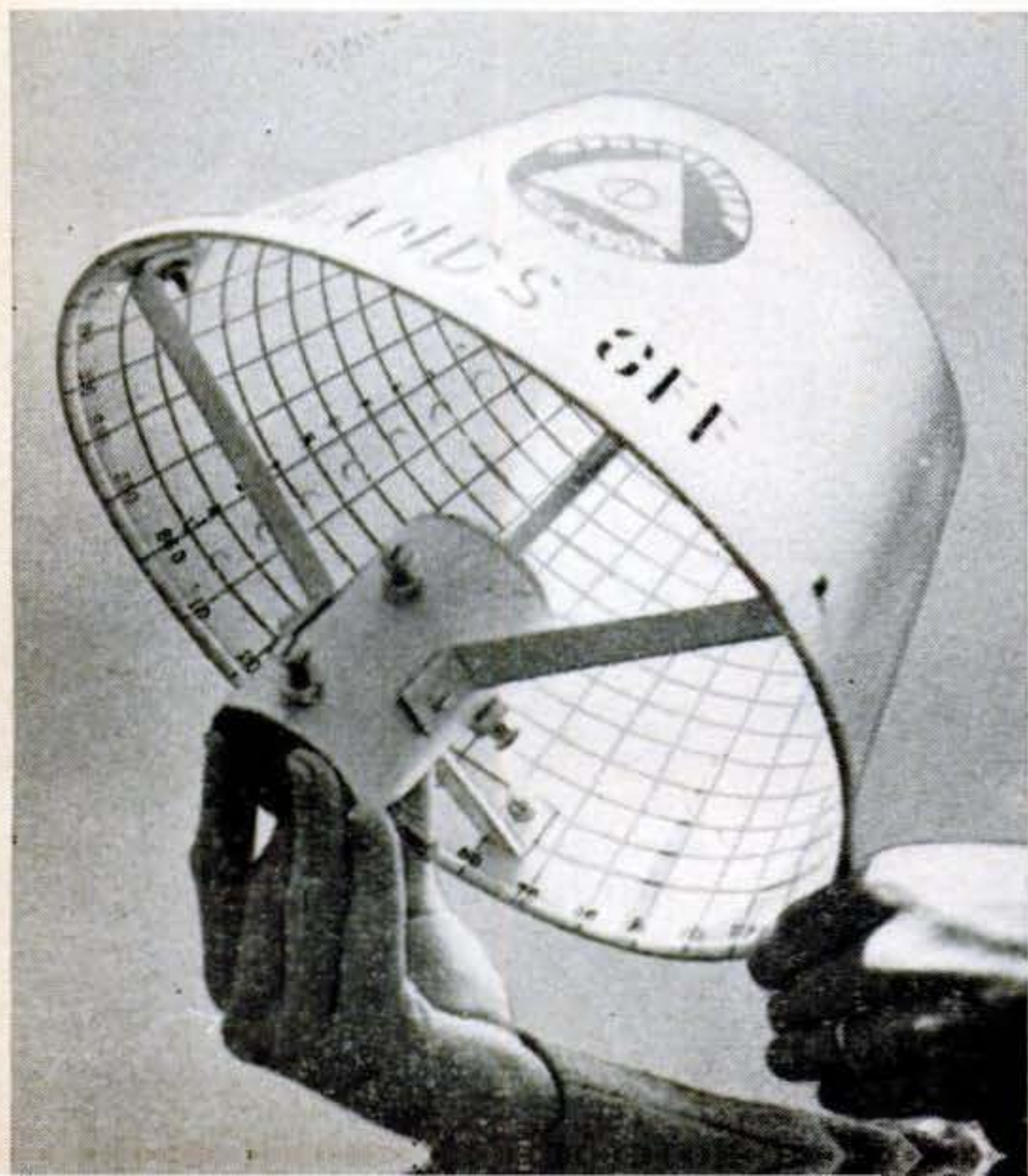

Armor to Protect Troops

GI **B**ELOW is modeling a new plastic helmet and lightweight armored clothing developed to stop shell fragments and bullets. Under an outer vest he wears a nylon liner. The leg protectors are glass-fiber cloth.



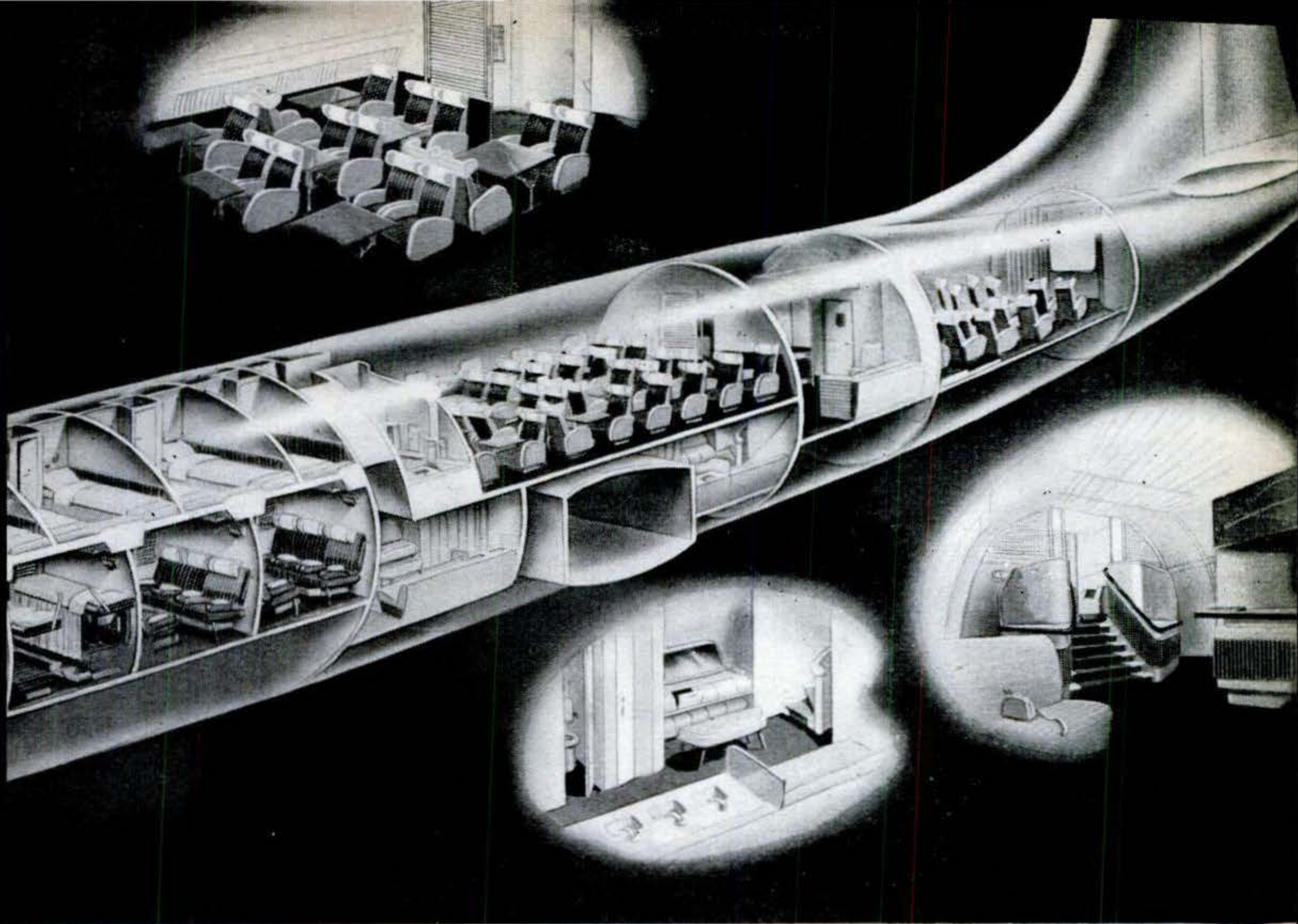

Steel Ski Jump Brings Winter Sport to City Fans

THE 155-foot-high ski jump below was made of 1,200 steel frames of the scaffold type used in building construction. A wooden runway was covered with straw and sprayed with 40 to 50 tons of "snow" pro-

duced by ice-crushing machines. The slide was built for the Portland, Ore., Rose Festival last summer. Some enthusiastic jumpers ran out of snow and took landing spills in straw extending beyond the slide.

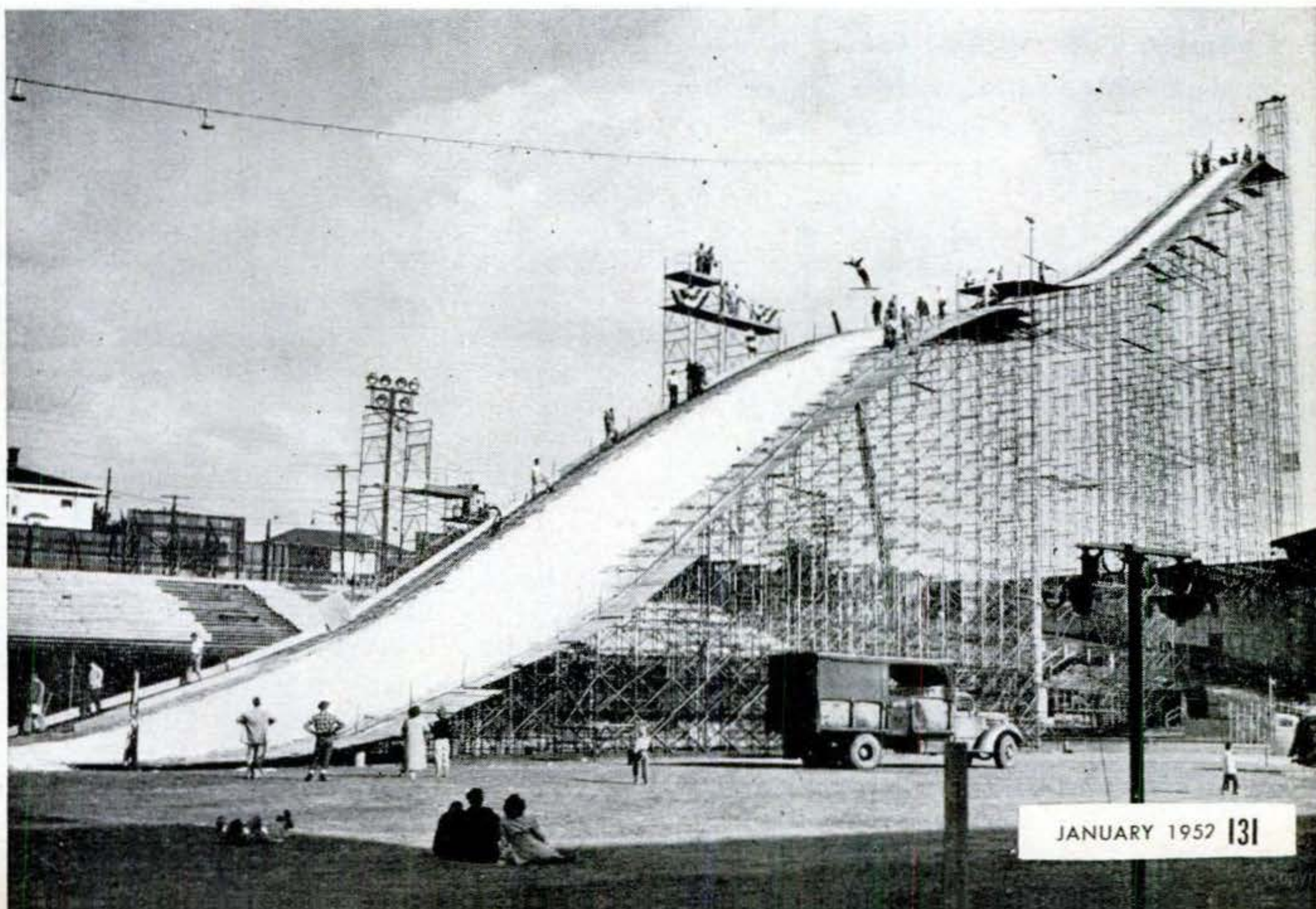

How Asphalt Tile Is Made



This popular flooring now comes in bright colors because it isn't really made from asphalt any more.

DESPITE its name, there is no asphalt in the asphalt tile shown above and, on the facing page, being made at the Brooklyn plant of Kentile, one of the world's largest manufacturers of this tough, colorful and popular floor covering.

The misnomer goes back to World War I, when many factory floors and ship decks were covered with a mastic made of asbestos fibers bound together with asphalt. This was mixed with a solvent to make a sticky paste. Six or seven layers were applied with a trowel—and each layer had to be allowed to dry.

An improvement came when the solvent was eliminated, and the asphalt and as-

bestos were rolled into sheets that could be laid down and walked on immediately. Asphalt was still the flaw, however, since it is black. Even when a little was used, in an effort to produce light colors, only muddy browns and tans resulted.

Then, around 1930, asphalt was replaced as a binder by light-colored synthetic resins, making possible the brightly hued floor coverings you see in homes all over the country. Some manufacturers still use asphalt, however, for dark-colored tiles.

Since then the industry has been booming. This year it expects to turn out some 640,000,000 square feet—enough asphalt tile to cover all of Manhattan Island.

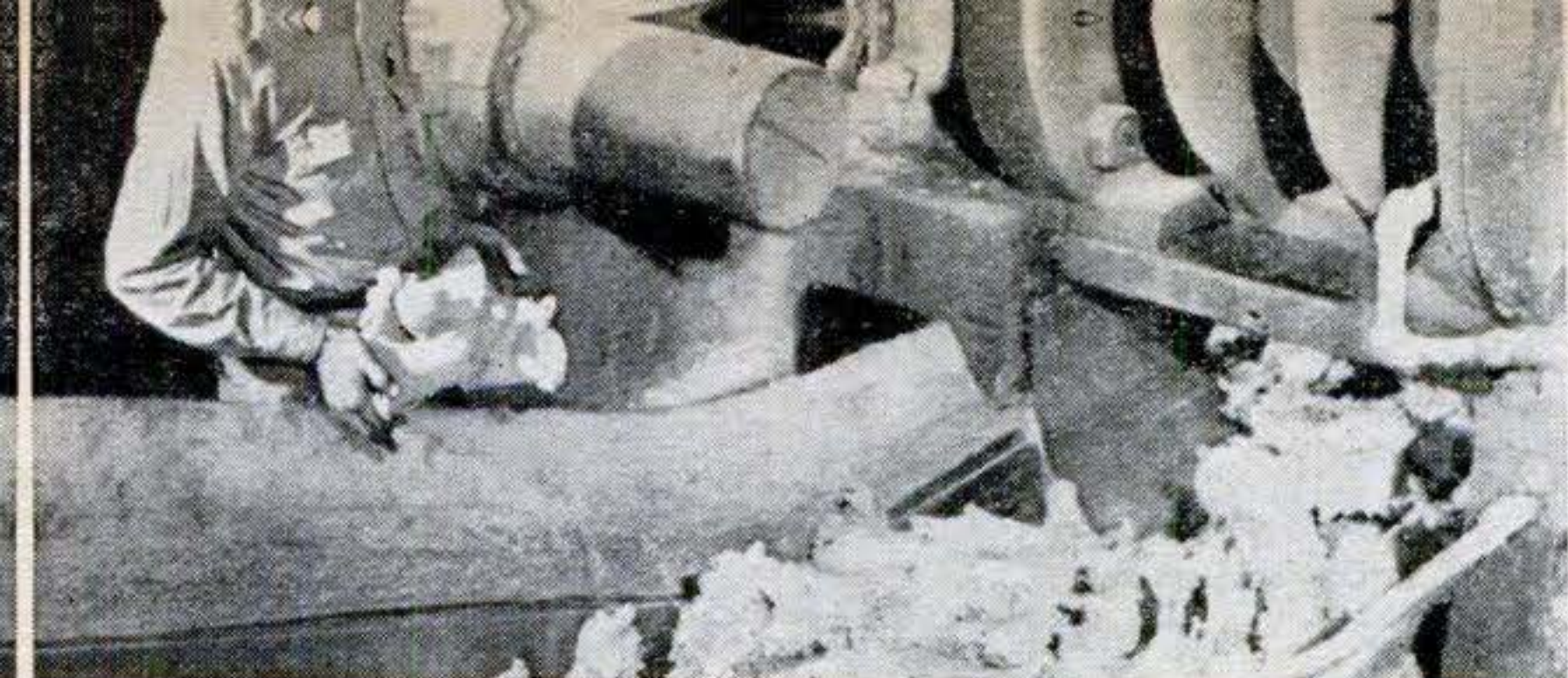

1 THIS DOUGHY MASS coming out of a Banbury mixer and dropping onto a conveyor belt is the raw beginning of asphalt tile. The ingredients, now thoroughly mixed, are a blend of asbestos, pitches, synthetic resins, pigments and limestone filler.



2 MARBLEIZING begins at the sheeting mill. Here an operator adds pigment chips (a modified tile mix) to doughy mass that came out of the Banbury. When it is now fed between rollers, the chips are distributed throughout. Plain-colored tile is also made.

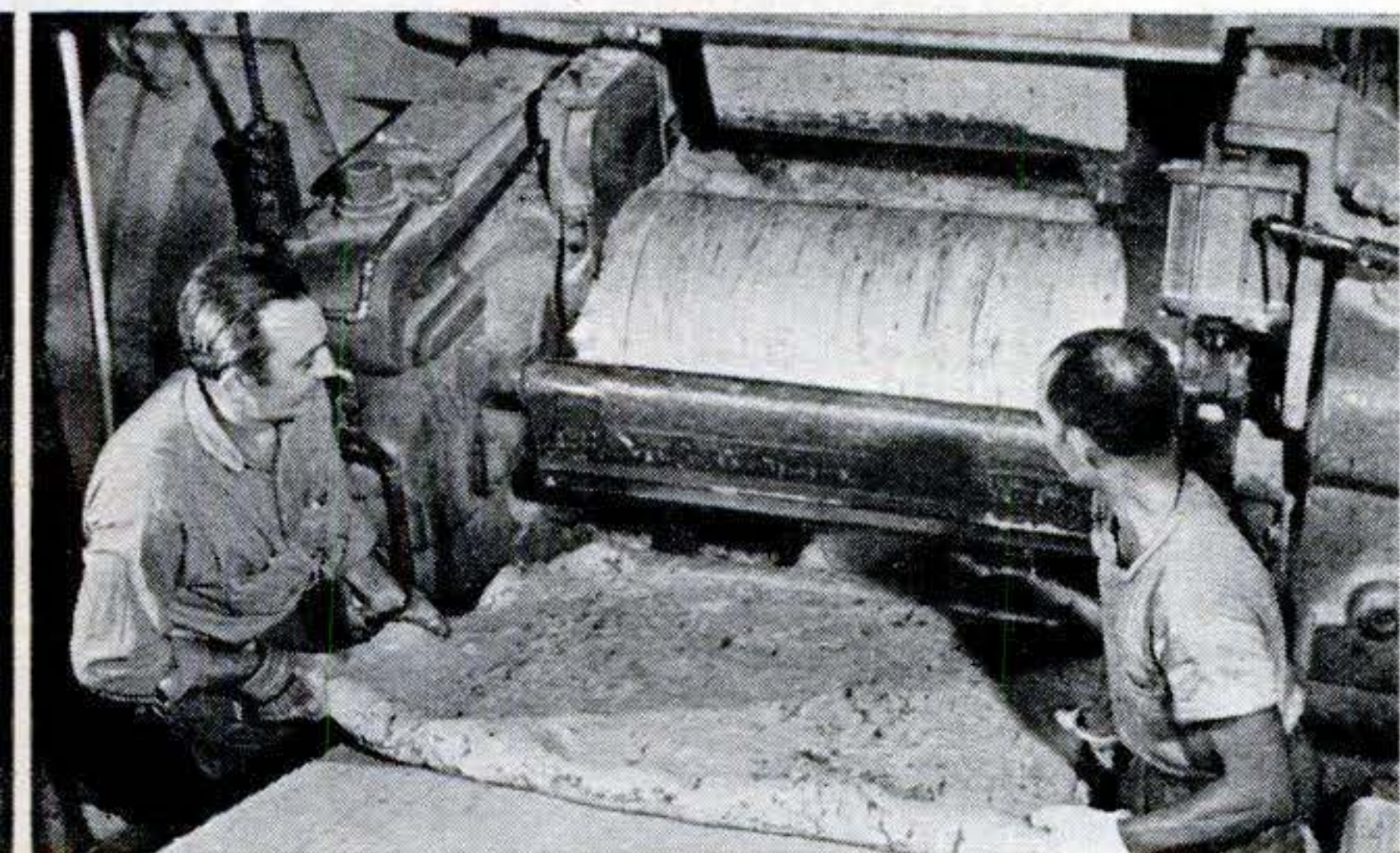

3 OUT OF THE SHEETING MILL comes a caramel-like "blanket," about three-quarters of an inch thick, that has absorbed the pigment chips. Here gloved workers transfer hot blanket to conveyor going to calendering machines, which will make it thinner.

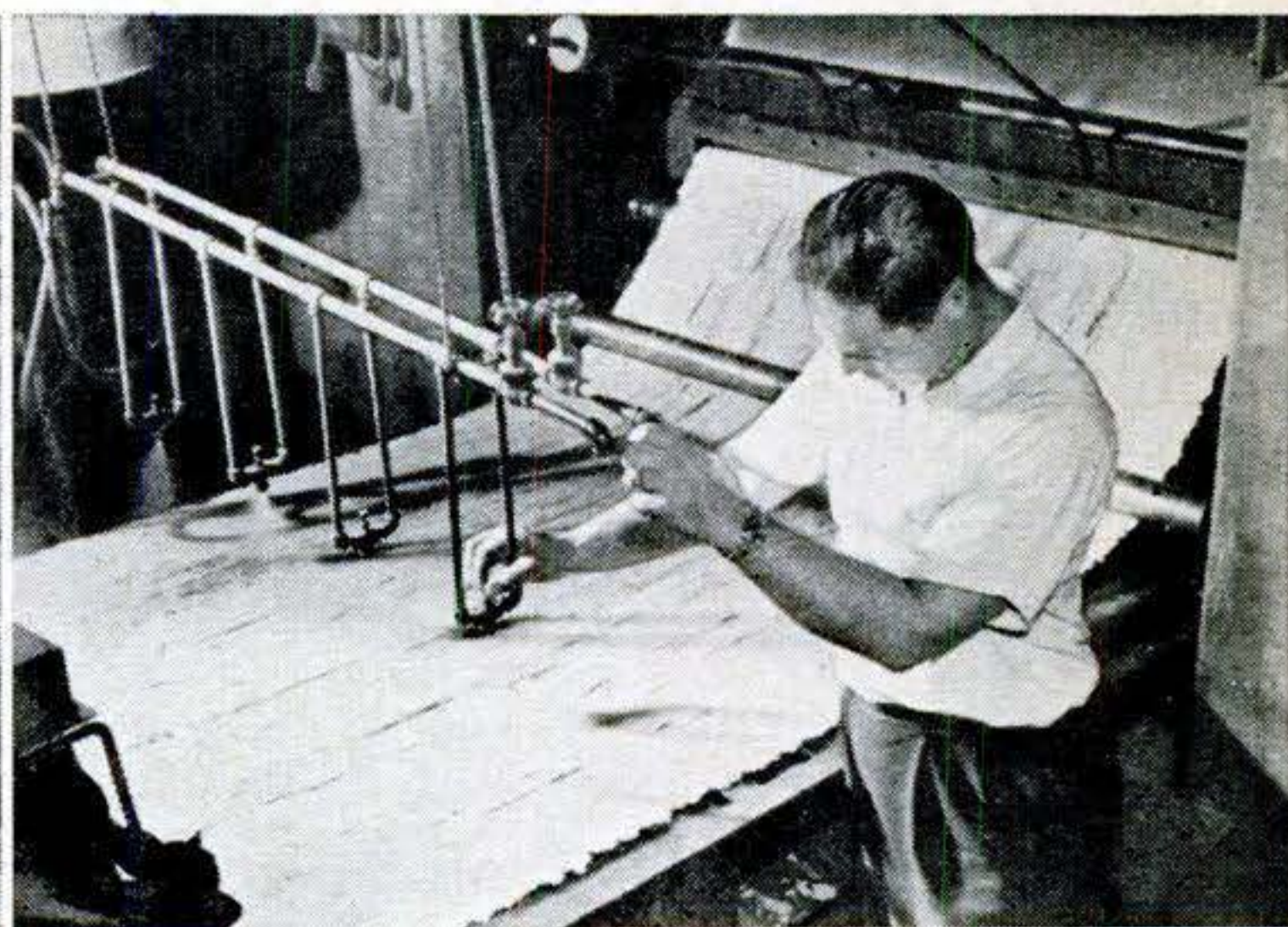

4 THE SHEET, after going through a calendering operation, has been reduced to either of two thicknesses— $\frac{1}{8}$ inch or $\frac{3}{16}$ inch. Here an operator is adjusting wax sprays. The sheet also passes under cooling sprays and polishing buffer.

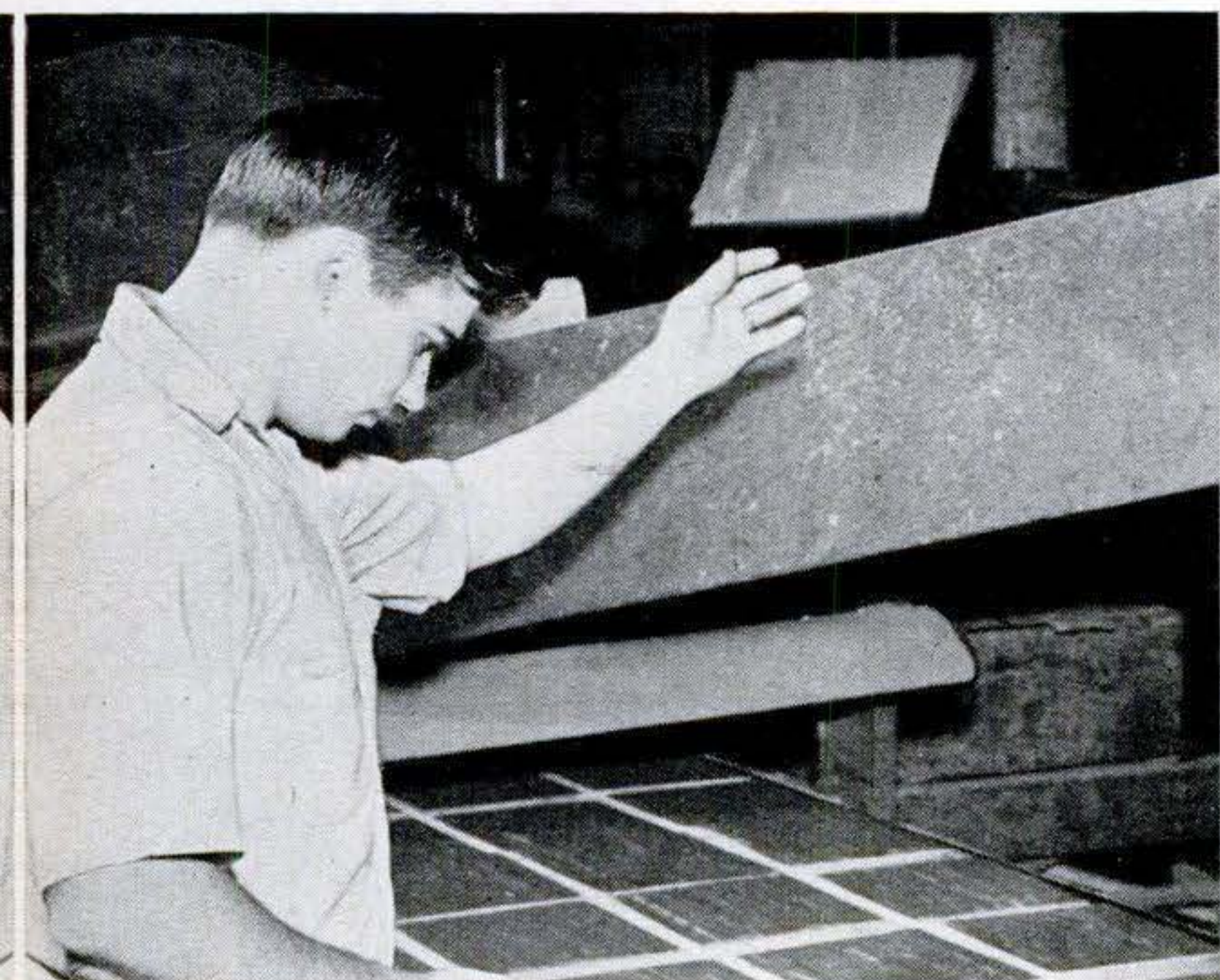

5 A CUTTING MACHINE, using special dies made by Kentile, makes several nine-inch squares at one cut. Inspector watches for imperfect tiles, which are sent back to the Banbury mixer. Refrigerated steel belt further cools tile on way to packing department.



6 CUSTOM-MADE TILES carry out any design a customer wants. Here craftsman is forming a camellia of many cut-out parts that will fit like a jigsaw puzzle into molds cut into a four-tile background. Special lamp keeps tiles pliable as he works. END

4-Deck Parking Lot Uses Drawbridges

A FOUR-LAYER parking lot is helping to relieve traffic jams in Beverly Hills, Calif. Put up on a lot that used to hold 100 cars, it accommodates 450.

The new garage is made of light-gauge steel decks supported by slender steel columns. Prefabricated sections in a few standard shapes and sizes were assembled like scaffolding by workmen whose only tools were air wrenches. The whole thing was bolted together in 15 days. If the lot is needed later for a permanent building, the garage can be taken down and reassembled somewhere else. Only loss would be the foundation piers.

To save space, ramps between floors work like drawbridges, lifting out of the way of traffic on the floor below. Thanks to counterweights, they are raised and lowered by small $\frac{1}{2}$ -horsepower motors—instead of the heavy machinery that elevators would require.

The unusual structure, serving the Beverly Hills Medical Center, was designed by Ellis E. White, an aeronautical engineer, and built by the Multi-Deck Corp. of America.



CARS ARE "FUNNELED" into narrow trackways of ramps and parking stalls by converging curbs. Rollers let wheels slip sideways.

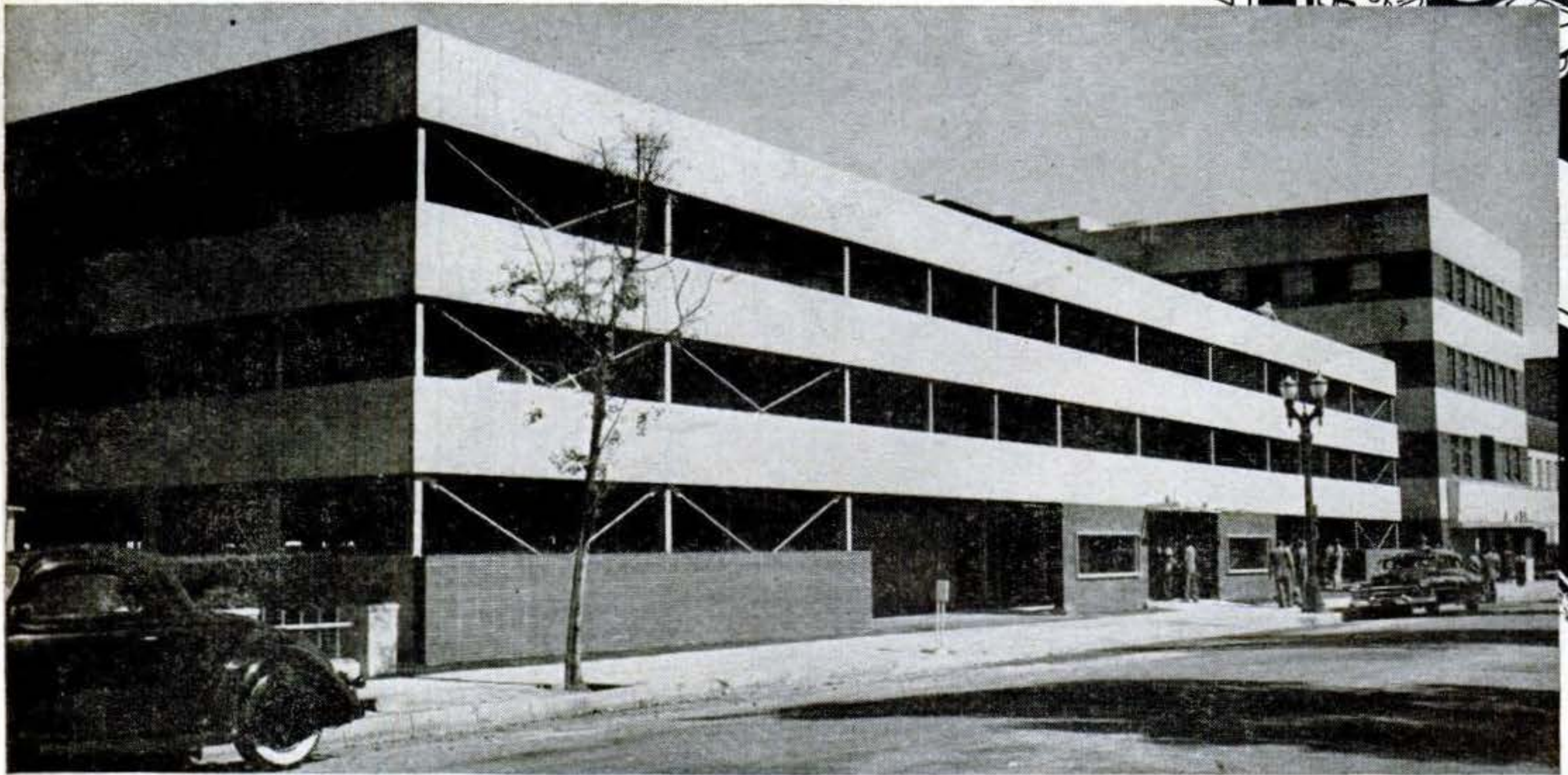
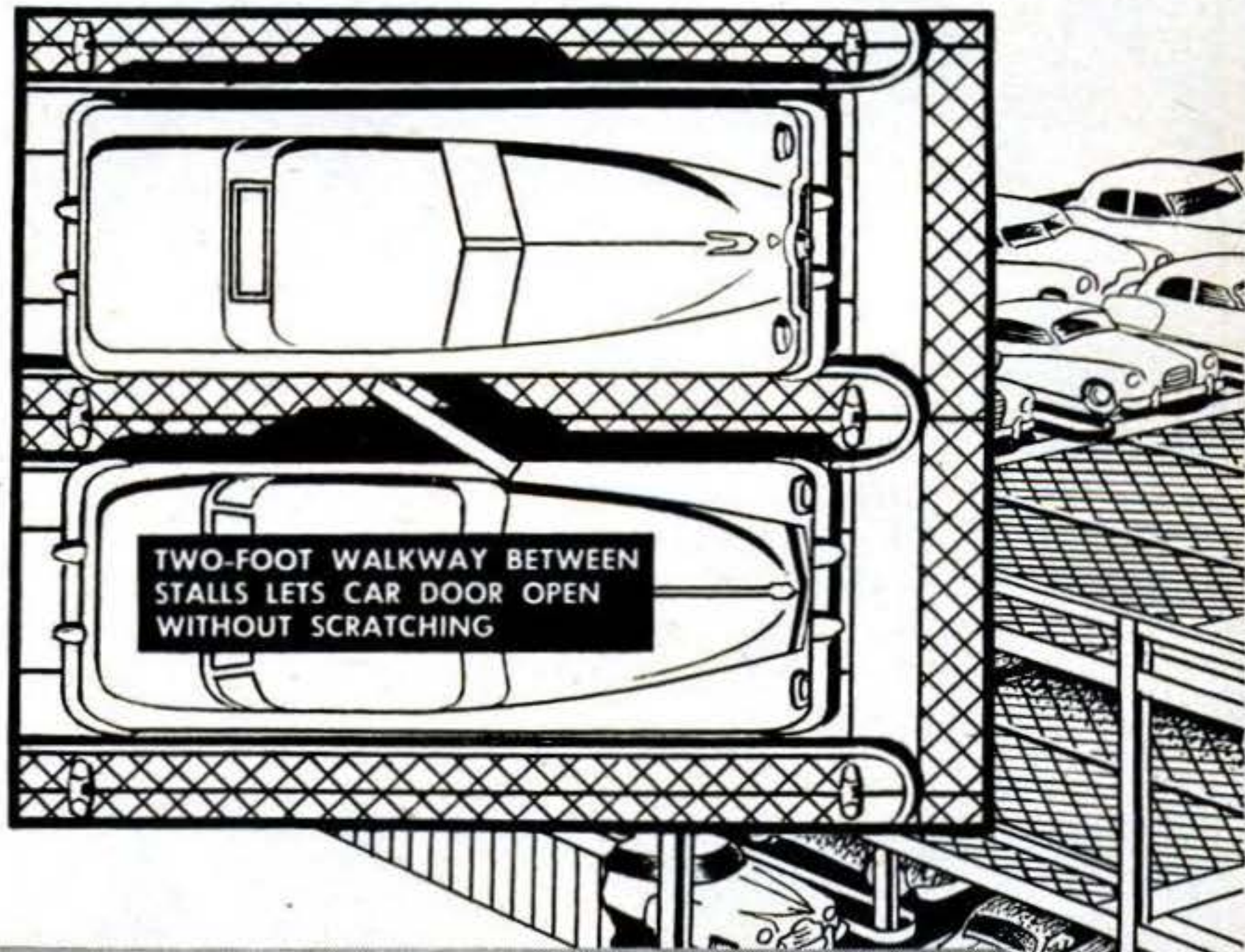

FOUR-FLOOR GARAGE is about half as tall as four-story building at right. Even when all

stalls are filled, it's never necessary to move more than one car to get another out.

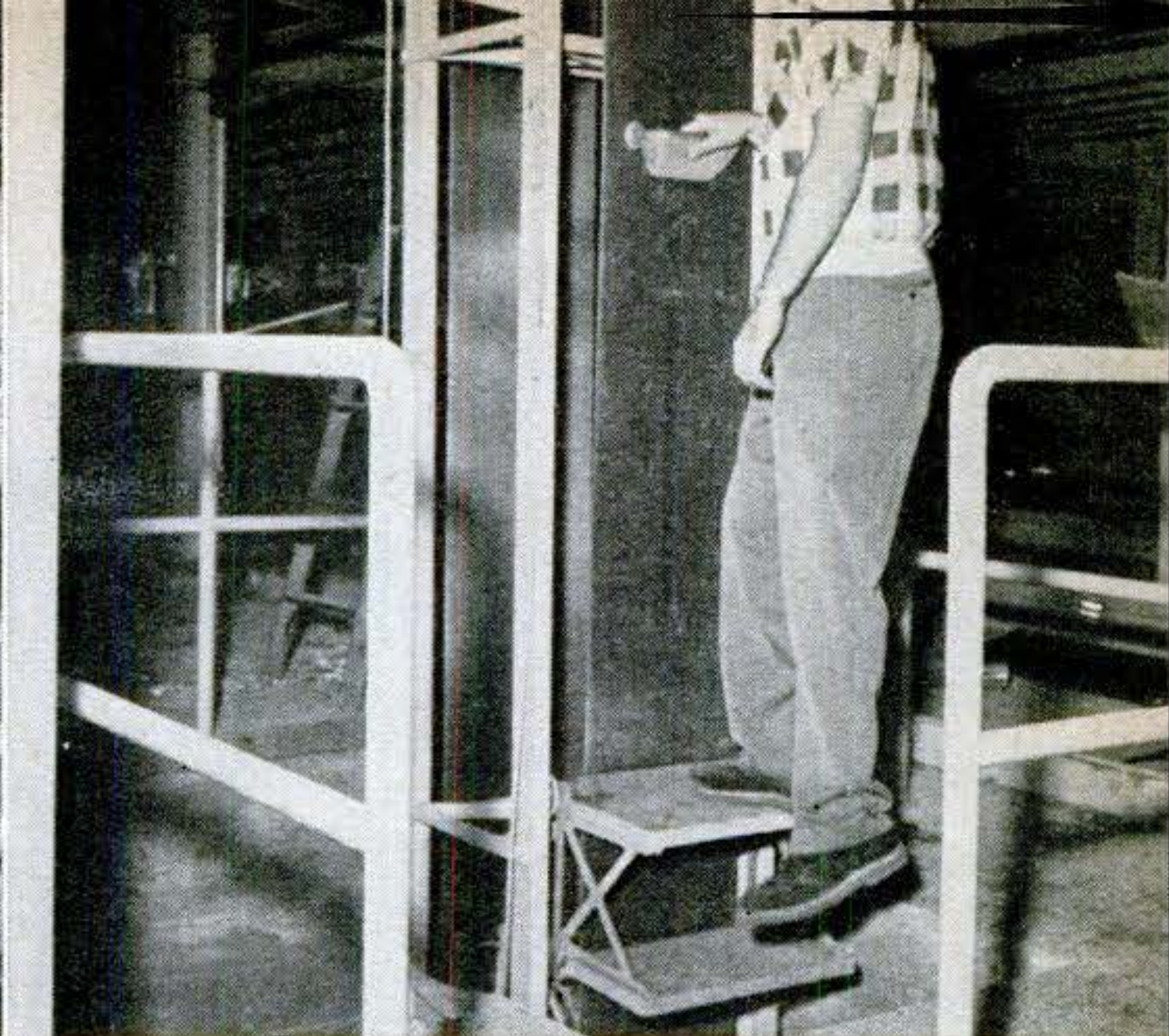

PUSH BUTTONS, operated by attendant from car, lower ramp to connect floors or raise it to let him drive across bridge on same floor.

ENDLESS-BELT ELEVATOR carries attendants up and down. Ground floor to roof takes 15 seconds. One minute later, customer gets car.

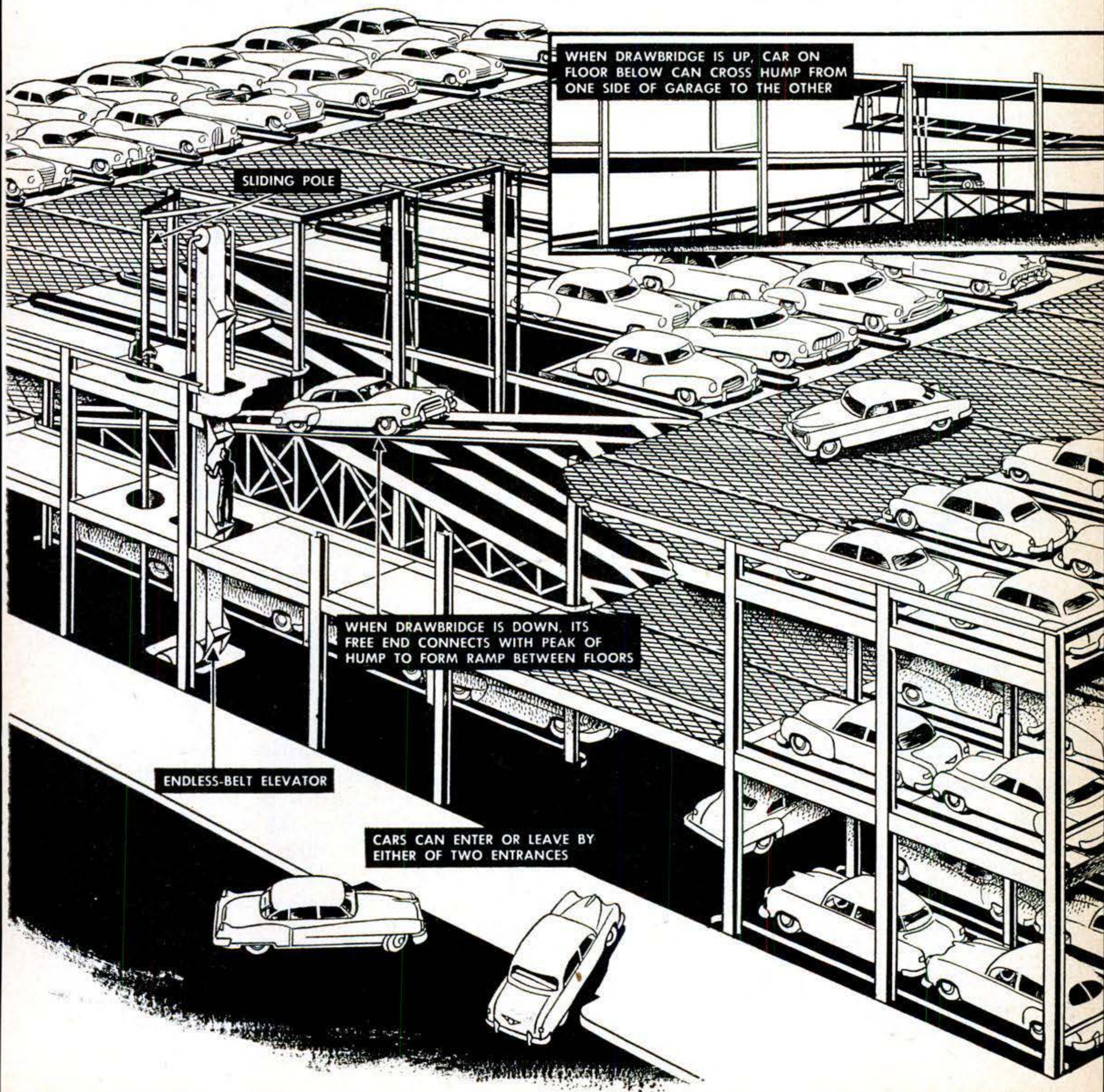

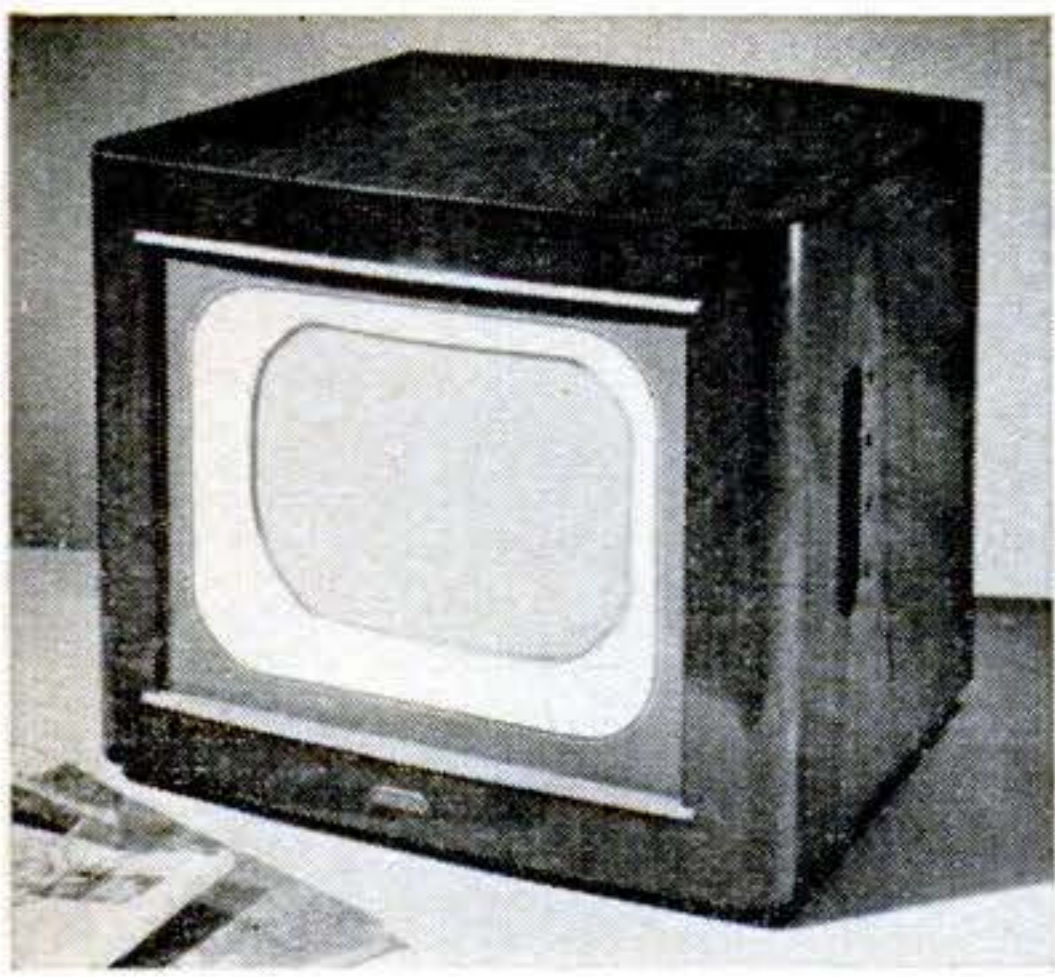

British TV Set Built Around Picture Tube

A CIRCULAR frame wraps the chassis around the picture tube of this unusual British TV set. Rotating the frame makes each of the four "paddle-wheel" subchassis accessible for servicing or replacement. Made by Murphy Radio Ltd., the receiver needs no channel selector, as Britain's three television areas have but one station apiece. Replacing the RF subchassis "tunes" the set for a different area.

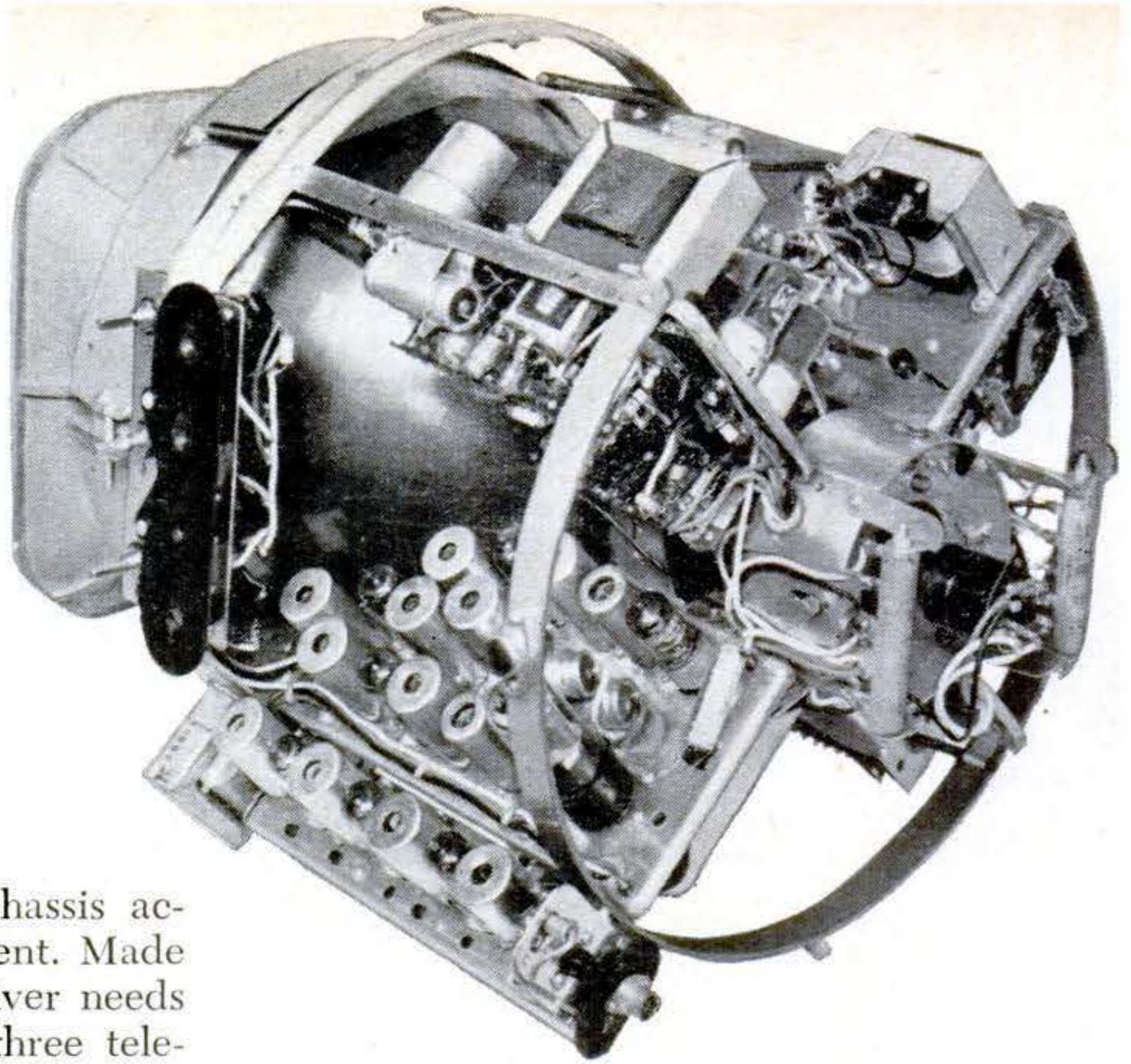

ENCIRCLING PICTURE TUBE in new British TV set are four subchassis, each readily accessible for service. Smaller view shows exterior.

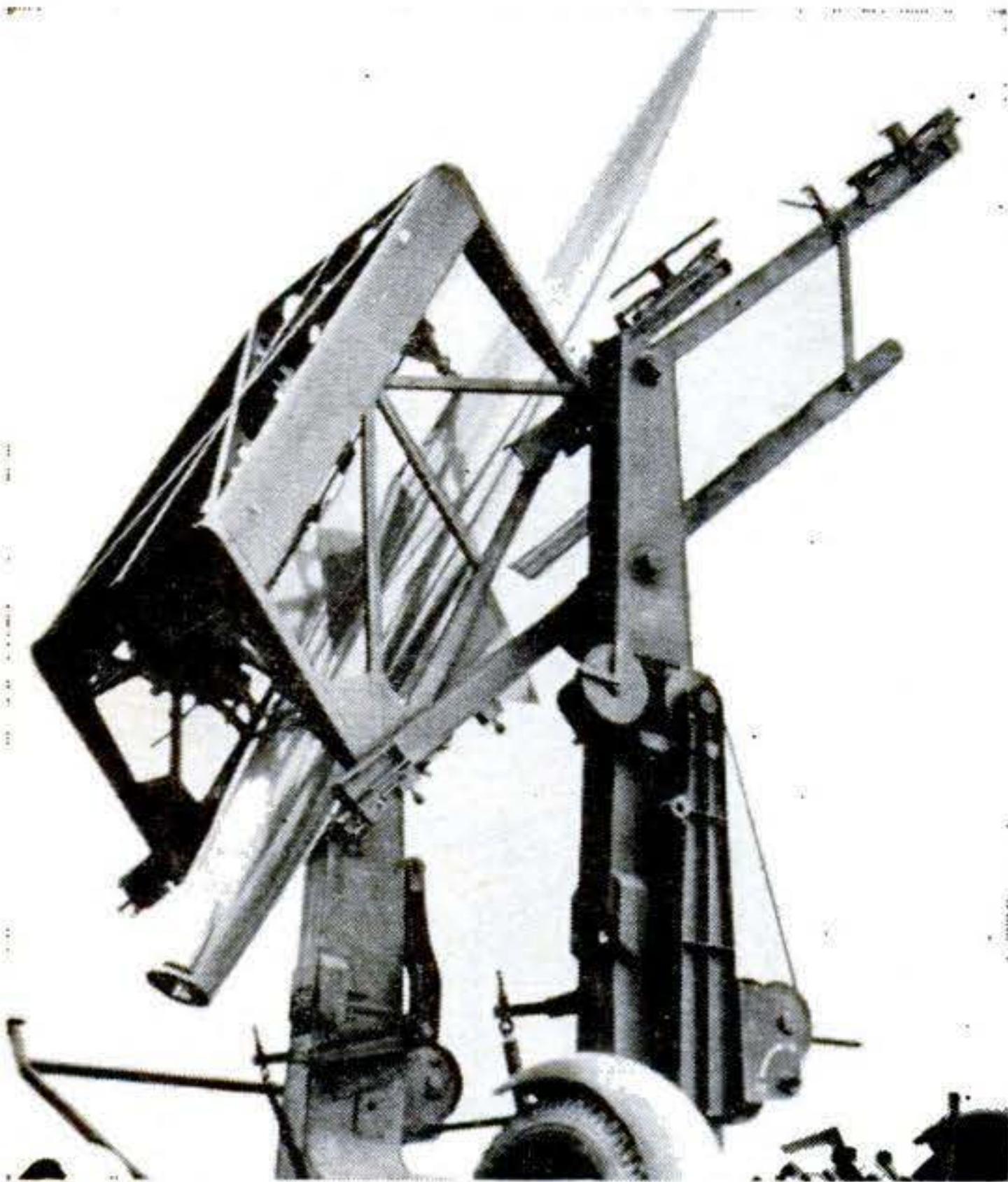

"Gun" Fires Rocket Missile

TO BRING down a high-flying enemy plane, the 16-foot rocket above is fired from a launcher that elevates and traverses like an anti-aircraft gun. A nearby trailer steers the guided missile to its target by radar. The famous Swiss armament firm, Oerlikon, has designed and exhibited the system.

Light Bottles Won't Break

LIGHT enough to balance in a child's hand, smashproof one- and two-gallon bottles of polyethylene plastic have been developed for shipping corrosive liquids. They can be dropped 45 feet on concrete without breaking, and flex without cracking if contents freeze.



A limited supply of polyethylene restricts the present output of bottles by the Plax Corp., Hartford, Conn., to military use only.

Sulfur Bonanza to End Shortage

EXPLORING for oil at the tip of the Mississippi River delta in Louisiana, prospectors have struck the biggest deposit of sulfur found anywhere on earth in the last 20 years. To exploit the find, the Freeport Sulphur Co. will set up a sulfur mine expected to cost \$10,000,000 to \$15,000,000, and to begin operating in 1953. Experts believe the discovery will relieve a world-wide shortage of this raw material for making sulfuric acid, one of the most useful of chemicals.



Mr. Fogg Went Via:

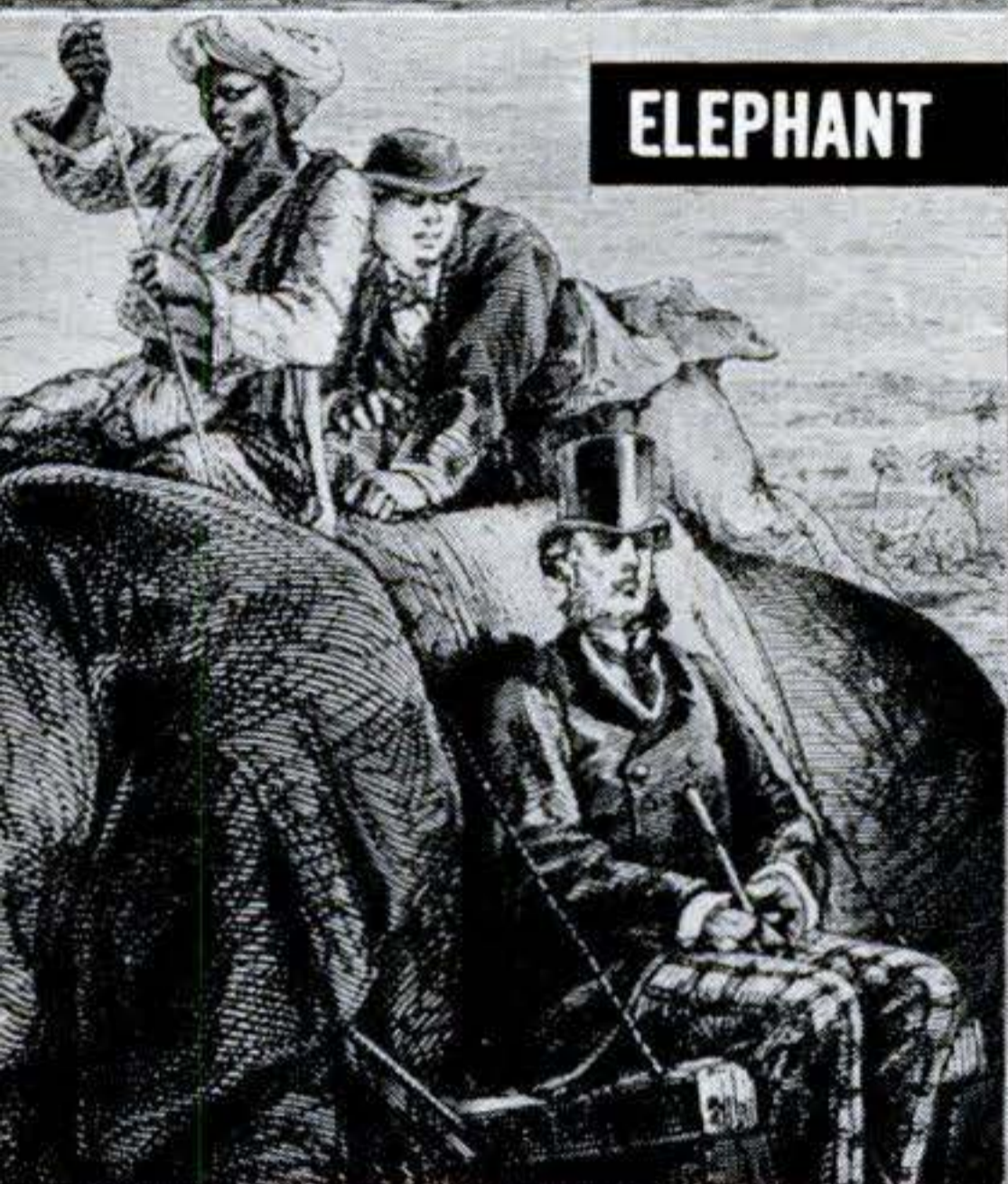

ELEPHANT

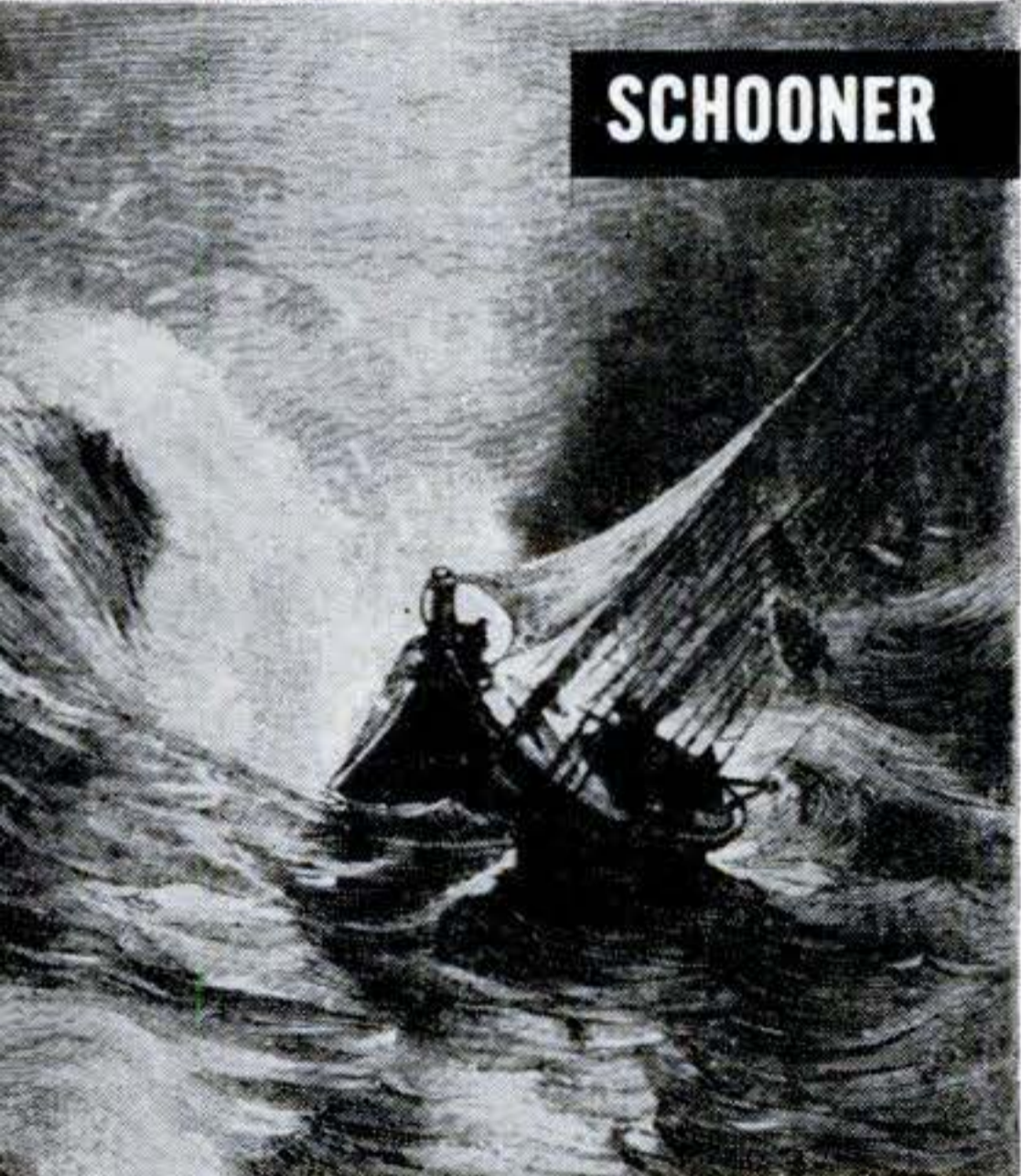

SCHOONER

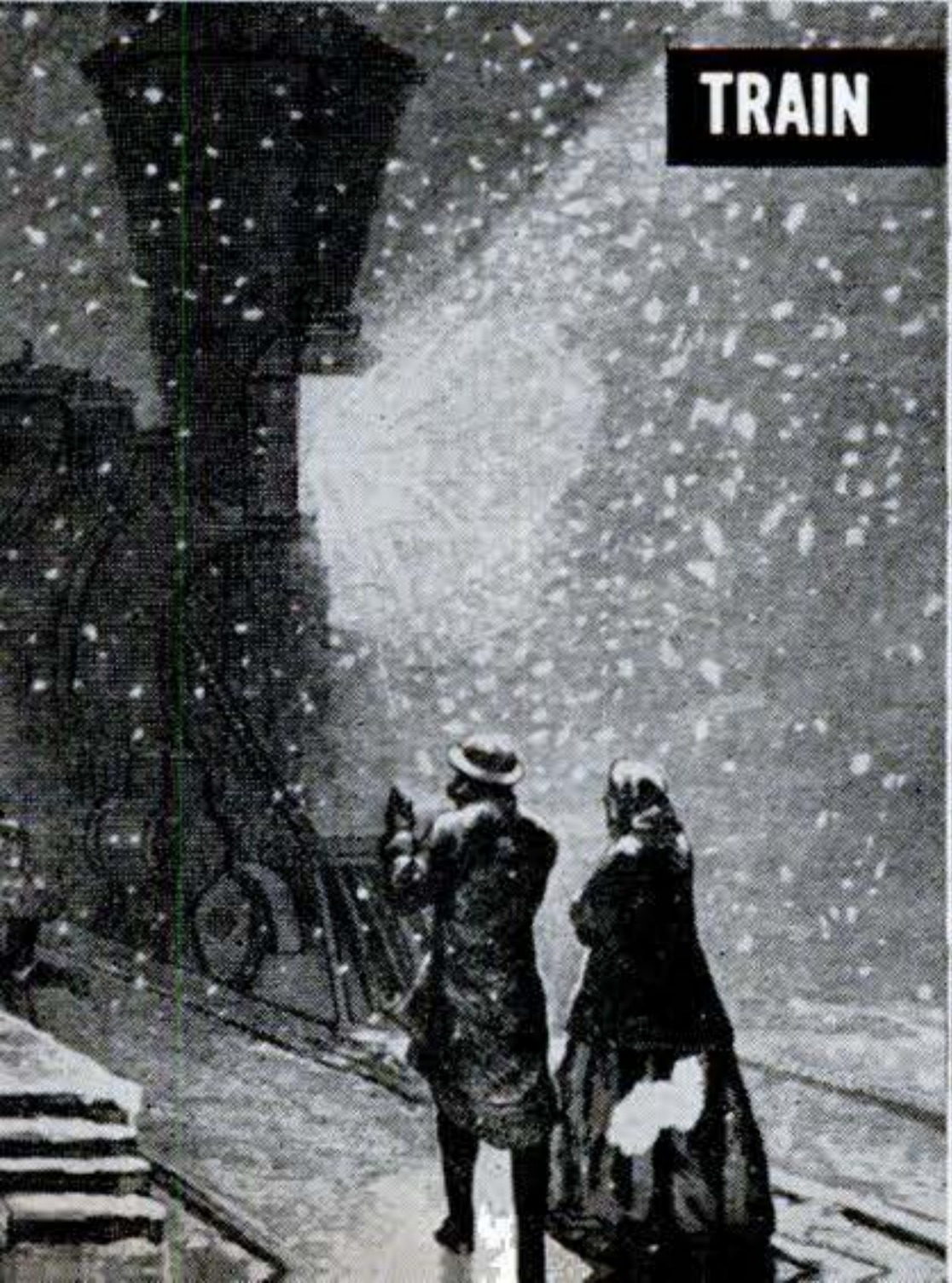

TRAIN

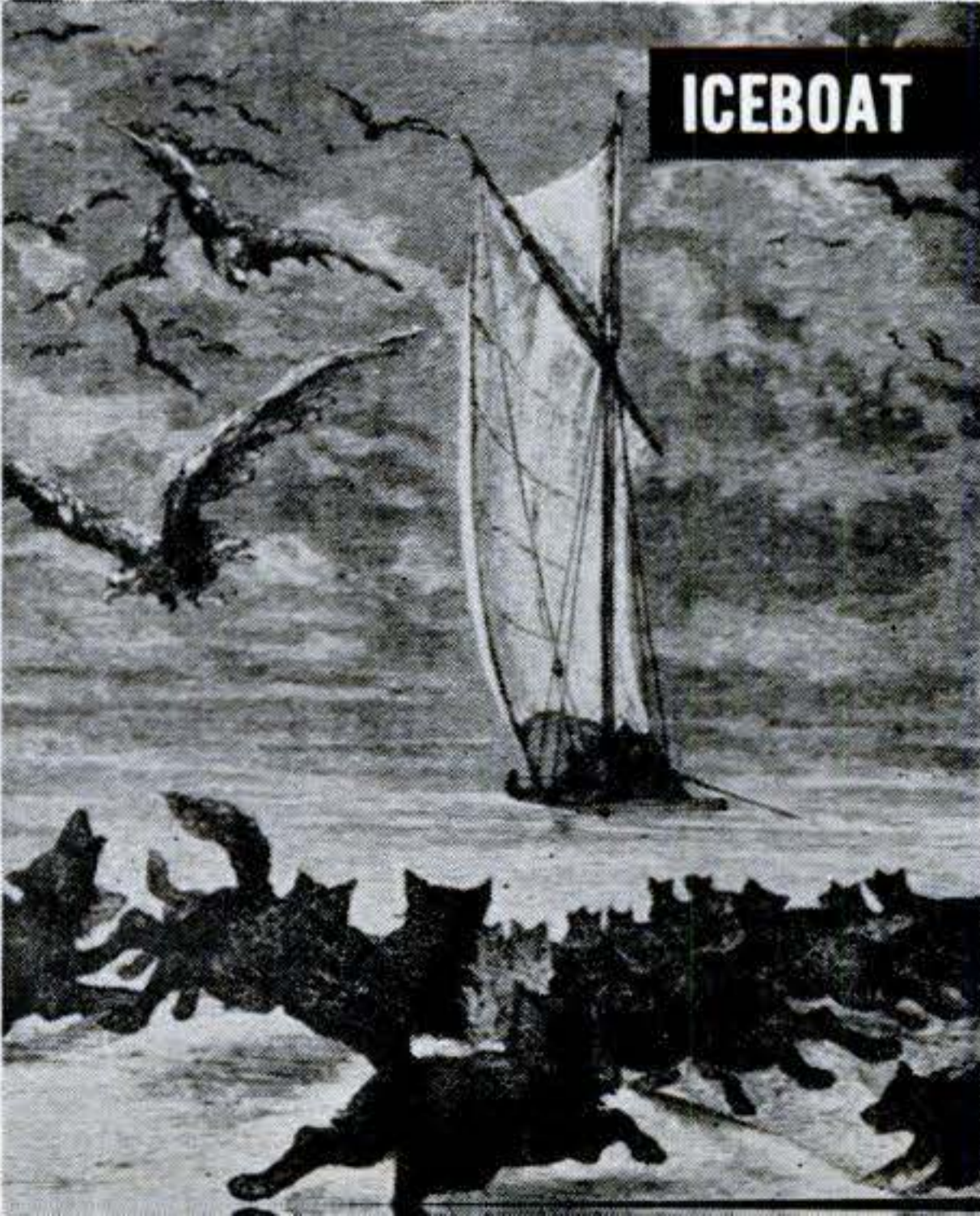

ICEBOAT

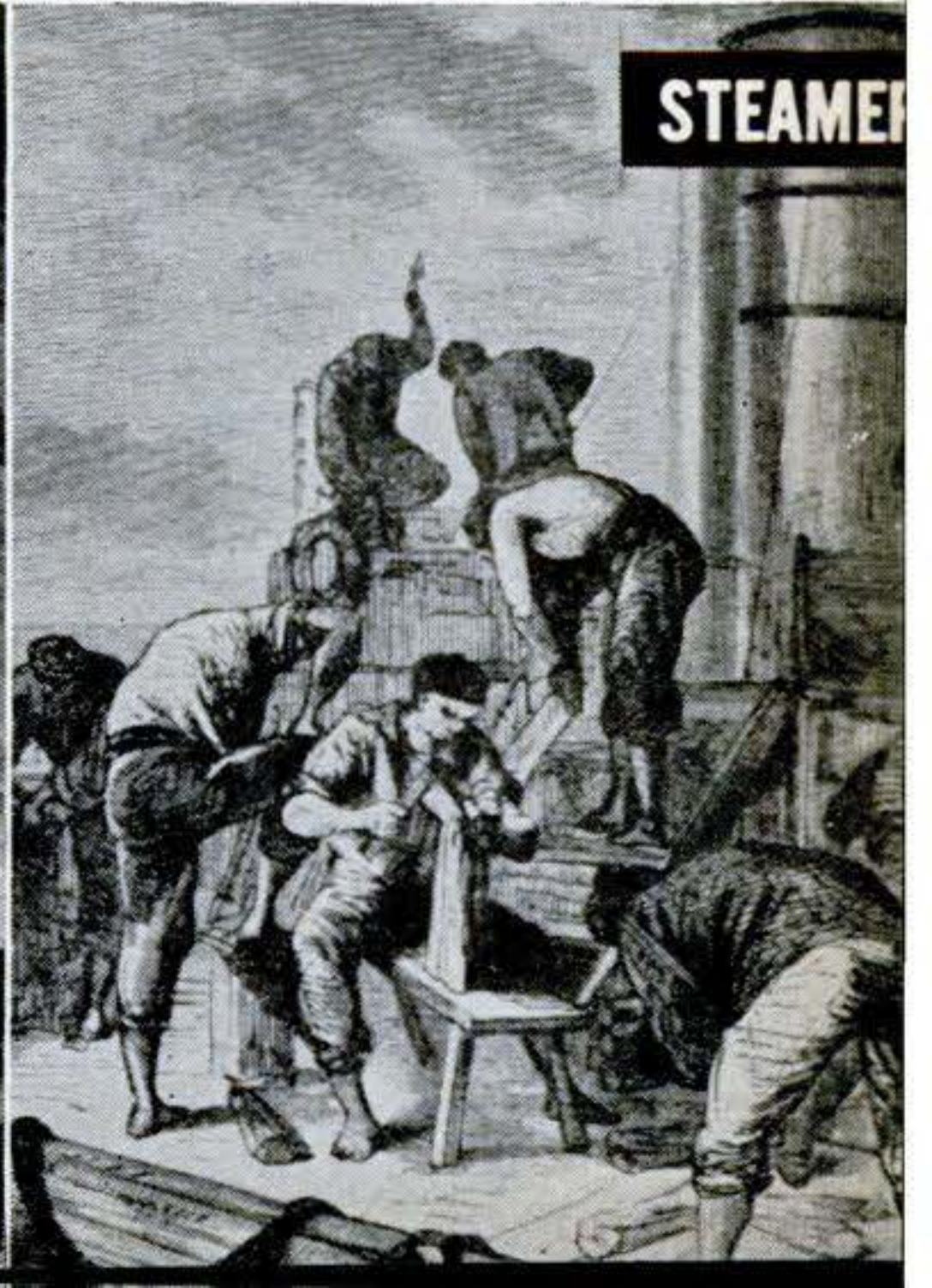

STEAMER

This is the 80th anniversary of Mr. Phileas Fogg's fast, fictitious trip around the world in 80 (or 81) days.

By Willy Ley



How the World Is Shrinking

JUST 80 years ago, a novel appeared in Paris that caught the imagination of the public and has held it ever since. *Around the World in Eighty Days* was born of the same bubbling interest in science and technology that led to the birth of POPULAR SCIENCE that same year, 1872. Jules Verne's classic pitted man against time—and the race still goes on.

Remember the story? Phlegmatic Phileas Fogg bet \$100,000 that he could go around the world in the then fantastic time of 80 days. He proposed to go 5,350 miles from London to Bombay via Suez in 20 days by rail and steamer; then 1,150 miles by rail to Calcutta in three days; 3,800 miles to Hong Kong by steamer in 13 days; 7,100 miles by ship to San Francisco via Yokohama in 28 days; 3,200 miles to New York in seven days; and 3,700 miles to London by steamer and rail in nine days.

But railways were found unfinished and steamers sailed ahead of schedule; an elephant had to be bought, Indians fought off. Fogg made it—but only because he gained a calendar day traveling across the international date line.

How fast could Mr. Fogg do it now? Turn the page and see. ➔

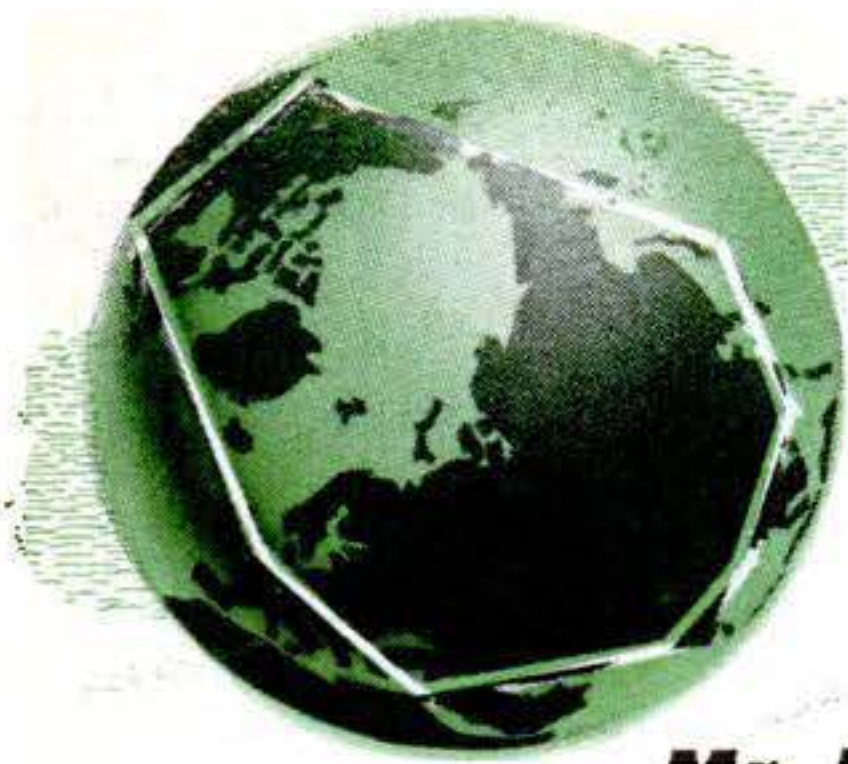

**Mr. Fogg's trip
could be made
in two days now.**

PHILEAS FOGG'S imaginary record stood unbroken for 17 years—then people started smashing it and have kept on ever since. Today, of course, anyone who wants to get around our little planet in a hurry goes by air—and the present record actually totals fewer hours than Phileas took days.

But the late Bill Odom, who made the trip all by himself in 73 hours and five minutes in 1947, flew his converted A-26 bomber only 19,645 miles, considerably less than the full trip around at the equator.

The record for the full distance—or close to it—is held by the Lucky Lady II, an Air Force B-50 bomber that was the first plane to fly around the world without stopping. In 1949, the Lady flew eastward from Fort Worth to Fort Worth in three days, 22 hours and one minute, making an average speed of 249 miles an hour. To do this she was

refueled in the air at four points along her 23,452-mile course—the Azores, Saudi Arabia, the Philippines and Hawaii.

Just this month, however, there's a plane going into service that—on the same basis—could cut the Lady's record in half. The new jet-propelled Comets that British Overseas Airways is putting on the England-India run have a 560-mile-an-hour top speed and cruise at 500. Their drawback is rapid fuel consumption, but if refueled repeatedly in the air a Comet could theoretically make the 24,000-mile circuit in just 48 hours.

Lanphier Holds Record

If like Mr. Fogg, however, you want to try to go around the world in commercial carriers, this nonstop technique will be of no help.

How long would it take you by regular air lines? Well, the record for circling the globe by scheduled commercial planes is four days, 23 hours and 47 minutes, set late in 1949 by Tom Lanphier of the Air Force Association. He covered 22,180 miles on a route very close to Fogg's—London, Syria, India, Hong Kong, Tokyo, San Francisco and back to New York. From New York to Hawaii, he traveled on Pan American Clippers, the rest of the way by United Air Lines and American Airlines.

Lanphier actually spent only 83 hours in the air: the rest of the time he waited on the



LUCKY LADY II, title holder for full round-the-world course, made trip nonstop. She was

refueled four times, as shown above. The Air Force Superfort carried crew of 14.

ground. Since layover time has since increased instead of decreased it would be difficult for you to match Lanphier's time today. Pan American, for example, has increased the number of stops, so that flying around the world in its planes now takes at least five days, 22 hours. That's going via Manila. If you follow the Fogg-Lanphier route via Tokyo, the Pan-Am trip will take you a day and a half longer. The "excursion fare" for the complete Pan-Am trip, incidentally, is \$1,700—\$200 less in the off season.

Swapping from one line to another, you make about the same time—unless you're a VIP and can get them to hold planes for you where schedules miss connection. In that case you can make the trip in close to five days.

One Obstacle Still Exists

Air travel has shrunk the globe-circling time, but you still face one obstacle that also confronted Jules Verne's hero 80 years ago. In 1872 Fogg had to circle around through India instead of going across Russia because the trans-Siberian railway had not yet been built. Now you have to circle via India to avoid cracking your head against the Iron Curtain.

How fast will men go 80 years from now—in 2032? Turn the page and see. ➔



FASTEST GLOBE-CIRCLING TRIP was made by Bill Odom in 1947, but he went 5,000 miles less than full equatorial distance. He spent 63 hours, 15 minutes in the air.



TOM LANPHIER HOLDS RECORD for trip by commercial carriers. Above, he checks in with customs at Delhi, India, where he was 16 minutes ahead of his schedule for that leg.



JET-PROPELLED COMET, which British Overseas Airways is putting into service between Eng-

land and Asia, broke London-Karachi record by three hours, 10 minutes on trial run.



**Mr. Fogg's trip
will take only
two hours in 2032.**

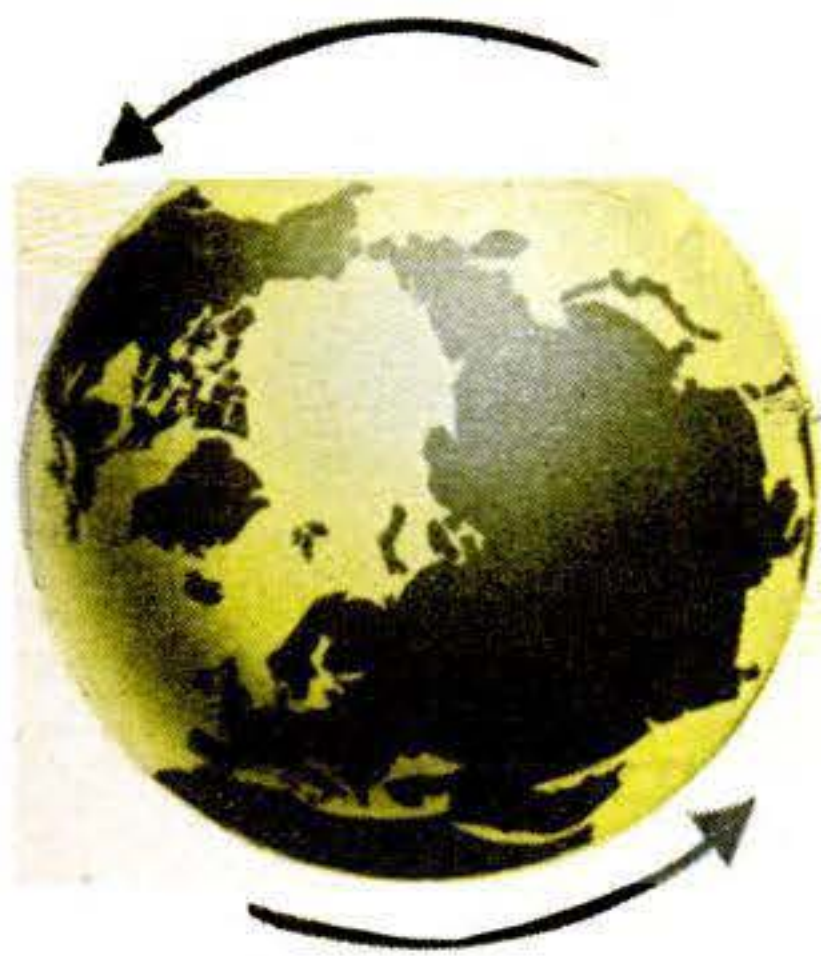

WITHIN 80 years some people will be going around the world 12 times a day, every day in the year. Sound like a fantastic stunt? Not for these boys. Their nonstop globe girdling will be strictly in line of duty—manning a space station (PS, Oct. '51, p. 120) that will circle the world as endlessly as the moon.

The space station won't, of course, come into being all at once. An in-between step will be passenger-carrying rockets—in fact, plans now exist for such a rocket capable of completing the San Francisco-New York hop in an hour. Rockets will go into general service as we learn more about their design.

Speed Depends on Gravity

And from the information the rockets give us about the upper stratosphere and ionosphere will come data needed to design space stations. Just how fast these artificial satellites will “circumnavigate” the globe will depend on how far out in space they are. The station must go fast enough to make its centrifugal force balance the pull of gravity at its distance from the earth.

Since gravity decreases with distance, the farther the station is from the earth, the slower it will be able to go.

At the 350-mile level, it would have to move 4.7 miles a second to stay aloft, making the circuit trip in 96 minutes. But at a height of 1,037 miles it would go 4.4 miles a second and the circuit would take just two hours. And 22,300 miles out it would travel “only” about two miles a second and would need 24 hours to go around once.

The main purpose of a space station will

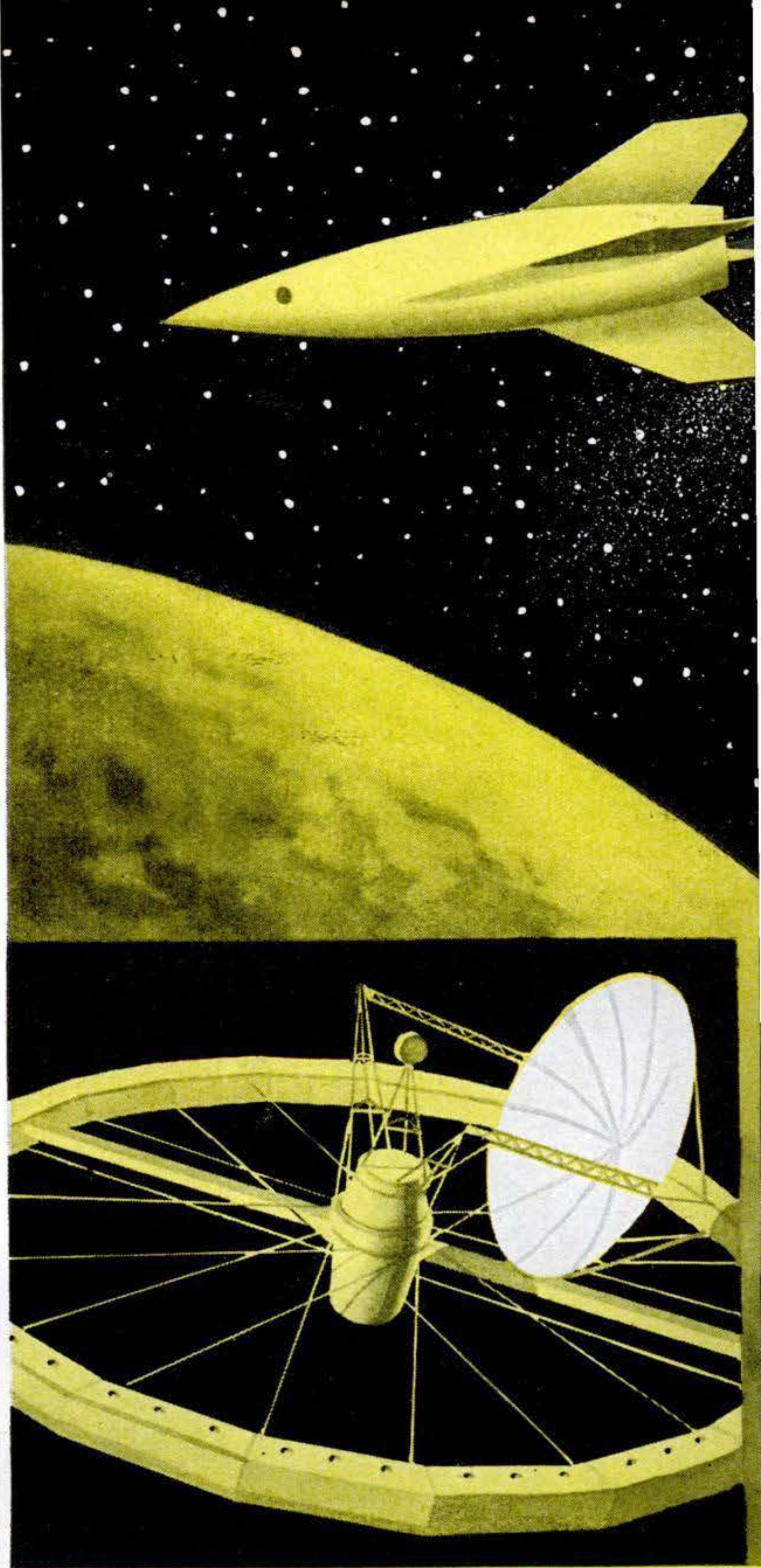

SPACE STATION will start as bicycle-wheel structure (inset) then be elaborated to mini-

be to serve as a refueling base for space craft on long voyages. On a trip to the moon, for example, most of a ship's fuel will be needed just to take off. But at the space station the captain can fill his tanks again. And when he takes off this time, he will not only be above the atmosphere and have less gravitational pull to overcome, but he will get a healthy start from the velocity of the station.

The station will be useful in other ways, too. Besides making a wonderful observatory



ature satellite. Space ships will nose in to outer ring to refuel. Observatories, labs,

for study of both the earth and the heavens, it will be a better research lab than any on earth. You need a perfect vacuum for an experiment? Pick an outside room, put on a space suit and unscrew the window. You need extreme heat? Simply concentrate the sun's rays on your specimen with a parabolic mirror: it will soon be vaporized. Or you want to cool something down near absolute zero? Put it into the shadow of the station and keep it there.

fuel tanks, repair shops and living quarters will be housed in central sphere.

Since there will be no apparent gravity on the station, biologists will be able to find out just how much gravity influences growth. Does an amoeba split in two because it has reached a certain state, or simply because it is getting too heavy?

And finally, the space station can serve as a short-wave and television transmitter doing the job of hundreds of ground relay stations. That application will save money—and may help to get the station built. END

Aids to Modern Living



Cedar Paint. Now you can paint a cedar lining on closet walls. Water added to this pulverized cedar wood makes a moth-repelling liquid that can be brushed or sprayed. *Cedar-Lux Products Co., Kansas City, Mo.*



5-in-1 Drier. This clothes drier serves as a hamper between washdays. Raise the top, add a shield and it's a room heater or hair drier. Turn off heater and fan cools room. *Nat'l. Eng. & Mfg. Co., Kansas City, Mo.*

Nut Chopper. When the crank of the grinder below is turned, nut meats fed into the hopper fall through to the bowl in bits and pieces. *The Washburn Co., Worcester, Mass.*

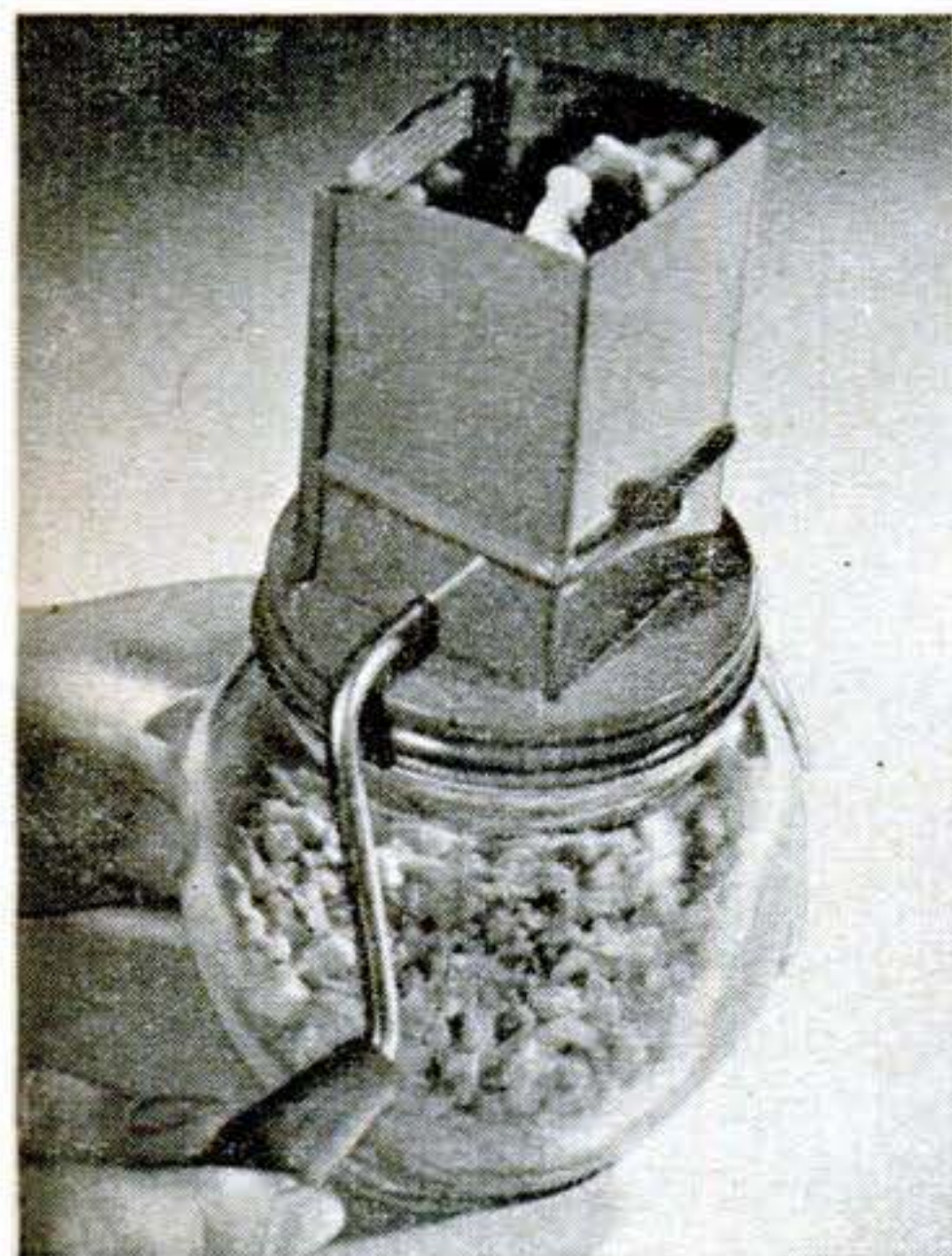

Shade Mop. This Venetian-blind washer carries its own cleaning fluid in a built-in reservoir. It comes with a quart of liquid for refilling. *Nu-Designs Co., Kalamazoo, Mich.*

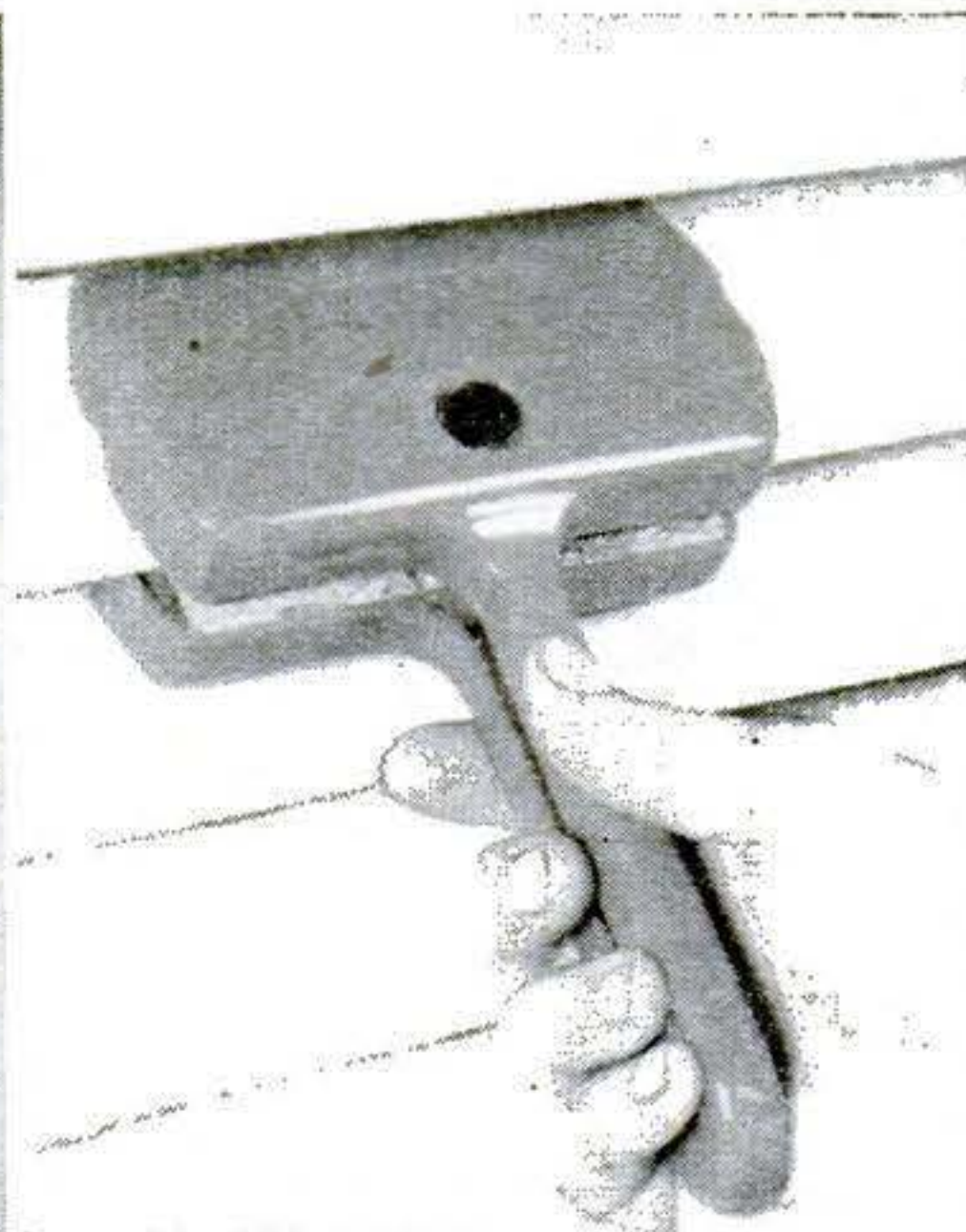

Room Drier. Damp basements can be kept comfortably dry with a dehumidifier that plugs into any 115-volt outlet. It also filters the air. *Frigidaire Division, Dayton, Ohio.*

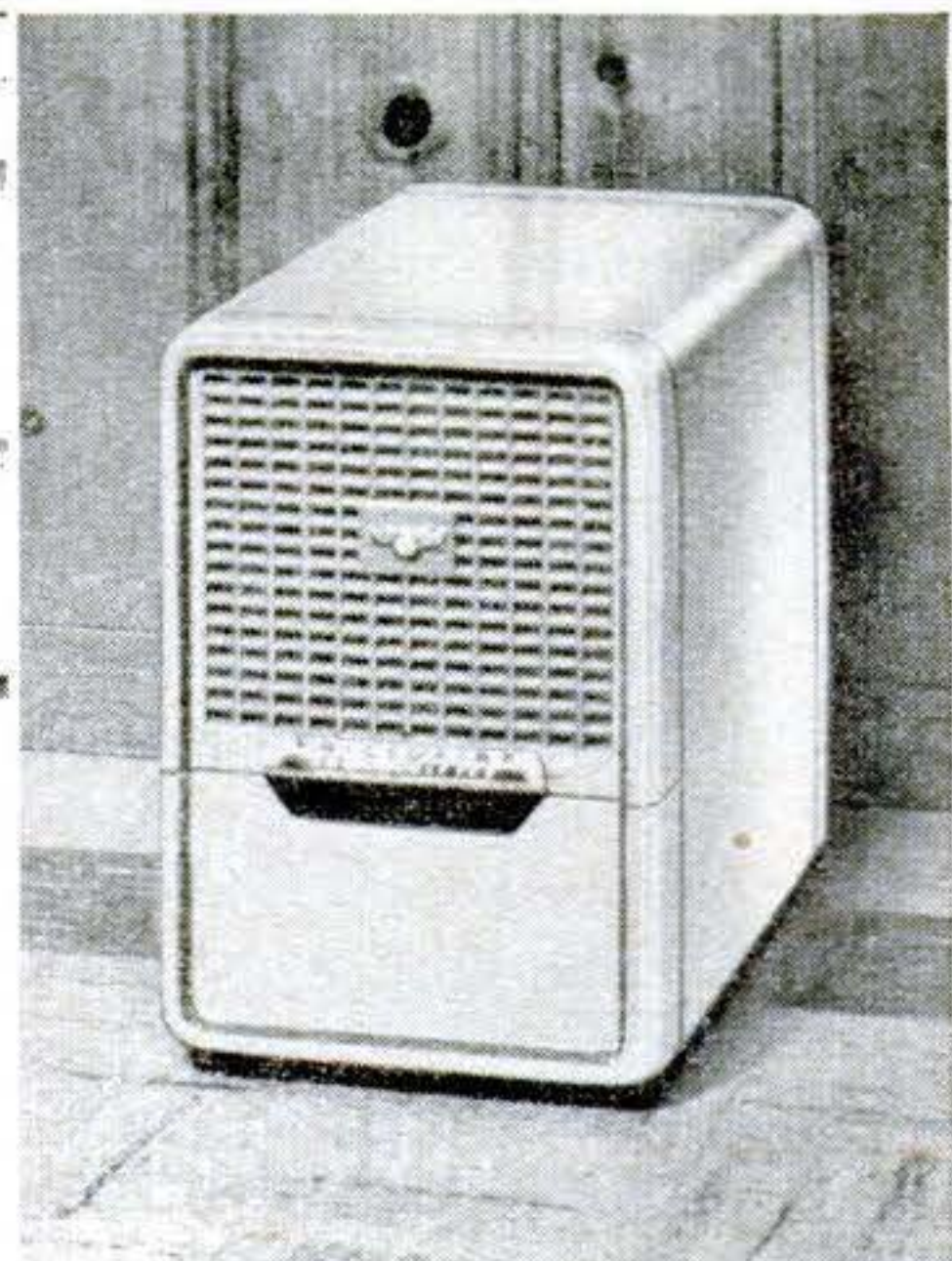

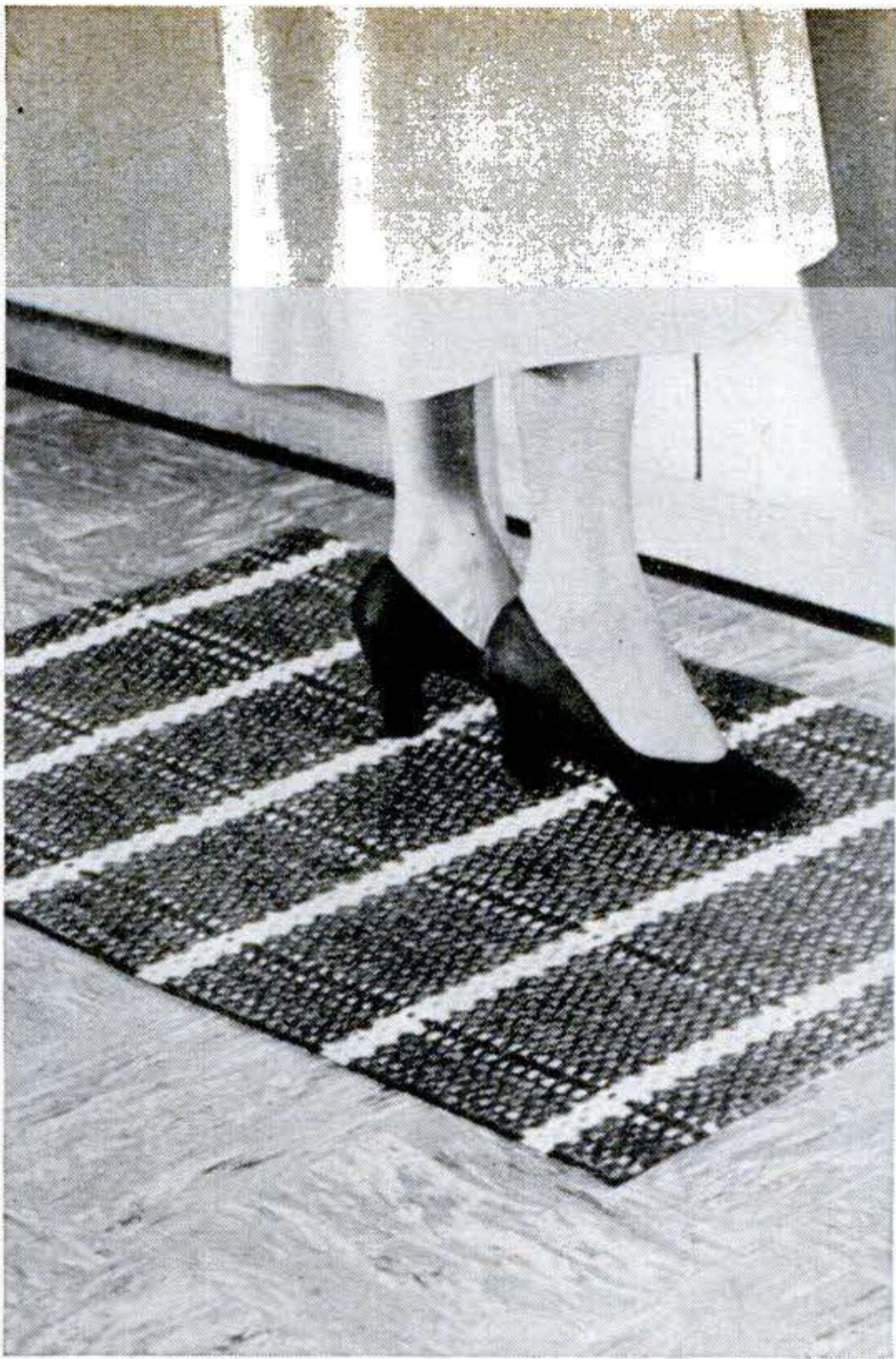

Washable Rugs. Reversible, nonskid rugs like the one shown here are made from interwoven plastic strips. They're said to resist scuffing, staining and tearing, and come in six sizes. *Susquehanna Mills, Inc., New York.*

Thread Holder. A ball of knitting yarn or crochet thread unwinds smoothly without knots or snarls when mounted on the plastic turntable below. *O. L. Phillips Co., Rockford, Ill.*



Umbrella Light. A flashlight in this umbrella handle will light up puddles on stormy nights. A twist of the handle and a lock ring turns light on or off. *Ruth Cooper, N. Y. C.*

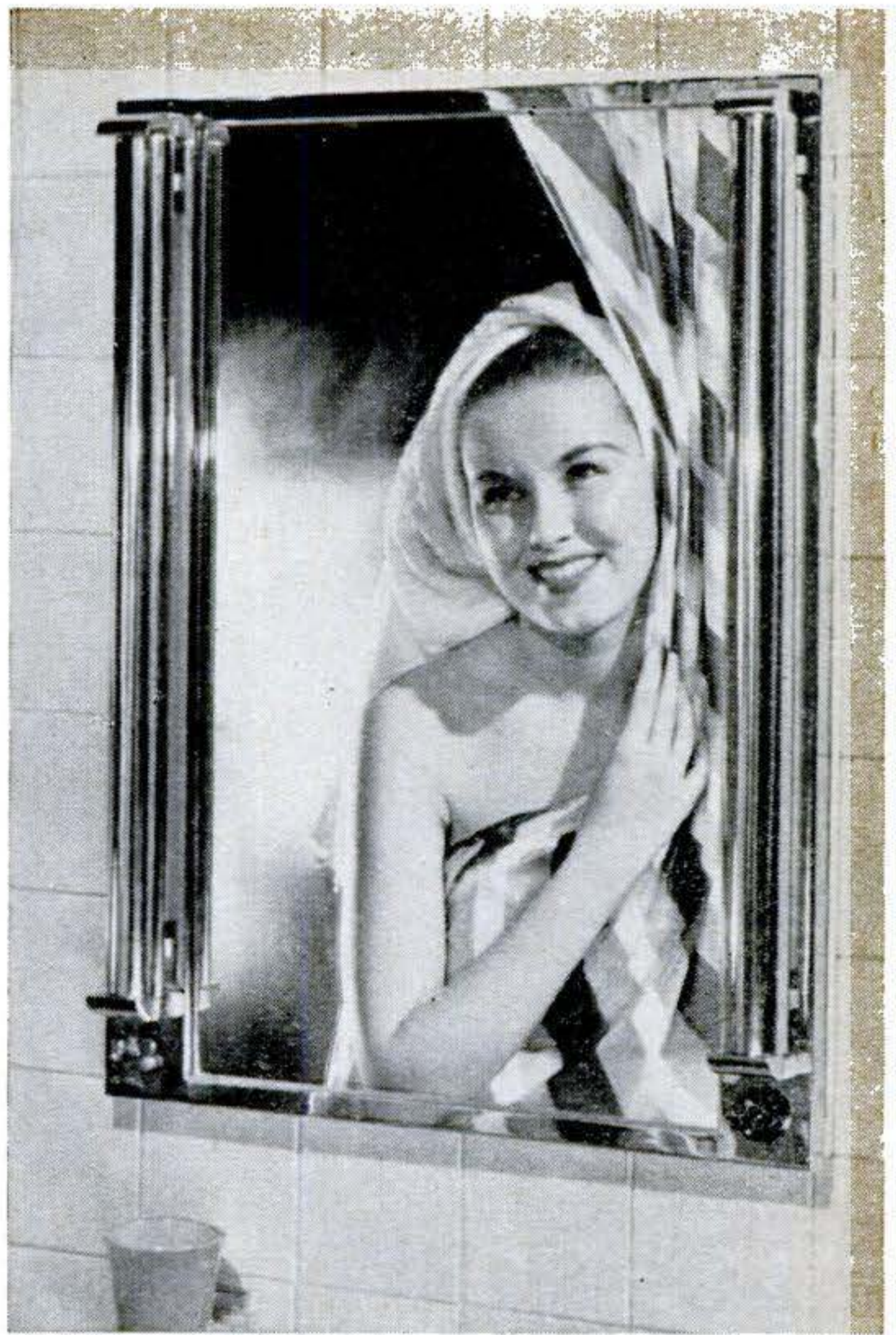
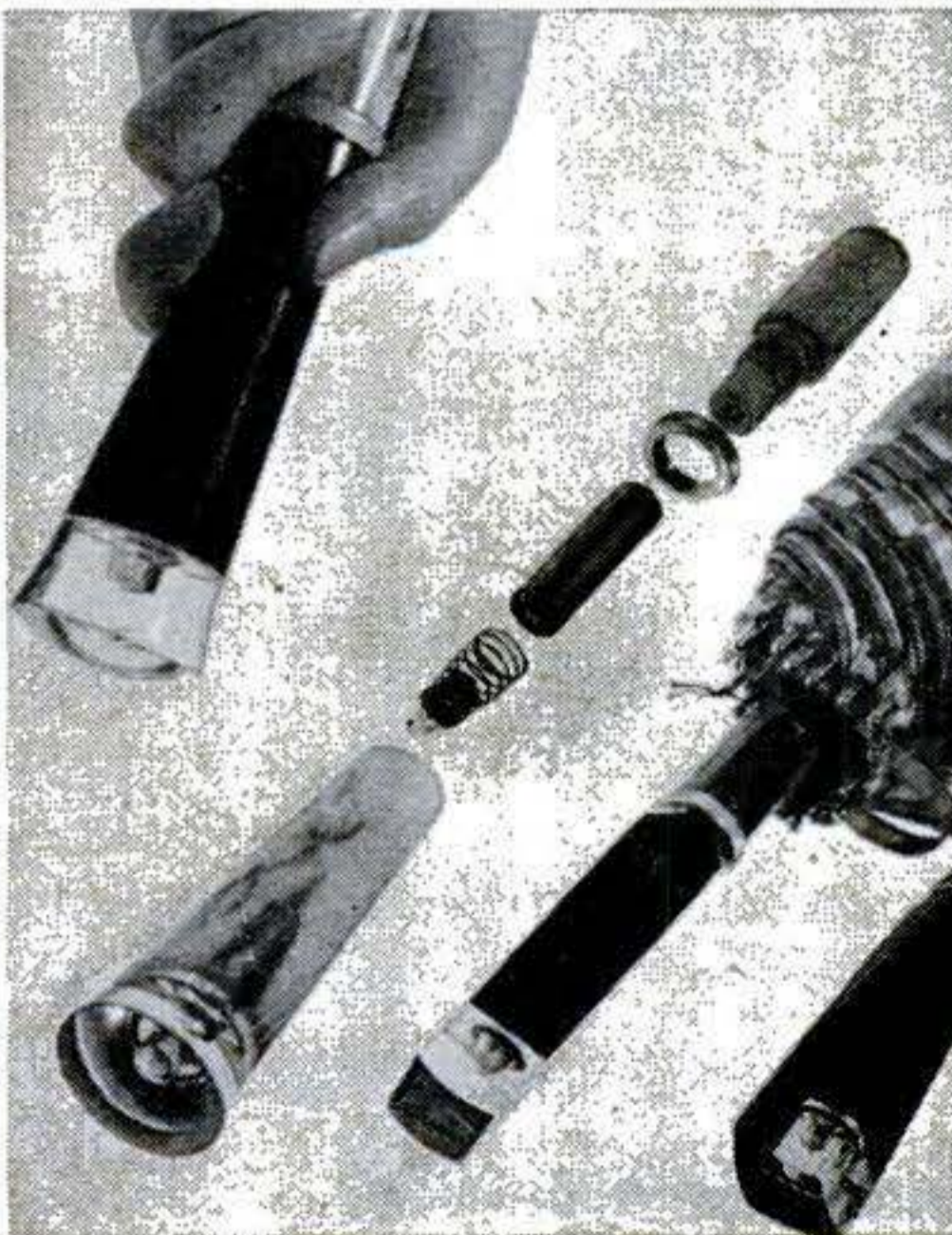

No-Fog Mirror. If hot water from the shower steams up this medicine-cabinet mirror, just press a button. An electric heater behind the glass clears it and keeps it free of fog. *Charles Parker Co., Meriden, Conn.*

Self-Watering Pot. This plant needs watering only once a week. A wick carries water from the base of the pot to the plant roots by capillary action. *Quality Molding Co., Chicago.*



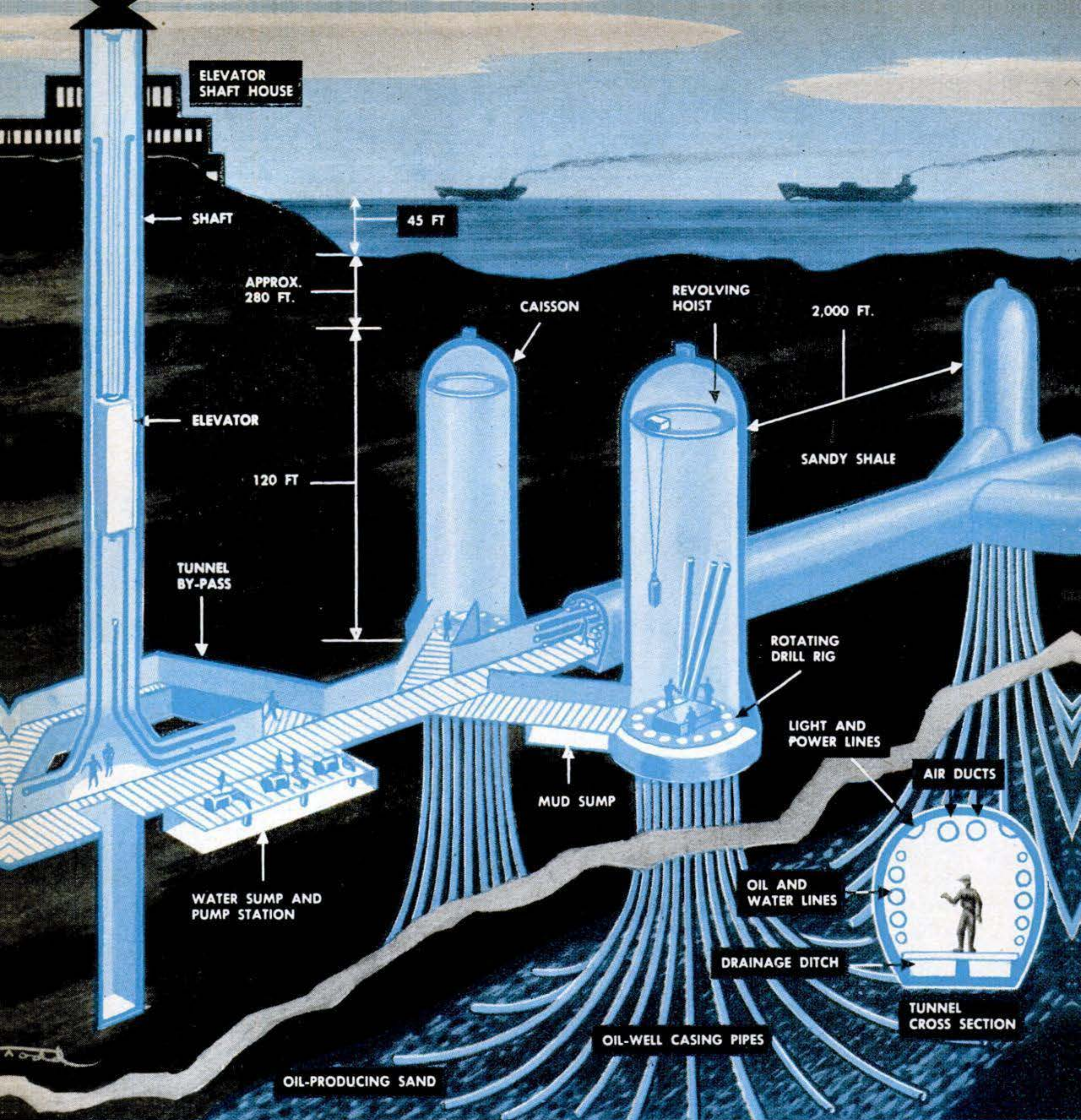

Tunnels to Tap Undersea Oil

HOW do you get at forty billion gallons of oil hundreds of feet below the sea without blocking a busy harbor?

That was the \$100,000,000,000 question—the approximate value of oil under the ocean near Long Beach, Calif.—until engineer-geologist Hillman A. Hansen came up with the proposal shown above.

The plan envisions a vertical shaft on

shore. From its bottom, a network of tunnels would be dug out under the water, about 400 feet below the sea bottom.

At the ends of the tunnels, caissons would be constructed to give working space, full-size drill rigs would be brought in, and the digging would start from there. A number of wells would be sunk from each caisson, fanning out in a circular pattern. By whipstocking—slanting the drill—each well could be placed exactly where desired. Twenty wells from a caisson would serve 100 acres of the sub-sea oil field.

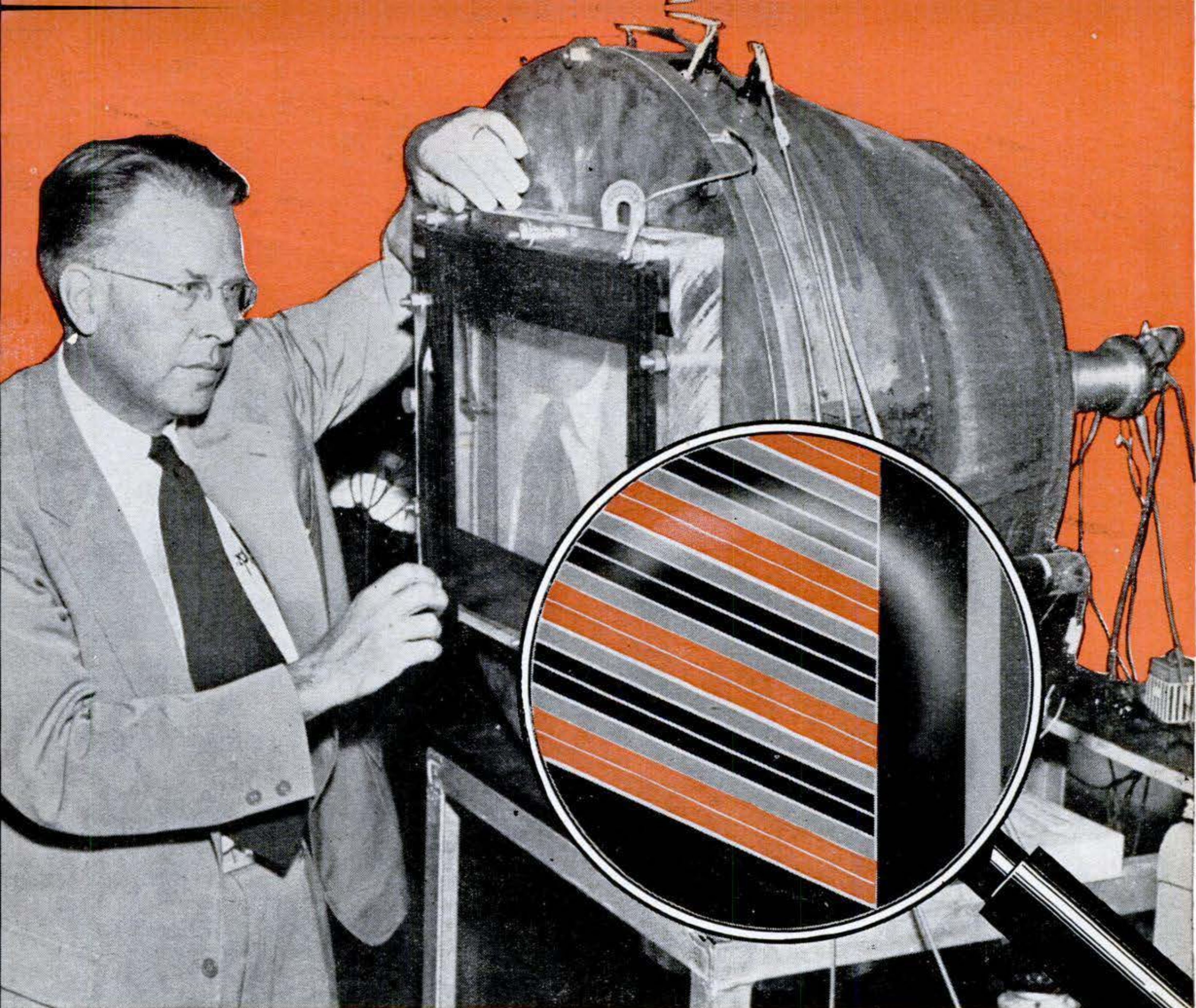

HOMEMADE MODEL of tricolor tube developed by Dr. Ernest O. Lawrence contains such unorthodox parts as spark plugs, pipe fittings and horseshoe magnets — but it works.

Enlarged section shows how red, green and blue color phosphors are arranged in parallel lines on picture screen.

Scientist Invents Simple Color-TV Tube

Product of atom expert's home shop can work with any color-television system.

By Darrell Huff

A HOME-WORKSHOP enthusiast of Diablo, Calif., has invented a new television tube that may help end the wrangle over color TV.

Working in his spare time, Dr. Ernest O. Lawrence—the man who invented the cyclotron and who now directs the University of California Radiation Laboratory—has come up with an all-purpose TV viewing tube

simpler than others developed until now.

Tune in a color-TV program, and it gives tricolor pictures. It will work with any of the several color-TV systems proposed and with black-and-white television as well. And, say its sponsors, it can be mass-produced at a cost little greater than that of today's black-and-white tubes.

The thing began in a converted garage. Dr. Lawrence, who built the first atom-smashing cyclotron before he was 30, pro-

PARALLEL STRIPS OF COLOR PHOSPHORS ARE ARRANGED ON SCREEN IN THE ORDER SHOWN (R STANDS FOR RED; G, GREEN; B, BLUE)

CHARGED WIRES OF GRID RUN PARALLEL TO PHOSPHOR STRIPS

BEAM MOVEMENT FOR SCANNING IS PRODUCED BY STANDARD FITTINGS (OMITTED FOR SIMPLICITY)

ELECTRON BEAM TAKES ALTERNATE PATHS, AND PRODUCES DIFFERENT COLORS ON SCREEN, ACCORDING TO CHARGES ON WIRES OF GRID

VAPORIZED-ALUMINUM BACKING IS THIN ENOUGH TO BE PENETRATED BY ELECTRONS

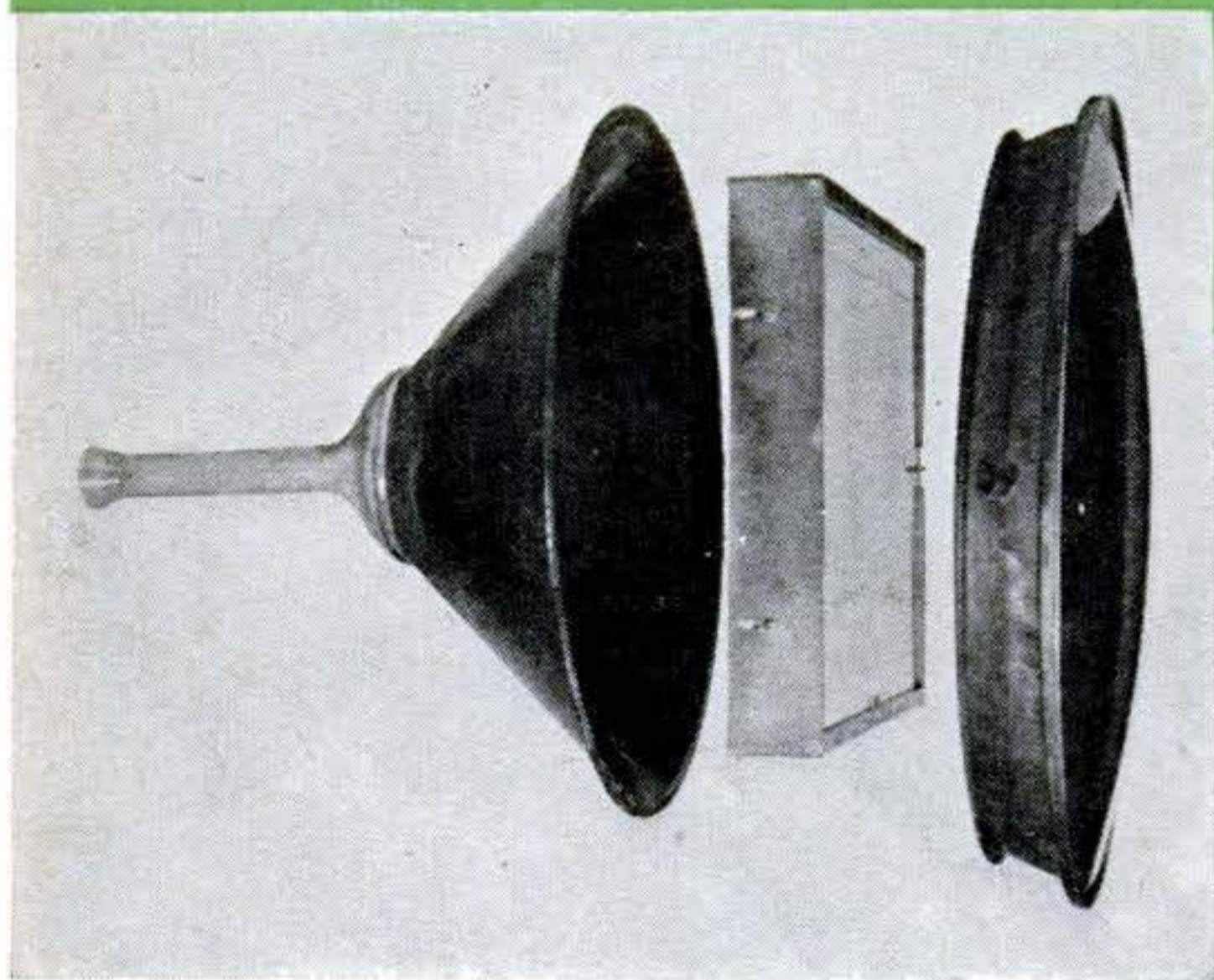

HOW IT WORKS. Simplified diagram of Lawrence tube (above) shows path of beam through grid of charged wires to screen. Grid lets beam pass unaffected (solid line) or deflects it upward or downward (dotted lines) so that it strikes phosphor strip of desired color. Diagram exaggerates width of phosphor strips. Screens of experimental tubes actually had 400 green strips and 200 each (double-width) of red and blue. Photo (left) shows cone, grid-and-screen block, and glass cover of "pilot" commercial model.

duces many ideas beyond those fitting into his work as an atomic scientist. To have a place to work them out in his spare time, he bought a small house an hour's drive from his Berkeley home, and turned the double garage into a hobby shop. He equipped it with lathe, drill press, tool grinder, horizontal mill, bandsaw, belt sander—and, electrons being his business, an oscilloscope and a signal generator.

Children's Questions Started It

One thing that emerged from the home workshop was a device for sharpening television images. Then, stimulated by his children's questions—which inspired others of his own—he tackled the problems of color TV.

In a TV tube, an electron gun sprays a thin stream of electrons, like a beam from a searchlight. They are invisible, but they produce a glow when they strike phosphors forming the chemical coating of the viewing screen. The picture you see consists of

luminous points, produced as the flickering beam moves rapidly across the plate in a straight line, then in another slightly below it, and so on. Color TV requires doing this in three stages—once each for red, green and blue. Your eye merges the images of each color into a complete natural-color picture.

Suppose, reasoned Dr. Lawrence, you start with a black-and-white tube. First, chop off the viewing end. In its place, put a grid of fine parallel wires that can be charged positively or negatively. Beyond the grid, mount a screen bearing strips of phosphors that glow in the three primary colors.

Now, if you charge two adjacent wires of the grid negatively, they will both repel the beam from the electron gun—because electrons are negative. The beam will go straight through, between the wires, and strike the phosphor that glows green.

If you charge one wire positively and the next one negatively, the beam will

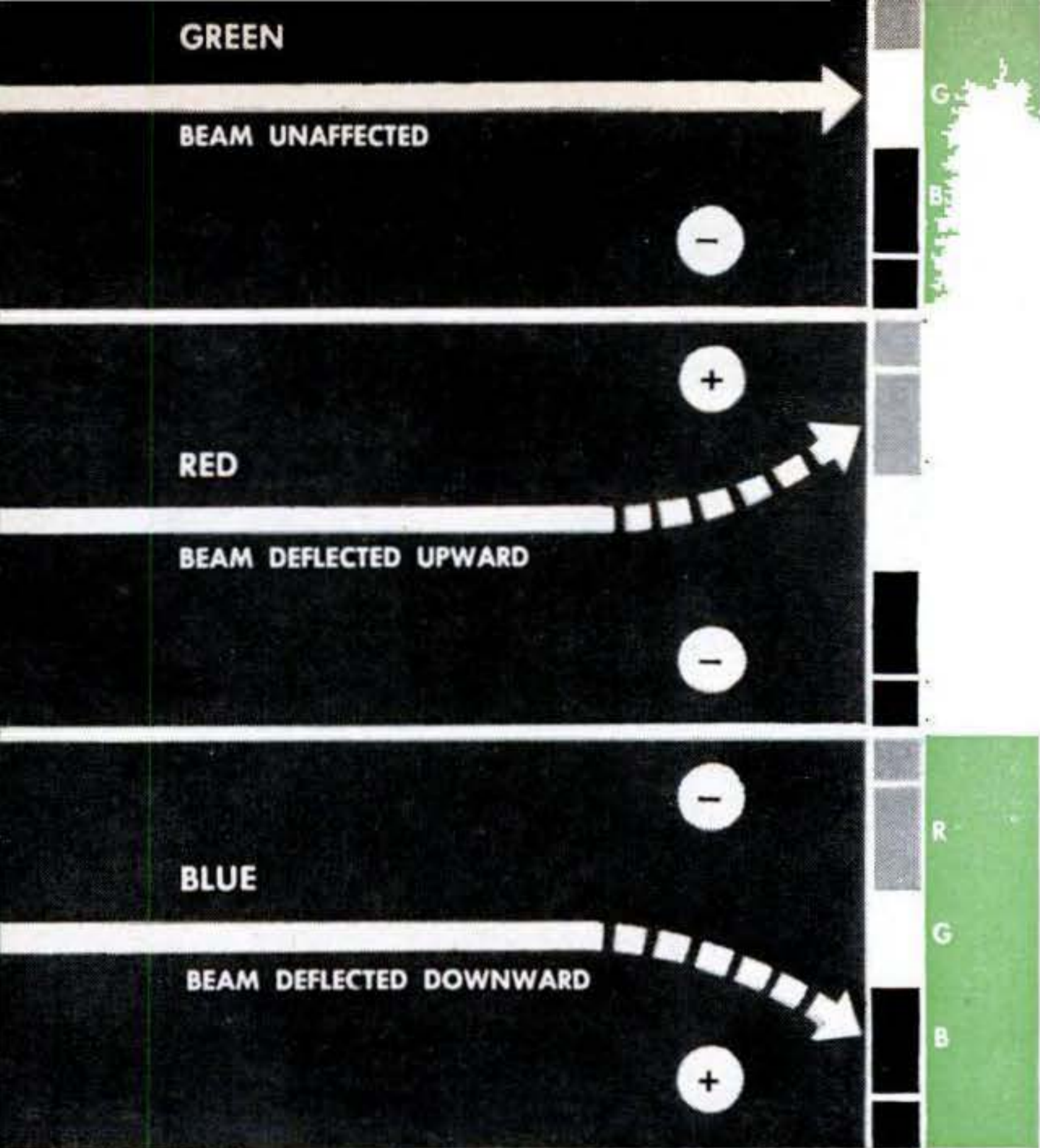

GREEN, RED AND BLUE are produced by varying charges on grid wires as above. Negatively charged electrons of beam are repelled by a negative wire, attracted by a positive one.

be deflected toward the positive wire. It will strike the phosphor that glows red.

Finally, reversing the charges will deflect the beam to the blue phosphor.

This new way of selecting colors in a tricolor-TV tube looked good to Dr. Lawrence. To get from theory to practice, he stocked his workshop with new tools and

equipment and tripled its area. Part-time workers were hired to speed the project.

The first crude model that Dr. Lawrence and associates put together bore little physical resemblance to a vacuum tube—a fact that will surprise no inventor or home mechanic.

Iron Works Made Body

From a pencil sketch on wrapping paper, an iron works made the body of the tube out of sheet iron. The front window was \$50 worth of two-inch-thick Lucite plastic. Ordinary auto spark plugs served as high-voltage fittings. Horseshoe magnets, stuck on here and there, counteracted magnetism of the steel body set up during welding. Pipe fittings such as plumbers use connected a gauge to measure vacuum maintained by pumping. Color phosphors were standard ones printed on the viewing screen by the silk-screen process.

When the makeshift model was demonstrated to experts in New York City last September, they judged color quality excellent. Some thought the image a bit grainy—for which the remedy, Dr. Lawrence explained, is increasing the number of wires in the grid. He also made it plain that a manufactured version will look nothing like the bulky homemade tube.

During the early stages of Lawrence's work on his tube, an organization was created to turn it into a commercial product

[\[Continued on page 252\]](#)

Tubes for Color Television? Here Are Five Other Kinds

THE MANY AVENUES to color TV now being explored are indicated by this RCA exhibit of five different experimental tricolor tubes. In rear row are "three-gun shadow-mask" tube

used in RCA field tests (left) and "line-screen" tube; in front row (left to right) are "grid-controlled," "one-gun shadow-mask" and "45-degree reflection" tubes.



I'd like to see them make...

Everyone has his own pet idea of some gadget he would like to see in general use. What is YOURS? Popular Science will pay \$5.00 for each one published. Use government postcards only. Contributions cannot be acknowledged or returned.



TRIANGULAR TELEVISION AND RADIO CABINETS to fit in corners. Since sets are often placed there anyway, this would afford better furniture arrangement and, with TV, better viewing.—*Stephen Matovich, Portsmouth, Va.*

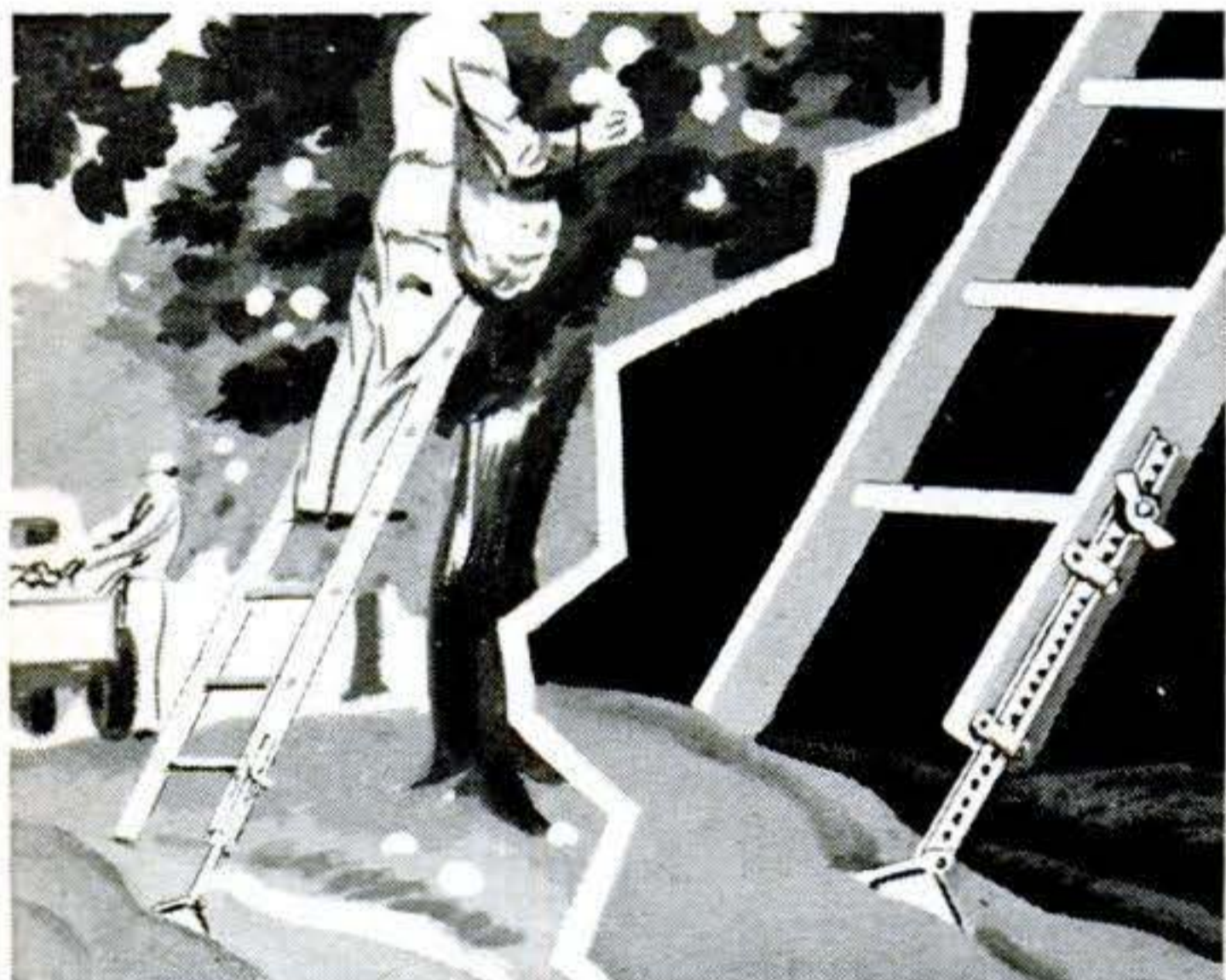

A LADDER WITH ONE ADJUSTABLE LEG so that it would stand level on uneven ground—for picking fruit, etc. Leg could be adjusted by means of a metal extension and thumbscrew.—*Warren Shepard, Syracuse, N. Y.*



AN AUTOMATIC CLOTHESLINE REWIND with a locking spring. With it, the line could be stored out of the way yet wouldn't sag when pulled out and fastened to another post for use.—*Maude Anderson, Media, Pa.*

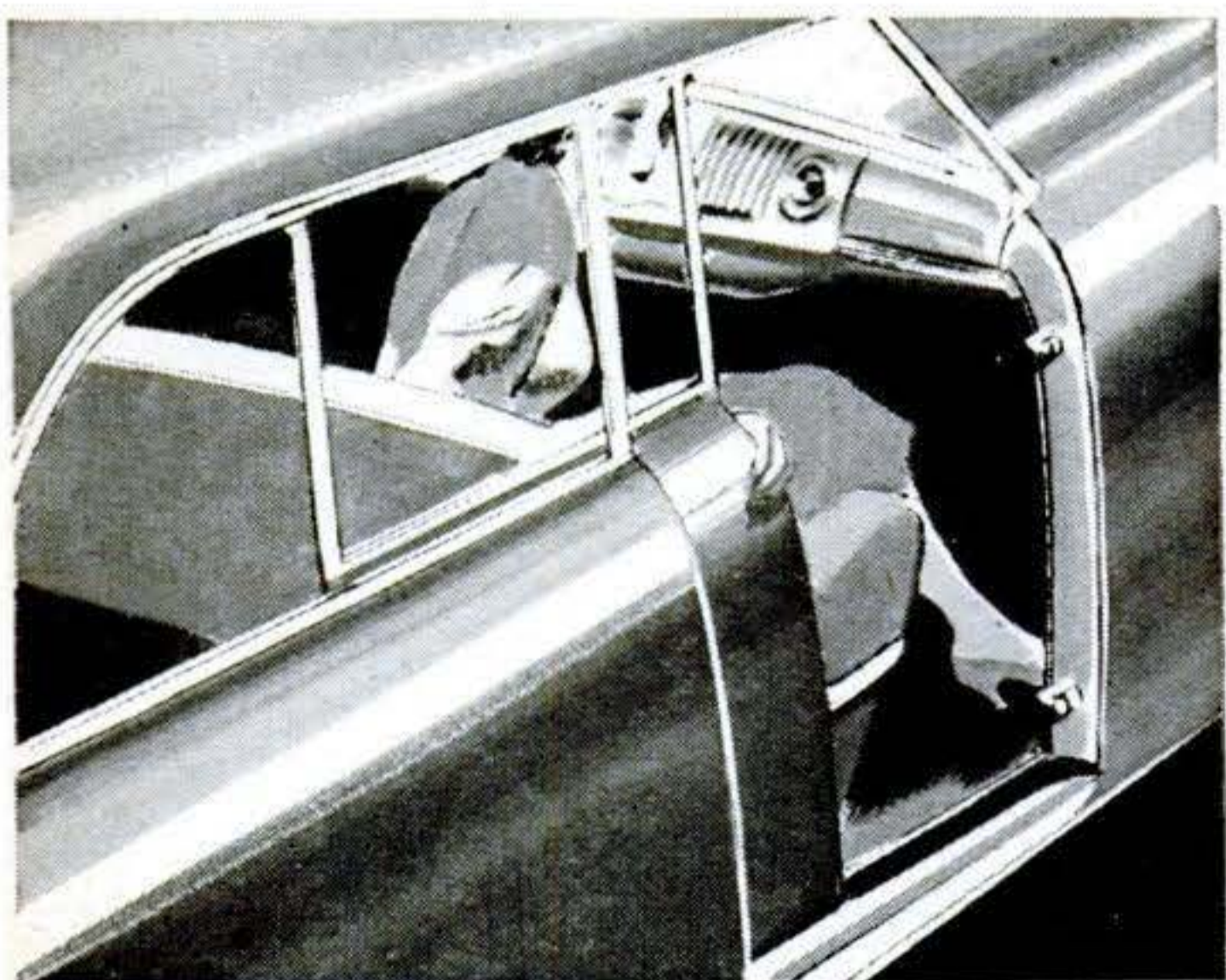

AUTOMOBILE DOORS WHICH WOULD SLIDE BACK instead of swinging out—to eliminate the hazard of a door's opening when car is in motion, and to save space when getting in and out of car.—*D. Hoffman, Pelham, N. Y.*



AN EXTRA, FALSE SCREW TOP on an auto-polish can. You could screw the lid on the extra top when using the polish and thus avoid the annoyance of losing or misplacing it.—*Dave Vonderahe, Torrance, Calif.*



Derrick Jumps into Action

BUILT to install heavy pumps and lift as much as 50 tons, this odd-looking portable derrick arrives at a job collapsed (above) but is quickly ready for work. The operator, seated behind the cab of the truck, flips it on its feet by means of a powerful hydraulic ram. The derrick's free leg swings to the ground, where it must be supported by jacks when the winch-controlled sheave tackle hooks onto a big load.

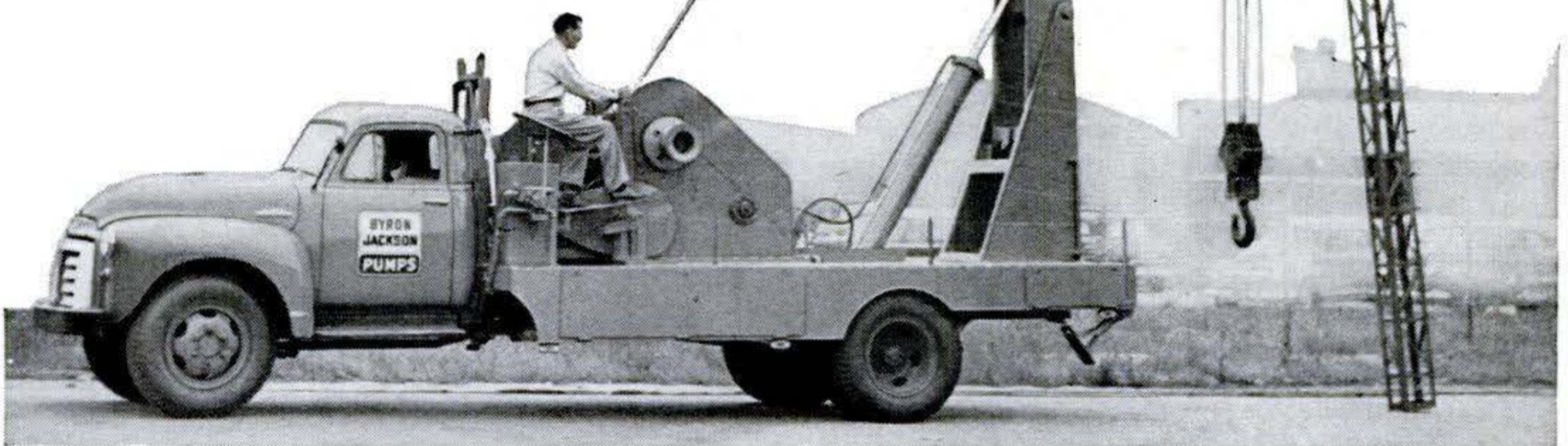

Plywood Makes Light Trailer

AS STRONG as steel, so its builders say, the new refrigerator truck-trailer above uses little of it. Instead the vehicle is made almost entirely of plastic-laminated plywood, molded in one piece, by Chicago's Pressed Steel Car Co. It is said to be lighter, roomier, better insulated, easier to maneuver, and rustless.

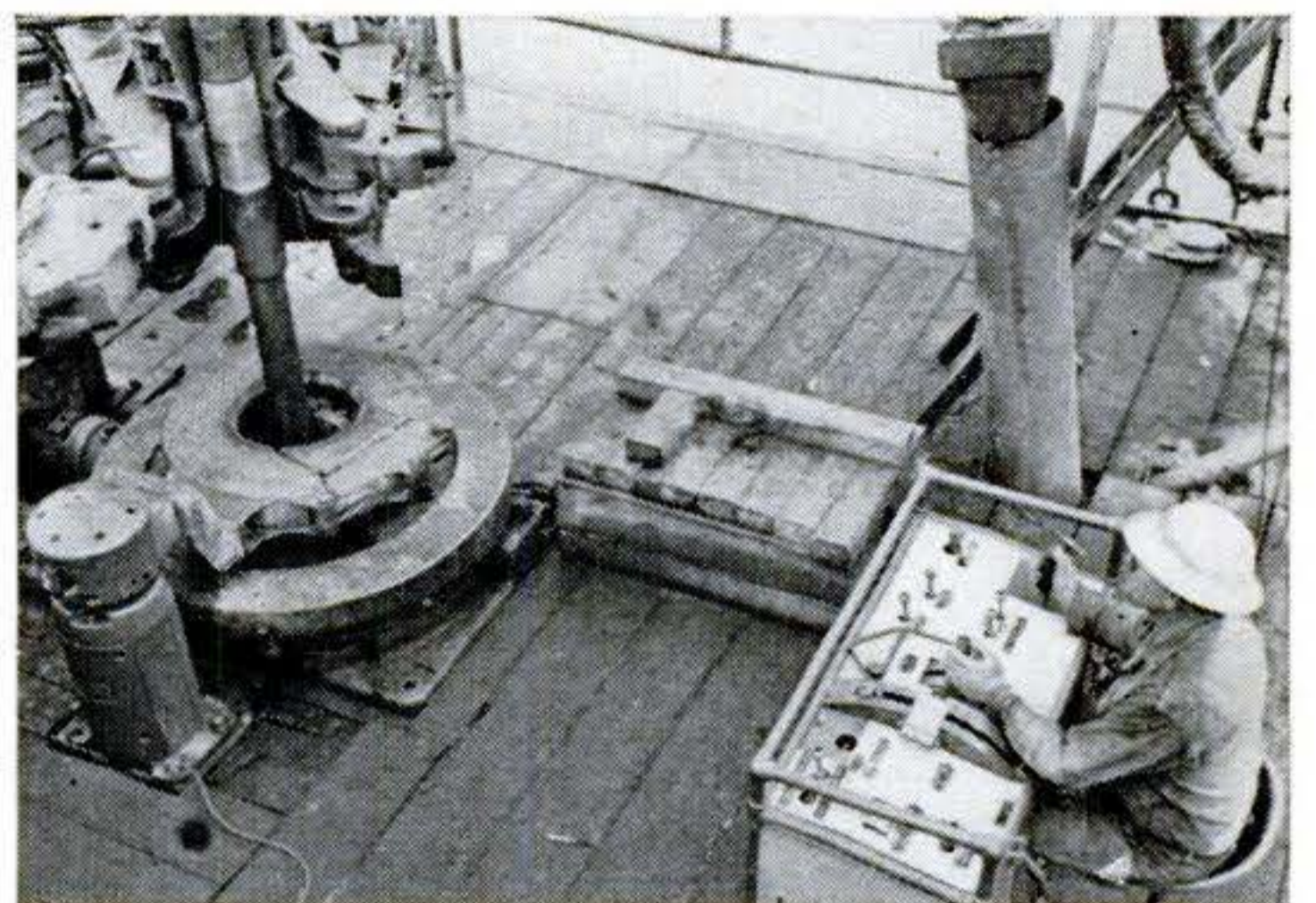

Robot Drills Oil Wells

STEEL hands and arms moved by compressed air and water may take oil drilling entirely out of human hands. With new equipment made by Byron Jackson Co., Los Angeles, a man at a panel controls power tongs (upper left) that hold and spin bit and pipe in and out of the hole. Derrickman stacks pipe, also with levers.



Loggers Invade African Jungle

Modern machines are bringing out rare, heavy, durable wood.

RARE African woods are not quite so rare any more. Thanks to Marshall Plan dollars, large untapped forests in the French Camerouns on the west coast of Africa are now being developed.

Logging these valuable woods used to be difficult and slow because only primitive native labor was available for working in the dense jungle undergrowth, and there were few roads. Rivers could not be used for transporting, either: this wood is so heavy it will not float. Shortly after World War II, however, American bulldozers began to fight their way through the thick vegetation to clear roads for dragging out the timber. Up-to-date sawmills were also erected.

Now 60 varieties of tropical woods are coming from Africa. One of the most useful is azobe, which comes from the Bongossi tree. A tough, durable hardwood, it weighs 60 to 70 pounds per cubic foot when seasoned. Because it resists decay it is used mainly to make underwater piling, bridges and railroad ties.

Photos on these pages show how rare-wood trees are cut down and processed by native lumberjacks and modern machines.



THIS MAMMOTH LOG, typical of the rare-wood timber growing in equatorial Africa, is thick-



er than the man standing on it is tall. Felled by natives and hauled out of dense forests by

American tractors, logs like this often weigh as much as 33 tons apiece.



TWO TRACTORS, one dragging and another pushing, are needed to move big logs out of the jungle to a clearing. The log hangs from a hoist attached to the tractor in foreground.

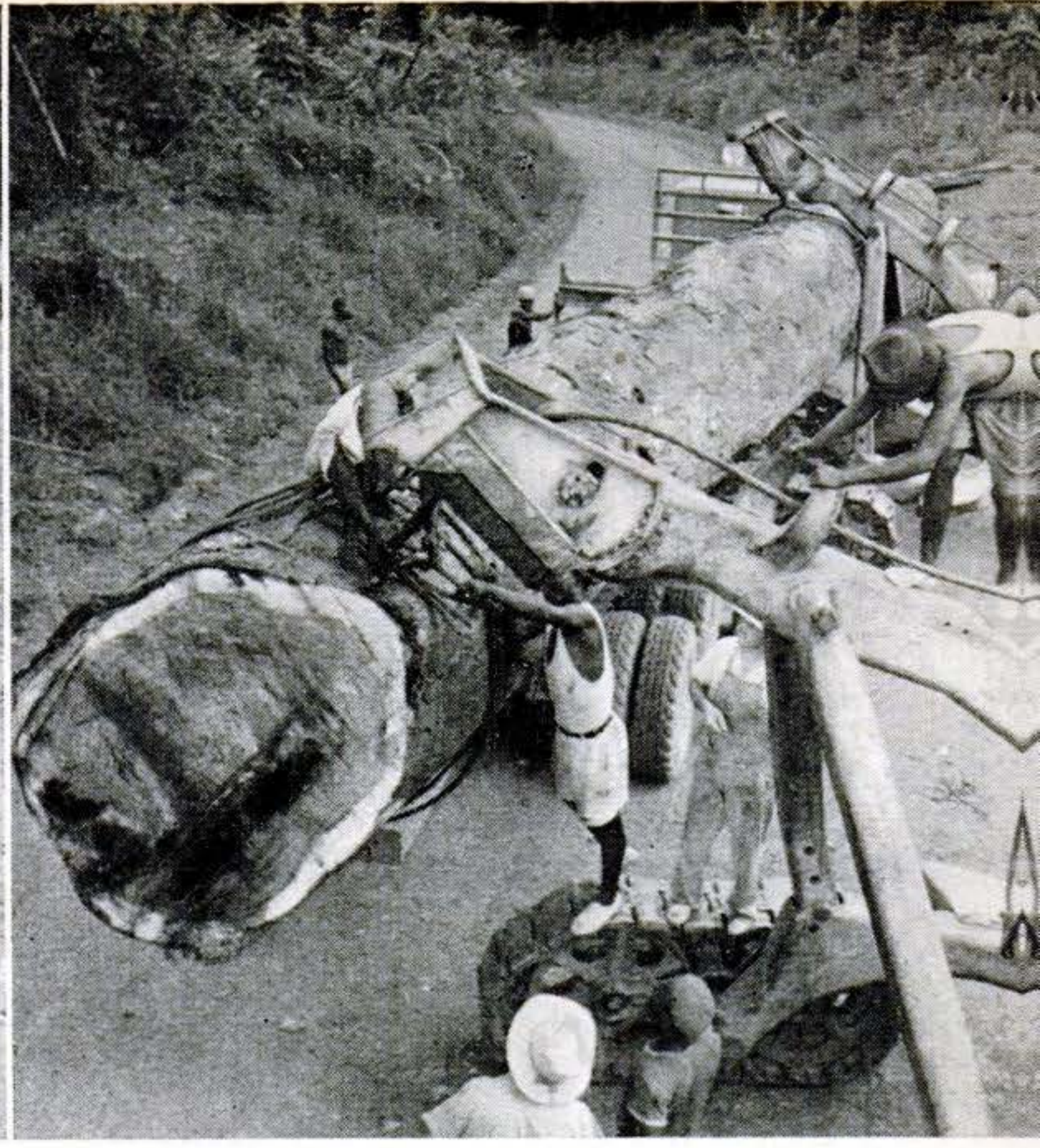

THE LOG IS LIFTED BY HOISTS and loaded onto a special trailer truck. Called azobe, the wood is a tough, reddish-brown timber, used for making docks and railroad ties.

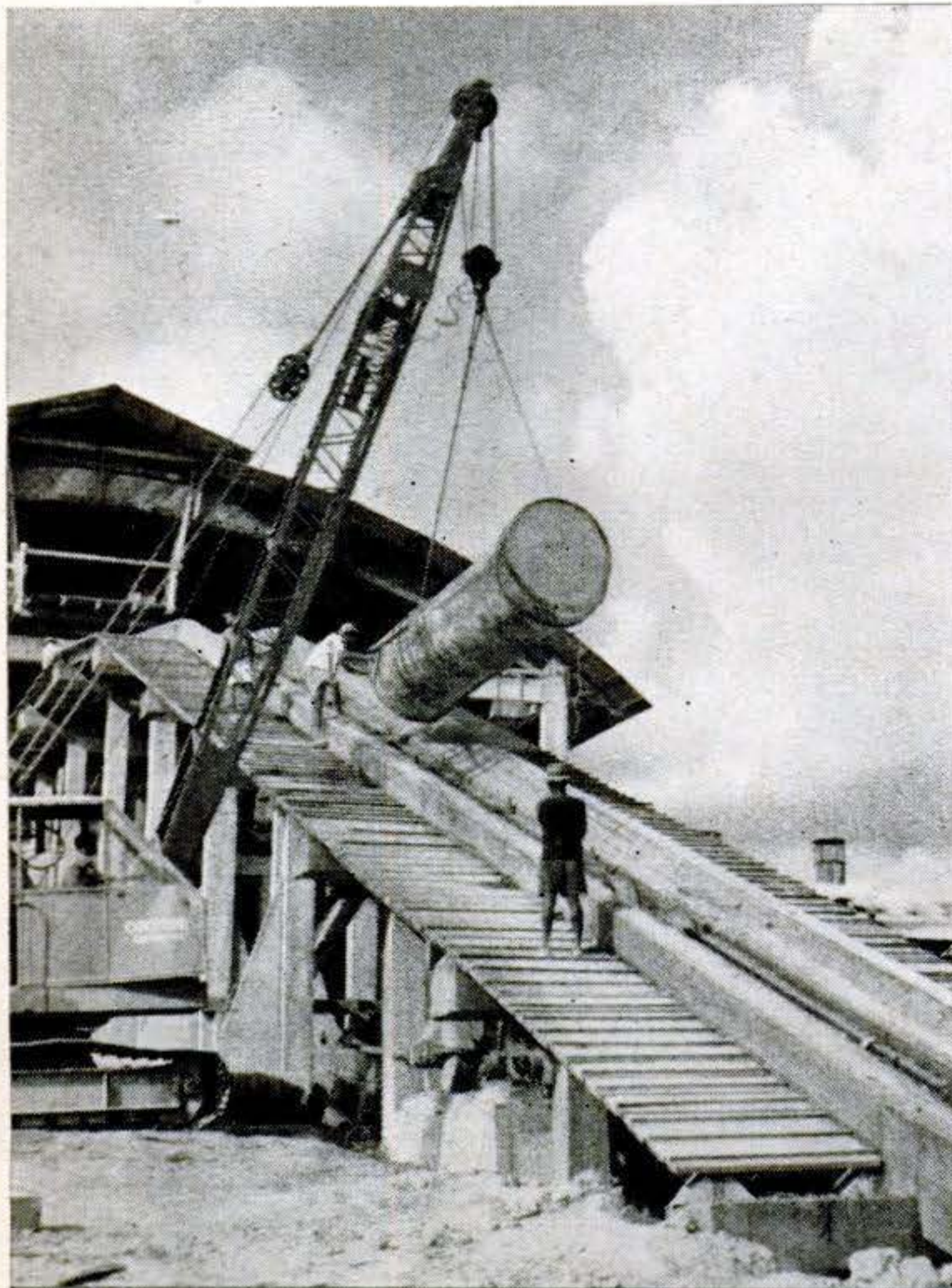

AFTER BEING CUT IN TWO SECTIONS, one part of the log is swung over the ramp onto a conveyor belt that takes it into the sawmill. Natives above guide log as a crane lowers it.

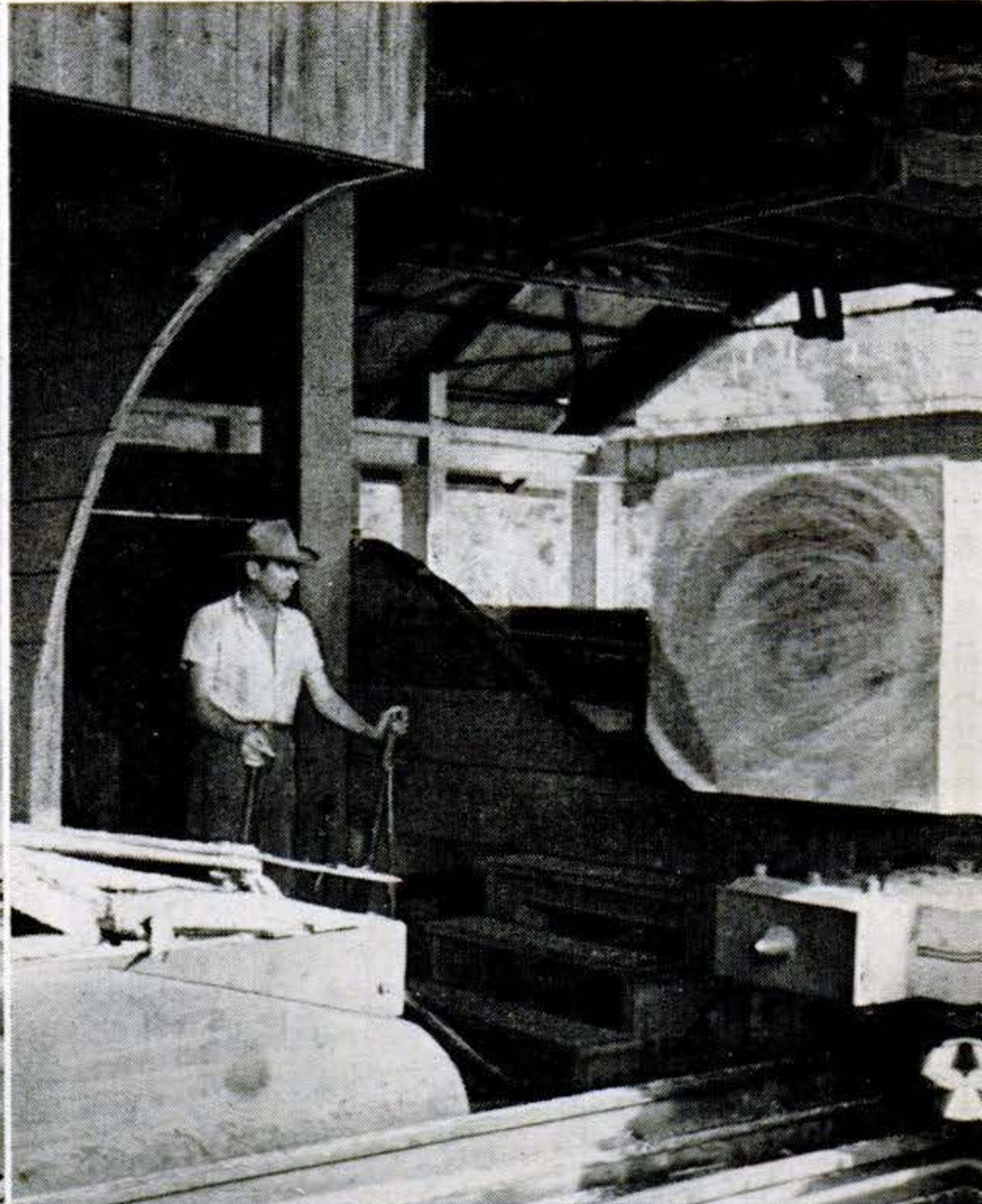

STRIPPED OF ITS BARK, the log moves through the bandsaw to be cut into lumber. The man at the controls is an American, Charlie Dean, who was sent to Eseka to instruct personnel.



DESIGNED FOR A TROPICAL CLIMATE, this sawmill in the town of Eseka has a wide roof to keep out the hot sun, and open sides for good ventilation. Steam-powered machinery,

costing \$68,000 per unit, has been installed in the building. The logs in the foreground above are waiting their turn to be carried up the ramp at the right of the building.



WHEN SAWED INTO BOARDS of specified size, the lumber is carried by fork-lift trucks to a nearby railway for shipment to the seacoast. In the photo above a fork lift raises a load

of boards, dumping them on flatcars. The railway, one of two in French Cameroun, West Africa, runs to Douala, a port city 110 miles away.

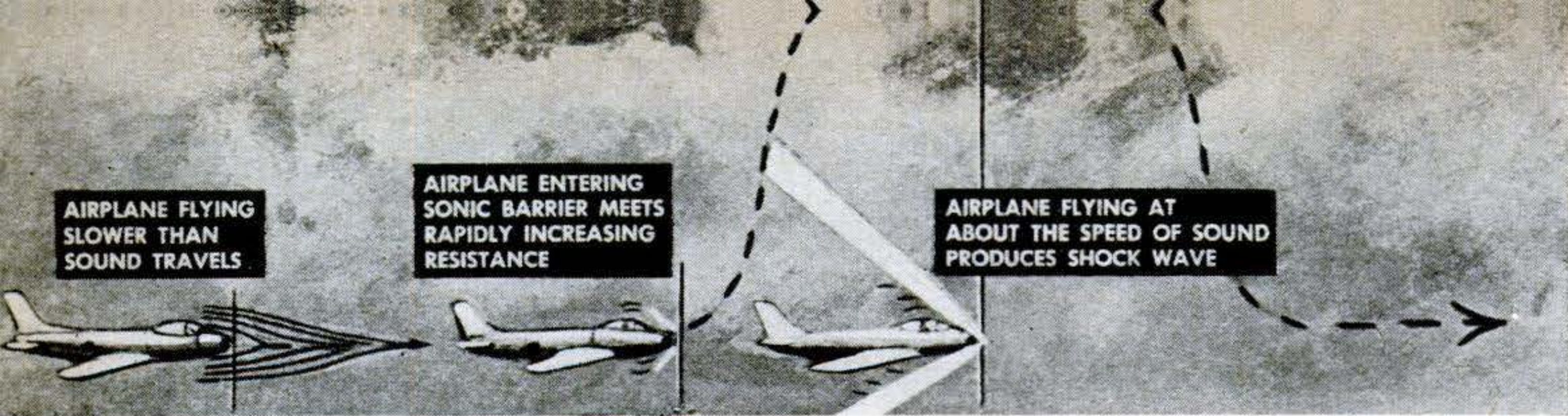

AIRPLANE FLYING SLOWER THAN SOUND TRAVELS

AIRPLANE ENTERING SONIC BARRIER MEETS RAPIDLY INCREASING RESISTANCE

AIRPLANE FLYING AT ABOUT THE SPEED OF SOUND PRODUCES SHOCK WAVE

SONIC BARRIER, encountered abruptly when a plane matches the speed of sound, is a sharp

increase in air resistance. Only knotty mathematics can explain exactly why it occurs.

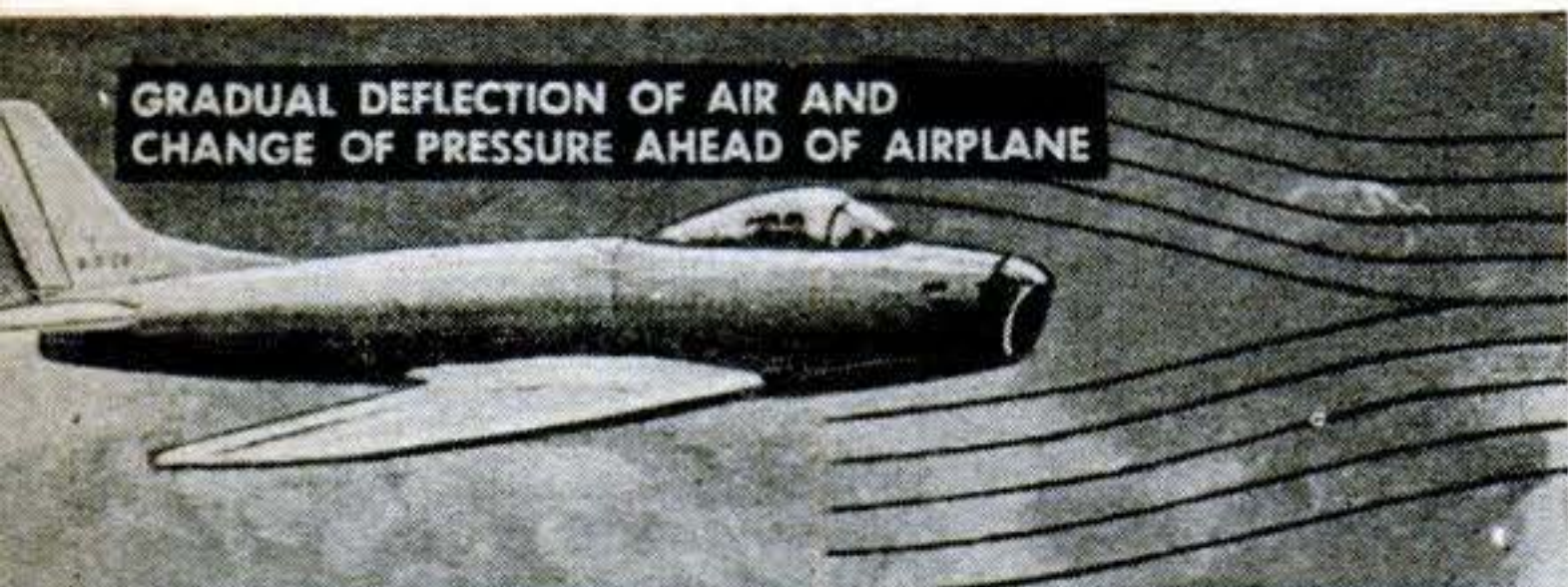

GRADUAL DEFLECTION OF AIR AND CHANGE OF PRESSURE AHEAD OF AIRPLANE

AT SUBSONIC SPEEDS, sound waves race ahead of an airplane in flight and disturb the air in its path, thus deflecting the air and increasing pressure comparatively slowly.

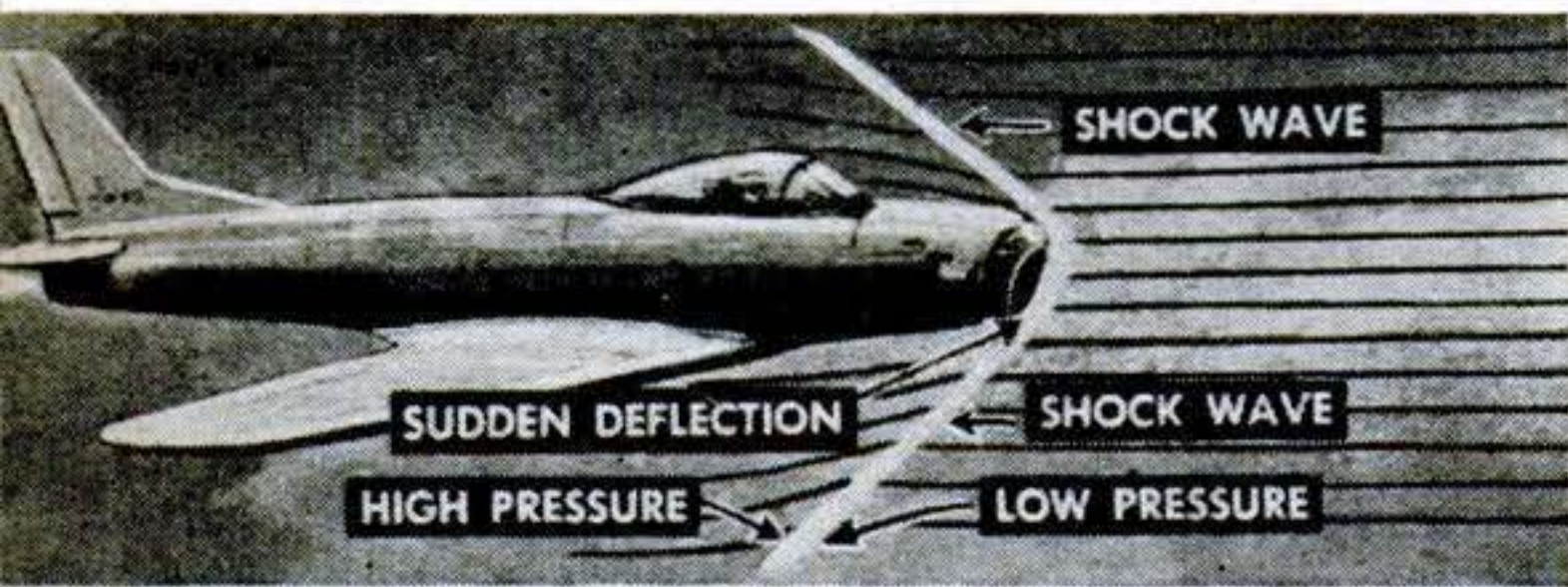

AT SUPERSONIC SPEEDS, sound waves lag behind. The airplane hits the air ahead with no warning, deflecting it and increasing its pressure violently, creating a shock wave.

Why Supersonic Planes Go Boom

YOU can't hear a plane that is traveling toward you faster than 700 miles an hour, which is just about the speed at which sound itself travels. But you know when it has shot past you, for you hear a sudden, sharp explosion, like the crack of a rifle fired nearby. What you actually hear is the delayed report of the plane's collision with the so-called sonic barrier, a kind of wall of air that suddenly builds up in the path of any object overtaking the speed of sound.

The public is gradually getting used to this startling noise as more and more planes—Sabre jets, for instance—smack through the sonic barrier.

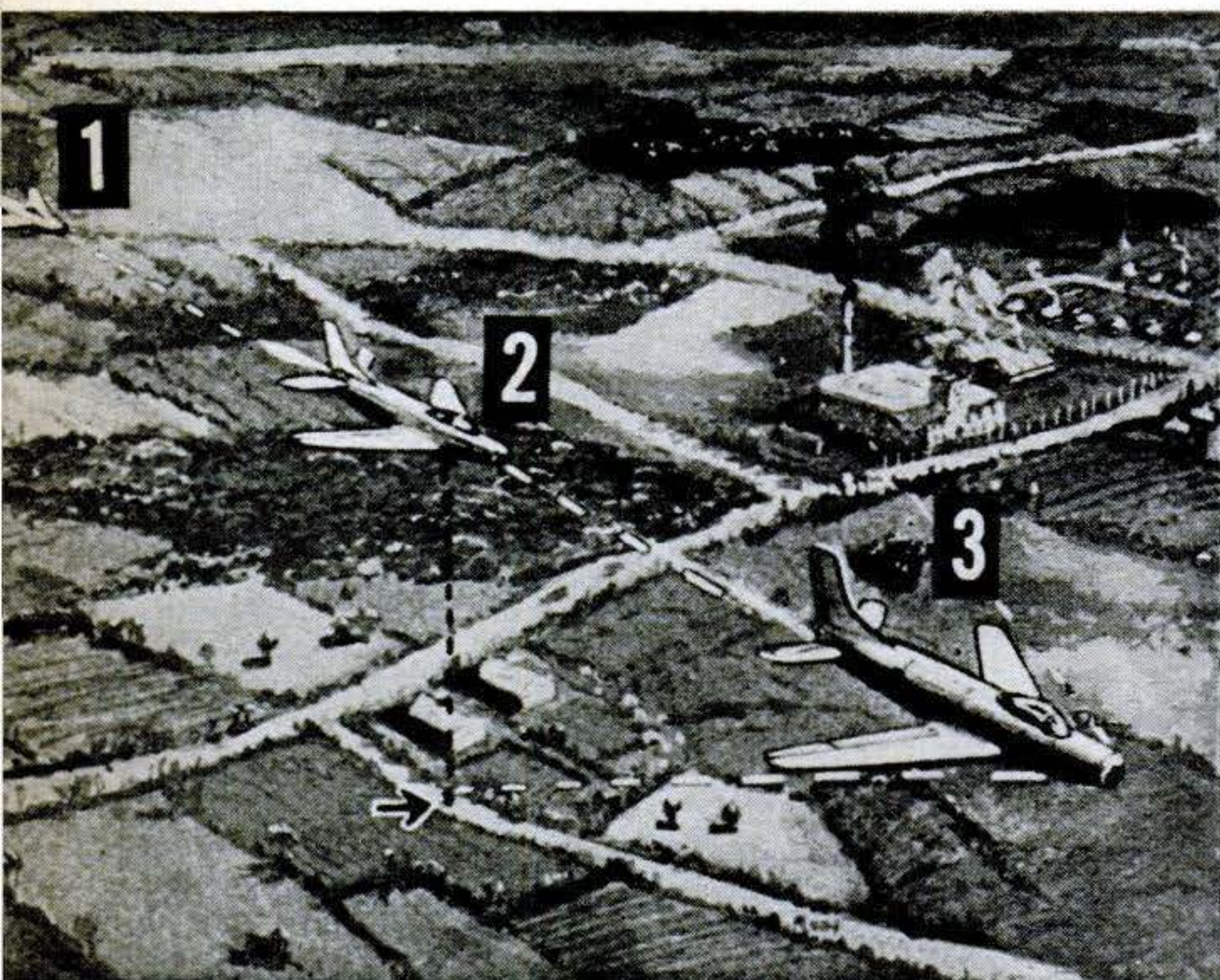

YOU CAN'T HEAR a plane traveling faster than sound as it approaches (1) or when it's overhead (2) because the shock wave fans out

behind (3), like the wake of a ship, striking your ears with sudden force and an explosive sound (right above) after plane has gone by.

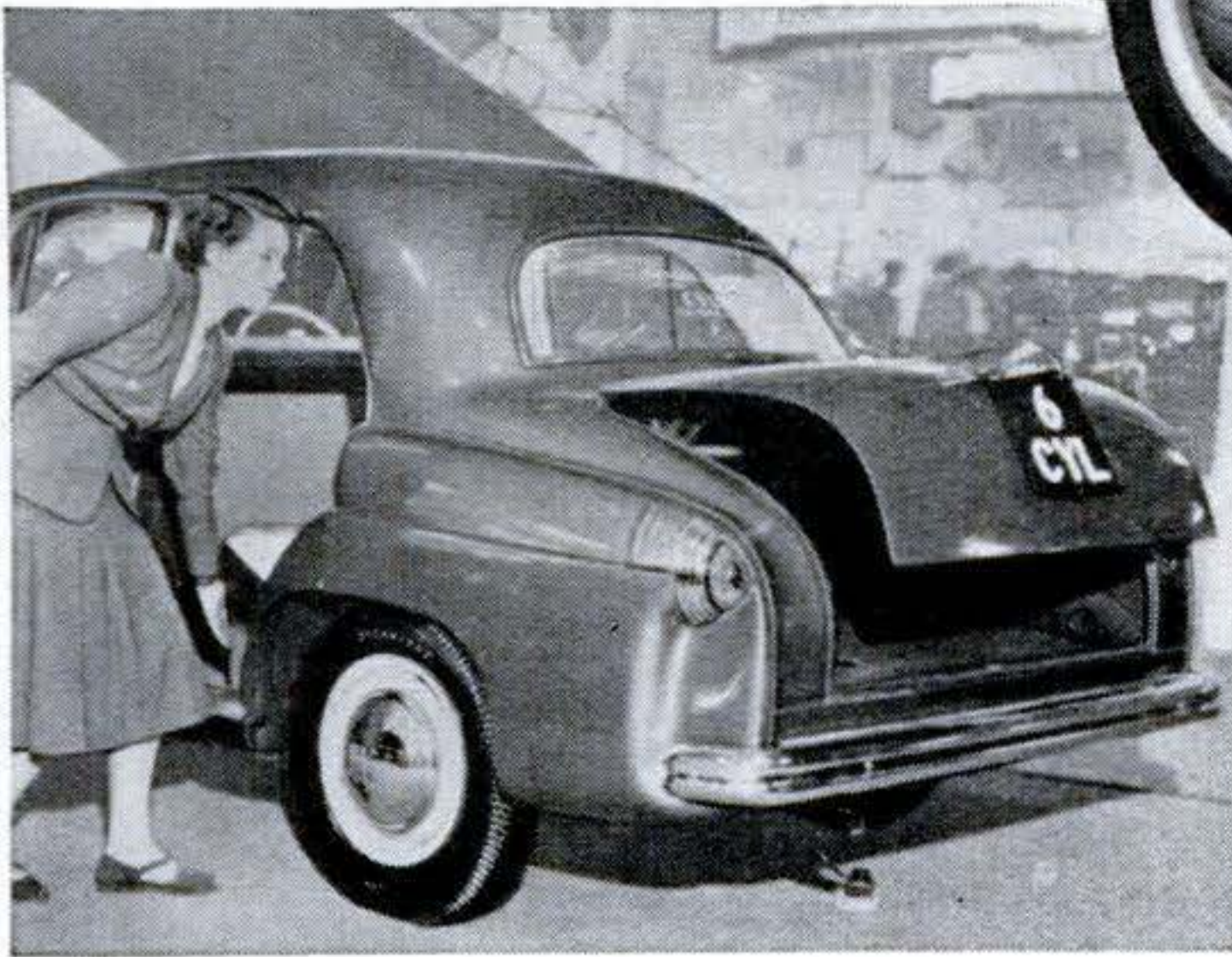
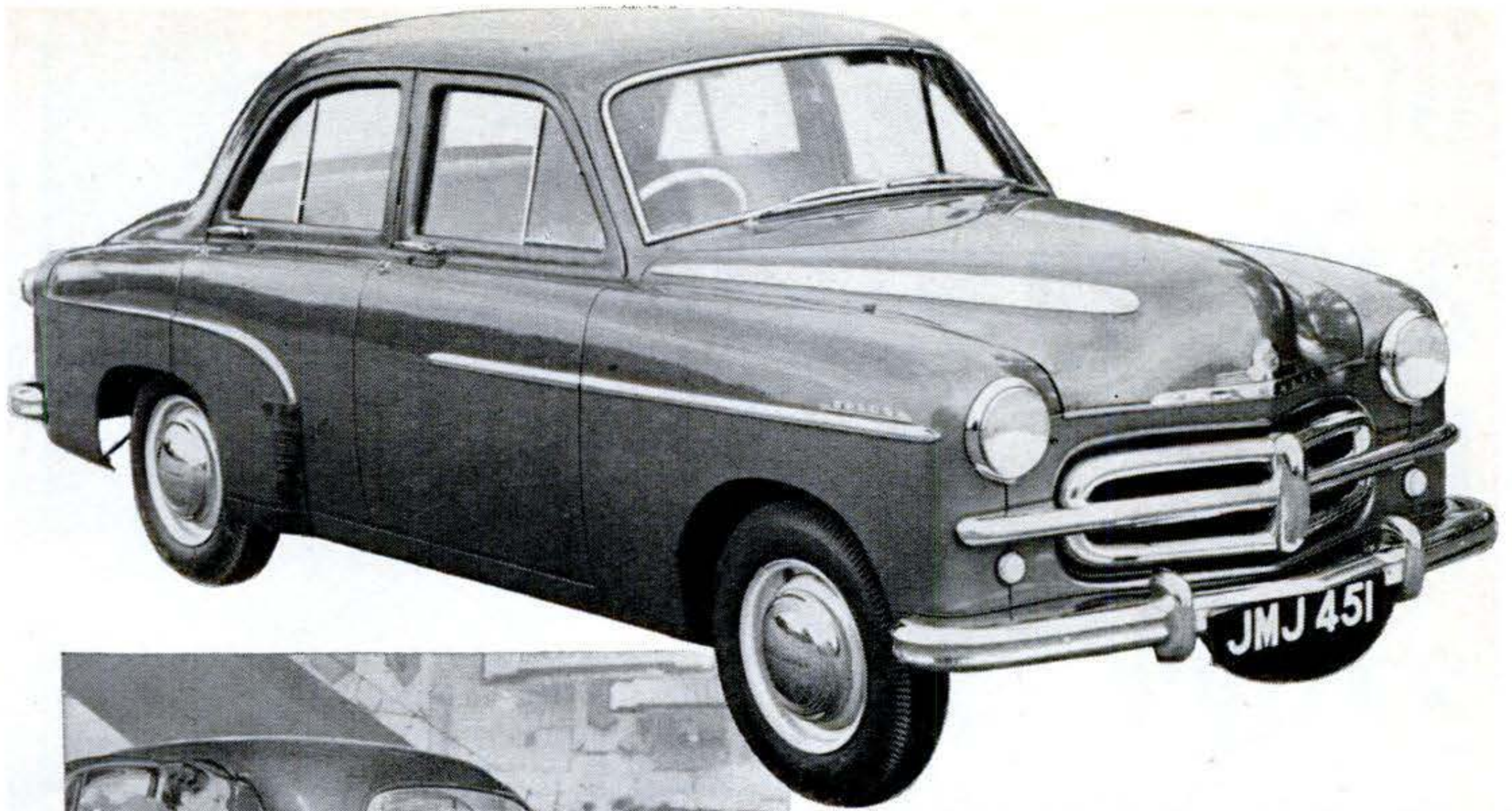

Inside Button Opens Car Trunk

You need no key to unlock the luggage compartment of the new British four-door Velox sedan (above). Press a button beside the rear seat and it springs open (left), close the cover and it locks itself again. Made by Vauxhall Motors, Ltd., the six-passenger car has a six-cylinder engine of 2¼-liter (137-cubic-inch) displacement and sells in England for about \$1,000.

Tiny Radar Steers Missile

SUCH marvels of electronics as a five-tube radar amplifier no larger than a cigarette package (right) help guide the guided missiles. They are used in weapons like the air-to-air, rocket-propelled Ryan Firebird (below). Like their huge counterparts on land and sea, the Tom Thumb radars bounce echoes off targets—and do it automatically, in the bargain.



How a Champ Drives a Truck



**Here's his secret for dodging trouble while highballing
some 36 tons of rolling weight at passenger-car speed.**

By John H. Castner

Three-Time National Truck-Trailer Champion

as told to R. P. Stevenson

FOR the past 13 years, I have been driving the biggest thing on the road—a huge truck and trailer combination that hauls a payload of 19 tons or more.

My outfit is one of the world's largest highway freighters. You meet combinations of such size only in the extreme western states. In the East, weight and length limitations keep them off the road.

To equal the over-all length of the typical truck-trailer combination, you would need four medium-size passenger cars, bumper to bumper. From headlamps to trailer tail gate, these rigs span nearly 60 feet. Fully loaded, they weigh as much as 36 tons.

Driving such a highway heavyweight isn't a job for a boy. Looking for work, you can't walk in and say "I'll drive that one." Before you solo, you must learn a lot of ropes and convince your boss that he can trust you with the rolling wealth the rig represents.

My regular run is south out of Portland to Roseburg, Ore., about 200 miles one

way, for the Pierce Auto Freight Lines of Portland. This means going down one night and coming back next morning after an eight-hour layover.

Driving the family car is a picnic compared to tooling a truck-and-trailer combination over the highway.

Climbing into the cab, you become all eyes. Through experience, shifting gears and other mechanical operations are automatic, a part of your reflexes. You can't really concentrate on what's ahead, behind and all around you until the mechanical part has become instinctive.

Drive Ahead of Yourself

Highballing down the highway, you drive ahead of yourself—just as far as you can see. You check side roads before you come to them. You keep an eye on the traffic ahead of and behind you. You glance frequently at the gauges on the instrument panel for telltale signs of impending trouble in the 200- or 300-horsepower Diesel that's rolling you on your way.

You drive relaxed—but always ready for an emergency. If you have personal worries, you put them aside—or try to at least. Many trucking companies now make a practice of

helping drivers through home-life difficulties, overdue mortgage payments, domestic wrangles and the like. They know the worried driver can't give full attention to his job.

Defensive Driving at Work

All this adds up to what truck drivers know as defensive driving. But that doesn't mean outguessing other drivers. Far from it. The safety department of the American Trucking Association defines defensive driving as "operating your own vehicle with such care that, no matter what other drivers do, you will be able to protect yourself and not become involved in accidents because of their mistakes."

Suppose you were coming to an intersection on a through highway in open country. Off to the right, you could see a car approaching on a side road you knew to be marked with a stop sign. You noticed the driver remove a hand from the wheel to emphasize a point in his conversation, perhaps turning toward the passenger. Suppose the car would reach the intersection at the same time you would.

That's where you should go into defensive driving. Any safety-minded truck driver would. Even though we think the car would stop, we wouldn't take chances.

As a sidelight on that, I have noticed that a woman driver, alone, is exceptionally good, a lot more conservative than a man. But if she has somebody with her, her mind is more apt to be taken away from the job of driving—by conversation, by turning to look at a shop window.

THREE-TIME CHAMPION
John A. Castner is shown here with other winners of the 1951 National Truck Rodeo. Left to right, they are Albert Pomahatch, St. Paul, a tractor and single-axle trailer driver; Alex Adamski, Chicago, tractor and tandem-axle trailer driver; Mr. Castner; and James E. Tucker, Charlotte, N. C., straight truck driver. Mr. Castner, who also won the rodeo championship in 1949 and 1950, was picked as the trucking industry's driver of the year, too, in 1950. He has driven a truck for 13 years now without an accident.



TYPES OF TRUCKS

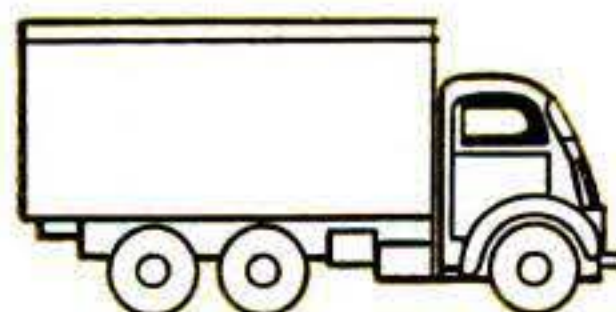

STRAIGHT TRUCK

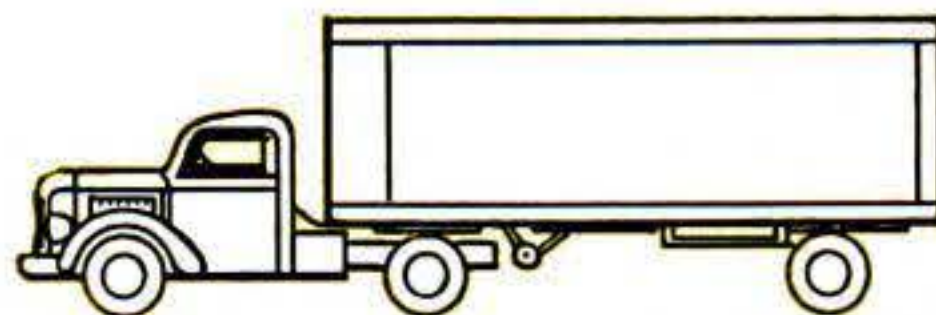

TRACTOR, SINGLE-AXLE SEMI-TRAILER

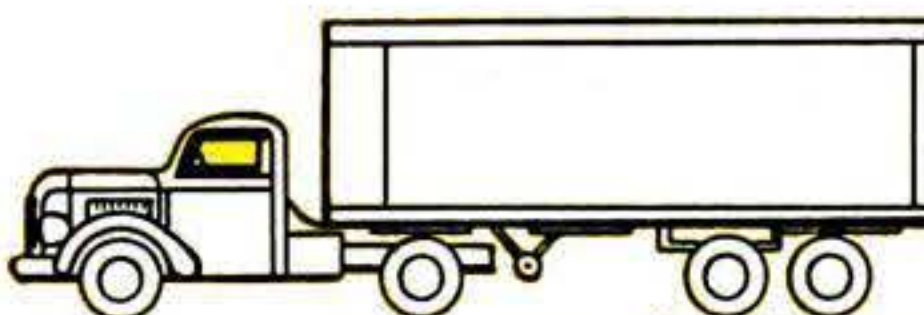

TRACTOR, TANDEM-AXLE SEMI-TRAILER

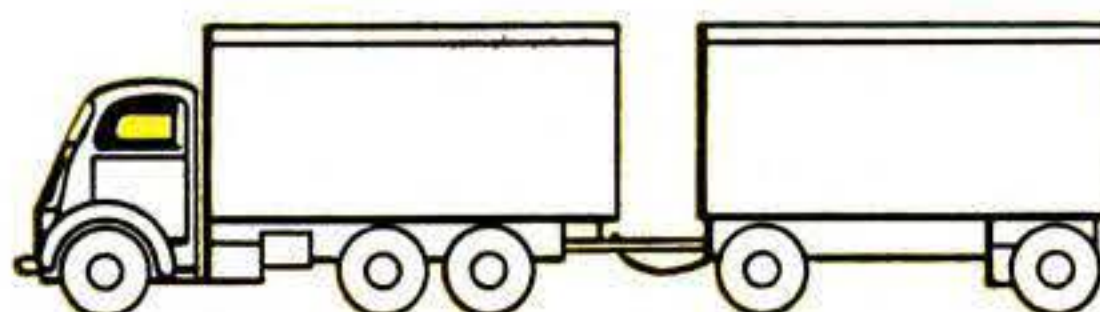

TRUCK AND FULL TRAILER

On a run, a truck driver tries to maintain an even speed. But for safety, speed is always suited to road conditions. On a dry road, 50 or 60 may be okay, but on snow or ice 25 miles an hour may be too fast.

To qualify for a state or national truck rodeo, a driver *must* pay attention to details like these. An accident automatically bars him from the next rodeo. After he has driven for a year without an accident, he still doesn't get into the final field tests on truck inspection and driving until he has



WINNING COMBINATION. Here's the giant truck and full trailer combination that John H. Castner, author of this article, drove in winning his third national title in the 1951

truck rodeo at Chicago. The combo is nearly 60 feet long. The four class winners at the rodeo each year become top men among nearly eight million truck drivers in U. S.

proved his knowledge of safe driving, the trucking industry, first aid and fire fighting. Personal appearance counts too.

Whether you are driving a truck or a car, I think one of the most important safety

rules is keeping to the extreme right of the highway. This makes it possible for a person behind to see around without crossing the center line. And on a curve, keeping to the right may give just the margin needed

Truckers Use These Formulas for Safe Driving

HOW quickly can you stop? Next time you are on the road, test yourself with these two formulas. Truck drivers have found them right on the nose.

When an emergency looms, it takes time to apply the brake. Meantime your car speeds ahead. This first formula shows how

travel before you can react and hit the brake. And you still must stop.

The second formula shows about what

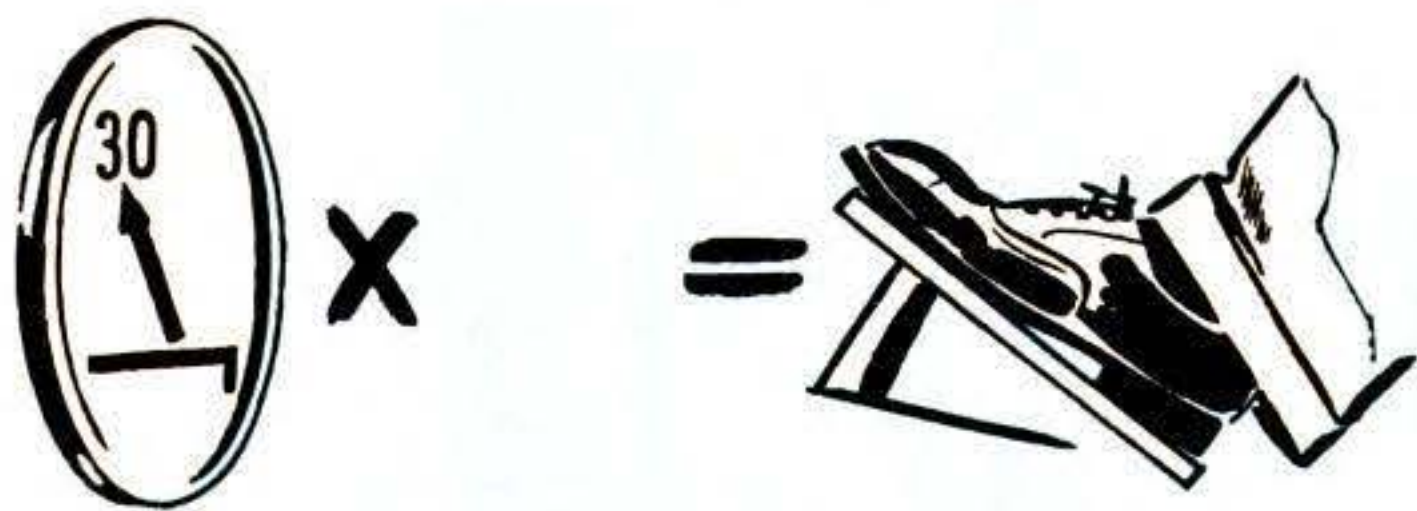

far you'll go if your reaction time is average. Multiplying your speed by $1\frac{1}{2}$ gives the approximate number of feet the car will

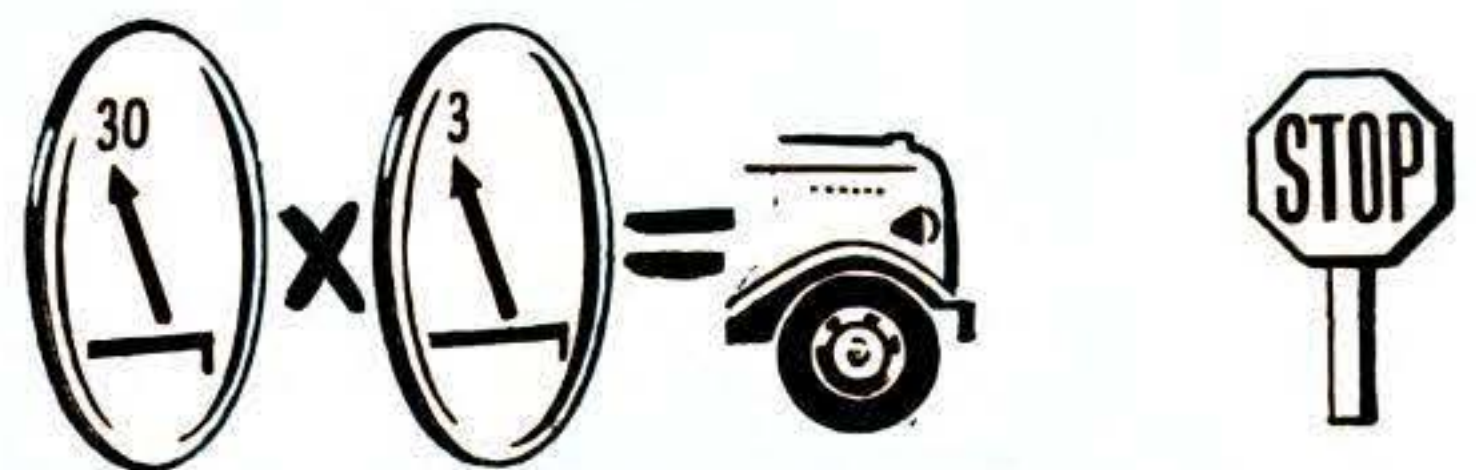

clear distance ahead you need for any speed—if you are to stop safely. Multiply your speed by the first digit of that speed. In the example above, it is 30 times three—or approximately 90 feet.

to miss an oncoming vehicle that swings wide over the dividing line.

There would be a lot fewer accidents if all drivers made certain they had enough clear space ahead before trying to pass. When a car is almost abreast of me and another car or truck suddenly appears coming in the opposite direction, I find it difficult to judge what the passing driver will do. Will he speed up—and make it? Or will he drop back? If I slow down, hoping he will pass, is he also likely to slow? As the best way out of such situations, truck drivers usually maintain the same speed. But don't count on that. It is safest to pass only when you are sure you have enough space.

Safety rules of the U. S. Interstate Commerce Commission require interstate trucks to stay far enough behind a preceding vehicle so an overtaking vehicle can enter and occupy this space without danger. Truck drivers know the practice of following too close as tail-gating.

What Truck Signals Mean

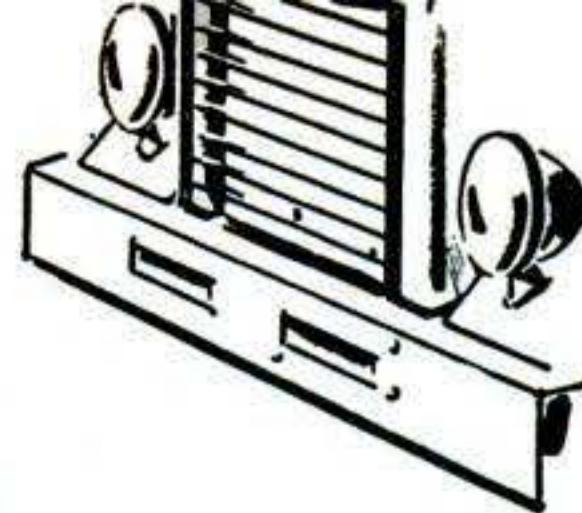

Drivers frequently flick their lights to pass information back and forth. Common signals:

One flick—"Look out ahead." (Used to warn of such things as a wreck, a road obstruction, a police check.)

Two flicks—"Hello."

Three flicks—"I'm stopping. Please do the same."

In my opinion, police should place a reckless-driving charge against any motorist who consistently stays only five or 10 feet behind another vehicle at 50 or 60 on the highway. If the car ahead stopped suddenly, the man behind couldn't possibly react fast enough to avoid a pile up. END

REQUIRED Reading for Truck Drivers

TRUCK drivers who become champions know this 90-page booklet by heart. Samples of its questions and answers:

Q. How does a bumpy or choppy road surface affect stopping distance?

A. The tires spend part of the time off the surface, lessening friction and increasing stopping distance.

Q. How does the professional driver overcome the glare of oncoming headlights?

A. He directs his eyes toward the right-hand edge of the pavement.

Q. What are the first symptoms of carbon monoxide poisoning?

A. Drowsiness, lightheadedness, headache.

Q. What should a driver do when symptoms of carbon monoxide appear?

A. Park his vehicle, get out into the air until the symptoms disappear and thereafter ride with a window partly open.

Q. What is one simple method by which a driver can check brake equalization?

A. By feeling brake drums for heat after a series of light brake applications. An unusually hot or cold brake drum indicates that brakes need adjustment.

Q. What's a preventive for tire fires?

A. Check tire temperature frequently and

see that air pressure is correct. Flat or low tires can cause troublesome fires.

Q. If stalled, wrecked or upset, what are the first two checks that should be made to determine your fire situation?

A. The first two checks that should be made to determine the fire situation of a disabled vehicle are (1) be sure the ignition is off; (2) check for leaking gasoline from fuel tank or broken lines. Fumes may accumulate and be ignited from a short, a static spark or careless smoking.

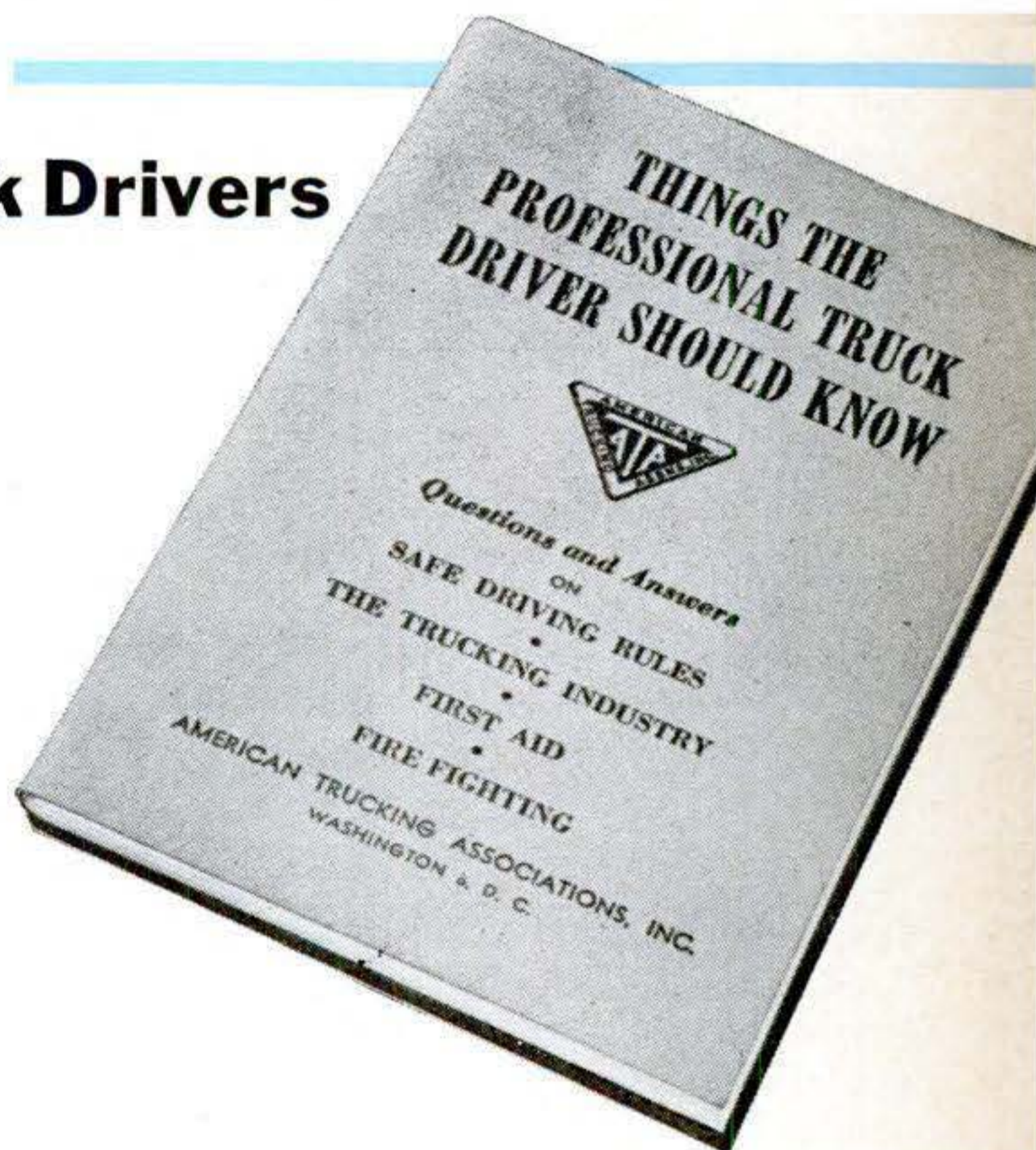

P.S.

Last minute news & notes...

WINTER WEARY? Dr. H. C. Willett, MIT meteorologist, forecasts a fairly prompt arrival of spring in mid-March in the eastern half of the U.S. January will be relatively mild, he says, while February will be cold again, with more snow. He predicts an open winter for the Southwest, and an average winter for the Pacific Northwest.

A NEW DRY CELL, Army developed, lasts twice as long as those now in use, although slightly more costly. It permits use of low-grade domestic manganese dioxide in place of high-grade imported ore . . . THAT OLD HORN SPEAKER up in the attic may be a treasure. A loudspeaker manufacturer says that "horn-loaded" speakers achieve higher efficiency, lower distortion and smoother response than present cone types . . . SECONDHAND TV SETS are being bought, sold and traded like secondhand cars in one Philadelphia store . . . INVENTION MINDED? Here are two things RCA's Sarnoff says are needed: an electronic method of amplifying light for TV and an electronic air conditioner for the home.

A SYNTHETIC MOTOR OIL, said to be better than the natural product, has been developed by Prestone. Tailor-made, it's designed to give quicker cold-weather starting, cut engine ping and plug fouling, free sticky valves, and clean the motor. Some consumers are reported to have found that it needs changing less frequently. Drawback: it costs two to three times as much as regular motor oil . . . BY USING RADIOACTIVE PISTON RINGS, oil-company engineers found that engine wear is increased by low operating temperatures, lean fuel mixtures, pinging. Additives reduce wear . . . EXPERIMENTAL GAS-TURBINE truck uses more fuel but could make up cost by extra load carried, Boeing reports.

A sharp drop in fuel consumption is predicted for future turbines. . . . NEW ALARM SYSTEM made by Bendix Aviation tells bus drivers when their hydraulic systems are low on oil, threatening loss of brakes and steering power.

A SELF-SERVICE LAUNDRY is the latest thing in California drive-in movies: Drop your wash in as you enter, pick it up on the way home . . . LIFE EXPECTANCY is still going up. New U.S. average, based on '49 figures, is almost 68 years . . . OVERLY BOSSY FOREMEN breed accidents, according to University of Chicago. They make anxious workers more so . . . A NEW MOON has been found, but it's no use to earthbound lovers. This heavenly body revolves around far-away Jupiter, which already has 11. It shows up as a speck on a photographic plate exposed at Mount Wilson Observatory.

SEA SCORPIONS six feet long have been found in Ohio. But they don't have stingers. And they died about 400,000,000 years ago . . . HAWAII is silently dropping into the ocean --but it still has 70,000,000 years to go say geologists. Just to even things up, Baffin Island, in the Arctic, is rising six feet a century.

A NEW RUBBER-BASE PUTTY is said to resist vibrations better than ordinary kinds. It comes in colors . . . LATEST AIR FORCE TIRE CASING will take a 240-m.p.h. landing without blowing out, but is not much larger than ordinary auto-tire casing.

A VITAMIN B DEFICIENCY in the scalp is blamed for dandruff by researchers for National Vitamin Foundation. Ointments containing the missing vitamin cleared up dandruff temporarily; vitamins taken internally had no effect . . . PLASMA STORAGE methods may be changed. Research shows that cold-storage often preserves viruses such as jaundice, while storage at ordinary room temperature kills them . . . THE DREADED "STREP" GERM is the base of a new English antibiotic called streptozyme . . . NEWEST SLEEP DRUG, Dormison, is reported non-habit-forming, gives quick restful sleep.

The Editors

MECHANICS *and* HANDICRAFT

REG. U. S. PAT. OFF.



Electric Trains Are Fun All Year

Don't pack them away with the Christmas decorations. Give them a permanent place—and they'll give you a permanent hobby.

By Henry Abraham

MANY a new electric train highballs under the tree on Christmas morning. For a couple of weeks it runs on a rush schedule, with Dad pulling the throttle as often as Junior. But about January third, Dad gets back to the newspapers and Junior finds the sledding is wonderful.

That's when Mom pulls the track apart and retires the rolling stock to a closet roundhouse. If Dad and Junior notice, it is with relief at escaping the cleanup chore.

How come? Why does a train lose its appeal? Nine times out of 10, it is because the layout is on the floor. That's like putting glue on a fielder's mitt. You just can't play

JANUARY 1952 | 61

How to Make the Most of Tinplate



CONTROL PIT inside table gives a full view of train movements on this slick O-gauge layout. The switch tower in which the operator sits has only two walls and can be lifted off easily.

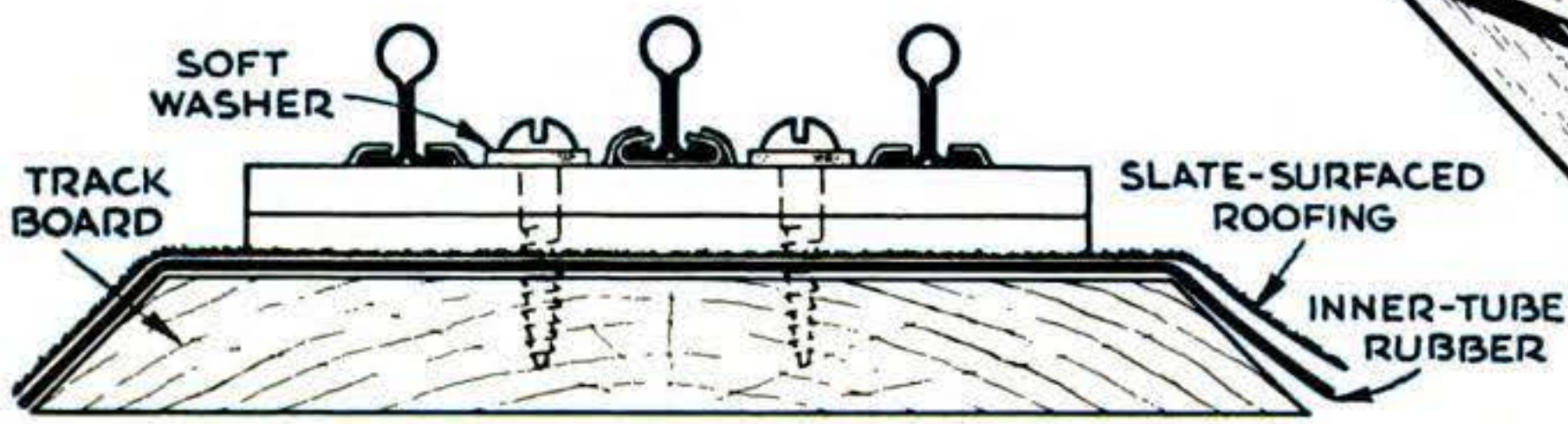
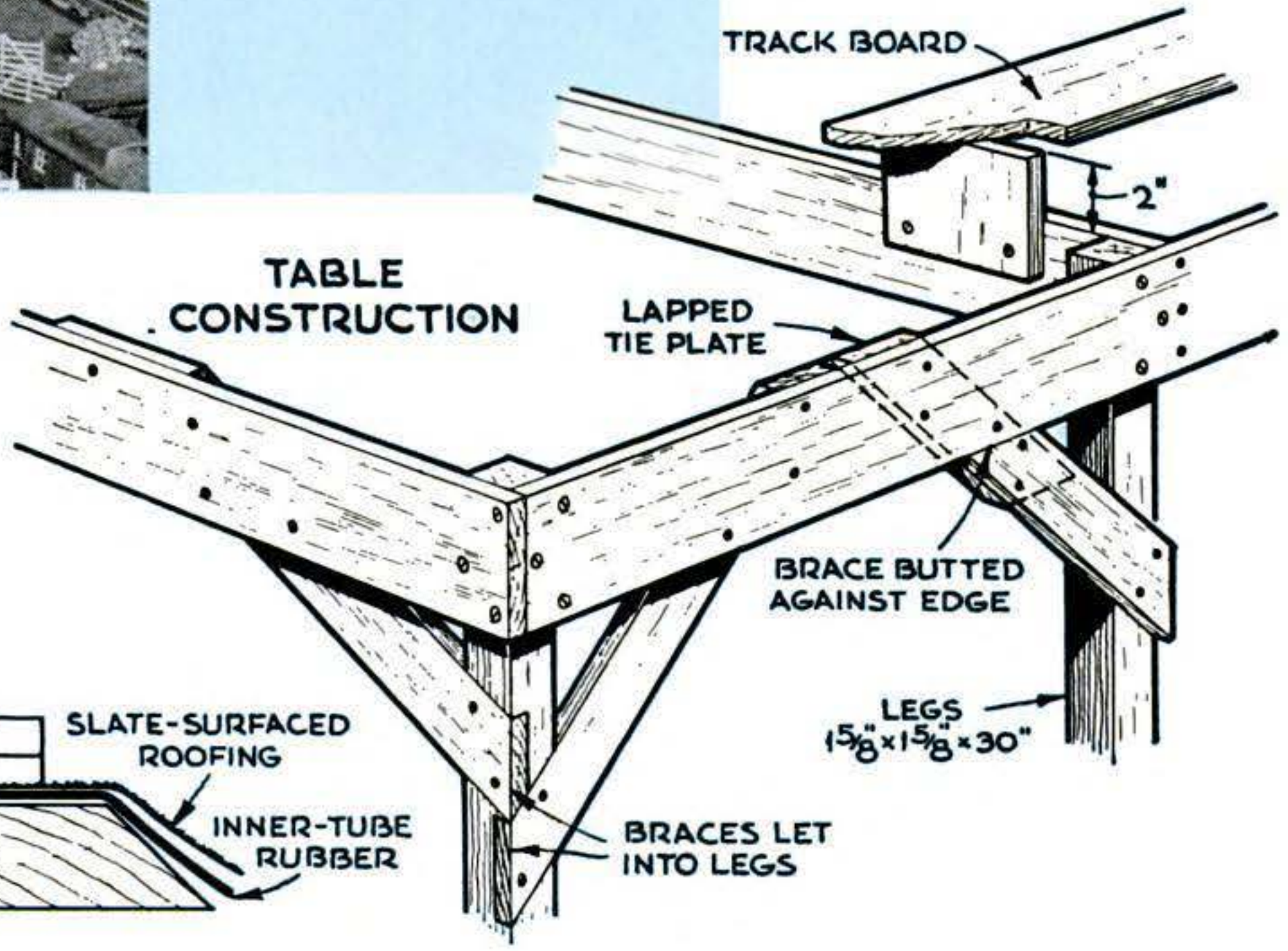
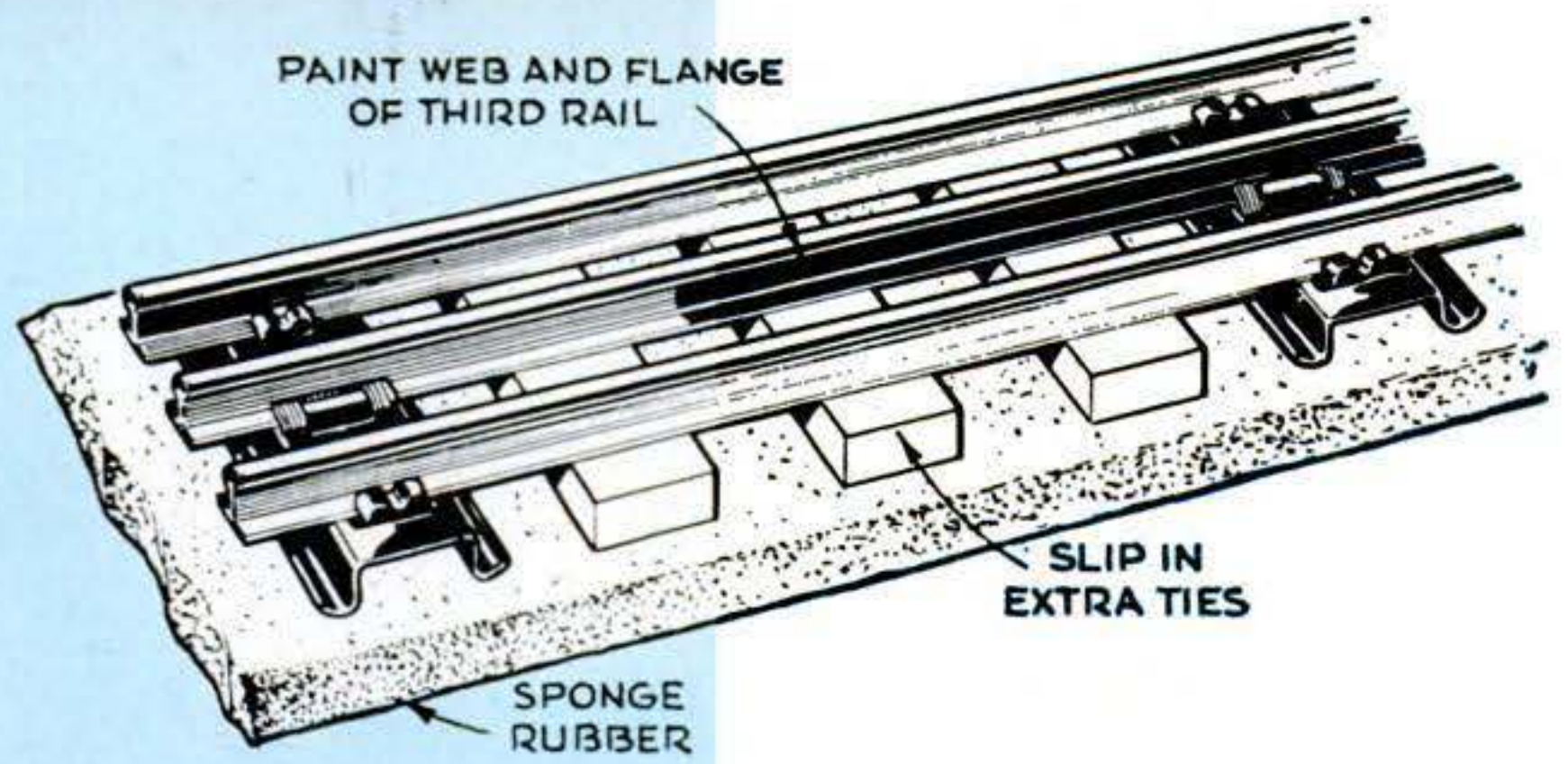

that way. Dad gets cricks in his back, Mom can't clean, track and rolling stock are stepped on, and Junior realizes that broadloom doesn't look much like scenery.

Keep it rolling. Model railroading is too much fun to let this happen. But if the model pike is to be ready for the kids on a rainy afternoon—and for Dad to play Casey Jones after supper—the layout must be set up so that it can be used any time. That entails mounting it permanently off the floor, so that the tedious chores of setting it up and packing it away are unnecessary.

My own real interest in the hobby, for example, began only when the trains were mounted on tables. In the 12 years since, my enthusiasm has grown along with my layout, which now nearly fills a big cellar.

Where to put it? A good site for your permanent layout is the attic, cellar, garage or spare room. But if you don't have any of these to pick from, you can hinge the track panel to a wall along one edge and hinge drop legs to the outer edge. This gives you a railroad that folds out of the

way when not needed. Another dodge is to put casters on the panel so that it can be rolled under a bed.

If you have a choice, the cellar is usually the best location. In an attic, low headroom may make much of the floor unusable, and winter cold and summer heat are extreme, whereas a cellar is moderately comfortable at most times. A garage layout may be all right in Florida, but I'd rather not have one in Maine or Wyoming.

A spare room is fine if it's really spare. You don't want to pull spikes every time cousin Agnes comes visiting.

Tinplate or scale? Once you've decided where to put your permanent railway, plan the layout. This depends a good deal on the equipment you have. *Tinplate* models, the kind that start many a model railroader off, get the name from their tinplate tracks. The curves are sharper than scale curves, and they don't look much like real rails. But you can push the sections together, clip on the power leads and have a train running in five minutes.

Scale track is a miniature version of the

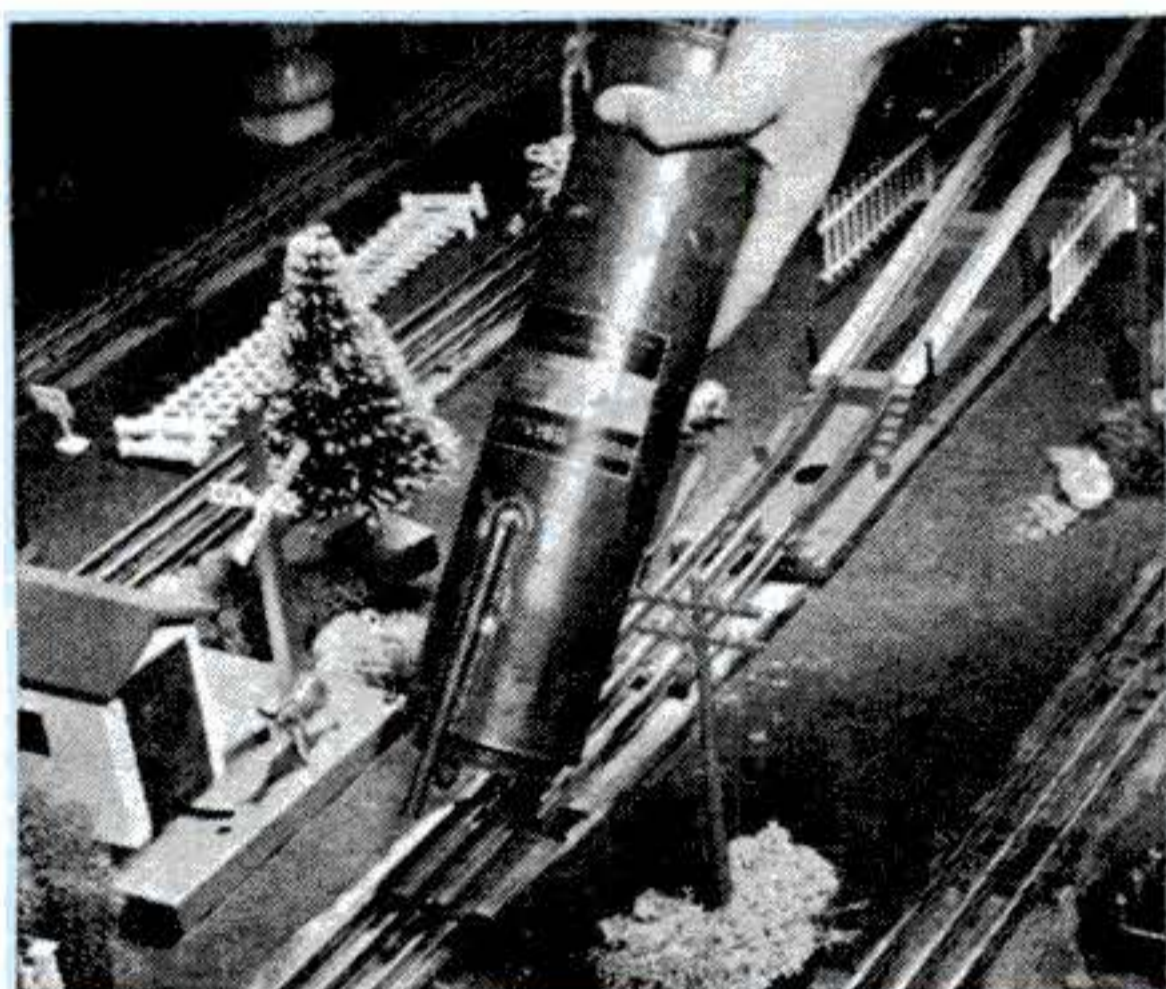
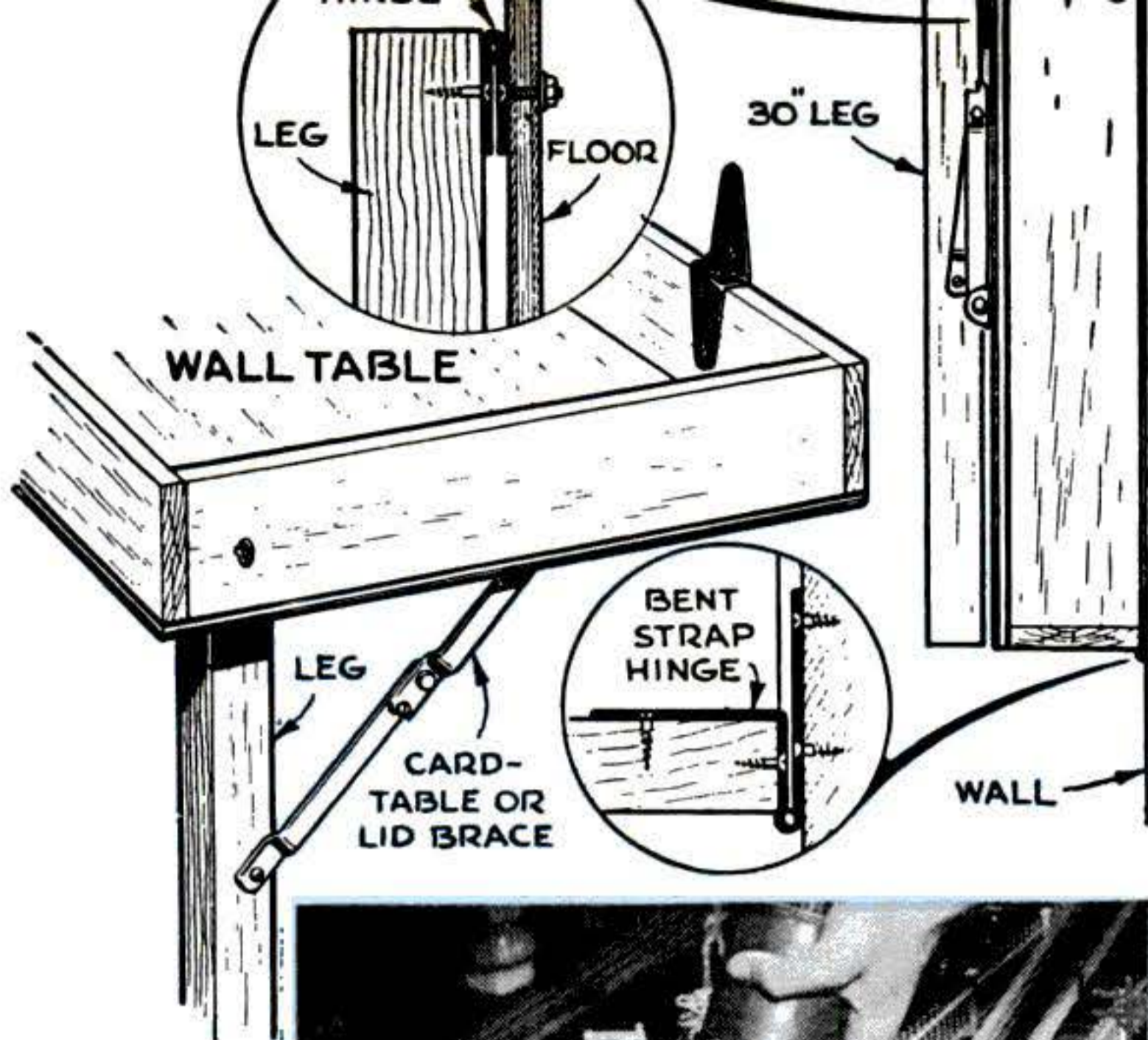

RAYON FLOCK, blown from handgun, becomes grass, sand or ballast.

real thing. Rails are solid brass, aluminum or steel, spiked to wood or fiber ties. You can spike your own rails or buy them ready-mounted.

Maybe, like me, you'll start with tinplate and go on to scale later. Let's assume you have tinplate now, and see how you can make the most of it.

Any layout worth the name will even-

tually need room for turnouts and parallel tracks, so your space should be at least 4' by 8'. I recommend making a drawing of your railroad-to-be on paper ruled into squares, each representing one square foot. Be sure to allow room for trackage and features you will want to add later—including those you haven't thought of yet!

Don't be a flatlander. If you want a realistic layout—and I think that a lot of the fun lies in making it look like the real thing—don't put your tracks on a flat, overgrown table. Only a scenic artist can make a flat plywood panel look like anything else. Instead, build a supporting framework 30" high and on it put just enough flat stock to form your roadbed. Better still, mount the track boards on supports 2" above the table framework.

This construction permits a greater variety of scenery. Hills, valleys, rivers, cuts and fills are easier to create. The open spaces between tracks are filled at different levels with plywood, scrap lumber and wire screening. Plaster applied over this transforms it into realistic terrain.

And while you're building the supports, don't forget that noise will be a problem. Put a sound-absorbing layer of thick felt, 3/8" sponge rubber, cork board, roofing paper, or inner-tube rubber under the tracks. Even the screws that hold down the tracks conduct noise. Sound-insulate these with a bit of cardboard under each screwhead.

Don't omit any of the track-connecting pins. If any are loose, see if the rail has opened. If squeezing it back into shape doesn't remedy matters, bend the pins slightly to make them a tight push fit. The inside of all rail joints should be flush, or you can expect derailments and noisy run-

How Tinplate Gauges Compare

The 2½"-gauge trains Dad played with are museum stuff now. Today's standard tinplate is O gauge. It is all 1¼" between outside rails, but the O27 type, made for

compact layouts, turns sharper curves and is lower than regular O. The two cannot readily be mixed.

S-gauge tinplate and HO-gauge tinplate both have square rails and two-rail electrical systems.

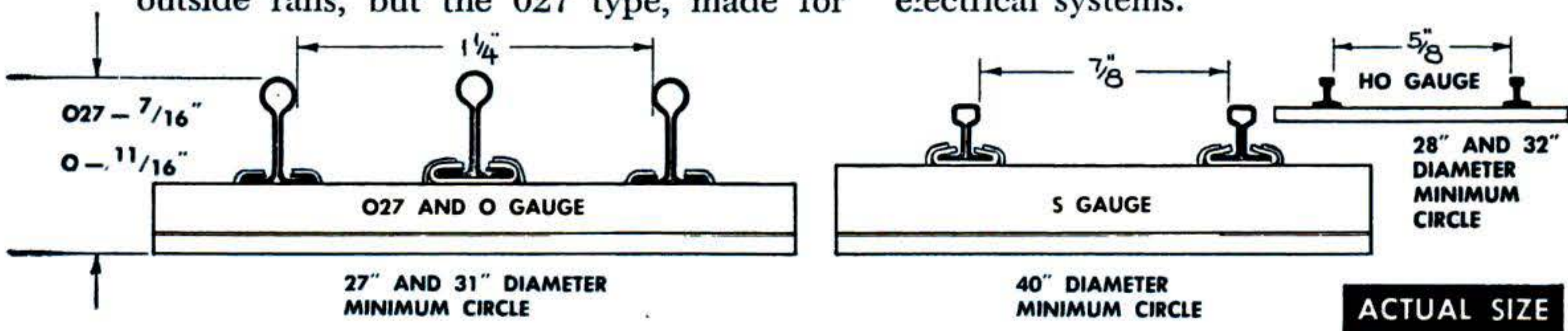

This Is Scale Railroading

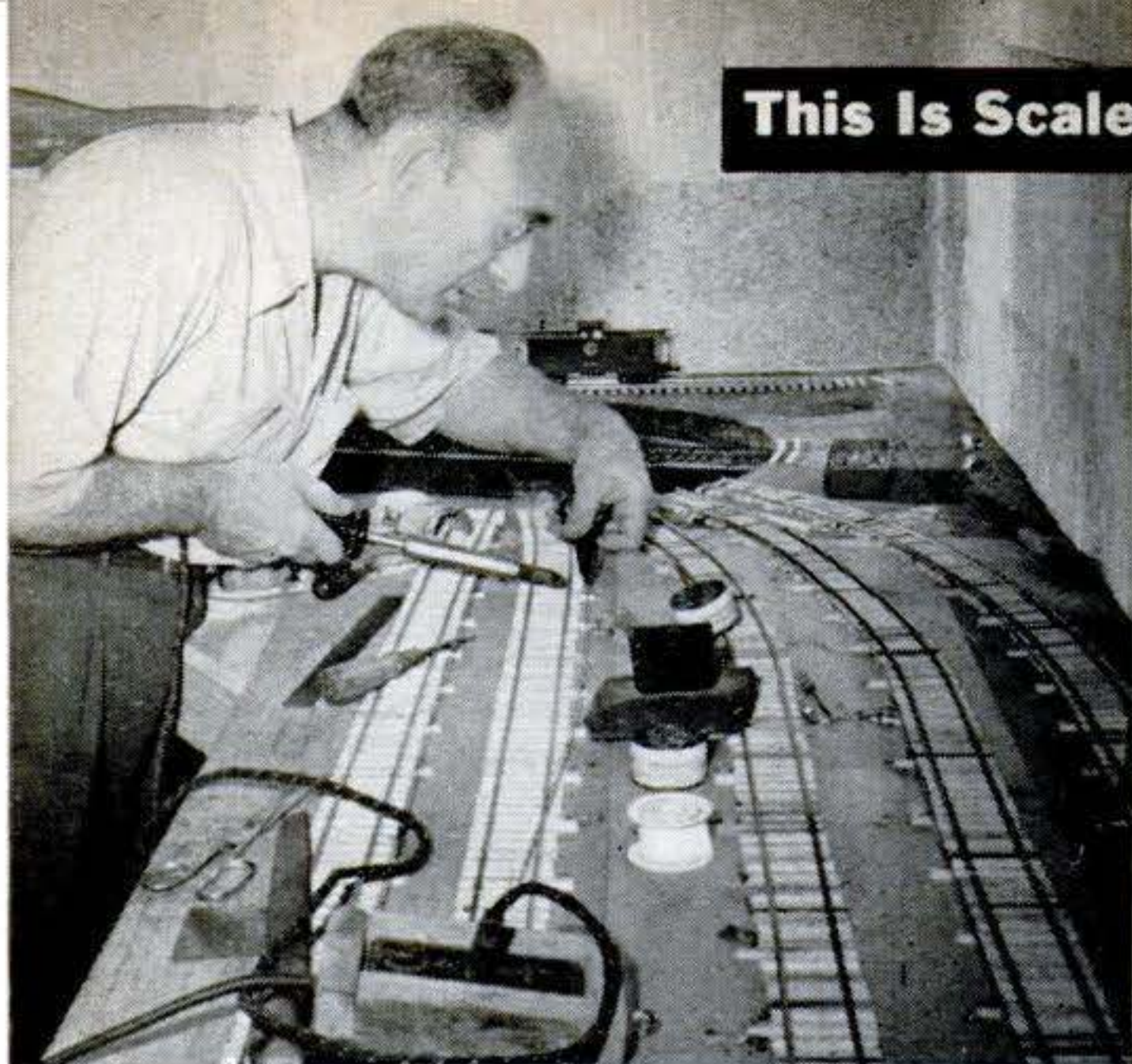

YOU'RE NEVER DONE, once hobby has a good hold. Here author lays new track to turntable (at rear). Solid rails are spiked to wooden ties. Ability to solder is a must.

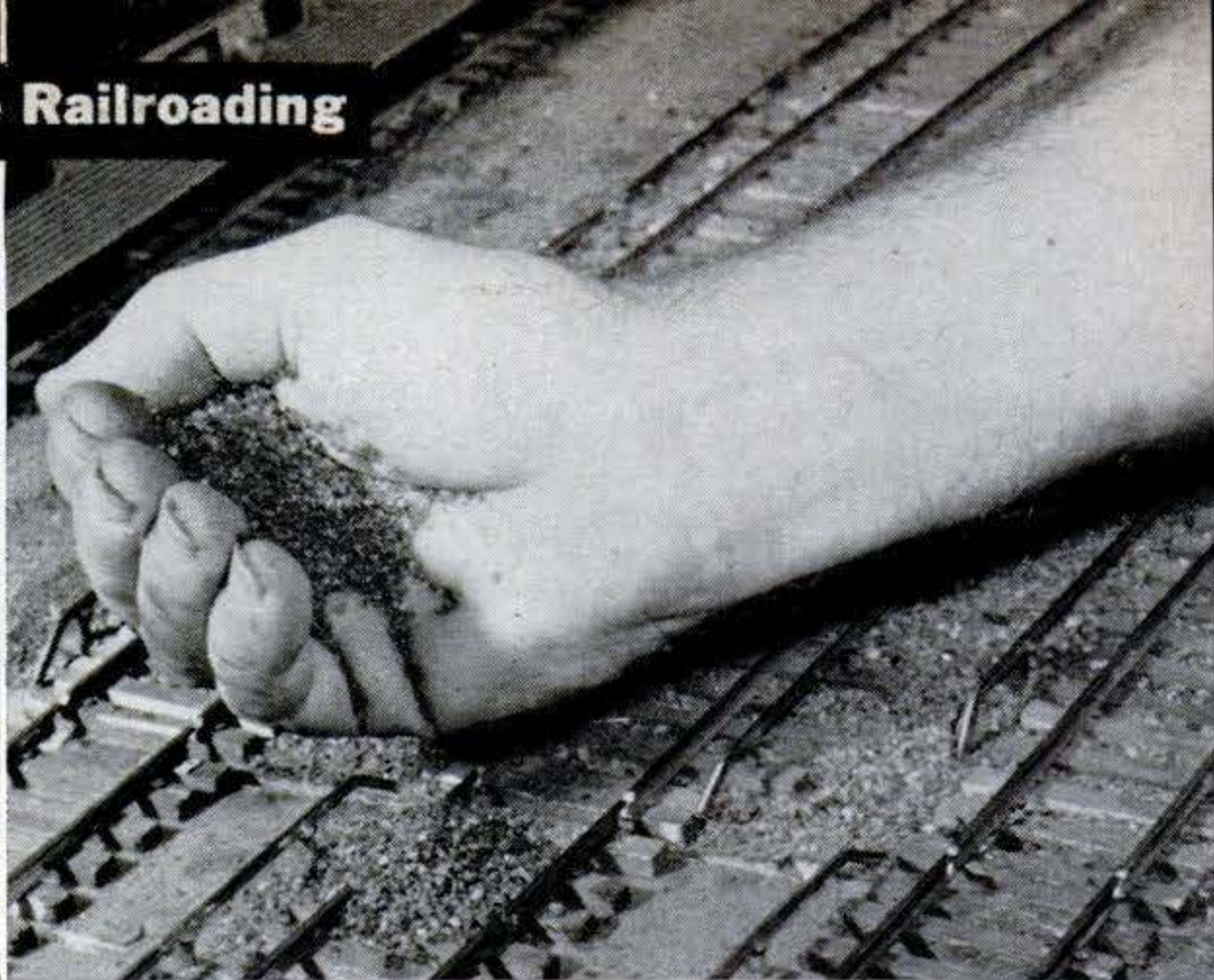

TRACK BALLAST is bird gravel, dyed gray. Outside third rail makes for simpler wiring than a two-rail system, and closely resembles full-size electrified construction.

ning as the wheel flanges pass the joints.

Make it look real. Gray sponge rubber, beveled at the edges, looks like a ballasted roadbed. So does slate-surfaced roofing paper. Or you can paint the roadbed with glue and sprinkle on bird gravel.

Sand, dirt and grass surfaces are nicely imitated with flock—tiny rayon fibers you blow on over an adhesive coating. It comes in all colors.

Extra ties, cut from wood and stained or painted dark brown or black, improve the appearance of tinsplate track. One manufacturer makes flexible O-gauge tinsplate track in 3' lengths mounted on closely spaced wood ties. It can be curved and will mate with regular tinsplate track and switches. The center third rail on O-gauge tinsplate can be made less conspicuous by painting its flange and sides—but not the top, of course—the same color as the roadbed.

How many rails? For complete realism, many hobbyists prefer a two-rail system. In this, the running rails are insulated from each other. Both serve as conductors. Current flows into the wheels on one side, through the motor and out through the wheels on the other side.

Converting O-gauge tinsplate to two-rail, however, is costly and complicated. It's probably wiser to start with what you have, and use ingenuity to make the most of it.

Don't stop with tracks and scenery. Houses and railway structures can be bought in kit form at hobby shops—also scale trees, shrubs, fences and farm animals.

Next step: DC. Once you get going, you may want to convert to direct-current operation. This will give you instant, positive reversing instead of the seesaw operation common to alternating-current reversing. You will know before turning on power which way the engine is going to run and so will be able to move the trains realistically.

For direct current, you must add a rectifier to your transformer. Ask your hobby dealer for one that will handle the maximum voltage and output (in watts) of your transformer. You can use the old speed control on the transformer, but will need an extra double-pole, double-throw switch. This controls train direction by reversing the polarity of the track.

You will also need a small rectifier for each locomotive. It must be connected across the field winding of the motor so as to keep current flowing the same way in the field even when you reverse it in the armature. Then the motor runs the other way. Let an experienced model fan help you with this unless you know your engine and can get instructions for wiring the rectifier.

No track changes are necessary, and you'll find that on DC your engines start in a slower, more realistic way and can pull heavier loads.

Rolling stock. You can add greater realism to your tinsplate layout by getting scale freight cars and putting on tinsplate trucks. Kits can be bought with either kind of trucks. They come in a larger variety of



IT'S A SMALL WORLD, but this corner of Henry Abraham's scale layout shows how real it can look. Trap doors like one he's standing in give access to any part of system. His loco-

motives run on direct current. Transformers and rectifiers that supply power are housed in a ventilated case just under switch-studded control panel shown below.

car types than the non-scale ready-mades, and, because you put them together yourself, are cheaper. Don't, however, buy scale engines or passenger cars for tinsplate track, as these are too long for the short-radius curves and their small wheel flanges will not hold the rails.

If you ever want to convert to two-rail scale track, you can adapt both the scale stock and your original tinsplate cars by simply substituting scale trucks. To convert your engine, though, you'll have to turn down the wheel flanges. Unless you have a lathe and experience, better leave this job to your hobby dealer.

Pointers that pay. Twelve years of this hobby have taught me some things the hard way:

- Don't use bell wire for connections. The covering unwinds, causing shorts. Use No. 16 or 18 rubber-covered stranded wire.
- Solder connections whenever possible, especially those to clip-on (Fahnestock) terminals. Then you won't have to track down open circuits.
- Solder track joints, too, once you are sure the layout is permanent. This will insure good electrical continuity.
- Build your control board on a plywood panel separate from the layout. Then it can easily be altered when you make changes—as you undoubtedly will.

These are just suggestions. One of the pleasures of model railroading is that your system develops just the way you want it to. You're the boss—so go to it! END

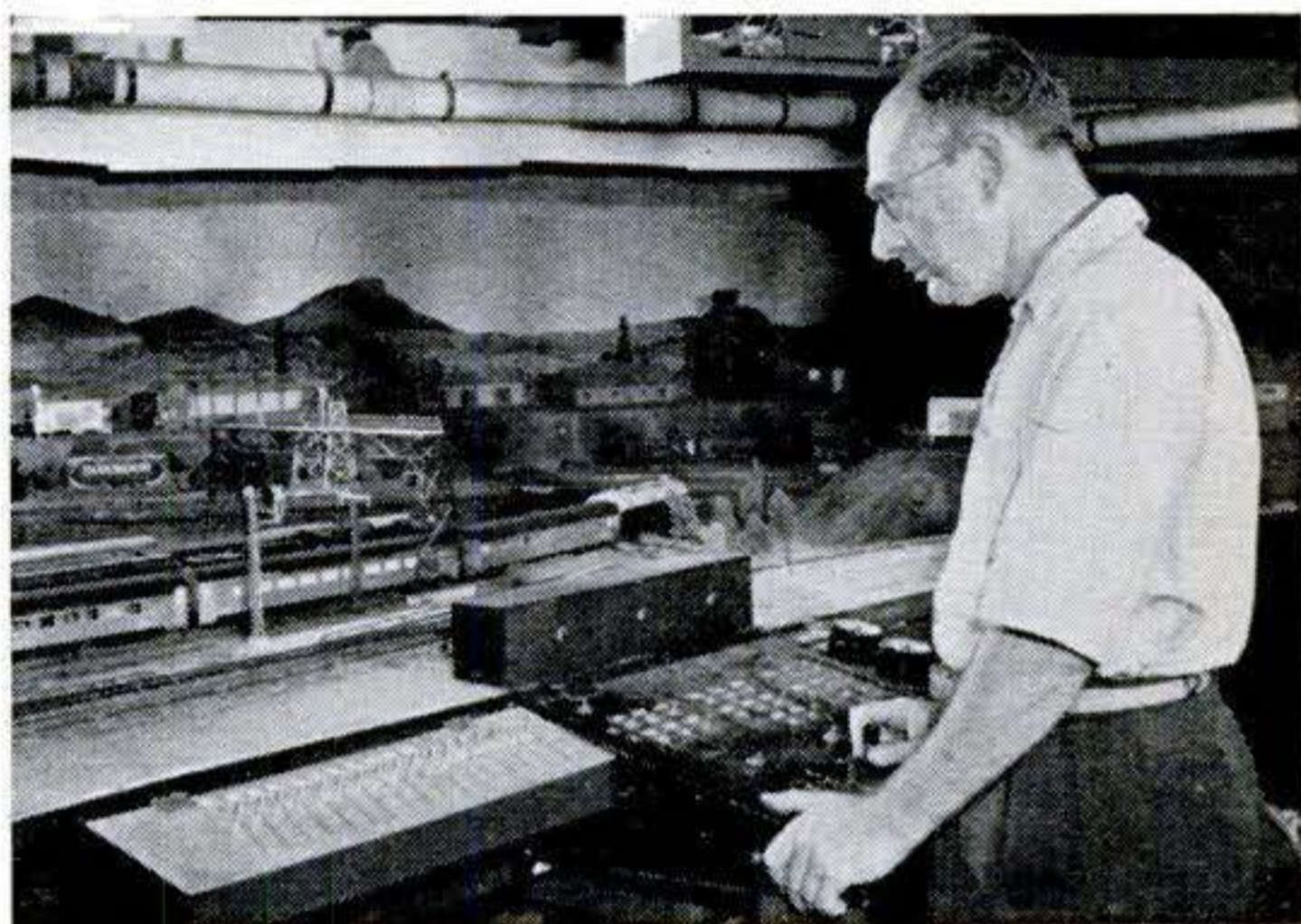

About the Author

HENRY ABRAHAM, an insurance agent, didn't dream what he was starting when he moved the kids' trains into the cellar. In 12 years, the layout, converted to scale, grew to 30' by 45'.

Being civic minded, Abraham makes his hobby serve the community. Boys from the neighborhood Police Athletic League and Boy Scouts are weekly visitors. Since 1942 he has put on a yearly show that packs in adults as well as youngsters. Receipts from a 10-cent admission go to the Red Cross. In 1951 they totaled \$350.

The payment Abraham received for this article went to make a long-cherished dream come true. He traveled 3,600 miles—by train—to visit a model pike even bigger than his.

Venetian-Blind Slats Catch the Drips

DRIPPING water from condensation on the cold-water pipes in my basement was endangering equipment stored under the pipes. I solved the problem by making use of leftover metal Venetian-blind slats. Splicing together the curved slats with tape, I formed a trough to catch the drips. I hung it beneath the pipes at a slight pitch and any water that fails to evaporate is drained off into a receptacle at the end of the trough.—A. O. Schwarz, Hanover, N. J.

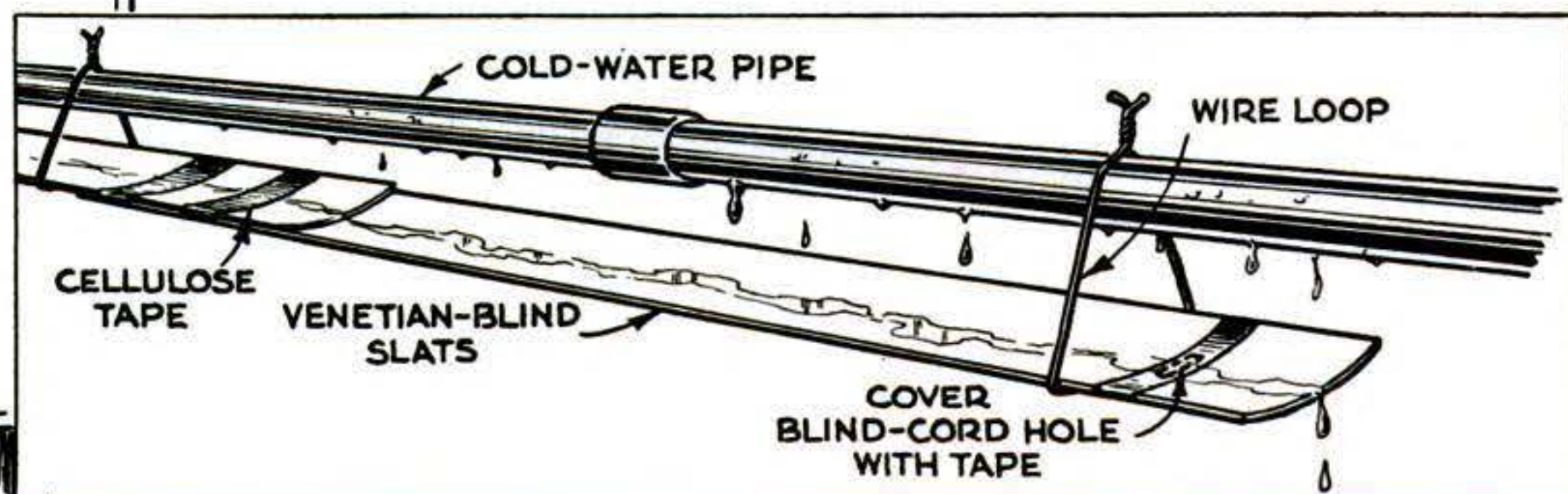
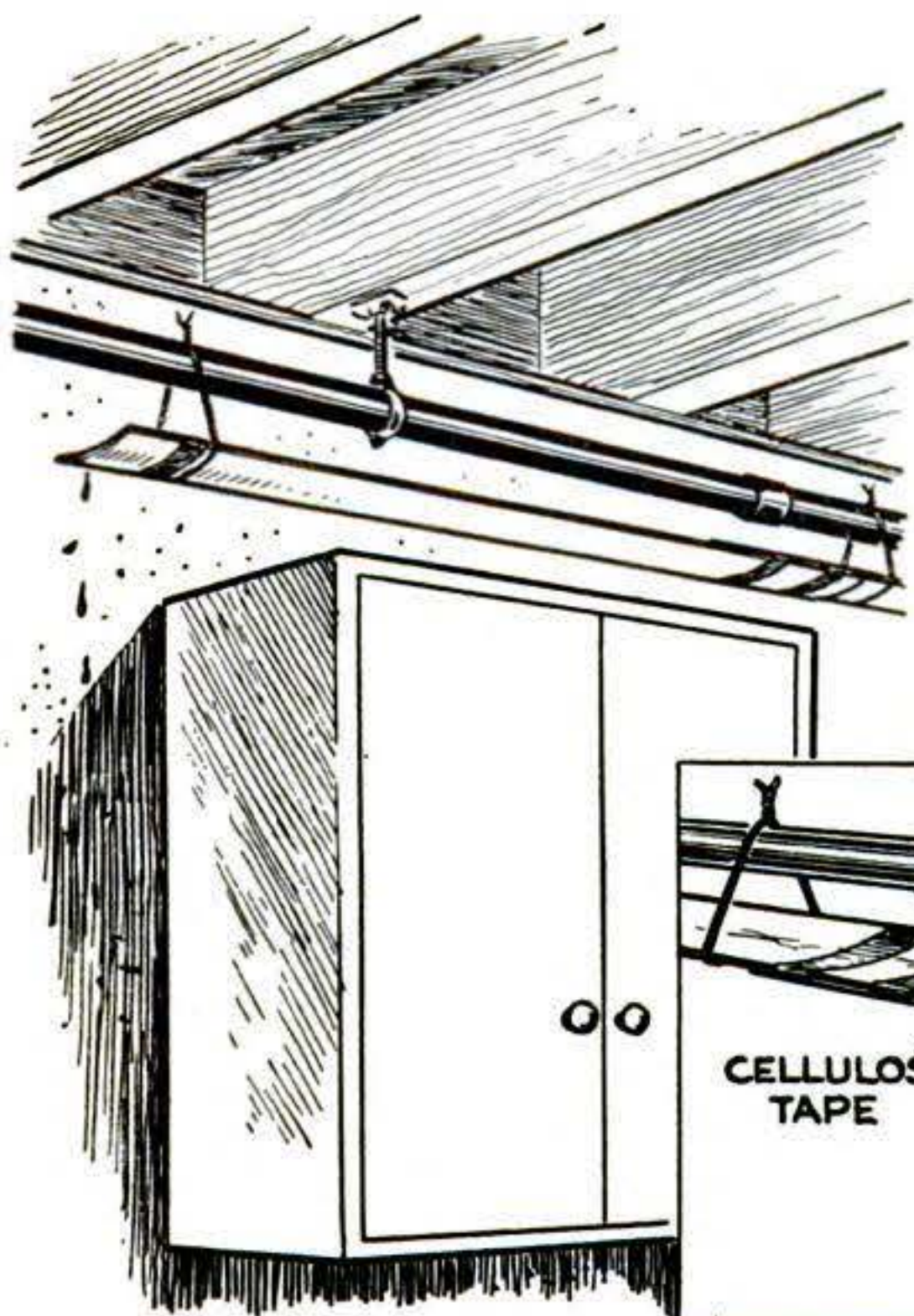
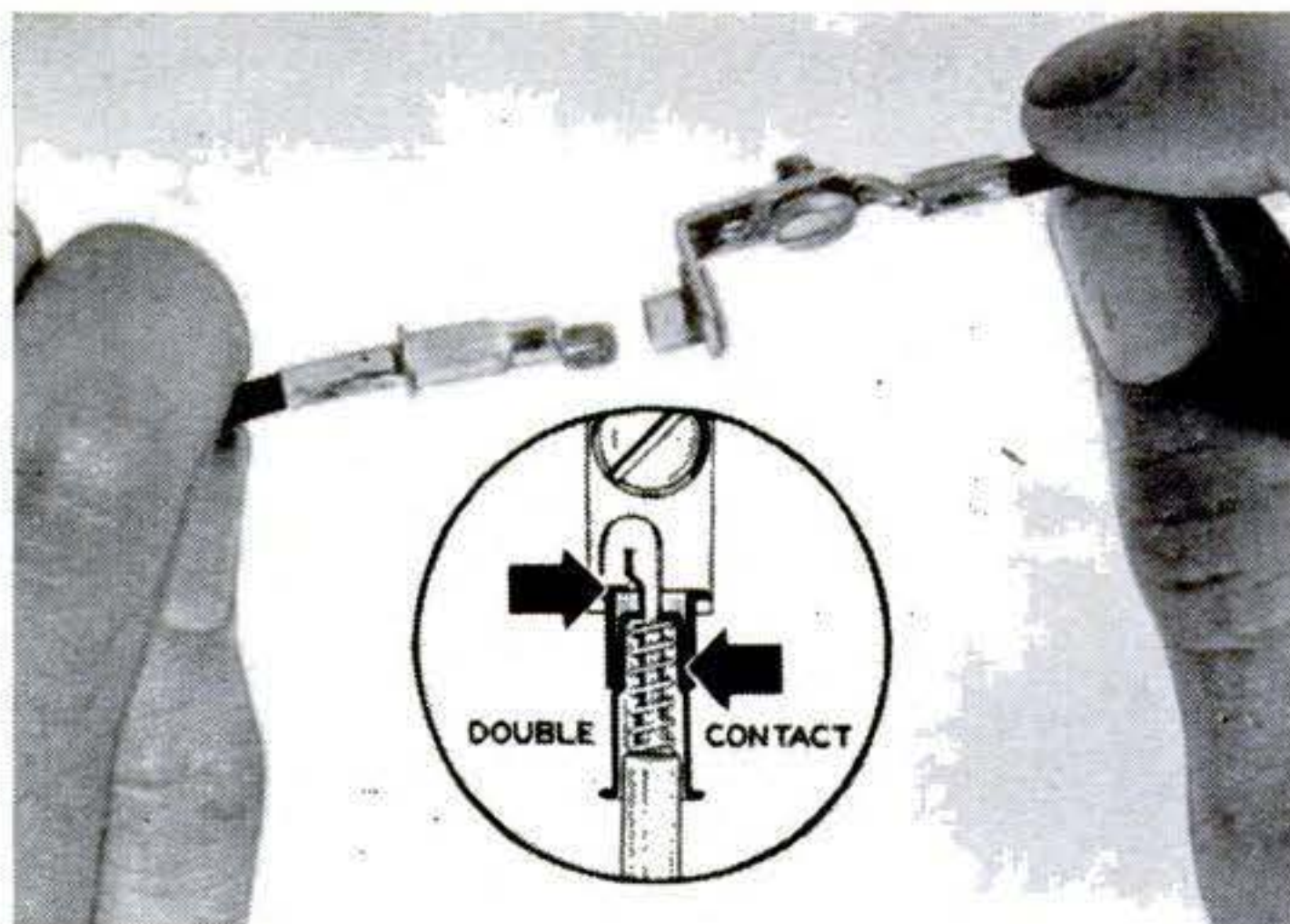

Photo Meter Is Matchbox Size

ONE of the smallest exposure meters made in the U. S., the new Mascot pictured below has four lens-opening or f-number scales. Each scale is pegged to a different film-speed index number—5, 10, 16 or 50—and gives a direct reading of the correct f number for use with 1/25-second shutter speed. If you want to use a different shutter speed or your camera is loaded with film having a speed not included on the rotating scale, you consult an accompanying chart to determine which scale to use. Made by GE, it is priced at \$16.95.



Spring Locks Wire Connector



CONNECTING or separating two wires is easy with this new plug. Its tip hooks over a collar in the socket made to be used with it, and holds the plug firmly in place until a light tug on the spring-loaded flange centers the hook and thus lets it slip out. The makers, Harvey Hubbell, Inc., Bridgeport, Conn., also use these connectors on key chains.

Shingles Help You Hang a Door

WHEN you hang a door, cedar shingles will wedge it above the sill so that it'll swing freely after the hinges are fastened. Draw lines across the shingles just where they're thick enough to lift the door for proper clearance. Tap the shingles under the bottom edge of the door until the pencil lines disappear. To plumb the door, use shingles at each side.—J. R. E. Cameron, Vaucroft Beach, B. C.



Tune Your TV Set from Across the Room

You pick programs by remote control with this simple armchair tuner that fits most receivers.

By Alan W. Baldwin

YOU can really lean back and enjoy the TV shows when you don't have to keep getting up to change stations. This remote-control tuner lets you switch channels and adjust volume and contrast without stirring from your easy chair.

The parts for such a convenient device can be bought for less than \$10. It can be

fitted to a large number of receivers now in use. Since it changes channels mechanically, there's no danger of upsetting delicate electronic adjustments.

How it works. A small motor and three gears, which you install right on the TV chassis, turn the station-selector switch. They do mechanically exactly what you now do by hand. Two potentiometers wired across two controls in the receiver provide remote control of contrast and volume.

These are the essential parts of the remote control. They are shown in their simplest form in the photo-diagram of the

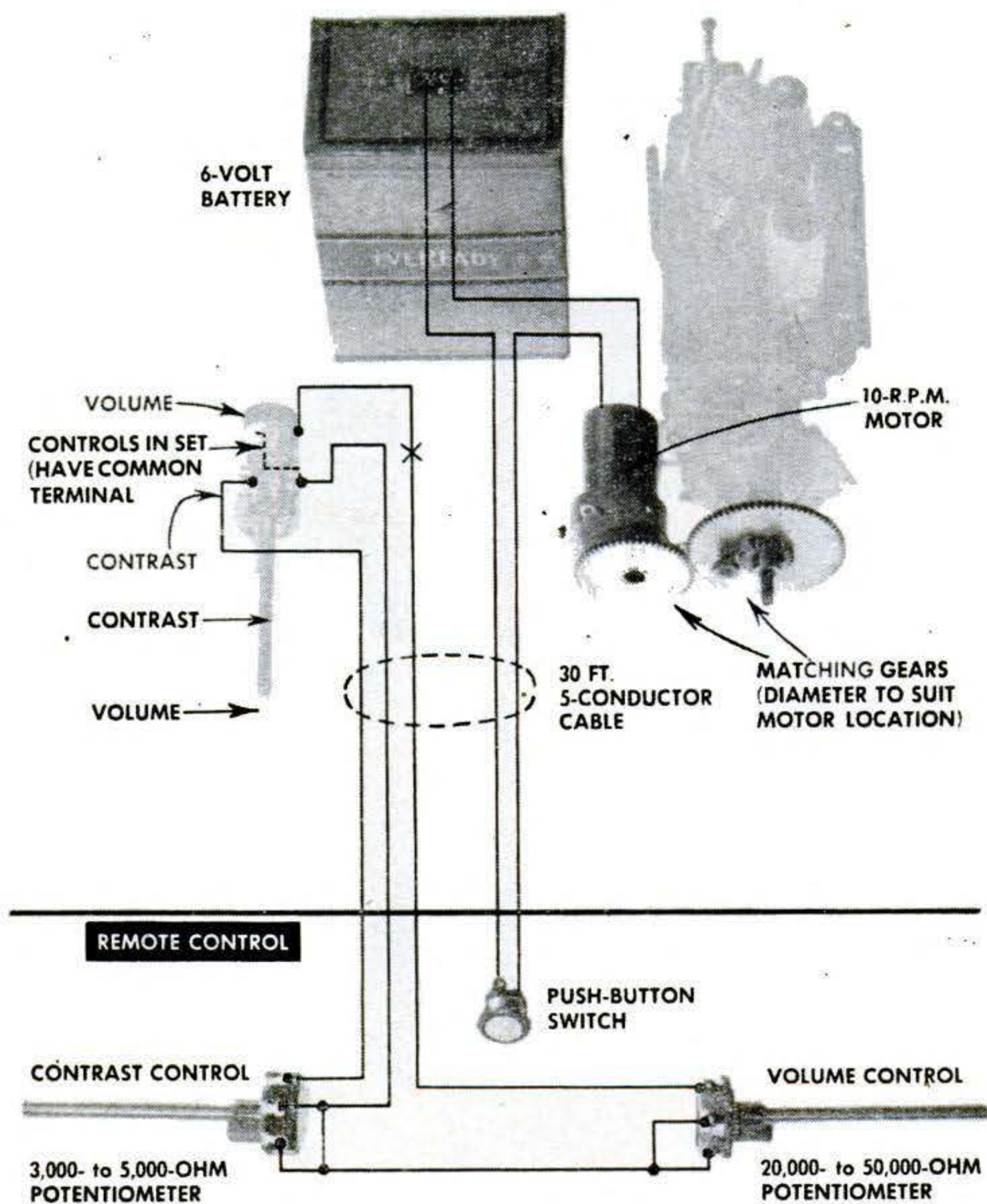

TWO CONTROLS and a button are in the simple remote tuner shown in photo-diagram at left. Control unit, at bottom, is connected to the set by a five-wire cable. The shadowed parts at top are already in the receiver; the battery, motor and gears must be added.

You can tuck the battery anywhere in or behind the TV cabinet, but it's best to mount the motor in line with the station selector so you can gear the shafts together as shown on a following page.

Volume and contrast potentiometers in the set may be separate, but more commonly they are combined in a dual control as shown here. Usually they have a common connection. Wire the common (negative) side to both remote potentiometers, and connect the positive terminals to corresponding lugs on the remote units. Do not disturb or remove any wiring in the receiver.

battery-powered control pictured above. The slightly more elaborate version on the next page also has a remote on-off switch and a different power supply for the motor.

Planning the installation. Since tele-sets differ widely, you have to fit the remote control device to your set. Begin by checking the receiver on these points:

1. Does the station switch operate on the *sleeve* or the *shaft* of the set's tuning assembly? Most sets have two concentric tuning controls—one for station switching, the other for fine tuning. Either sleeve-switching or shaft-switching sets can be adapted, but the rig is a bit different.

2. The channel selector should have definite stops, clicking into place when you tune the set remotely. If the switch detents are sloppy or loose, adjust them for easy but positive action.

3. Find suitable space for the motor. In the installations pictured, the motor is mounted along-side the tuning assembly and

geared directly to the station selector. If your set does not permit this, mount the motor where you can and turn the switch with sprockets and a small ladder chain.

Though the remote control will work on most sets, there are some with which it cannot be used. The station switch on the receiver must be able to move continuously in one direction, because the motor and gears turn only one way. And since this control has no provision for fine tuning, it should not be used on a set that needs frequent fine tuning. If your set does, have it carefully aligned before making this tuner.

Selecting the parts. The motor you buy should have an internal reduction gear. It must have enough torque to turn the selector switch. If you can stop the motor with your fingers, it probably is not husky enough. It should be geared to about 10 r.p.m. to change stations at a comfortable, controllable speed. Suitable six- to 12-volt midget DC motors are available.

AN ON-OFF SWITCH can be added to the unit shown on the previous page, and the battery replaced by a transformer and rectifier. Seven conductors go to this remote unit (you may find standard eight-wire cable easier to obtain).

Break one of the two connections to the on-off switch in the receiver and reconnect the cut ends through the switch on the remote volume control. This puts the local and remote switches in series so either one turns the set off. But both must be on before the set will operate.

Mount the transformer in any convenient space on or under the chassis; locate rectifier where it will get some ventilation. If a six-volt transformer does not deliver enough power through the rectifier to drive the motor, connect a 50-mfd., 25-volt electrolytic condenser as shown by the dotted lines, or use a 12-volt transformer.

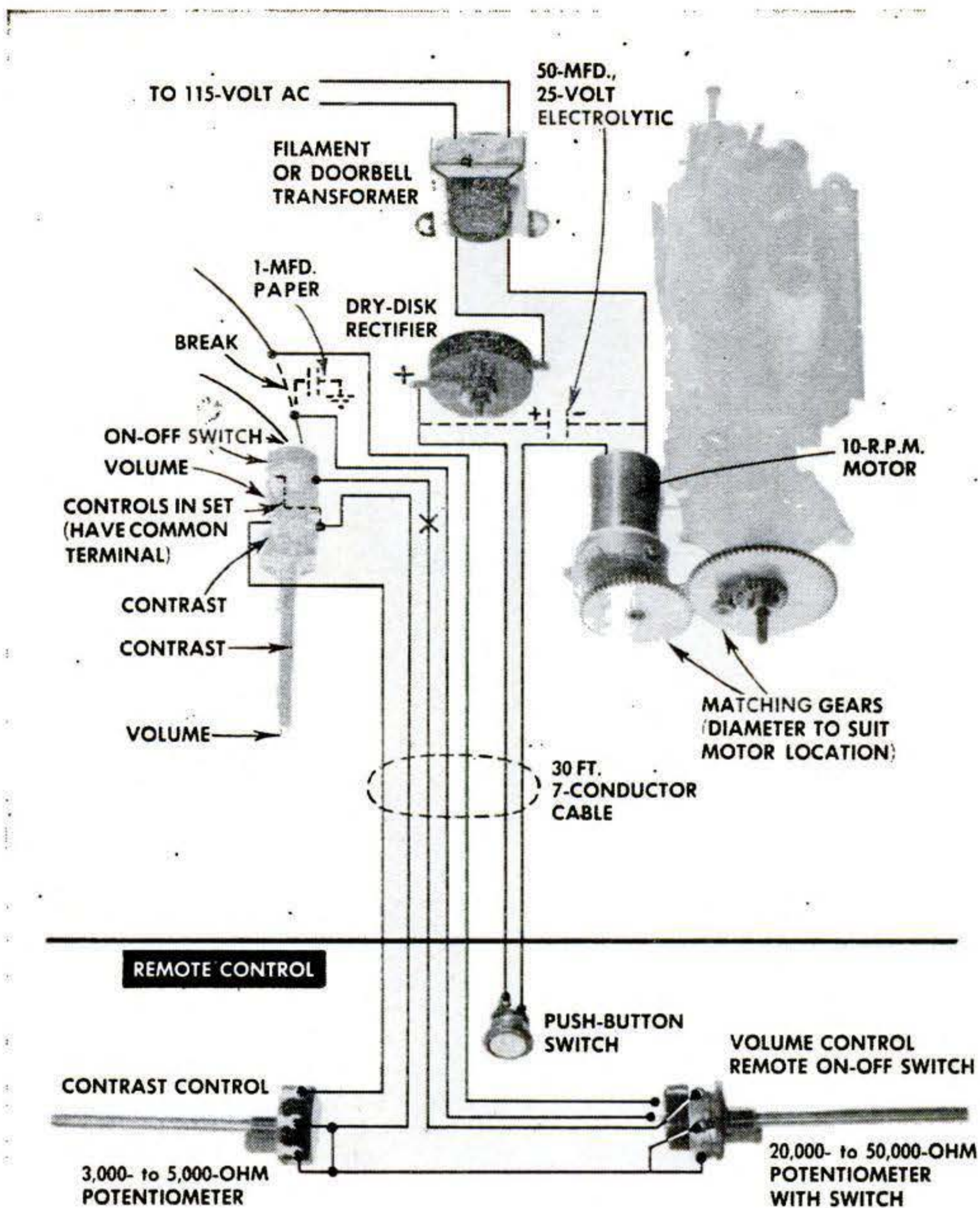

Since the motor draws current only while it is actually changing stations, a husky battery will last a long while. If you would rather do a little extra work now to avoid battery replacement, use a transformer and rectifier instead. A suitable dry-disk rectifier in combination with one or more filament or doorbell transformers can be picked up at many radio-parts stores. Before you actually install the power-supply parts, make sure they work with your motor.

The remote potentiometers are not critical, and here, too, you have a lot of leeway in selecting them. Relatively low resistances are specified to reduce tendency for hum pickup. Low resistance, however, may also reduce signal strength. If you find that volume drops off too much, use a higher resistance for the remote volume control. And if the remote contrast control does not provide enough range, substitute a higher value for it.

If excessive hum develops, insert a

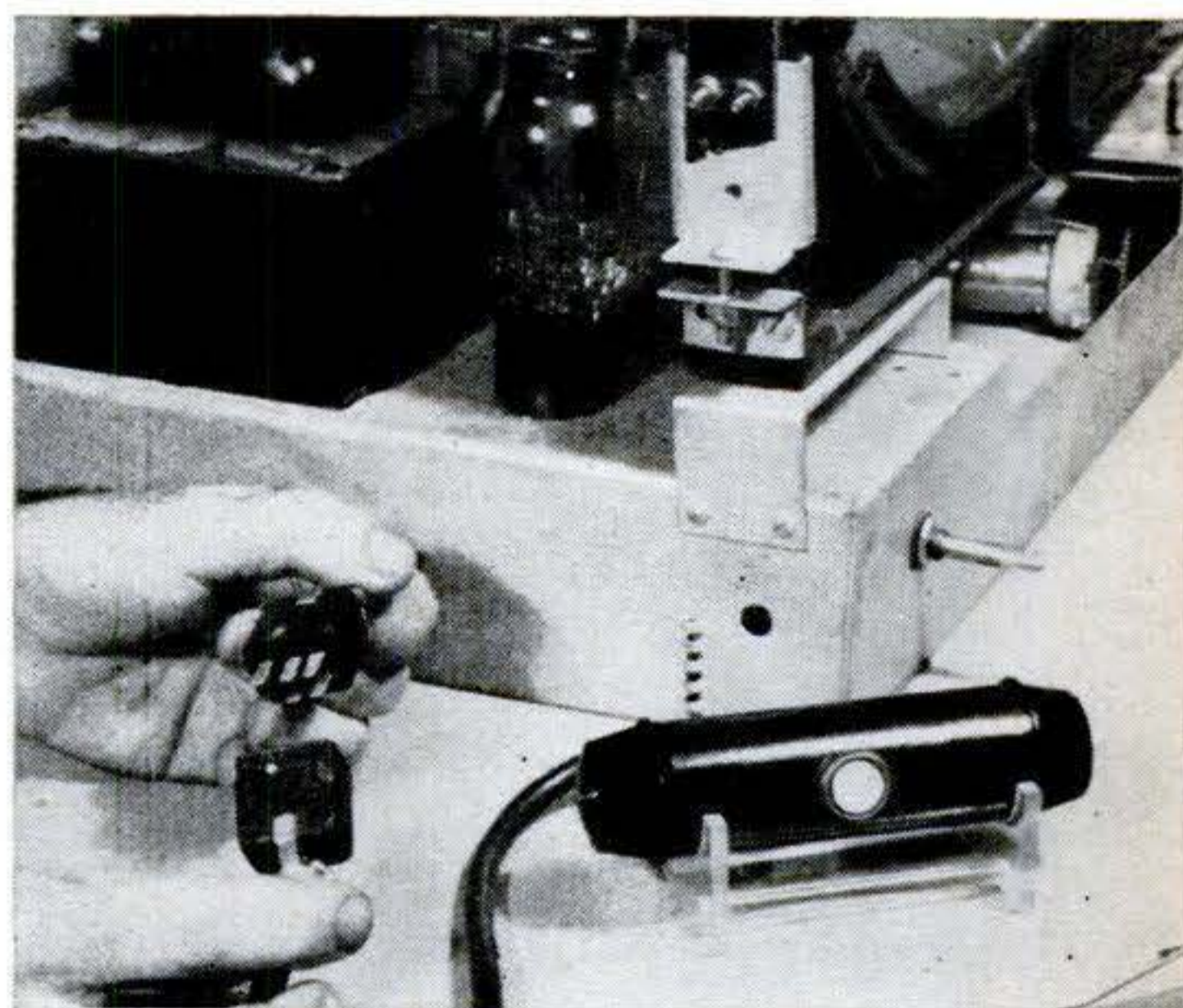

PLUG-AND-SOCKET CONNECTORS to permit removal of the remote unit are handy but not necessary. If your armchair tuner includes a series-wired on-off switch, install an extra switch on the chassis to close the power circuit when the remote tuner is unplugged. Other circuits remain the same. A hollow plastic cylinder, just big enough to take the pots, makes a neat housing for the unit.

How to Gear the Motor to the Station Selector

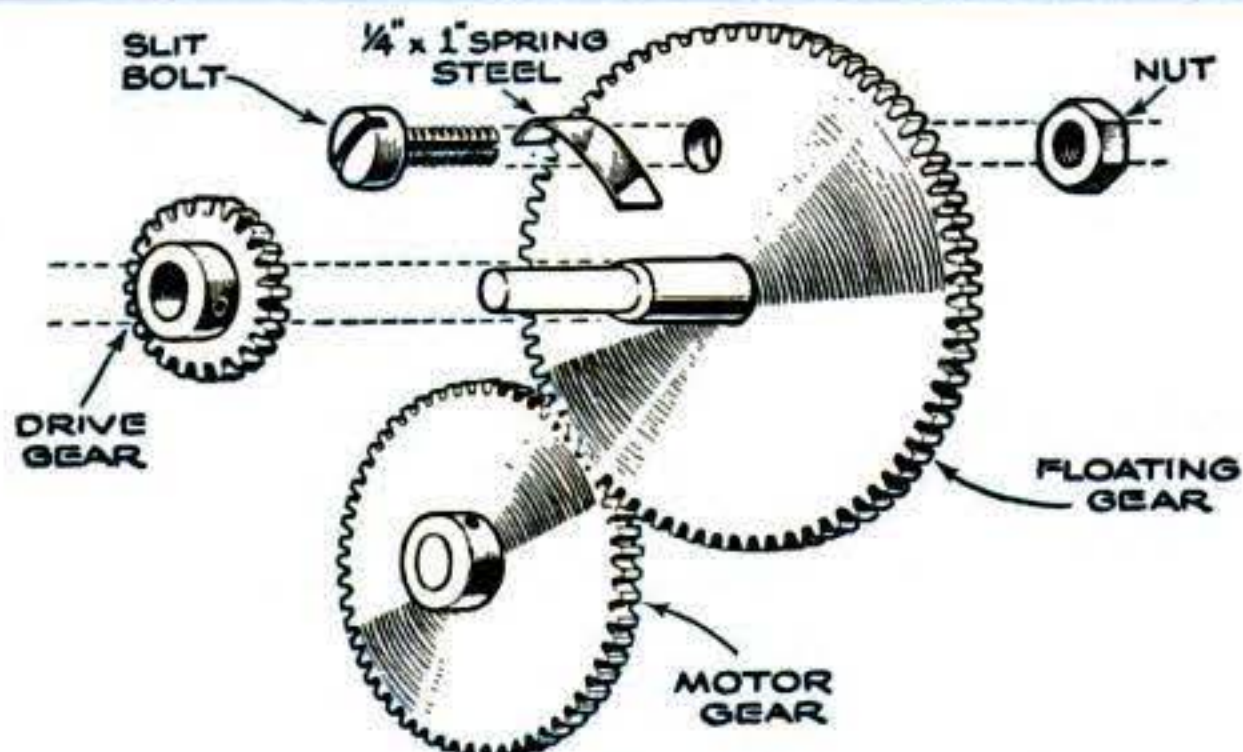
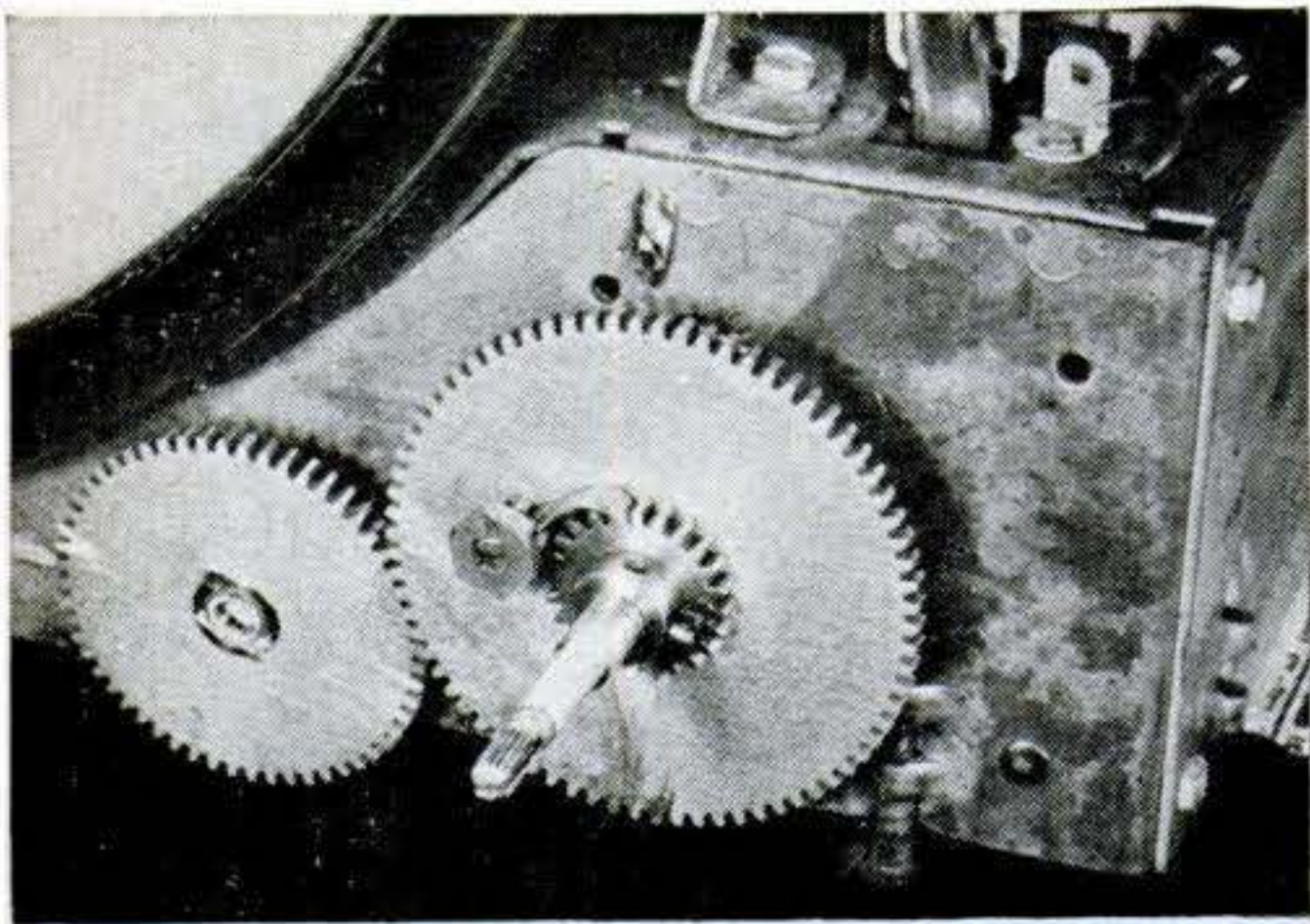

IF THE SLEEVE of the tuning assembly turns the station-selector switch, the tuning motor can be geared this way. Gear diameter is governed by the location of the motor. All gears should have matching teeth. The large gear is a free fit on the tuner sleeve; drive and motor gears are fastened with setscrews. The motor turns the drive gear through a clock-spring ratchet. This arrangement permits manual tuning in the direction of the ratchet.

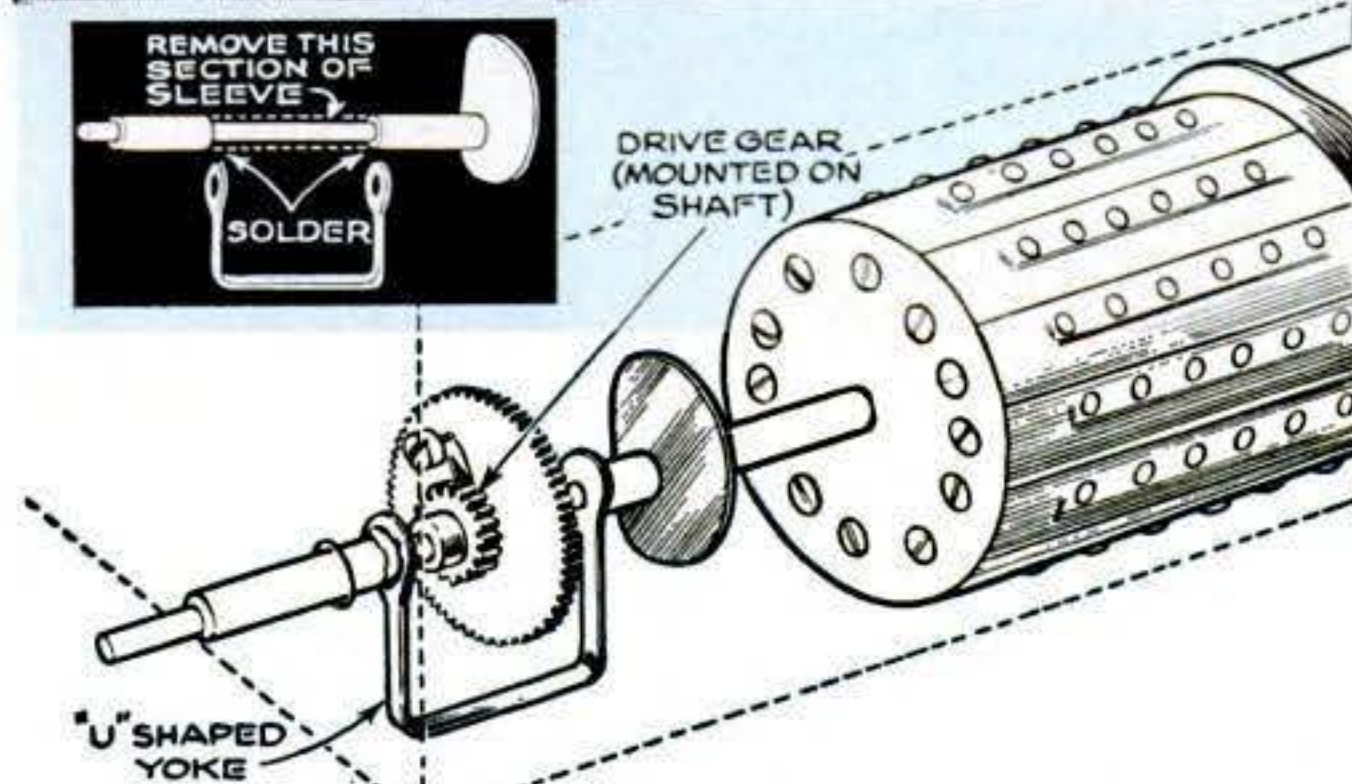
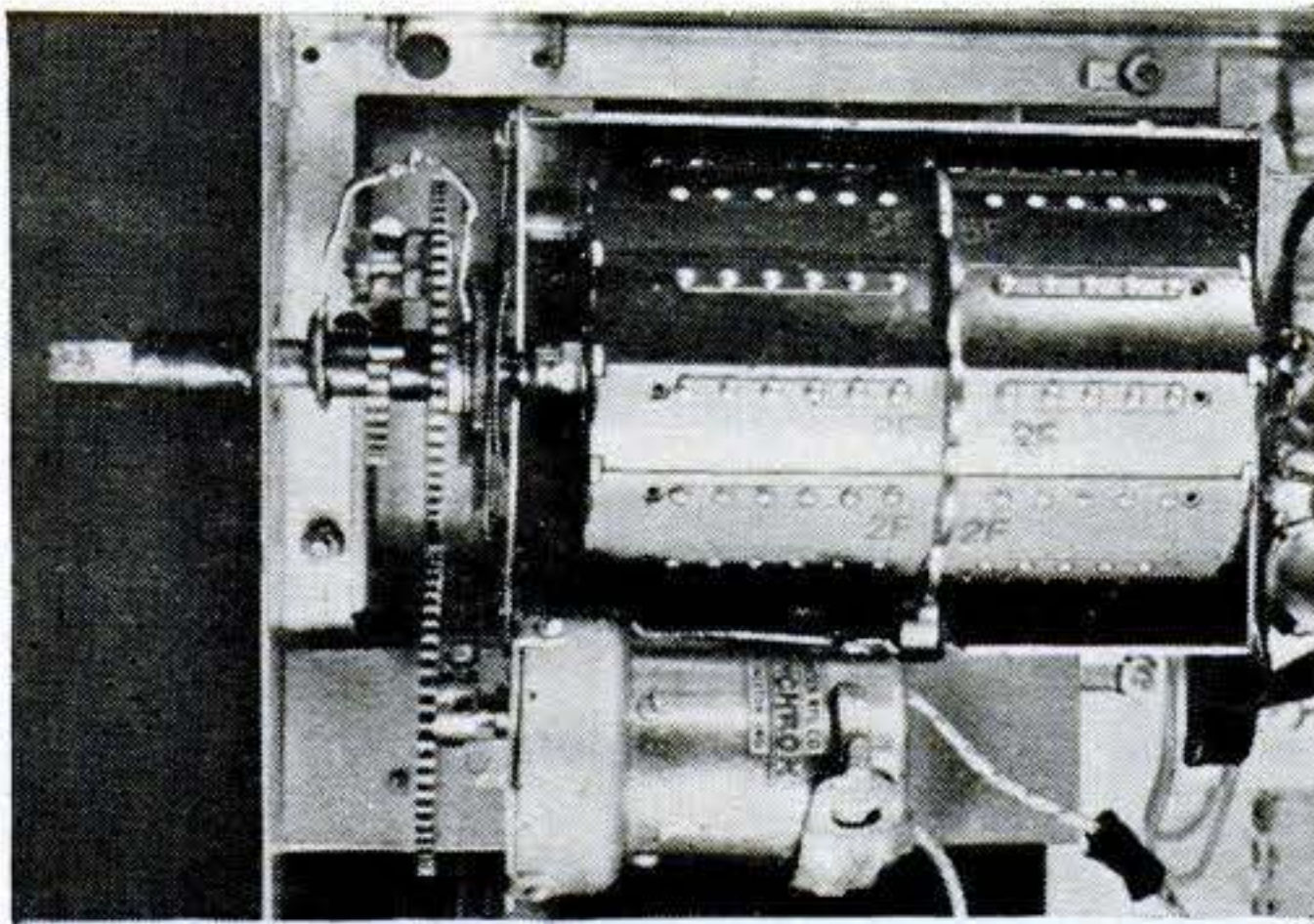

IF THE SHAFT of the tuning assembly turns the station-selector switch, part of the fine-tuning sleeve must be cut away. Soldering a U-shaped yoke to the cut ends restores manual control of the fine tuning. Other details are the same as those shown at the left. A gear ratio of about 2 to 1 provides satisfactory tuning speed with a 10-r.p.m. motor. If the motor turns the wrong way, reverse the two connections that go to it.

.1-mfd., 400-volt paper condenser in the remote volume-control lead at the point marked X in the photo-diagrams. And if you hear a whistling or "rushing" sound, connect a .01-mfd., 400-volt paper condenser across the two outer terminals of the contrast control in the set.

The two 115-volt leads required for a remote on-off switch may introduce some hum. To overcome it, ground one switch terminal through a 1-mfd., 200-volt paper condenser as shown by the dotted line.

Operating the remote control. The volume and contrast controls in the arm-chair tuner govern the same circuits as those in the receiver. To keep the two pairs of controls from limiting each other, set the ones that *are not being used* to maximum.

When you press the push button on the remote control, the motor turns the station-selector switch. After you have worked it a few times to get the feel and timing, you will find it a cinch to pick out a station as the channels march around. END

Probe Adapts Meters for High-Voltage TV Tests



THIS high-voltage probe can extend the range of most vacuum-tube voltmeters and multimeters to 30,000 volts. Resistors in the probe can be interchanged to adapt it for use with almost any meter having a sensitivity of 5,000 ohms per volt or more. Precise Development Corp., Oceanside, N.Y., makes the probe.

Offset Stairs Save Space

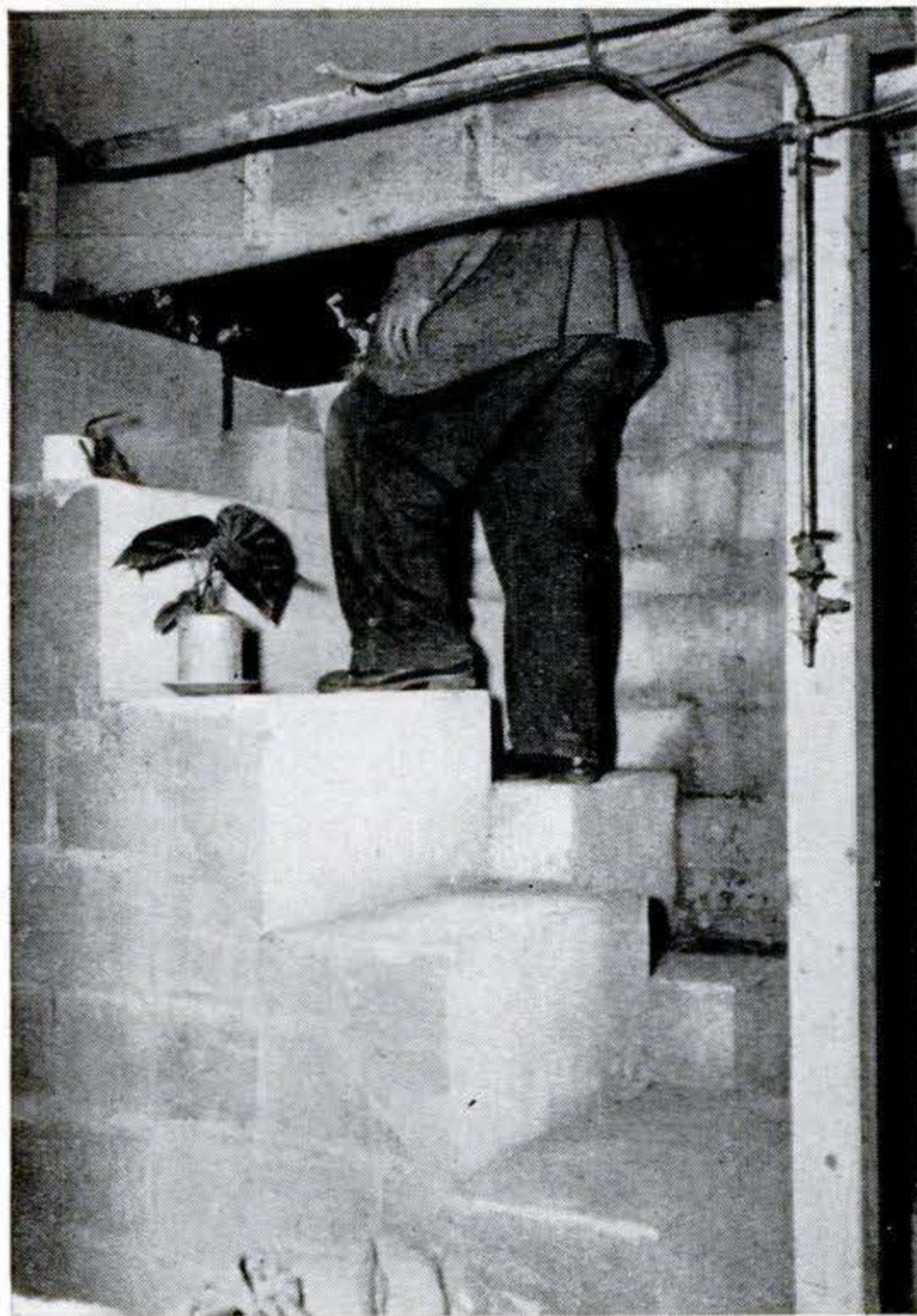

OFFSET stairs like these, made of surfaced concrete blocks, are fine if you remember to start up or down with the correct foot. Where space is lacking to build stairs of normal rise and tread, offsetting them reduces the length of run, yet gives normal tread on each step.—*Stephen Greene, West Dover, Vt.*

Corner Brace for Furniture

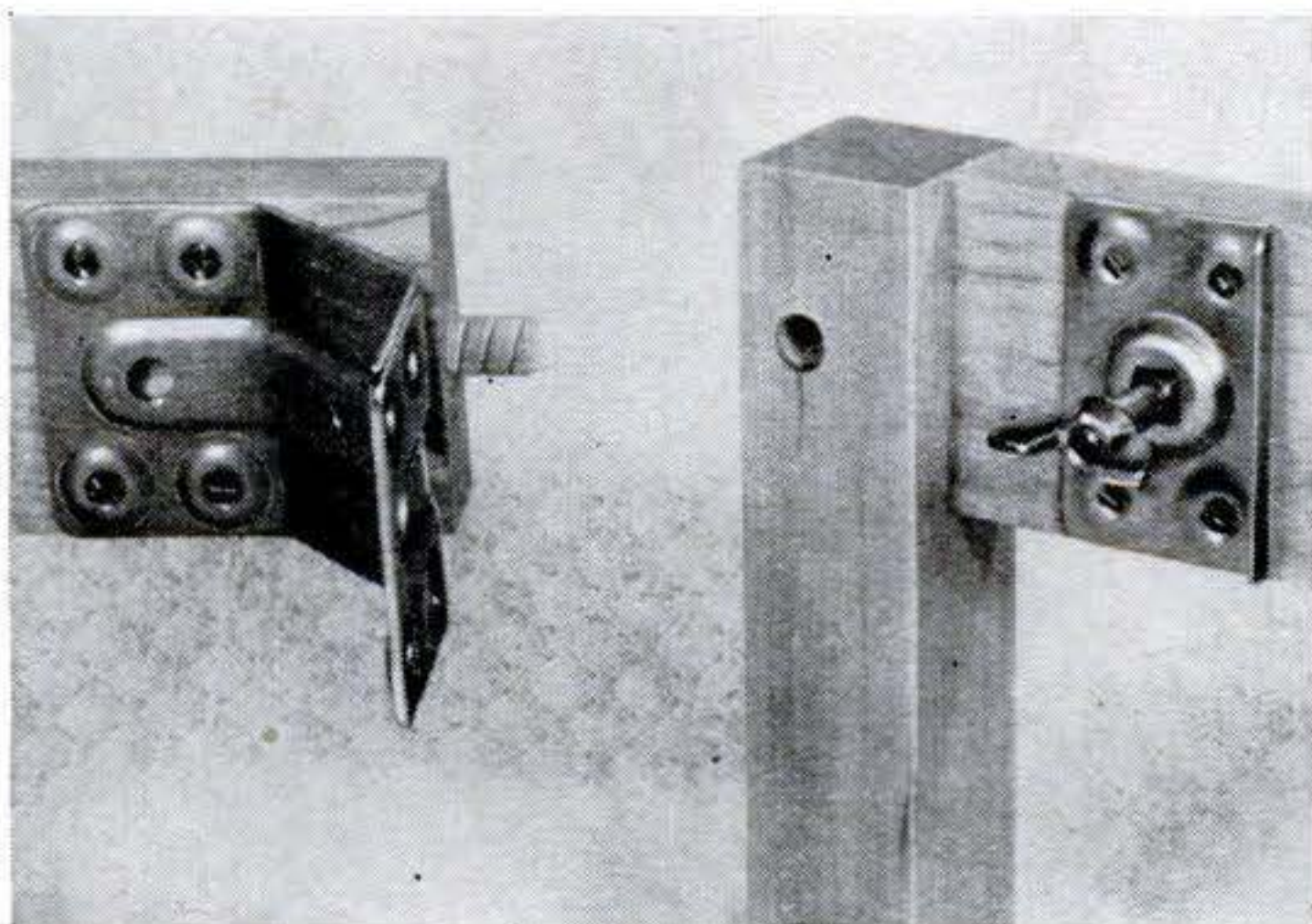

THIS corner brace, designed for wooden bedframes, can be used on chairs, tables and other pieces of furniture. Once it is installed, no tools are needed for assembly or disassembly. The wing nut and bolt hold the parts rigidly. Rudolph Industries, Holland, Mich., is the maker.

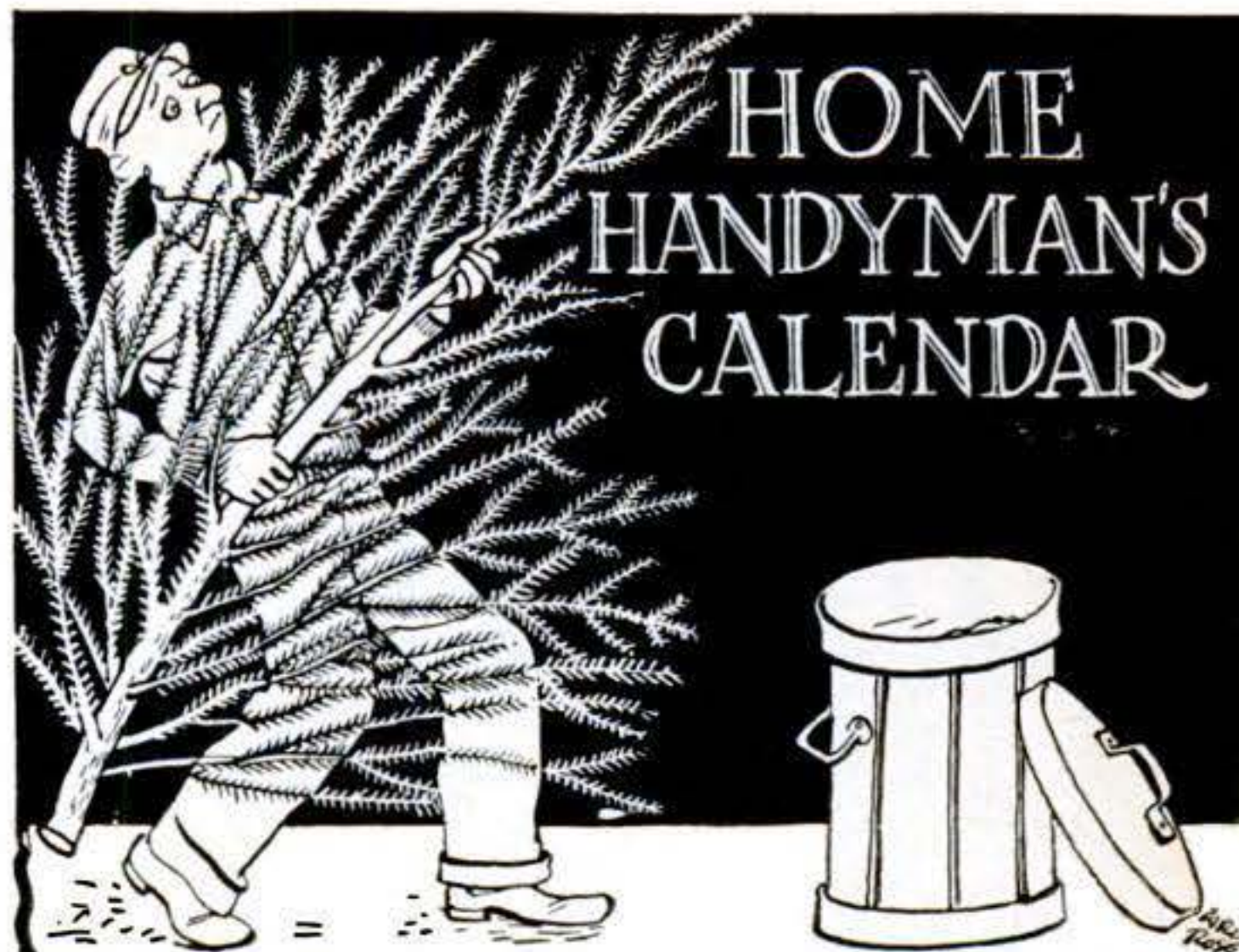

January This chill winter month of brave new resolutions may well be dedicated to indoor chores.

- Have you disposed of that dried-out Christmas tree? While you're at it, search out other trash, rubbish, oil-soaked rags, anything that might be a fire hazard.
- Check the wiring of lamps and appliances; replace worn cords and broken parts. Oil electric motors and squeaky hinges. Repair any broken locks, latches and bolts. Tighten loose doorknobs.
- Drain and refill the steam boiler. Inspect the hot-water tanks and pipes. Rust and dripping faucets are always signs of plumbing trouble to come.
- More time to spare? Why not build some extra shelves? These you always need. You can finish attic rooms or build a basement rumpus room, ignoring winter winds outside.
- There's one outside chore you mustn't overlook. Remove ice and snow from roofs and gutters before the load gets dangerously heavy. A sudden change in weather may cause extensive damage if this is neglected. Also, if you'll be needing new fences or rustic furniture, now is the time to cut your posts and poles. There's less checking and cracking in winter-seasoned wood.



How an Expert Soups a Stock V-8

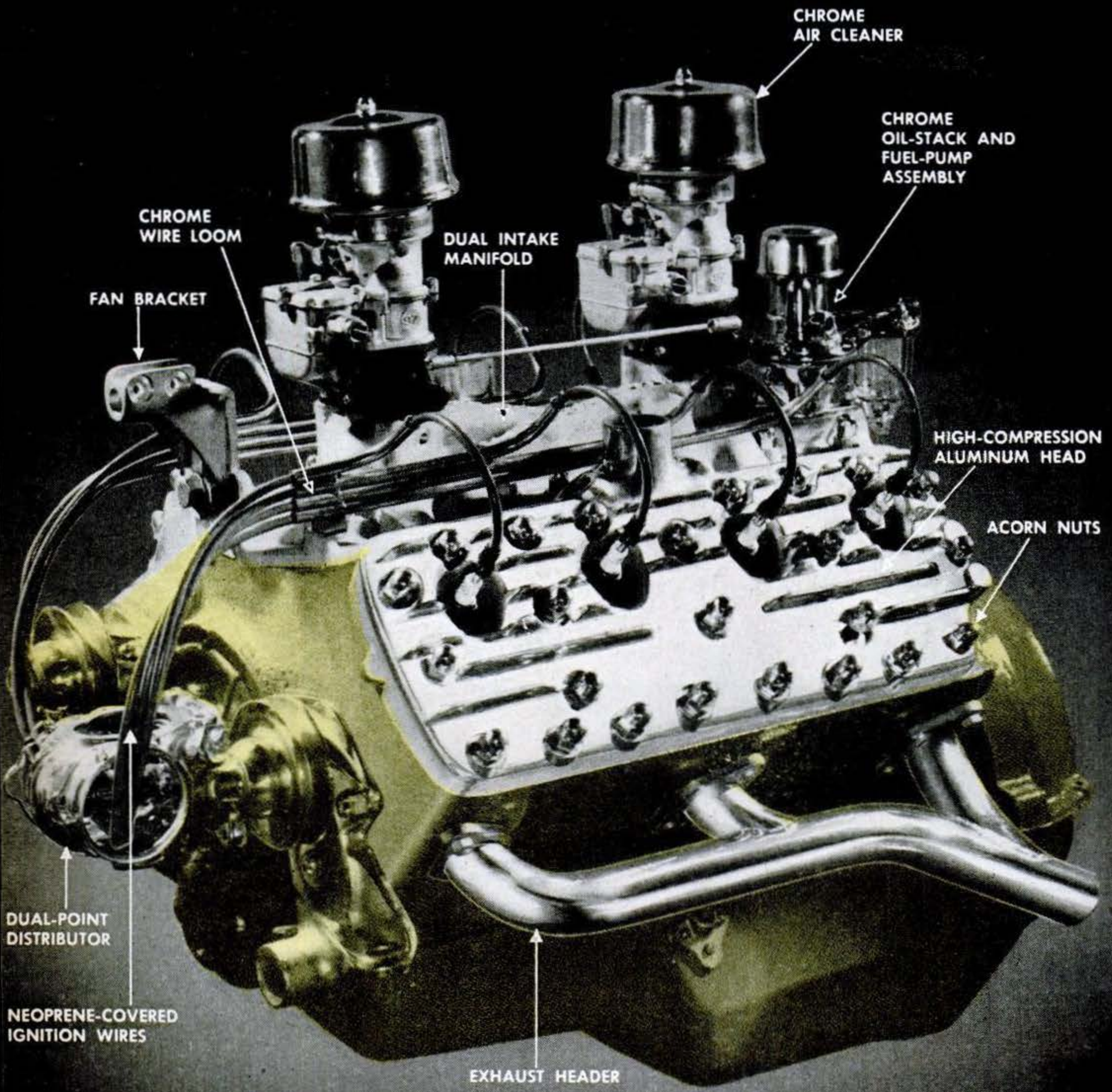

A few of the many souping accessories made for a V-8. Standard caps go on the distributor.

**A racing driver tells you how
\$250 worth of work and accessories
can nearly double a V-8's power.**

By James Pauley

PACKING new horses under the hood is a large part of my business. The work I do runs all the way from conservative souping—which gives the Detroit product a bit more sass—to a full-dress hop-up, which can double the brake horsepower delivered to the transmission.



JAMES PAULEY

People sometimes wonder why Detroit doesn't build in this extra power, especially since any good mechanic can do the job without difficulty. The answer is that pure power is only one of many things the bulk of car buyers want. They also want quietness, dependability, smoothness at low speeds, high gas economy and a long run between overhauls.

They get these things, too. But when an engine is souped up, other characteristics necessarily slack off. While a slight boost in compression may improve gas mileage, a larger boost will make a car pretty choosy at the gas pumps. A racing camshaft will let an engine wind up far above its old peak r.p.m., but then it will run rough, buck and backfire at low speeds. And the greater stresses of high-output operation naturally shorten the time between overhauls.

This doesn't mean that boosting power is a short-sighted deal. You can juice up an engine so it will out-perform its brothers and still be quiet, reliable and eminently suited for trips to the grocery store.

In converting a car from stock to sports use, many enthusiasts work from the outside in. They install high-compression heads, twin carbs, and perhaps a set of dual mufflers. All these help to boost power, but that's only a start. To get the most out of an engine, you should work from the inside out (see "How 'Soupers' Pep Up Stock Engines," PS, Dec. '51, p. 189).

That way you get rid of basic defects that outside accessories couldn't overcome.

What engine to use. An L-head engine has definite souping limitations. For one thing, the shape of its combustion chamber makes the initial gas expansion take place

over the valves—instead of over the piston, where it belongs. For all-out power, double overhead cams and inclined overhead valves in a hemispherical chamber are the combination to dream about.

Still, you can do a lot with an L-head. The most popular souping block is a Ford V-8 of the 24-stud variety. This is the 85- or 95-hp. power plant built in 1939 and later. It's a good engine to work on because it has an excellent strength margin, a large-diameter crankshaft and insert-type bearings.

Some time ago I worked over one of the 85s. With a Mercury crankshaft, a bore of 3 3/16", a stroke of 4", a power cam and 8.5:1 compression with dual carbs, we got a dynamometer reading of 158 hp. at 4,600 r.p.m.—and that's a nice bit of stuff. Such a job might run around \$250, doing some of the work yourself.

Let me tell you how I would do it.

How to start. First, I would pull out the engine, take it down completely and wash off all sludge and grease. It pays to be almost surgically clean in engine work. Then I would inspect the crankshaft with care. If it was more than .0005" out of round or showed any score marks, I would have it reground. Naturally this would also mean buying new bearings to suit.

If I found any out-of-roundness in the cylinders, I would have the block rebored. But chances are I'd have it rebored anyway

A REGROUND CAMSHAFT and parts that go above it—adjustable tappets to compensate for metal ground from cam lobes, heavier springs to help reduce valve floating at high r.p.m., and a set of valves.

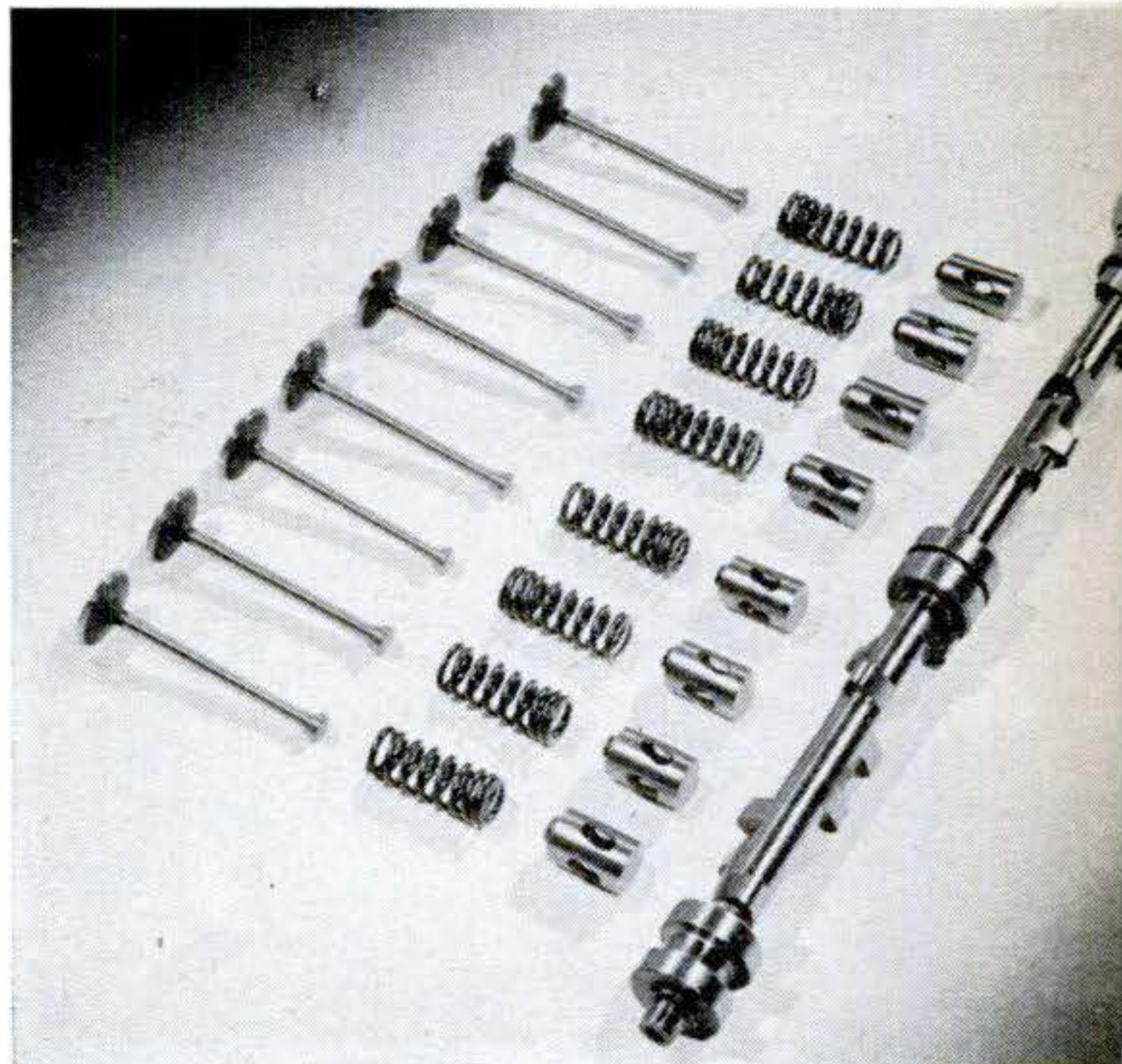

to increase the engine displacement. This costs from \$2 to \$5 a hole, depending on the shop. The 85-hp. Ford can be bored out to Mercury size, giving the engine an additional 18 cu. in.

For a full-scale job, I would also put in a 1949 Mercury crankshaft. This crank fits the older Ford models nicely and it has a $\frac{1}{4}$ " longer stroke—another way of increasing

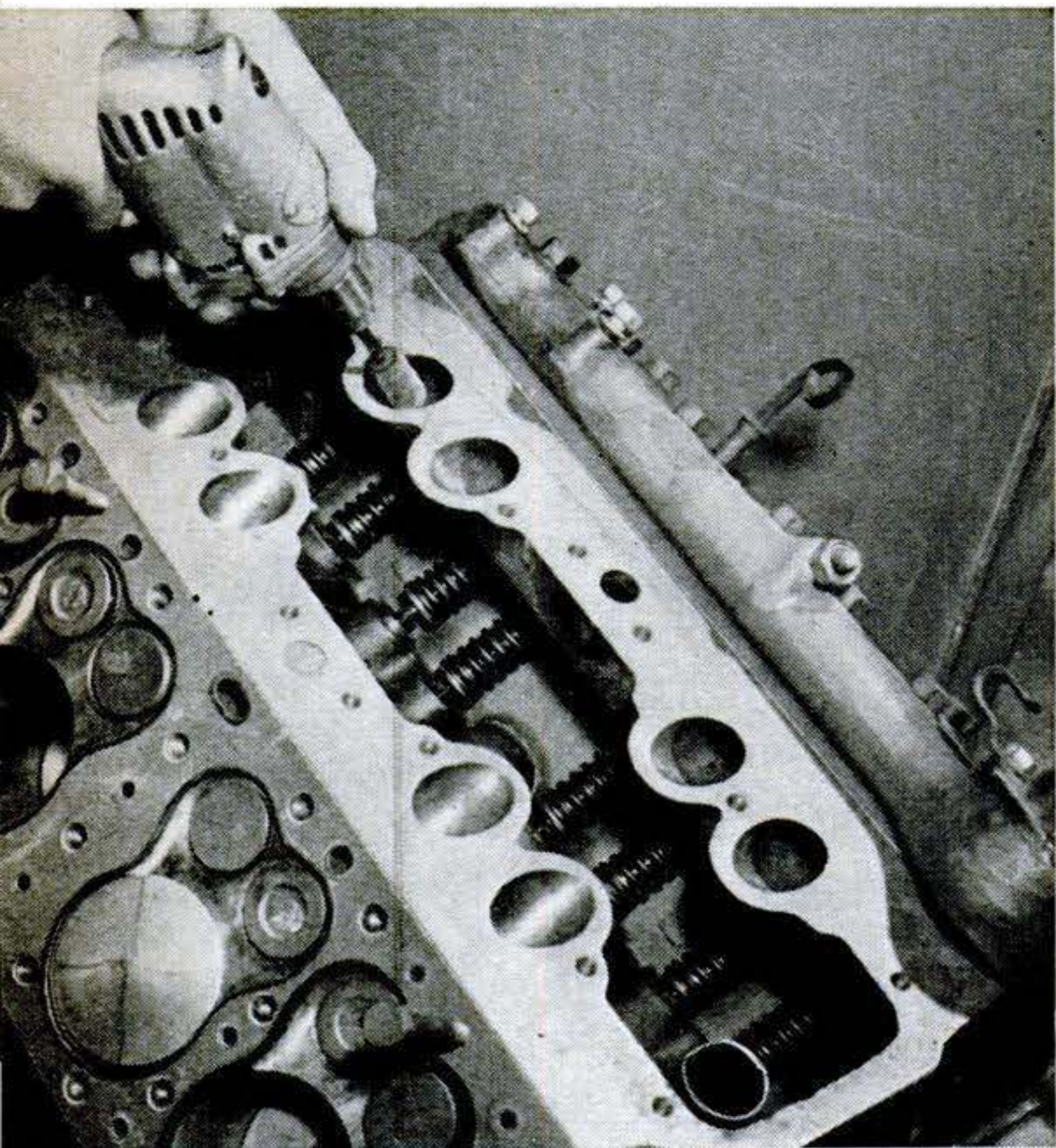

PORTING enlarges and smooths out the gas-flow path between manifold and cylinders. Metal is removed with a rotary file to straighten out the path as much as possible. Surfaces are smoothed with rubber abrasive wheel.

RELIEVING. In this process, you remove metal from top of block between the valve seats and cylinder bores. Object is to increase the gas-flow area between valve and cylinder. On

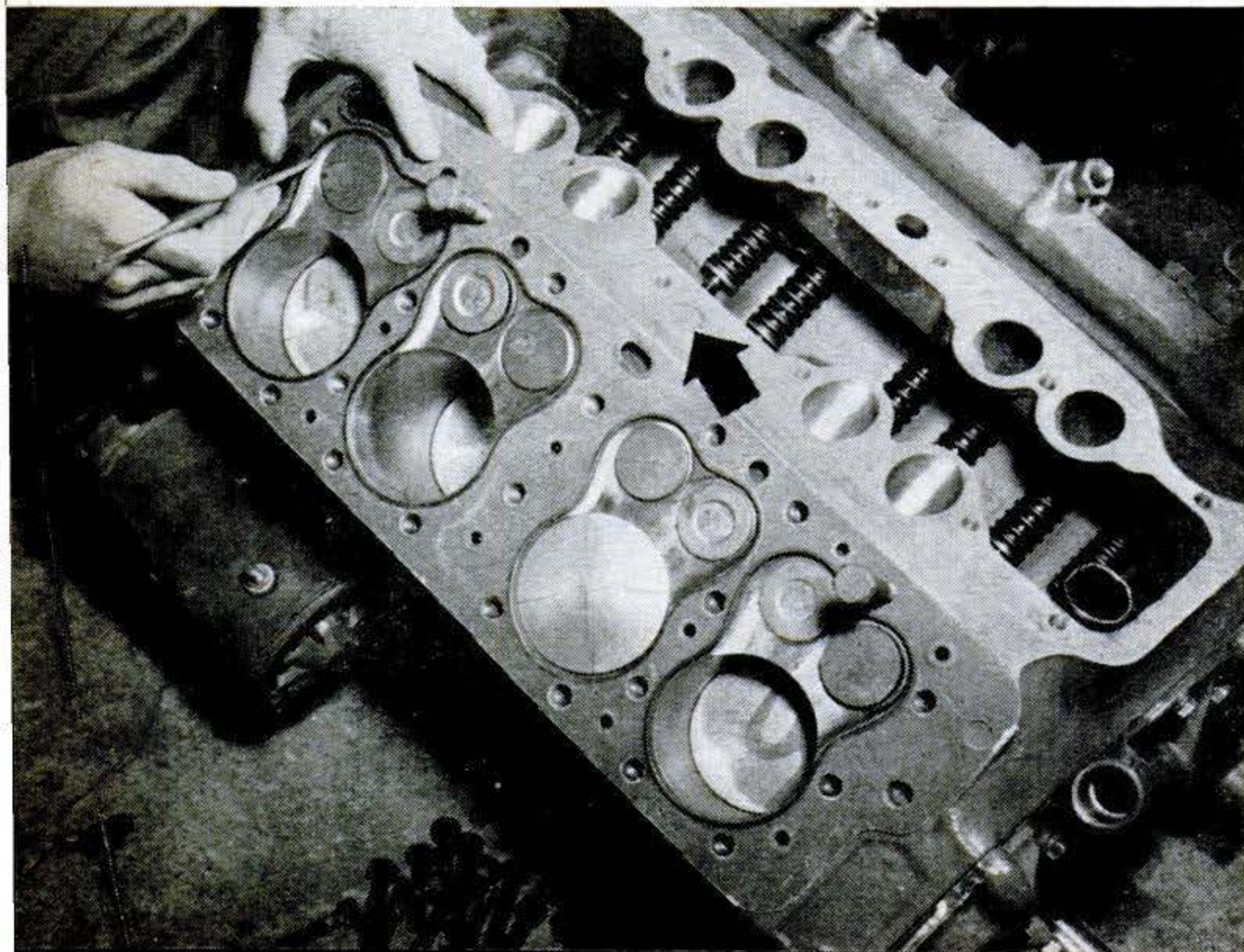

displacement. A new Mercury crank costs a little less than \$40.

The availability of this crank is why I never consider, for this job, stroking the stock Ford crank. (Stroking consists of grinding down the diameter of the crankpins, giving them new centers, to increase the piston travel.) About the best you could expect from stroking would be $\frac{1}{8}$ ". The Mercury crank gives you $\frac{1}{4}$ " without fuss or bother, it's stronger and costs no more.

With rebored cylinders you need new pistons. A set of the three-ring type (about \$3.10 each) fitted to .003" skirt clearance will make the engine free-working and give good oil mileage. Since the cylinder bores will be true, a steel section ring and inner ring will not be necessary; plain cast-iron rings will serve.

Porting and relieving. These are two more highly desirable steps. They will let the engine breathe a lot better, taking in a bigger charge of the power-giving mixture and expelling it more efficiently. The manufacturer doesn't spend extra time and money on these refinements, but they make a whale of a difference. Porting and relieving are jobs you can undertake yourself, or you can have them done for around \$36.

Next I'd turn my attention to the oil drain-back hole located in the front of the block under the cam gear. Its purpose is to feed oil from the relief valve to the timing gears. I would drill this hole $\frac{11}{32}$ ", tap it with a $\frac{1}{8}$ " pipe tap, drill a $\frac{1}{16}$ " hole lengthwise through a $\frac{1}{8}$ " pipe plug, and install the plug in the hole. The reason for this: If the

intake stroke, this permits more fuel to sweep into cylinder. On exhaust, it gives the gases a bigger path and helps reduce back pressure.

This photo shows a good way to keep your relieving within limits. Rest a gasket on the block and secure it with a couple of studs. Then scribe around inside of gasket openings between ports and cylinder.

Remove metal to a depth of about $\frac{5}{32}$ " at cylinder edge, sloping it back flush with valve ports. Grind sides to a gentle radius, avoiding sharp corners. Use a rotary file or small grinding wheel in an electric drill. After metal is removed, polish surface with a dentist's rubber abrasive wheel. Arrow indicates how copper pennies can be used to block heat-riser tubes.

HIGH-COMPRESSION HEADS are an easy way to get more power. The 21-stud head in foreground is for Fords from 1932 through 1938, others for later 24-stud Ford and Mercury blocks. Fins help dissipate heat.

DUAL INTAKE MANIFOLDS for V-8s are shown below. One in background is high-riser type. Mounting plate at right end takes fuel pump, oil stack and breather-cap assembly.

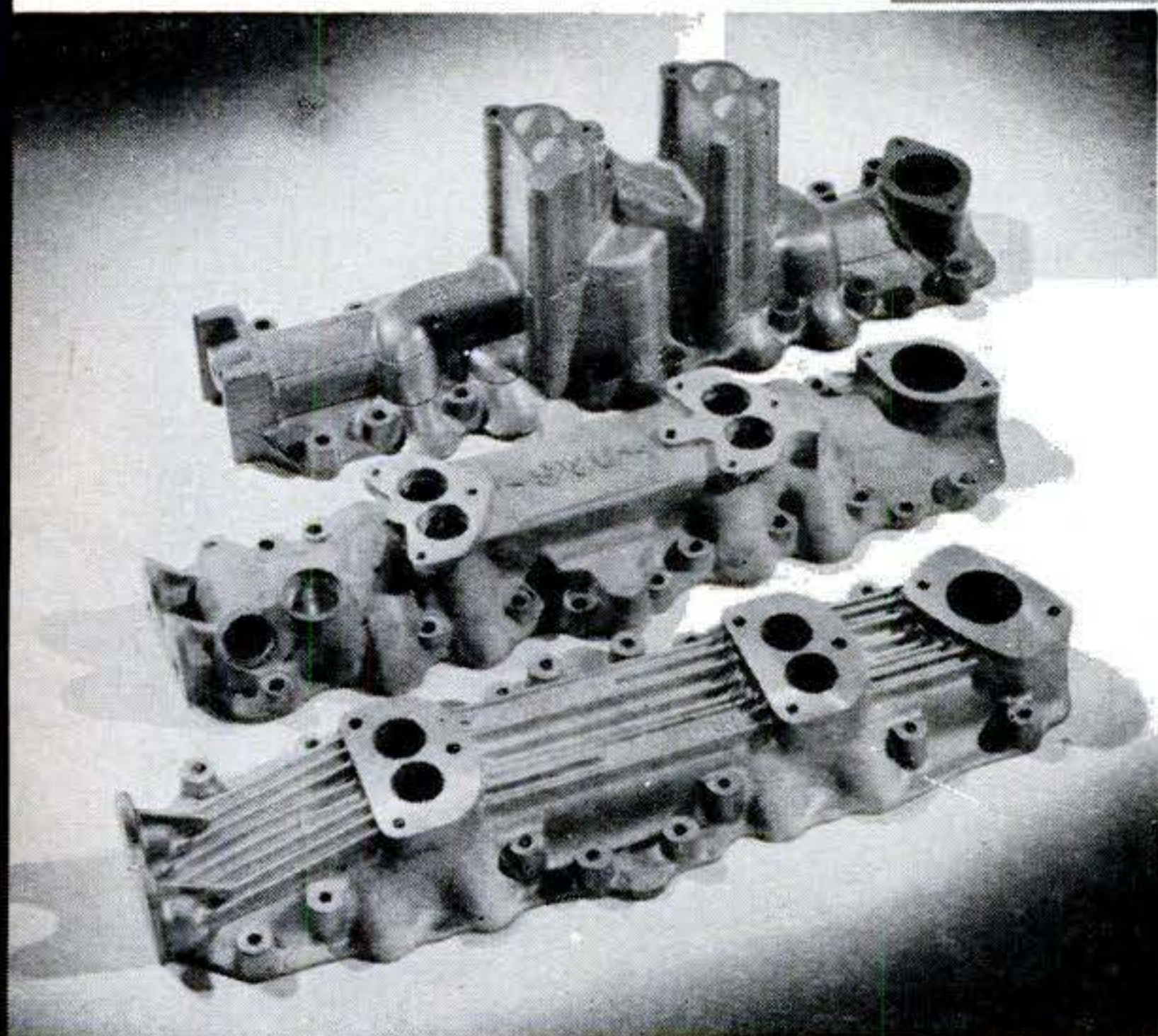
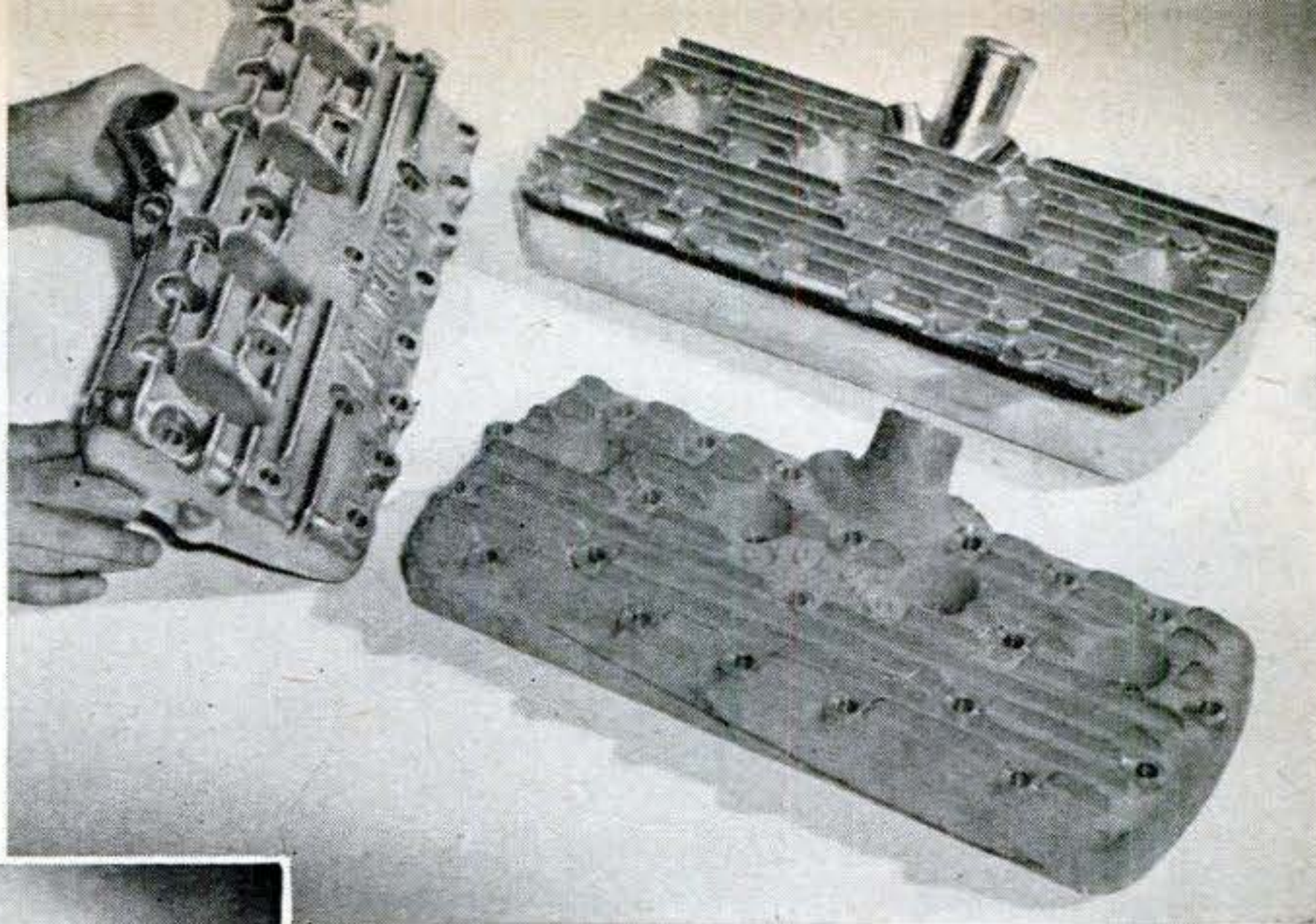

relief valve should ever stick open, there would still be some oil pressure.

Before leaving the block, I'd replace the camshaft bushings. This would help insure good oil pressure and valve operation.

Choosing a camshaft. For a road car that can also be used in a limited way for competition, I like a camshaft with a power grind—"jumping stick" in race-car slang. This stick is all acceleration. Power begins to develop around 1,200 r.p.m. and increases in a steady curve to about 5,800 r.p.m. Yet the engine will idle nicely and be smooth enough at low speeds to carry Aunt Tillie on shopping trips. This cam costs around \$35 with the old one in trade.

A full-race or super-race cam is designed to deliver peak horsepower only at speeds in excess of 80 or 90 m.p.h. Below that speed it serves no useful purpose.

Whatever the cam, I would be careful to set the valves at the exact clearance specified. For instance, if the instructions give .007" exhaust-valve clearance, I know that

.009" would disturb timing with consequent loss of performance. I'd grind in the valves to show a good matte surface all around the seat and use Lincoln Zephyr valve springs (30 cents each). These will keep the cam followers from bouncing at high r.p.m.

High-compression heads. Aluminum hi-comp heads usually are far more satisfactory than milling off a stock cast-iron head to decrease the combustion space. With the latter, overheating becomes a problem at high speeds. Pistons and valves come too close to the top of the head, and chances are the head would have to be relieved over the pistons and valves.

Many good aluminum heads are on the market. A typical cost is about \$75 a pair. A lot of people don't know that the Ford Motor Co. itself puts out hi-comp heads. These, I think, are every bit as good as the ones put out by the specialty shops—and the cost is less, around \$40.

Unless I planned to race with alcohol-blended fuels, a compression ratio of 8.5:1 is about as high as I would want to go with ordinary high-test gasoline. Anything higher would necessitate retarding the spark and sacrificing performance.

To help engine breathing, you need an intake manifold that's free of obstructions and sharp bends. I would install one of the dual-carburetor manifolds that are made especially for the Ford V-8. But before installing the manifold, I'd block off the heat-riser tubes in the cylinder block with copper pennies. Heat in the manifold cuts down volumetric efficiency. Manifold and extra carb run around \$50.

Dual exhausts. These are a definite help. The existing Ford exhaust system is designed for normal r.p.m. and a single carburetor. When cam timing is changed, dual

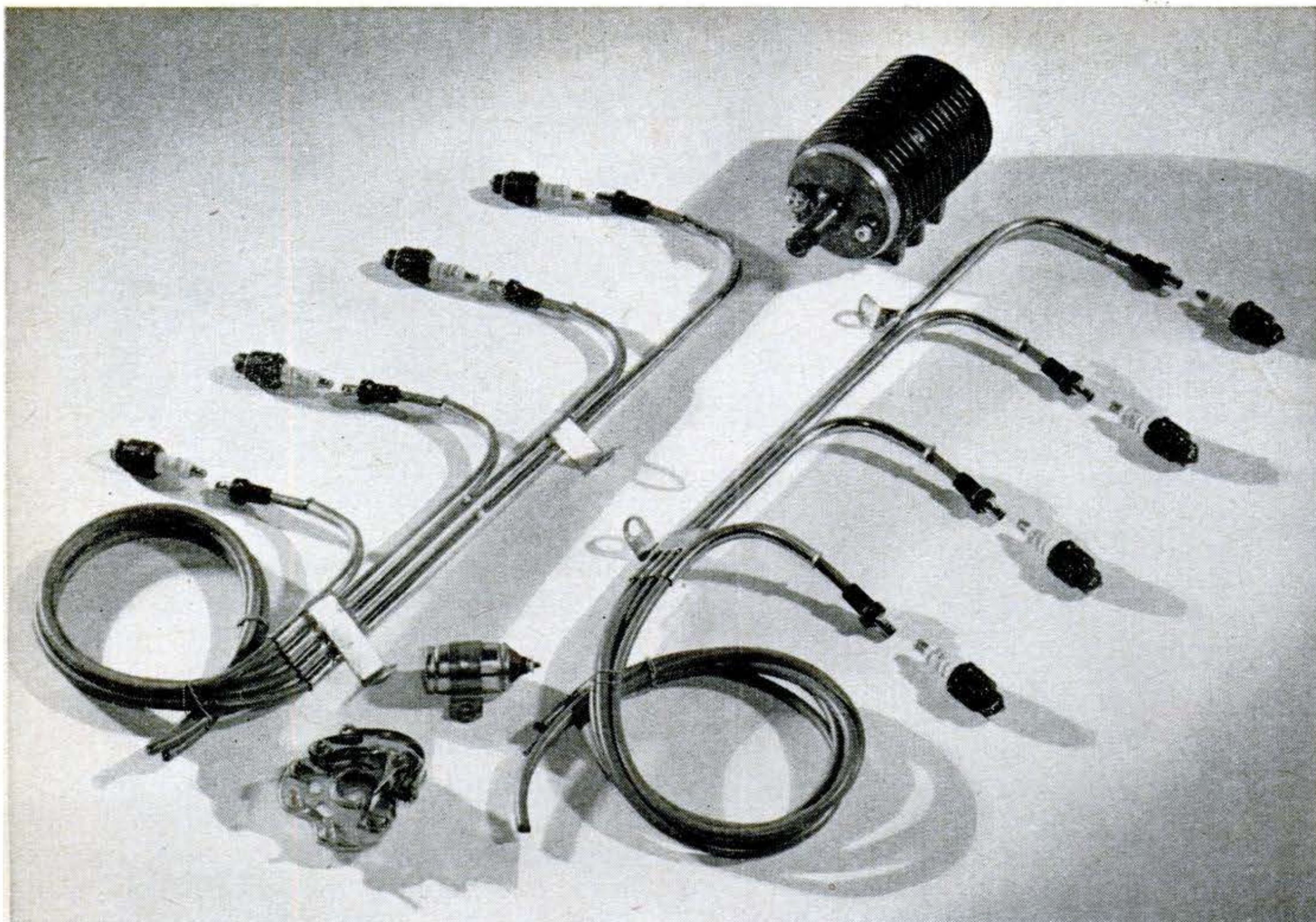

HOT SPARKS FOR HIGH SPEEDS come from ignition outfits like this. Racing coil at top right is air-cooled. At lower left is a dual-

point conversion unit, plus condenser. On either side are chrome ignition-wire holders. Cooler plugs are usually needed.

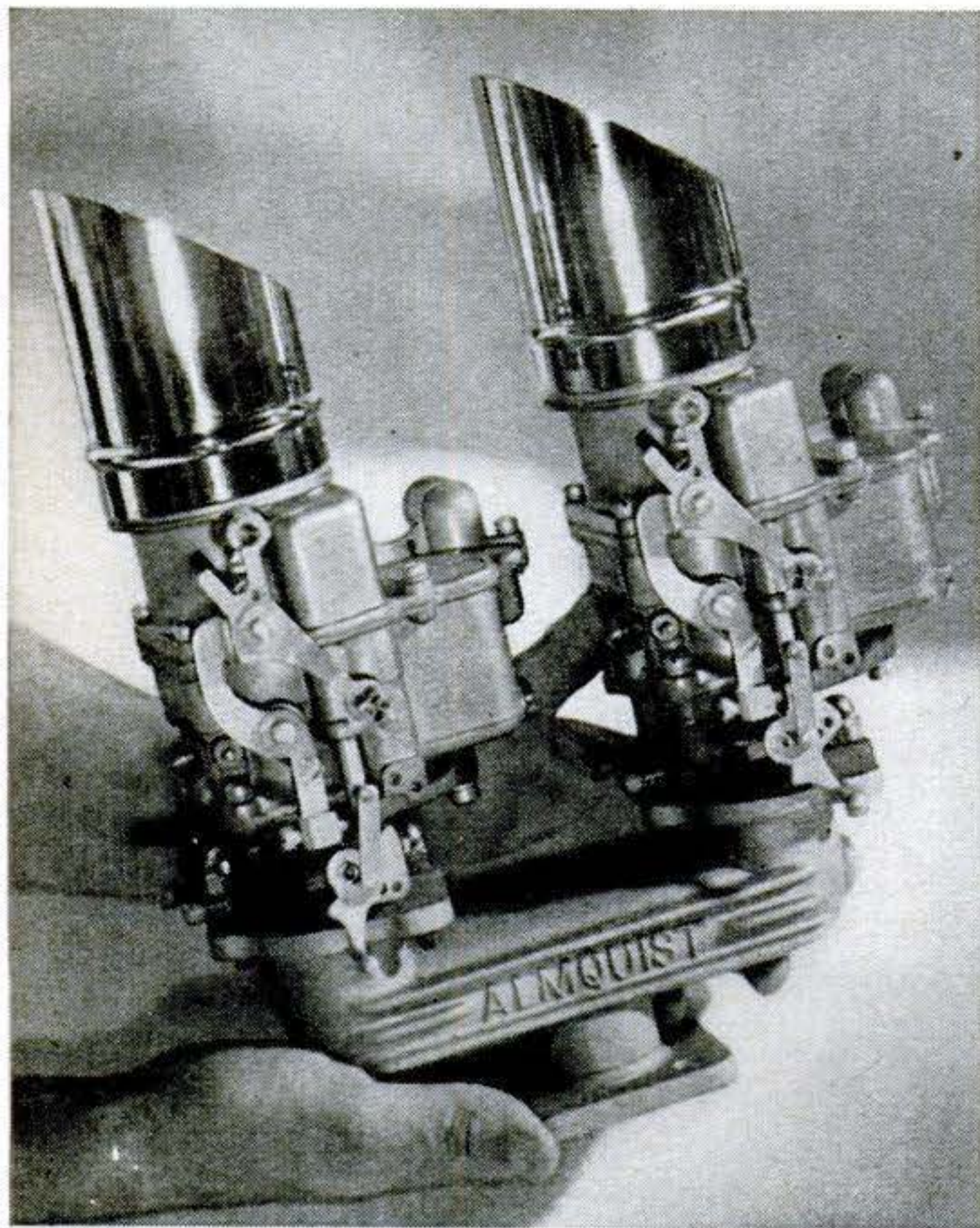

TWIN CARBURETORS can be mounted on stock manifold with adapter like this. Such a setup is claimed to keep each carburetor operating in its maximum economy and efficiency range. Velocity stacks often replace air cleaners on souped engines, especially race jobs.

carbs are installed and compression is raised, a single pipe does not permit good scavenging of the exhaust gases. Back pressure occurs. Exhaust gas left in the cylinder weakens the new charge and causes overheating, resulting in either detonation or pre-ignition. Several good dual-exhaust systems are on the market, or I might make up my own, using stock Ford parts. Some people like the deep tone of the open Hollywood-type muffler, but John Law may not.

The standard Ford ignition system, with double springs behind the contact points, will work out very well up to 5,000 or 6,000 r.p.m.—and that's about all you ever would want on this particular job.

To use the new power and speed, the chassis must be suitable. Brakes are very important naturally. Hydraulic systems for Fords as early as 1932 models are available, and they are not hard to mount. Springs get "tired" from age and lose their elasticity. Good springs, and shock absorbers to control their action, are an absolute necessity.

And above all, I'd be sure the steering parts and front end were free of play and stiffness. Going into a high-speed turn, I'd then feel a lot better. END

Where's the Car Key?

THAT BIT OF BRASS is vital but often elusive. To avoid being hung up by a lost key, many autoists hide a spare one outside. The spots shown at right are favorite ones, but there are lots of others. Wire or tape it securely.

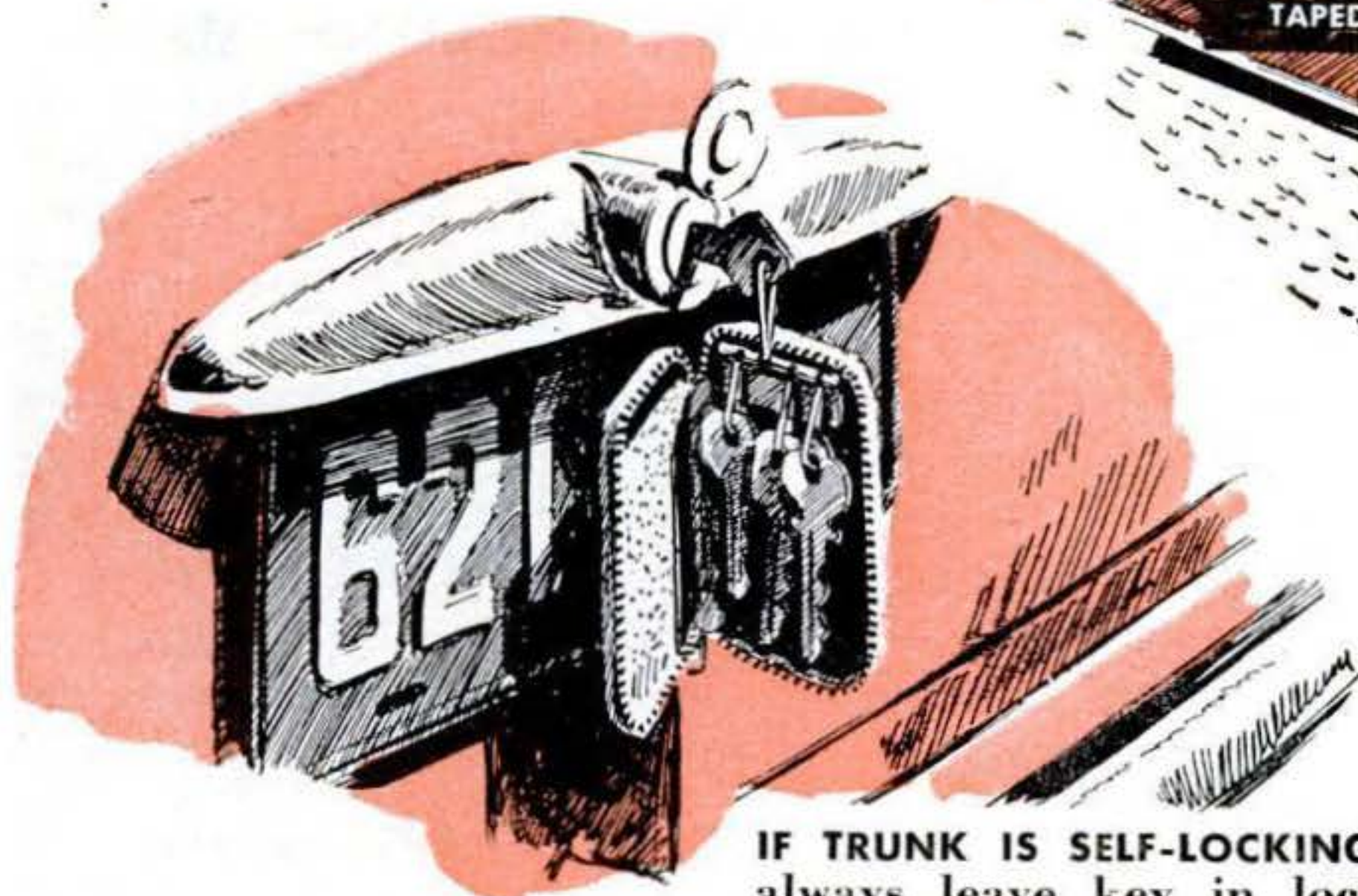
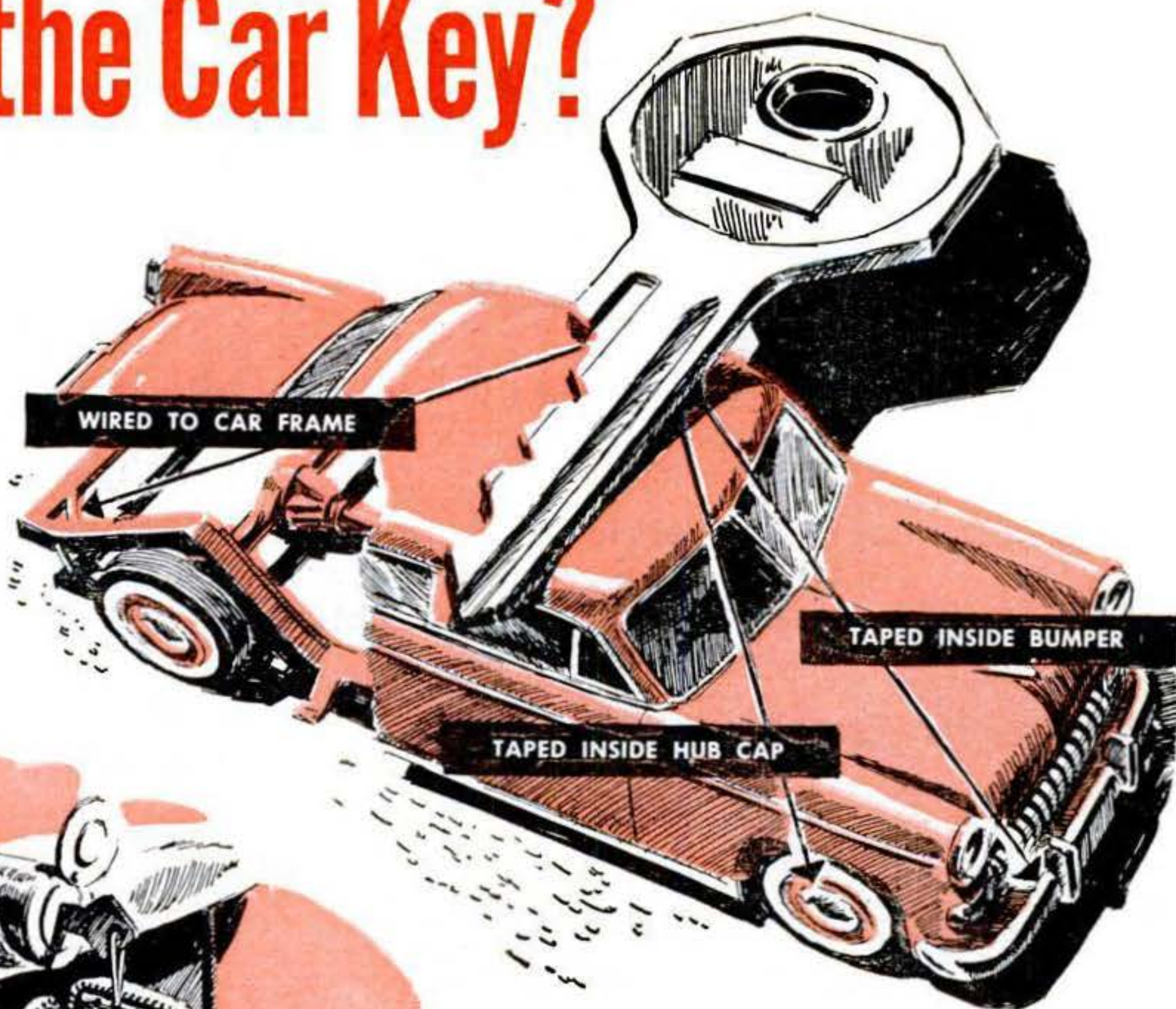

IF TRUNK IS SELF-LOCKING, always leave key in lock while lid is up. If you don't, you may accidentally slam lid with keys inside.

NOTE THE NUMBER of each car key on a slip of paper and keep it in your wallet or other safe spot. You can then get a replacement faster.

NEVER LEAVE KEYS in the ignition while car is parked on the street. Besides inviting theft, this is a violation of local law in many communities.



MAKE IT A HABIT to feel for your keys before locking the doors if your car is the kind that can be locked without key. Otherwise you may lock key inside.

CHECK TROUSER CUFFS when your key is lost. Missing keys are frequently discovered there.



A DROP OF SOLDER to close each snap hook in a key holder will keep keys from slipping off. Otherwise, single keys can be lost even if holder isn't.

Gus and the Car That Wouldn't Turn Left

Doc Evants diagnosed Gabriella's temperamental behavior as some sort of warning—but Gus figured all she needed was a little discipline with the business end of a monkey wrench.

By Martin Bunn

ON A cold, brisk Sunday a few weeks ago, Gus Wilson was enjoying an afternoon off from his chores at the Model Garage by strolling through town. Suddenly a chorus of honking horns directed his attention toward the intersection ahead.

"Must be an accident," thought Gus as he hurried toward the commotion.

As he got closer, he saw that two sedans had locked bumpers diagonally across the intersection and were blocking traffic in four directions. A stocky redhead was standing beside the first car shaking his fist at the driver.

"You lunkhead!" he shouted. "What was the idea of stopping so short? For two cents I'd—"

Just then Officer Pat Stanton strolled up. "Okay, you two. Break it up." He waved the redhead back to his own car. "Get these cars outa here or I'll give you both tickets."

As Gus reached the curb, the door of the first car popped open and out stepped a wiry, bespectacled little old man. In spite of the freezing weather, he wore neither overcoat nor hat. His odd costume consisted of well worn sneakers, a pair of baggy gray pants, a large corduroy jacket, and a plaid wool scarf looped twice around his neck with the ends dangling fore and aft.

Gus Spots an Old Friend

Gus looked at the little man, then at the man's car, and did a double take. It was none other than "Doctor" Jason Evants, the town's best known eccentric and founder of the "Philosophy of Universal Sentiency"—a fad that interested some of the wealthier ladies in the community.

Gus had first run into Doc Evants when the buxom and affluent Mrs. Miller—who had been widowed a year or so ago and had since joined the little "doctor's" group of followers—sent Evants to the Model Garage with Gabriella. Gabriella was his car. Not only did the car bear a name, it could also think and feel—strictly in accordance with the rule of the Philosophy of Universal Sentiency which said that all inanimate things could. At least, that was Doc's story. He insisted "she" had frequently warned him of impending danger by suddenly stopping or refusing to run at all.

Doc Evants Heeds a Warning

"Doctor Evants," called Gus as he walked over to the man. "Having trouble?"

"Ah, Mr. Wilson. Trouble you say." Evants waggled a finger at the redhead. "As you undoubtedly ascertain, this unpleasant individual collided with my car and has interlocked our bumpers."

"Maybe I can help," said Gus. Then he walked over to the second car and climbed up on the front bumper. "Okay," he called, motioning to the redhead. "Put your car in reverse and ease her back slowly."

On the fifth jump, Gus's weight finally jounced the bumper loose and the two cars gratefully parted company. Officer Stanton waved the redhead on his way and Doc Evants climbed back into his car. But instead of turning the corner he straightened out, drove into the through street ahead and parked.

Gus was curious enough to follow.

"Sorry to have been so curt, Mr. Wilson," said Doc Evants, "but I'm afraid that uncouth mental midget unnerved me a bit. Obviously the ebullient type suffering from



"Doctor" Evants graciously opened the door to his car. "Let me give you a lift to your garage and I'll tell you about it."



"She's beginning to. It was a warning from her that helped cause that slight difficulty at the corner."

"Huh?"

Dr. Evants graciously opened the door to his car. "Let me give you a lift to your garage and I'll tell you about it."

Gus was about to say something about it being his day off, but his curiosity got the better of him and he climbed in with the little old fellow.

Dr. Evants started the car, going through the motions deliberately and slowly. "You see, Mr. Wilson, I was on my way over to see Mrs. Miller about a most important matter. As I was making that left turn from Bank into Main Street, Gabriella II began to sputter and buck as if she were reluctant to go in the direction of Mrs. Miller's house. As if she were trying to warn me."

No Left Turns Allowed

The little man seemed very upset. At that point, he started to make a sharp left turn into Center Street. Sure enough, about halfway through the turn the engine began to miss and falter. The car had enough momentum to make the turn, but Dr. Evants would have none of it. He quickly straightened the car out and continued on ahead. When he did, Gabriella II's engine picked up and ran smoothly again.

"You see, she protested against making that turn."

Gus nodded, but said nothing.

At the next few corners, when Dr. Evants tried to make similar left turns, the same thing happened, and each time he wouldn't complete the turn. As a result, the trip to the garage turned out to be a circuitous tour of the town consisting of right turns only.

By the time they finally made the last right turn into the road that led past the garage, Gus had several ideas about Gabriella's hesitancy.

Stan Hicks, the helper at the Model Garage, was busy chipping away ice on the drive when Gus and the doc pulled up. "Hi. What are you doing here?"

"Meet Gabriella II," said Gus with appropriate flourish. "And she has a few of Gabriella I's—shall we say—peculiarities," he added, winking at Stan. "Doctor, why don't you let me check her to see whether she really is trying to warn you not to see Mrs. Miller today or whether it's something else?"

[Continued on page 226]

introversions that can be salvaged only by expressions of superiority."

"In other words," said Gus with a smile, "a sorehead."

"It could be expressed that way."

Gus Meets Gabriella II

"But what happened to Gabriella?" asked Gus, looking at the car parked at the curb. It was a '41 model in fair shape, while Gabriella, as Gus remembered her, had been a beat-up '35 sedan.

"Ah, Gabriella," sighed Doc Evants. "I finally had to retire her. Old age. She's spending her days out in the yard behind my house. I go out and sit in her every so often. We still understand each other perfectly."

Gus started to point to the car at the curb.

"This, Mr. Wilson, is Gabriella the Second. Thanks to dear Mrs. Miller and a few other friends of my Philosophy of Universal Sentiency I was able to invest in this more modern vehicle a short while ago."

"Does this one warn you the way your first Gabriella did?" asked Gus, suppressing a smile.



Hints from the Model Garage

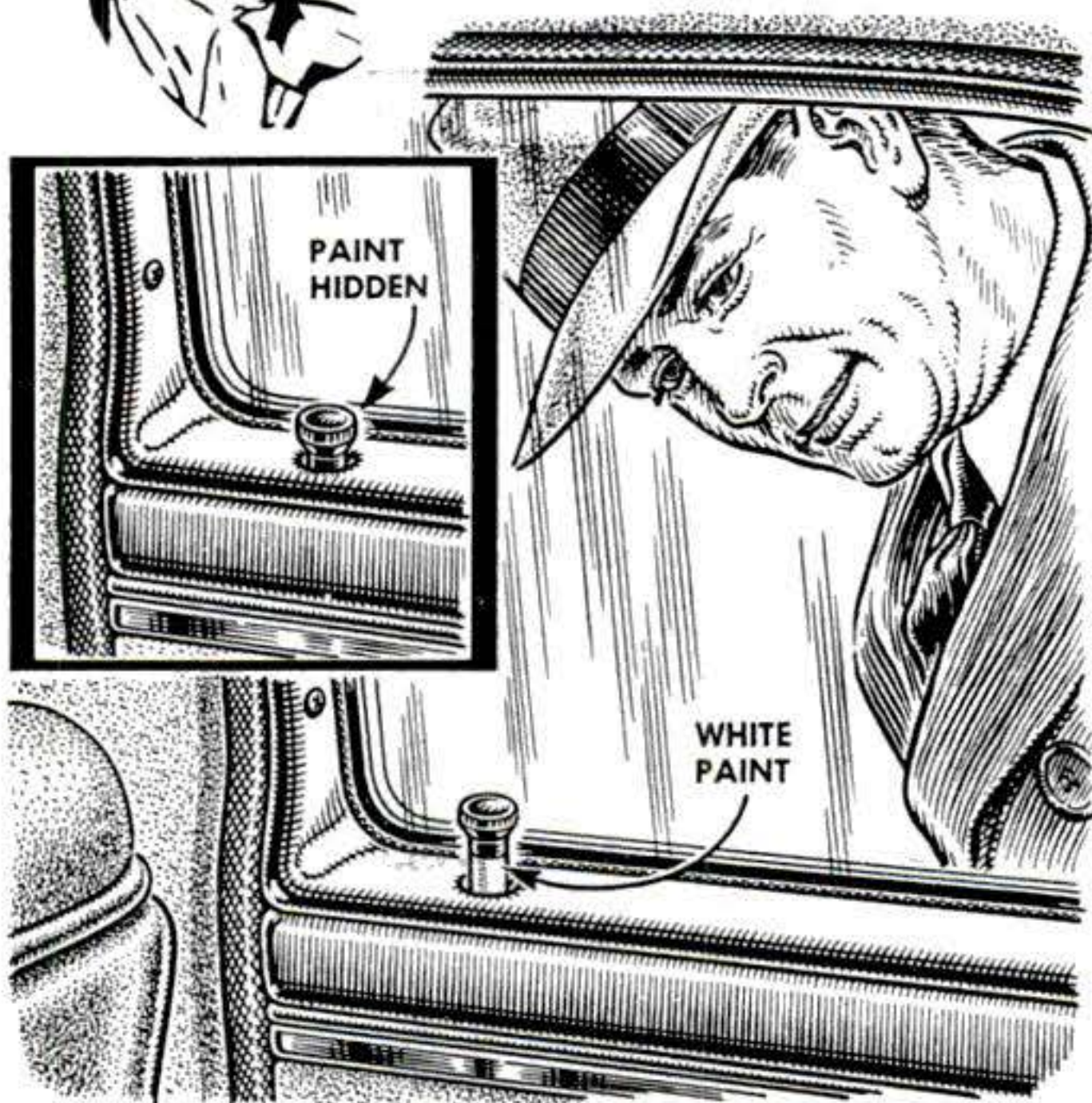

Paint Shows Button Position. From a distance it is sometimes difficult to tell whether car-door lock buttons are up or down. To remedy this, pull them up and paint a white strip around the base. If strip doesn't show, the door is locked.

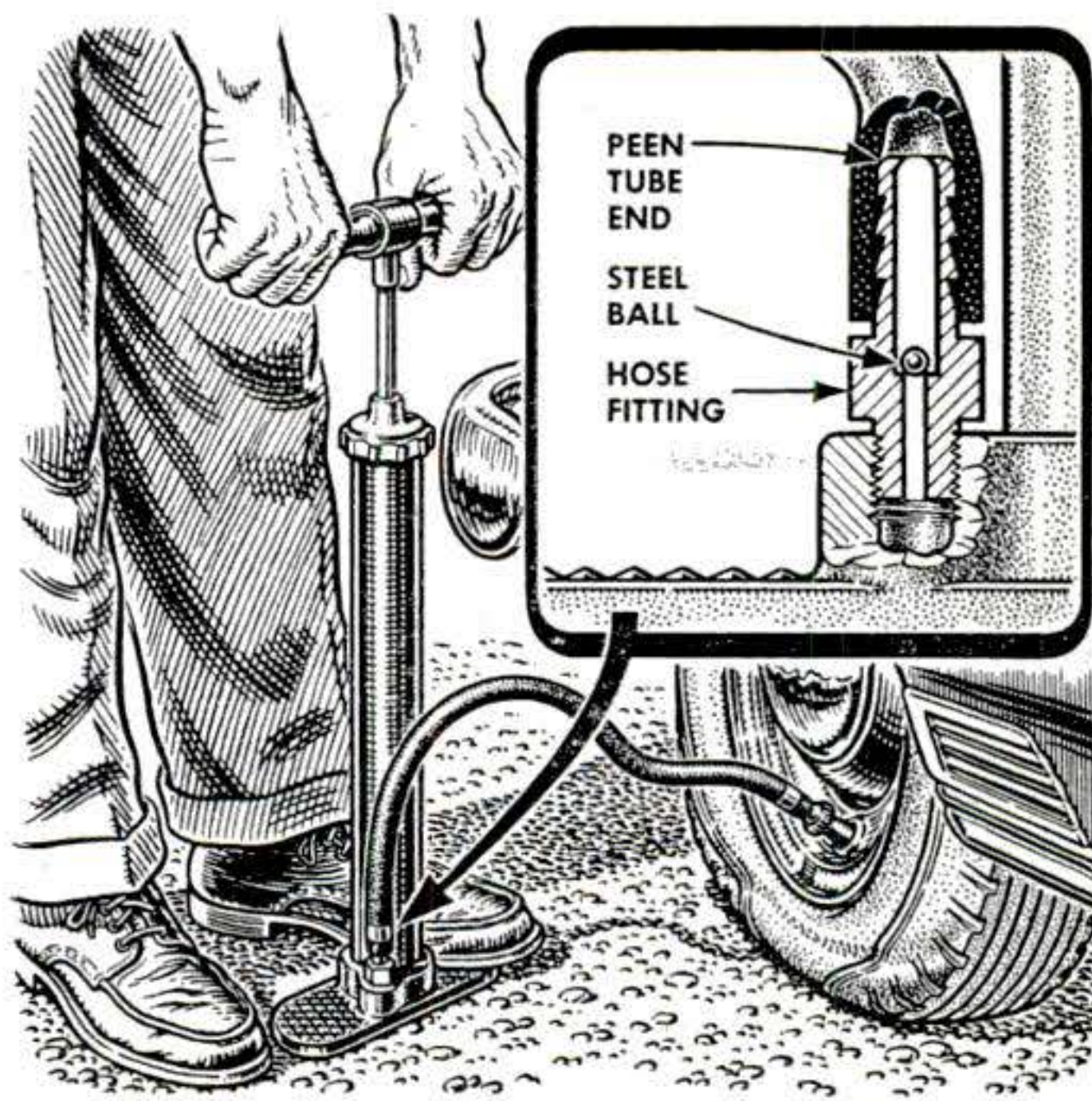

Ball Check Speeds Tire Pumping. An ordinary tire pump may be hard to use if air leaks back from the tire. David R. Fay of Buffalo overcame this by installing a ball check. The ball used was obtained from an old bicycle-wheel bearing.

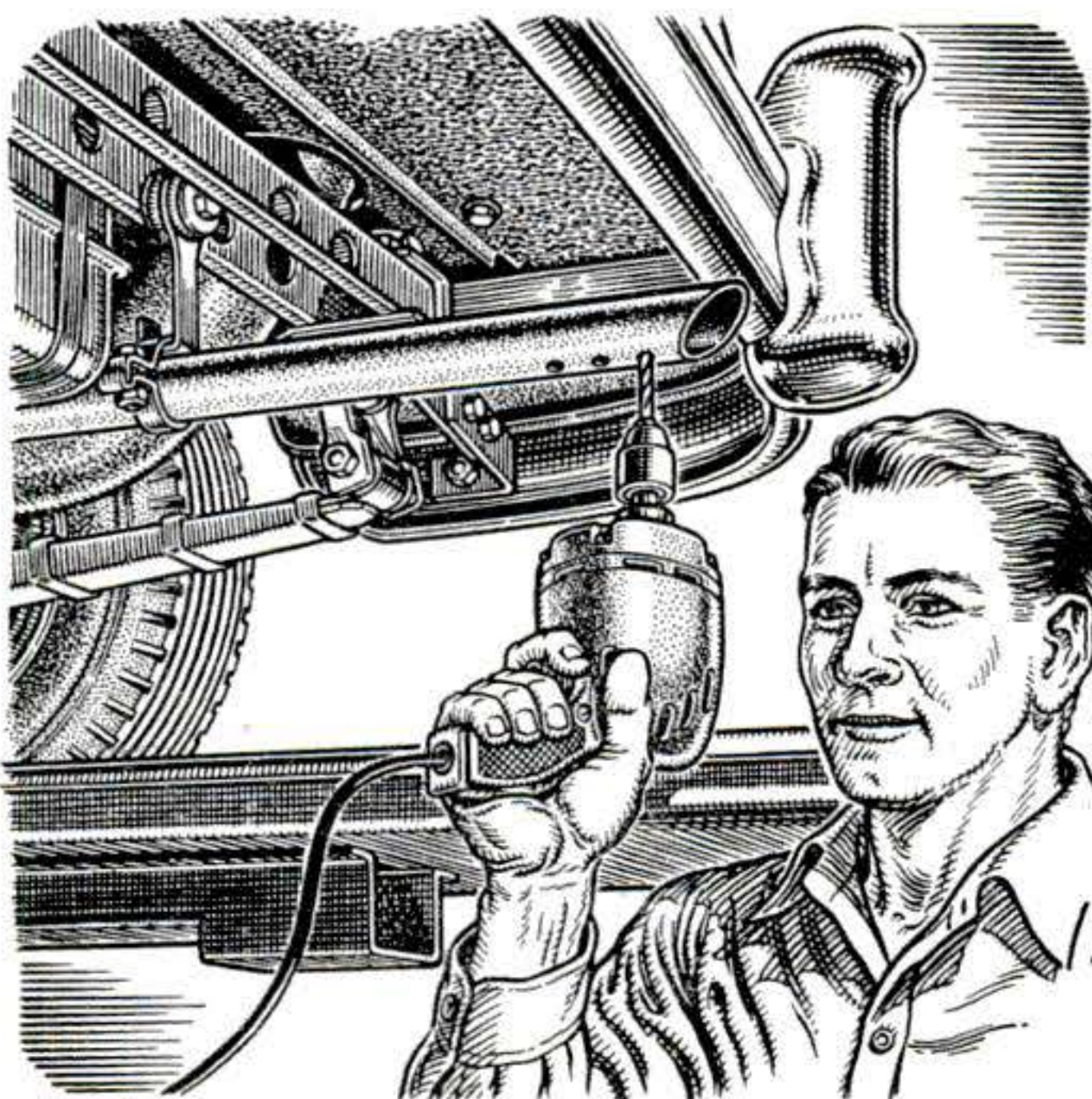

Drilled Holes Drain Tailpipe. You can retard corrosion of a tailpipe by drilling three 3/16" holes 1" apart at the exhaust end, as shown here. The holes will give condensed water a better chance to drain out of the pipe.

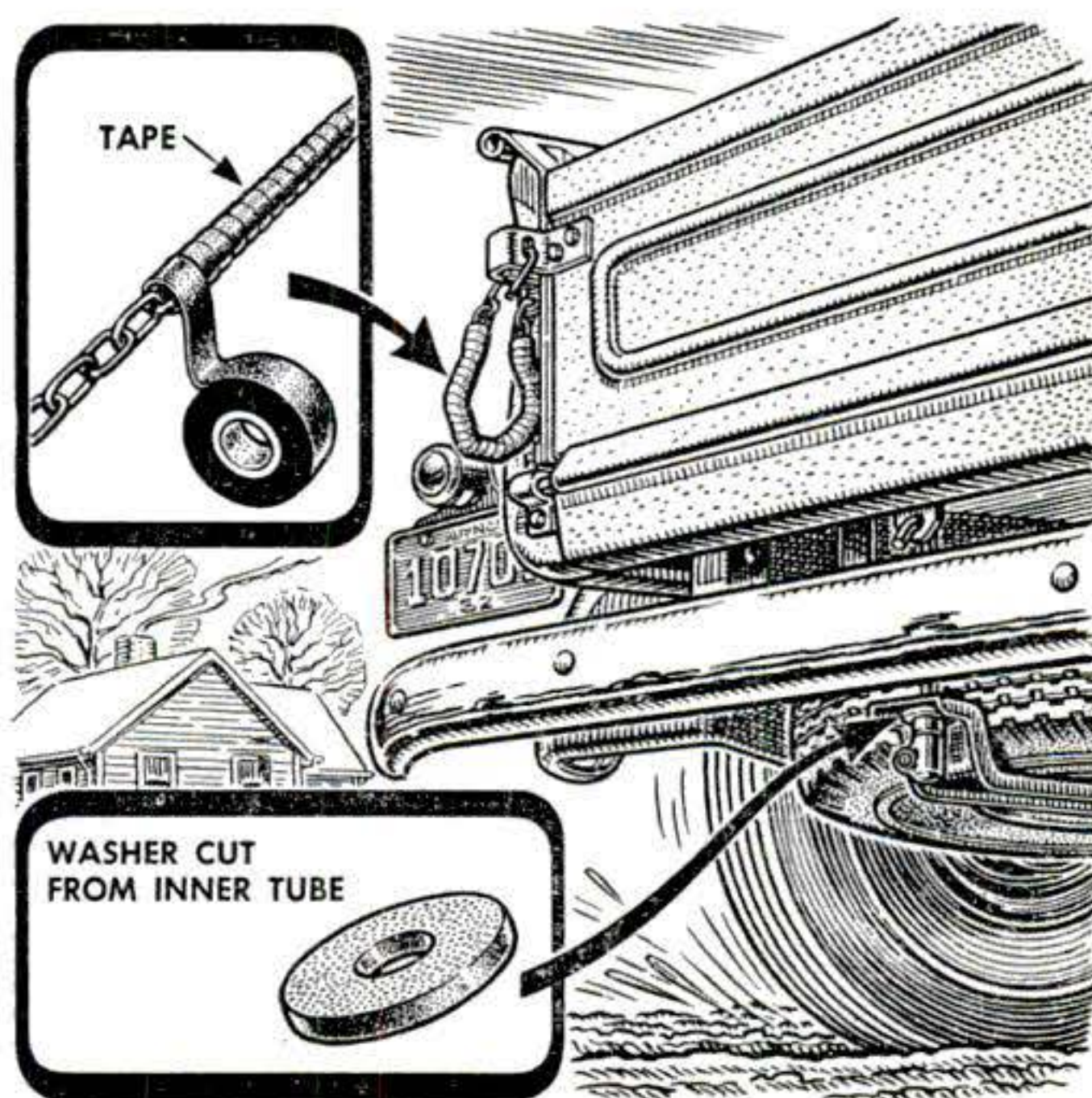

Curbing Truck Noises. Tail-gate chains on a trailer or light truck can be silenced by winding them with tape. If a spare-tire lock like the one shown rattles because of play between the lock and receptacle, insert a rubber washer to take up slack.

Please turn the page for four more auto hints.

JANUARY 1952 | 81



Painting Dash Bulbs Cuts Glare. You may like to try an idea that comes from Jim Larson of Dayton, Iowa. He pulled out all light bulbs on the dash of his '47 Chevy, dipped them in green paint, dried them under a heat lamp and put them back. This cuts glare when they are on full and produces a new-model lighting effect.

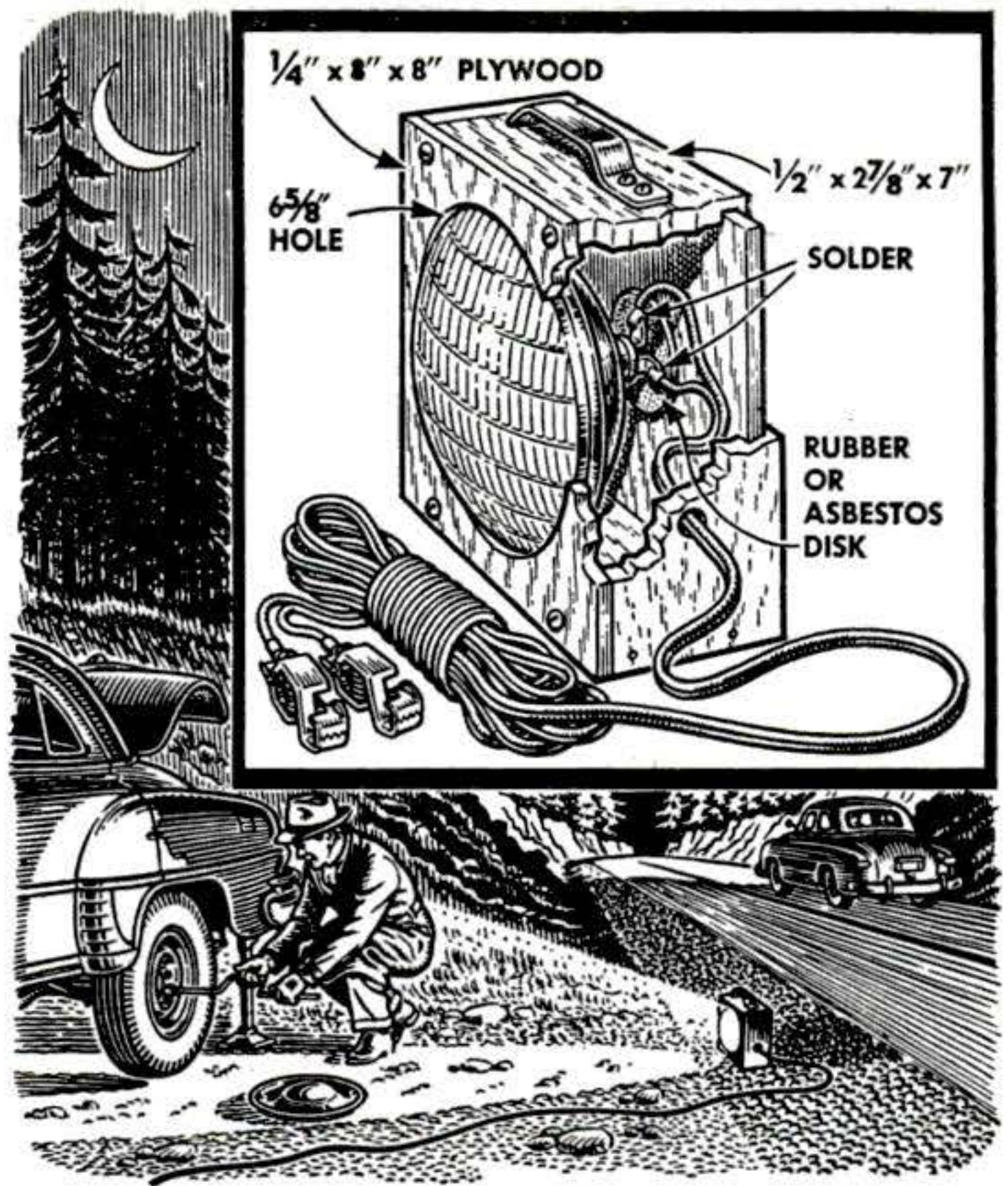

Lamp for Roadside Emergencies. When one beam of a sealed-reflector headlamp goes kaput, pack the unit into a box and carry it for night tire-changing and such. Test the three prongs on the back of the lamp to find which two give light. Solder a 15' lead to these. Clamp lamp between box front and the rubber disk.

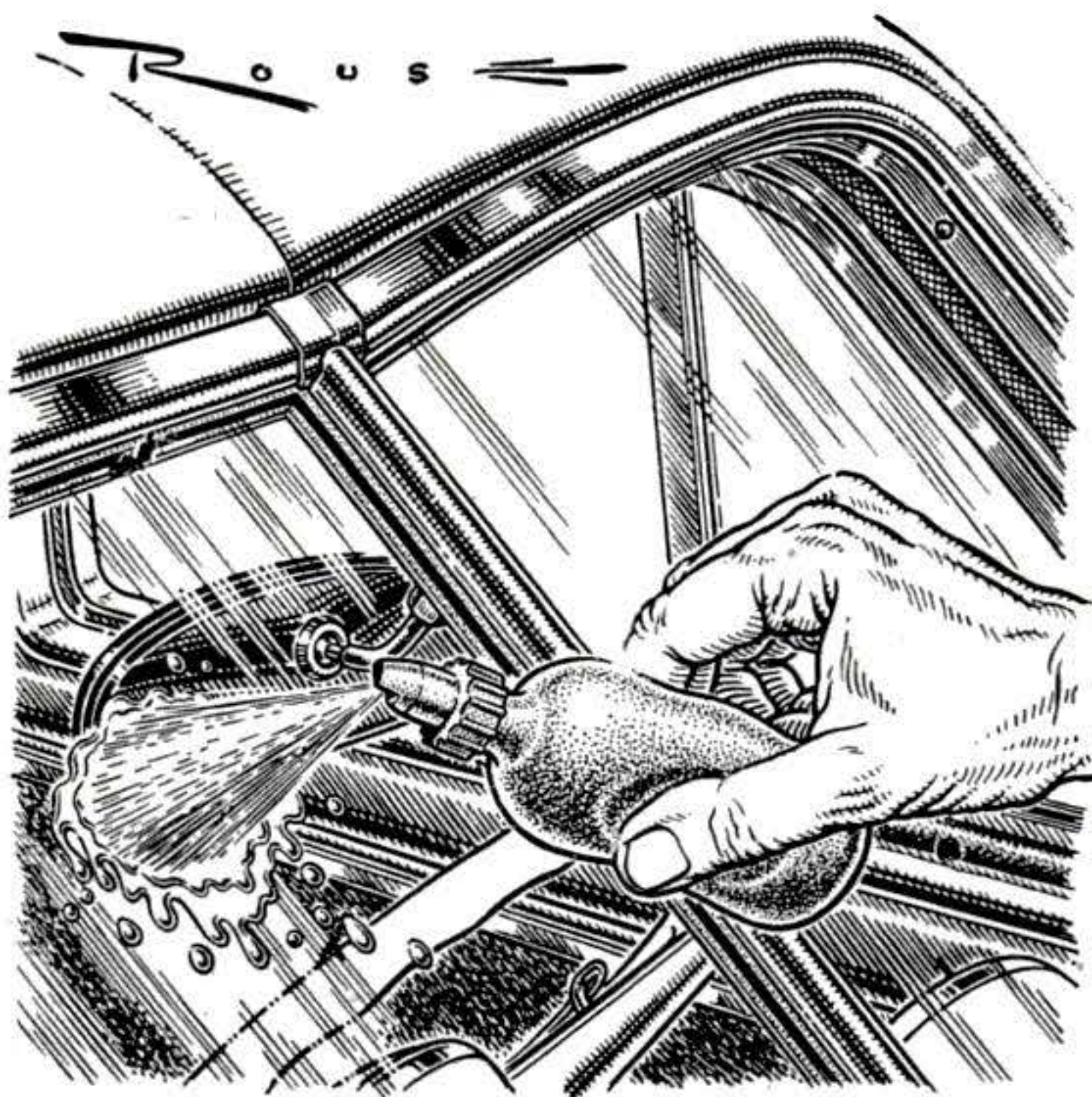

Plastic Bottle Cleans Windows. Refilled with window-cleaning fluid, a flexible-plastic bottle is a handy item to carry in the glove compartment. Empty bottles of this type can sometimes be bought in a drug or dime store.

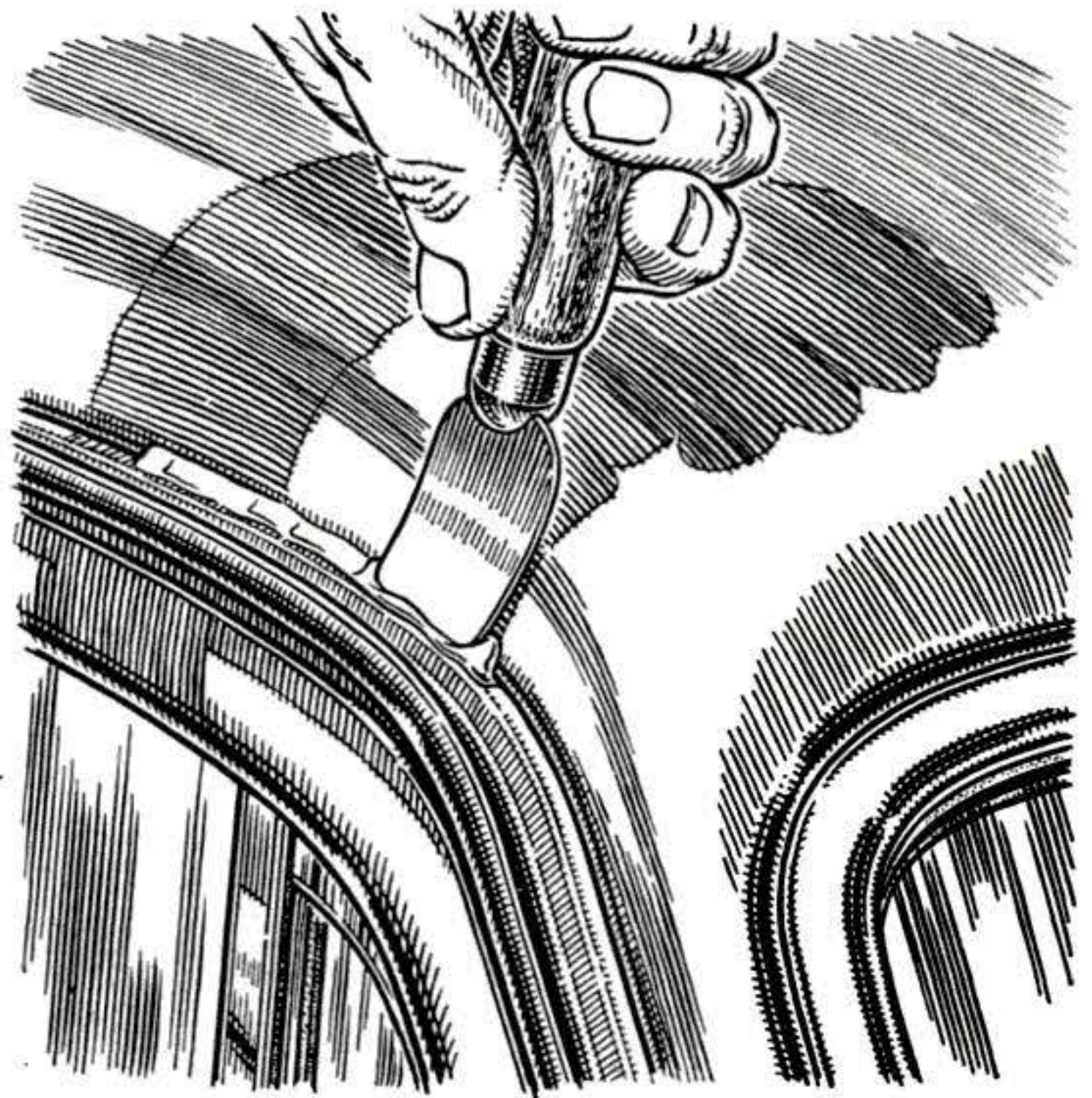

Calking Protects Eave Trough. If the original calking falls out of the eave-trough joint on your car, replace it with knife-grade compound and paint the compound a matching color. Water will collect in seams left open, causing rust.

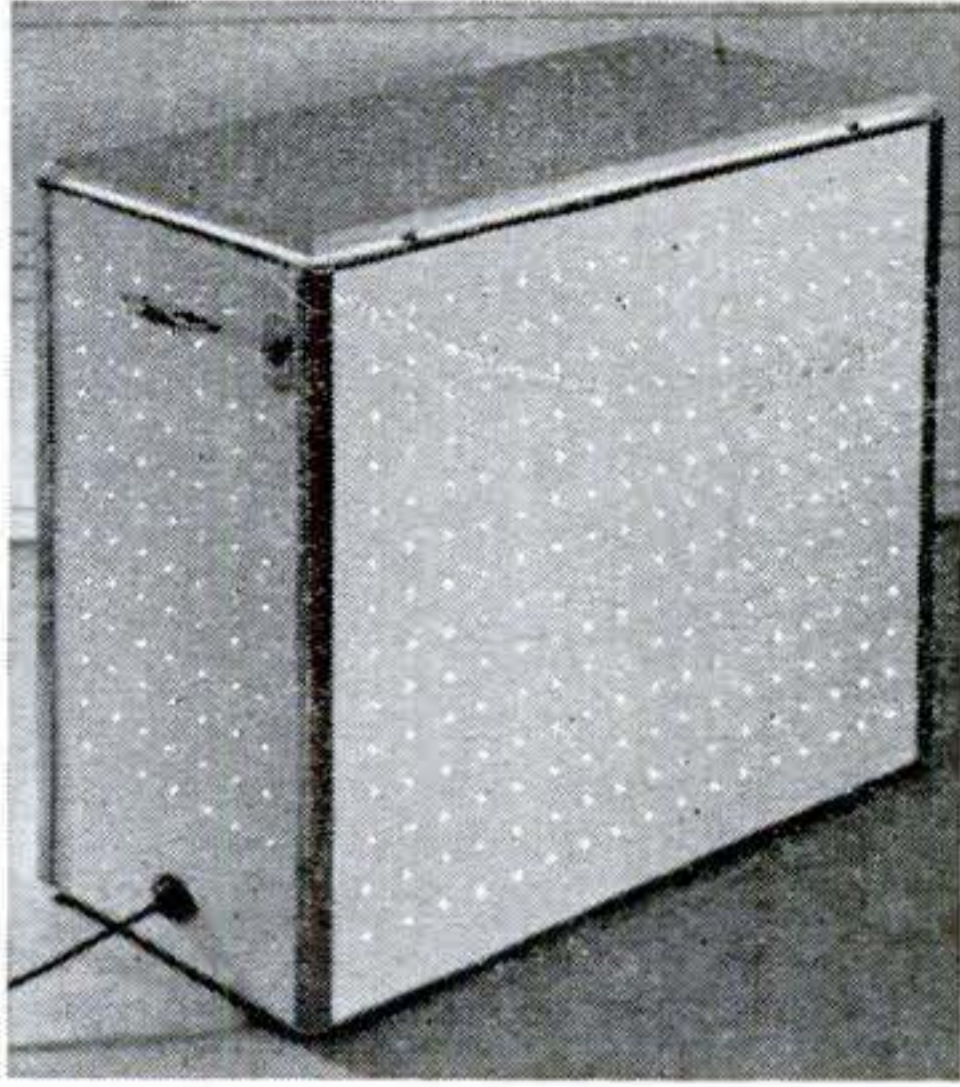

Hamper Dries the Clothes, Too

Four 100-watt bulbs circulate heat through this drier-hamper, which turns out a batch of dry wash in an hour.

By Carlton Strickland

IT LOOKS like a hamper, holds clothes like a hamper, sits in the bathroom like a hamper, and it is a hamper—but more, too. On those rainy Mondays when other house-

wives cry about their wet-wash, your wife can finish hers right on schedule. Just roll this box out, plug it in—and it's an electric drier. It was designed to help my wife keep up with baby's demands for "a dry one," but she soon found that it does a swell job on most of the regular wash.

Start with the frame. I found the easiest way to build the frame was to assemble the front and back first and then add

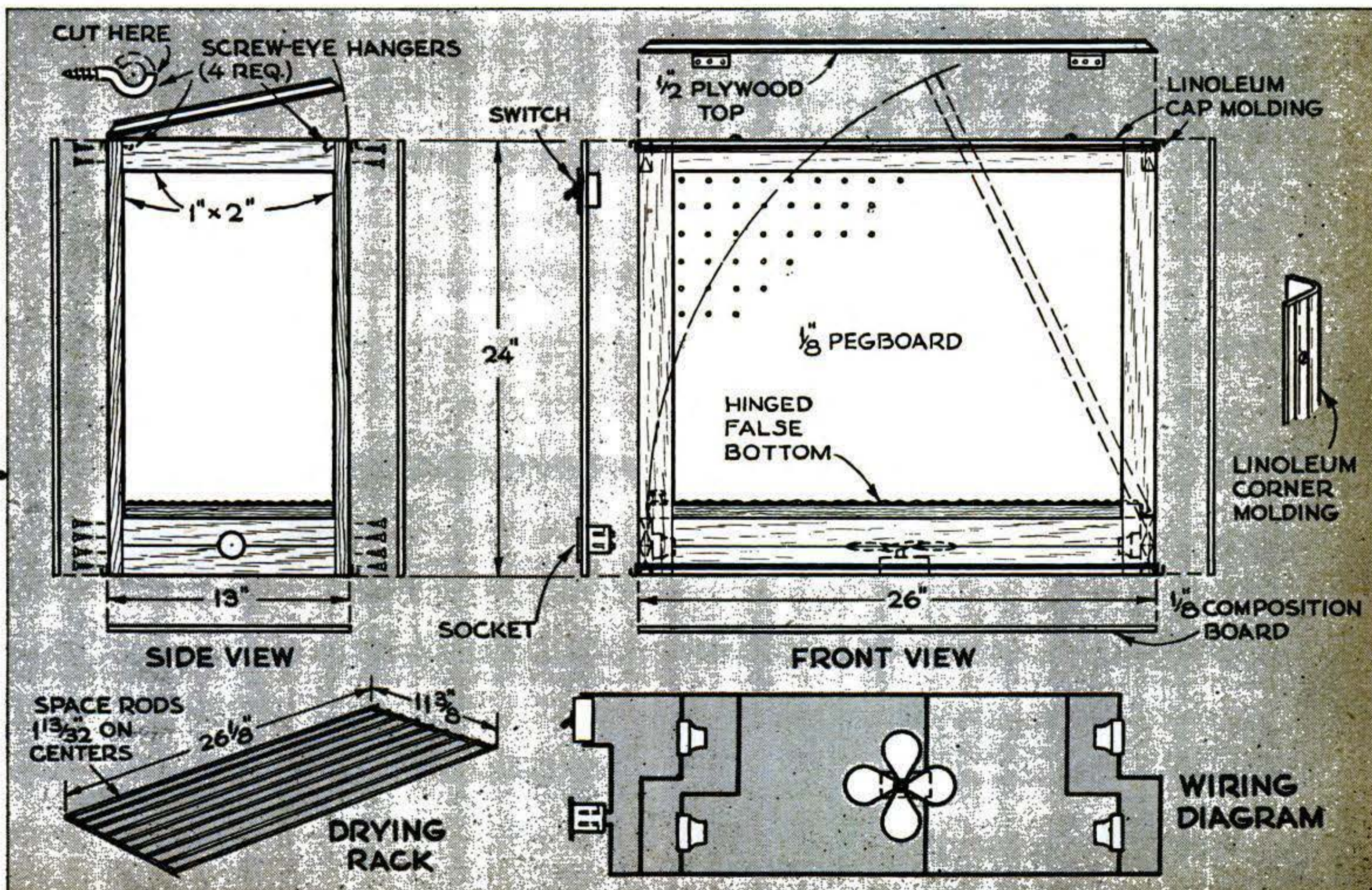

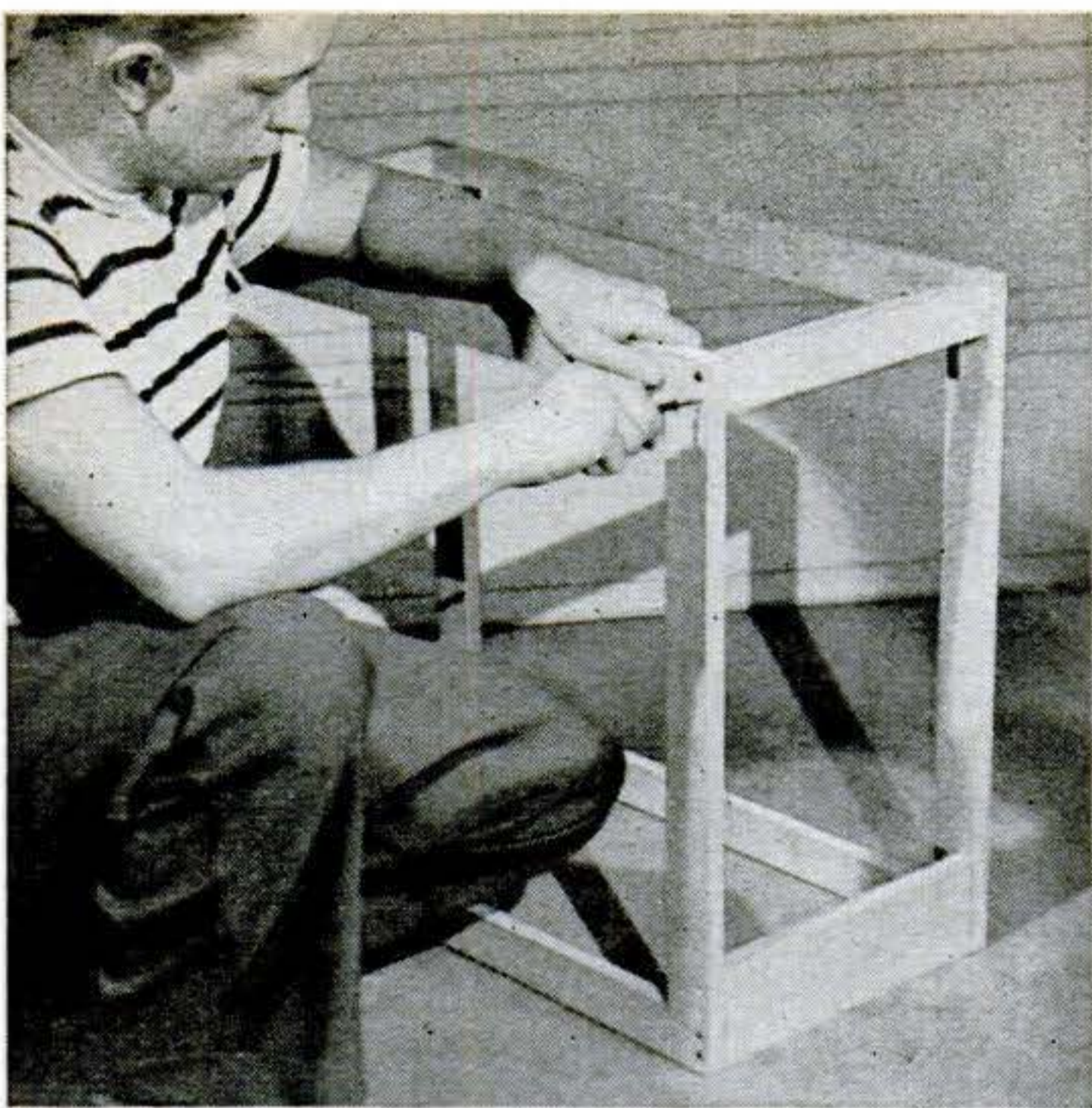

FRAME is made of 1" by 2" pine strips. Here front is being joined to back with crosspieces. Lower crosspieces are double strips.

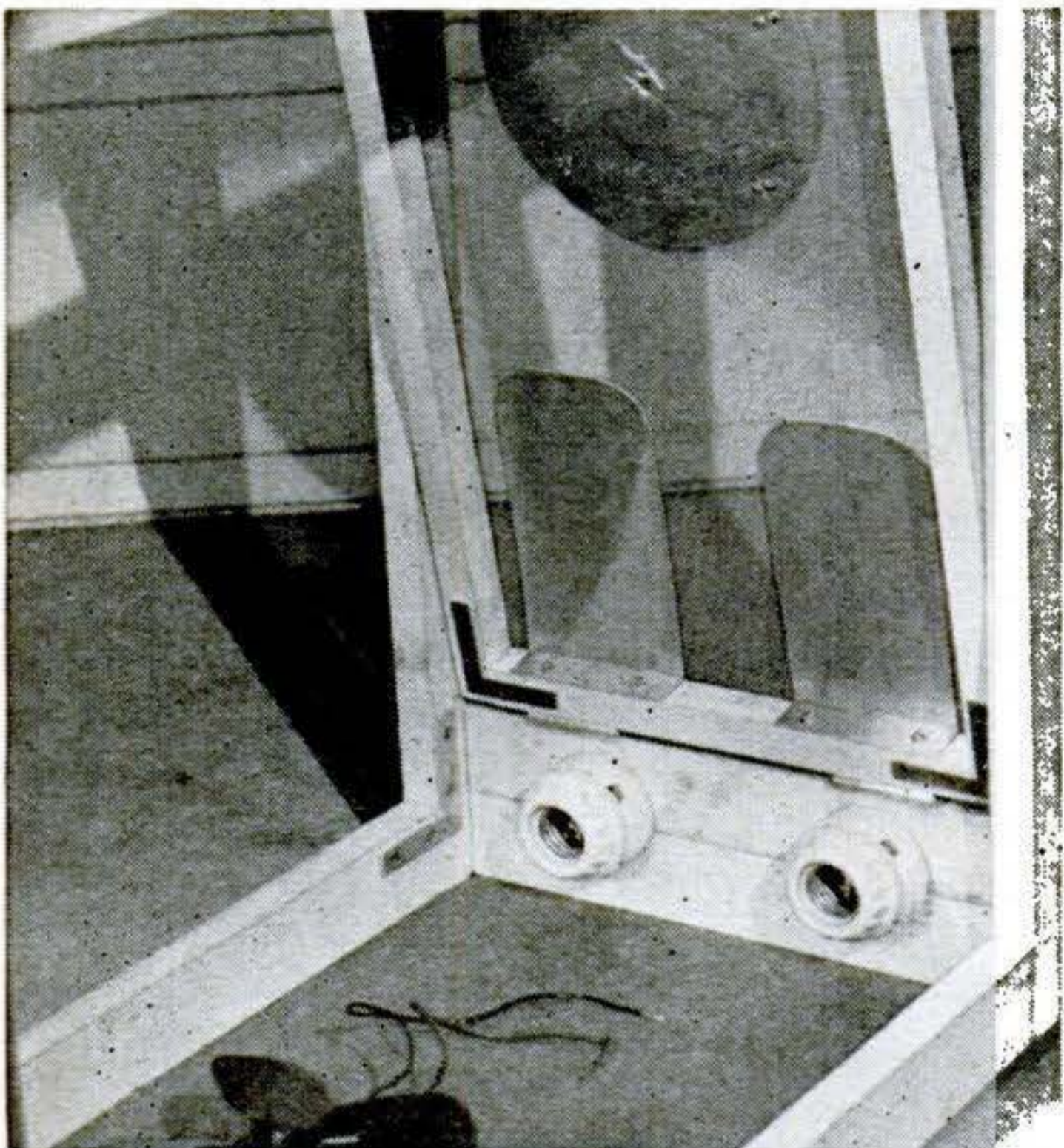

SHIELDS, cut from sheet aluminum, protect bulbs and fan from dripping clothes. False bottom is hinged for access to bulbs and fan.

LINOLEUM CAP MOLDING is nailed all around top and bottom of frame to receive panels. Bottom is lined with aluminum foil.

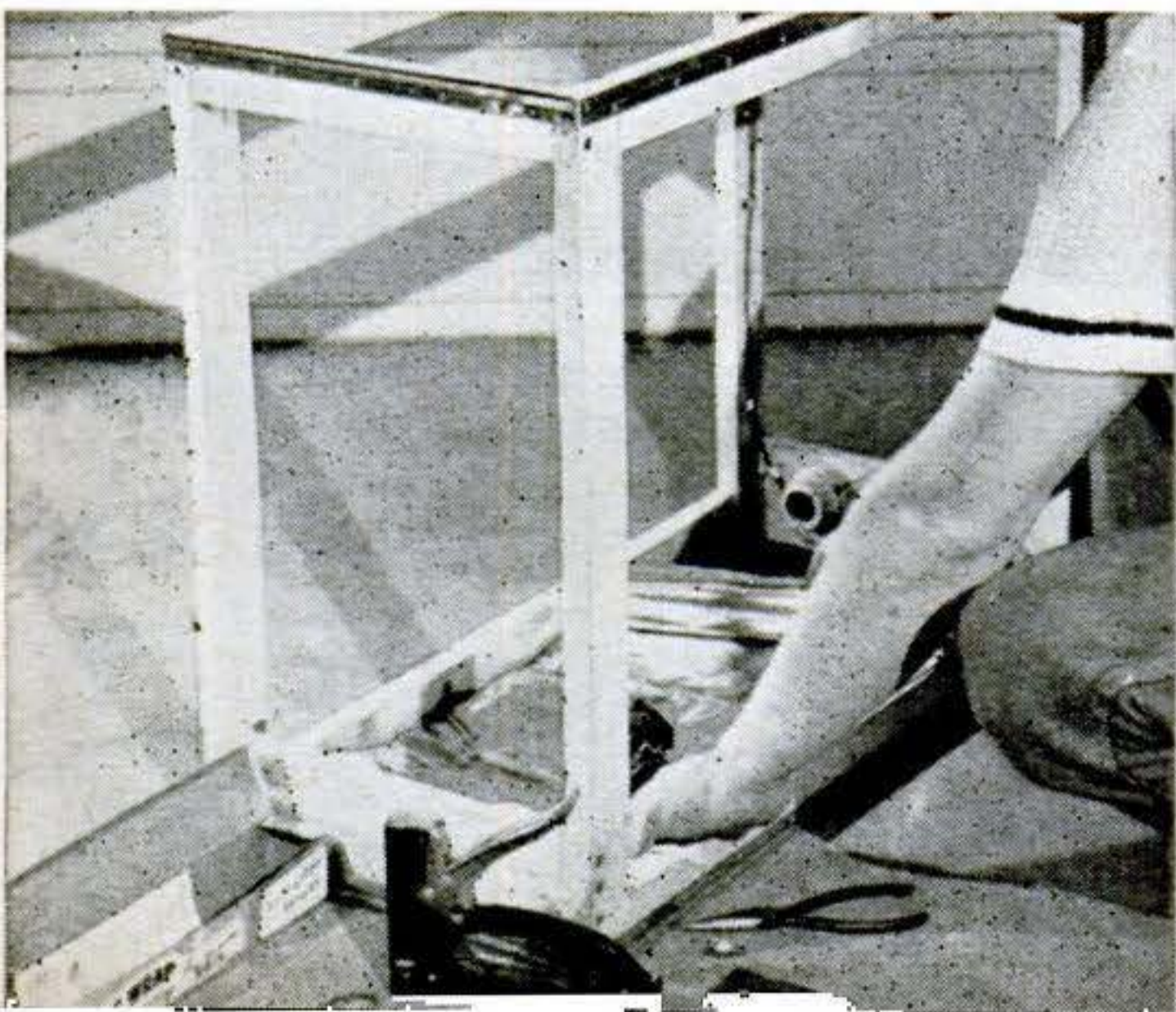

crosspieces to form the sides. The bottom, a piece of $\frac{1}{8}$ " composition board, was nailed on and the frame for the false bottom put together. This was made from pine strips 1" square and joined with flat corner irons to eliminate warping. Galvanized screening was tacked over the false-bottom frame.

Four shields were screwed to the frame of the false bottom to protect the bulbs from drops of water from the wet clothes. The fifth shield, circular in shape, was fastened to the center of the screen with split rivets. This shield also breaks up the breeze from the fan, distributing the heat of the bulbs evenly and preventing the clothes from blowing together and becoming entangled.

Wired for safety. The fan, sockets and wiring were next installed in a parallel circuit so that each would receive full voltage. I used No. 18 solid thermoplastic wire, obtainable at radio-supply stores, to be sure the insulation would not break down under the drying heat. As a safety measure, the feed wires were separated by running one along the front of the box and the other along the rear. The fan was temporarily set in place and its leads soldered to the feed wires. All wire joints were taped with plastic electrical tape, which will withstand high temperatures without breaking down. Any small household fan that will operate in a vertical position will serve. Check on this, as some fans should only be used horizontally.

The switch and plug connection were wired in at this time, to be permanently installed when the sides of the drier were set in place. I used a switch rated for 10 amperes at 125 volts. It should be mounted in a suitable outlet box or covered in some way to protect the terminal screws from contact with wet clothing. I terminated the wiring in a recessed plug connection, eliminating a permanent cord and making it possible to

FAN IS CUSHION-MOUNTED on rubber tape or piece of inner tube after foil is in place. Notice how wires separate to front and rear.



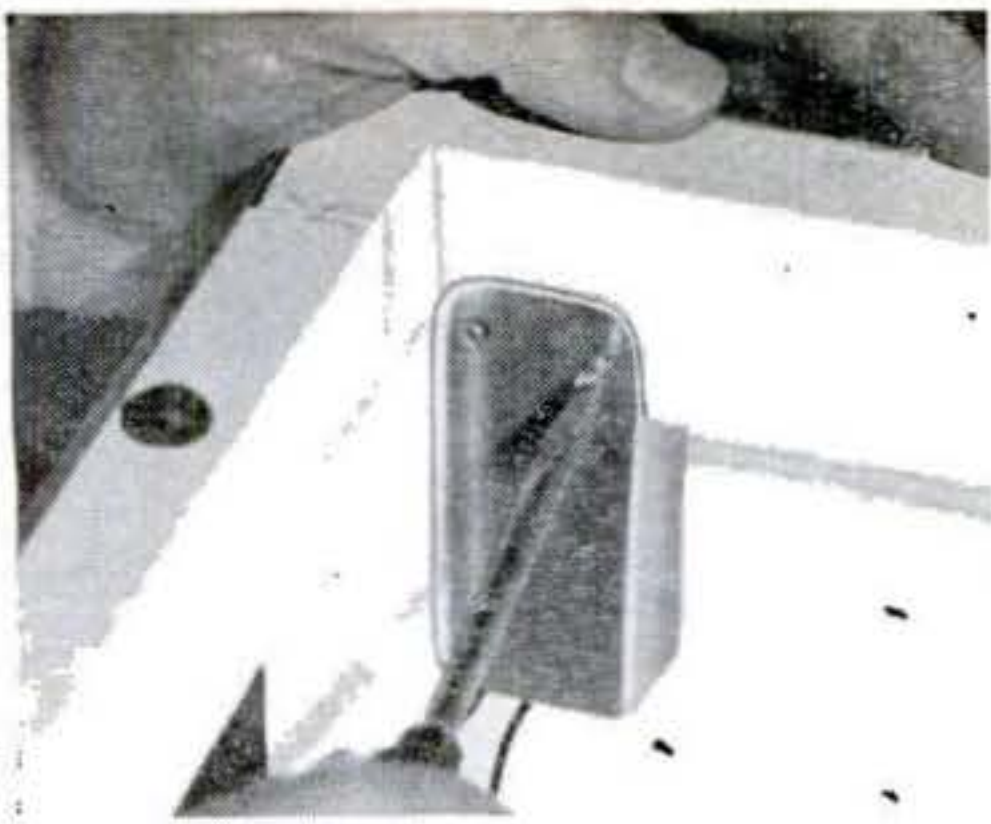

COVER TERMINALS of the switch to prevent accidental contact with hands or wet clothes. Metal cover is lined with electrical tape.

RECESSED OUTLET connects wiring to extension cord, which may be removed and stored beneath false bottom of drier.

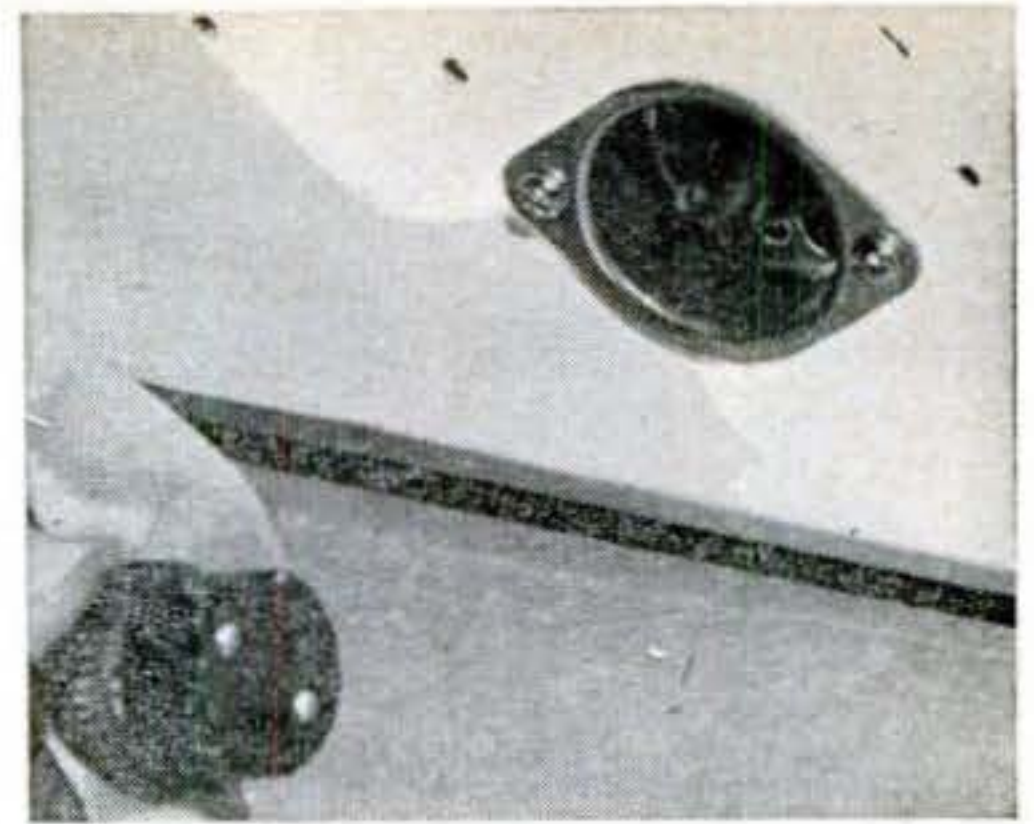

use an ordinary extension cord to connect the drier to the house circuit. The extension may be stored beneath the false bottom when not needed.

After the wiring was completed, I covered the floor with aluminum foil and bolted the fan down for keeps on a cushion mount, cut from an inner tube.

Pegboard. The sides, front and back of the drier were made of $\frac{1}{8}$ " perforated composition board, called "pegboard." It is much used in the window-dressing trade and, though it is slightly more expensive than plain panel, it sure is worth the extra dimes to save all that drilling. To hold the sides, front and back in place, strips of linoleum cap molding were nailed all around the frame, both top and bottom. Then the panels were sprung in place by bowing them out to insert them in the molding. The corners were finished off with linoleum corner molding.

You'll find the job a whole lot easier if you prime and paint the panels before you install them. If possible, spray the paint on to avoid filling the perforations. Use white on the inside for maximum heat reflection. Don't paint below the underside of the false bottom, as heat from the bulbs may cause blistering.

Cover. Plywood, $\frac{1}{2}$ " thick, was used for the cover of the drier. The edges may be rounded off by sanding, or they may be covered by nailing molding strip or beading all around. Two rubber-headed nails were set on the upper front rail of the frame to balance the thickness of the hinges, which should not be set in either frame or cover. This leaves an air space at the top.

The drying rack was constructed of welding rods, soldered together. Steel rod $\frac{1}{8}$ " in diameter will do as well. The pieces were cut to length, laid out and tacked to a flat surface. Solder was applied liberally on each joint and excess later taken off with an electric hand grinder; a round file can be

used. Four screw eyes, cut to form hooks, support the drier rack, which is hung on the two rear hooks when not in use.

A rack may be made of $\frac{3}{8}$ " dowels set in 1" by 1" endpieces, but it will be rather cumbersome in such a small space.

Small ball casters were hammered into the four bottom corners and chrome handles were fitted to the sides to dress the job up a bit.

A fast bulb-snatching tour rounded up four 100-watt bulbs and the drier was officially open for business.

You'll find, when using the drier, that drying time will vary from 45 minutes to two hours depending upon the humidity. **END**

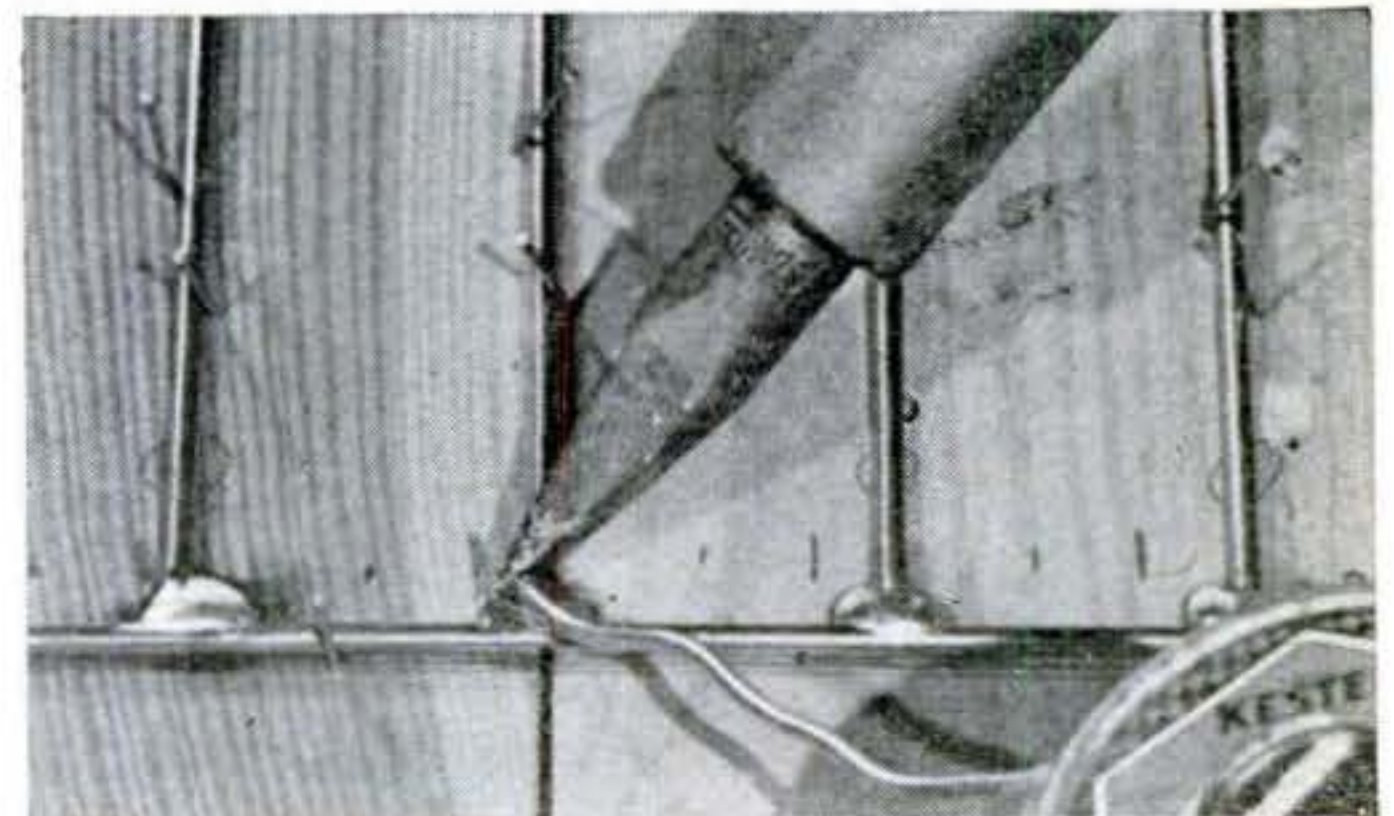

DRYING RACK is assembled from welding rods or $\frac{1}{8}$ " steel rods. Lay out and tack them in position prior to soldering, as above.

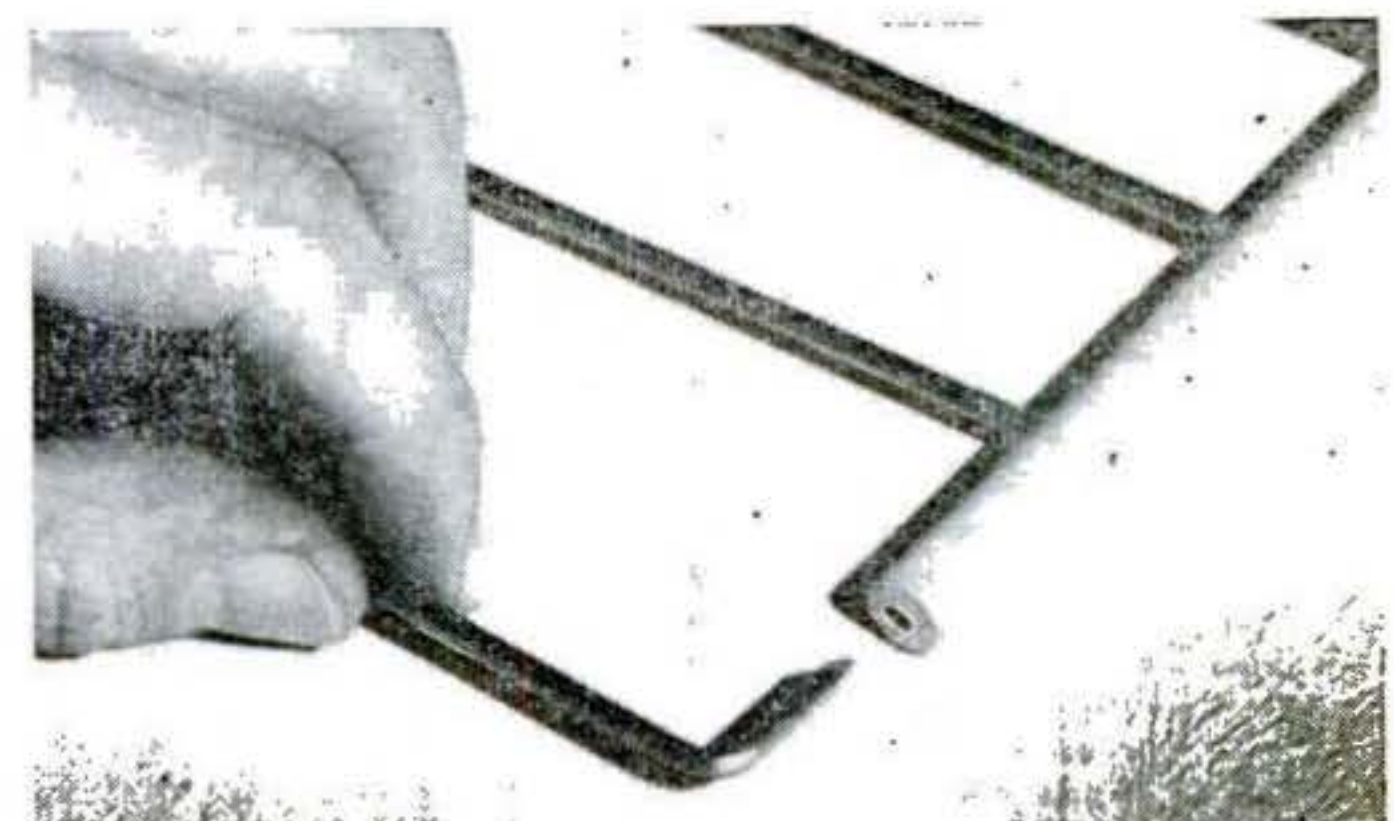

ALTERNATIVE METHOD of constructing drying rack uses steel rods forced into undersize holes in two dowel endpieces.

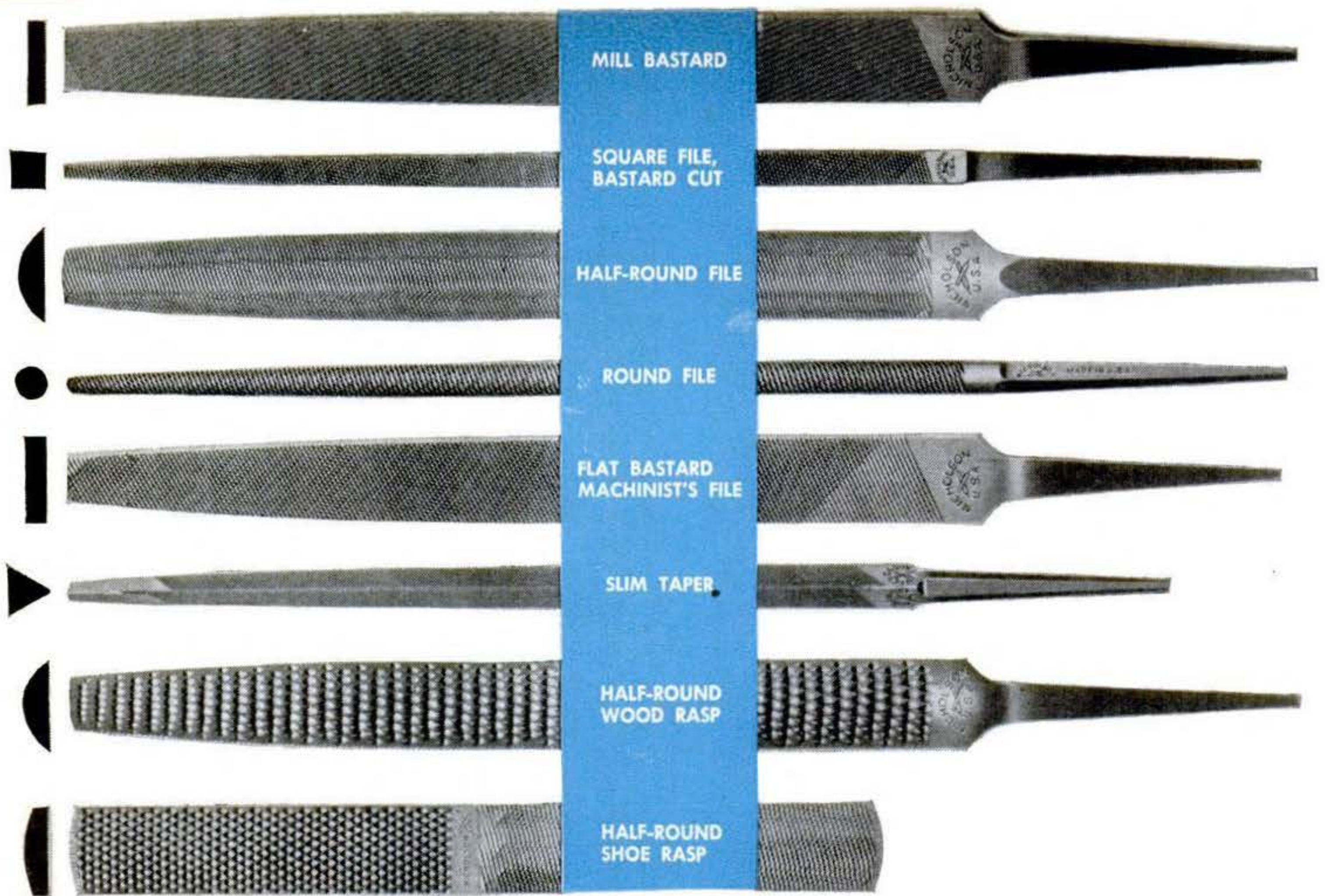

Get Acquainted with Files

Out of hundreds that exist, do you know which is right for your job? Here's how to choose, use and care for them.

By Steve Mashek

EVER since some cave man found that he could sharpen a stone by rubbing it with a harder one, we've been using and improving his technique. Metal, it was found, could be worked with harder metals, and eventually teeth were added to make the tool work faster.

Hundreds of types, shapes and sizes of files are needed nowadays. Few workmen

need to become familiar with all of these varieties, but everyone who uses tools should be well acquainted with the most common kinds.

Looks are deceiving. At first glance, these industrial back scratchers seem to be all alike, except for their shape. The big difference, though, is in the cut. Some are *double-cut*, others *single-cut*. Degree of coarseness is listed in order: rough, coarse, bastard, second-cut (not to be confused with double-cut), smooth and dead-smooth.

Names tell the story. File names usually indicate the type of cut. *Machinist's files*, which head the list as all-around, fast-work-



SINGLE-CUT. One series of diagonal cuts (left) forms long teeth that work with shearing action. Smooth but slow.

DOUBLE-CUT. Two series of opposing diagonal cuts (right) form diamond pattern of thousands of pointed teeth. Fast working but rougher.



ing tools, are double-cut. They are ordered by name, shape and length. For example: to buy a flat file for fast cutting without regard for finish, you should ask for a 10" flat *bastard machinist's file*. The length is the actual body of the file, not including the tang or narrow portion that is fitted with a handle.

Common machinist's-file shapes are:

- Flat file; has teeth on both sides and edges; tapers slightly in width and thickness.
- Hand file; often used for finishing, is similar to flat file, but has one safe or uncut edge.
- Round file; used for circular openings and curved surfaces.
- Half-round file; saves changing files when working on irregular surfaces.
- Square file; used for slots, keyways and surfaces. These are tapered, but do not come to a point.
- Three-square file; triangular in shape, it gets into internal angles and sharp corners.
- Knife file; resembles a knife blade, permits working in acute angles.
- Warding file; tapers to a point in width, but is uniform in thickness. Well suited for filing in narrow spaces.

Mill files, designed to sharpen saws and cutting tools, are useful for lathe work, drawfiling and all work requiring a smooth finish. Mill files are single-cut and work slower but much smoother than machinist's files. The usual shop mill file is flat, tapering in width. The saw sharpeners are the tapered, slim-tapered, and blunt triangular files. Another is the round-edge *cross-cut file*, which is used to deepen the gullets between circular-saw teeth.

Wood files have teeth that are similar to those of machinist's files but are much coarser and differ sharply from the wood rasps. Rasp teeth, unlike those of files, are individually formed and not connected. The coarsest, made in flat, half-round and round shapes, is the *wood rasp*, used by wheel-

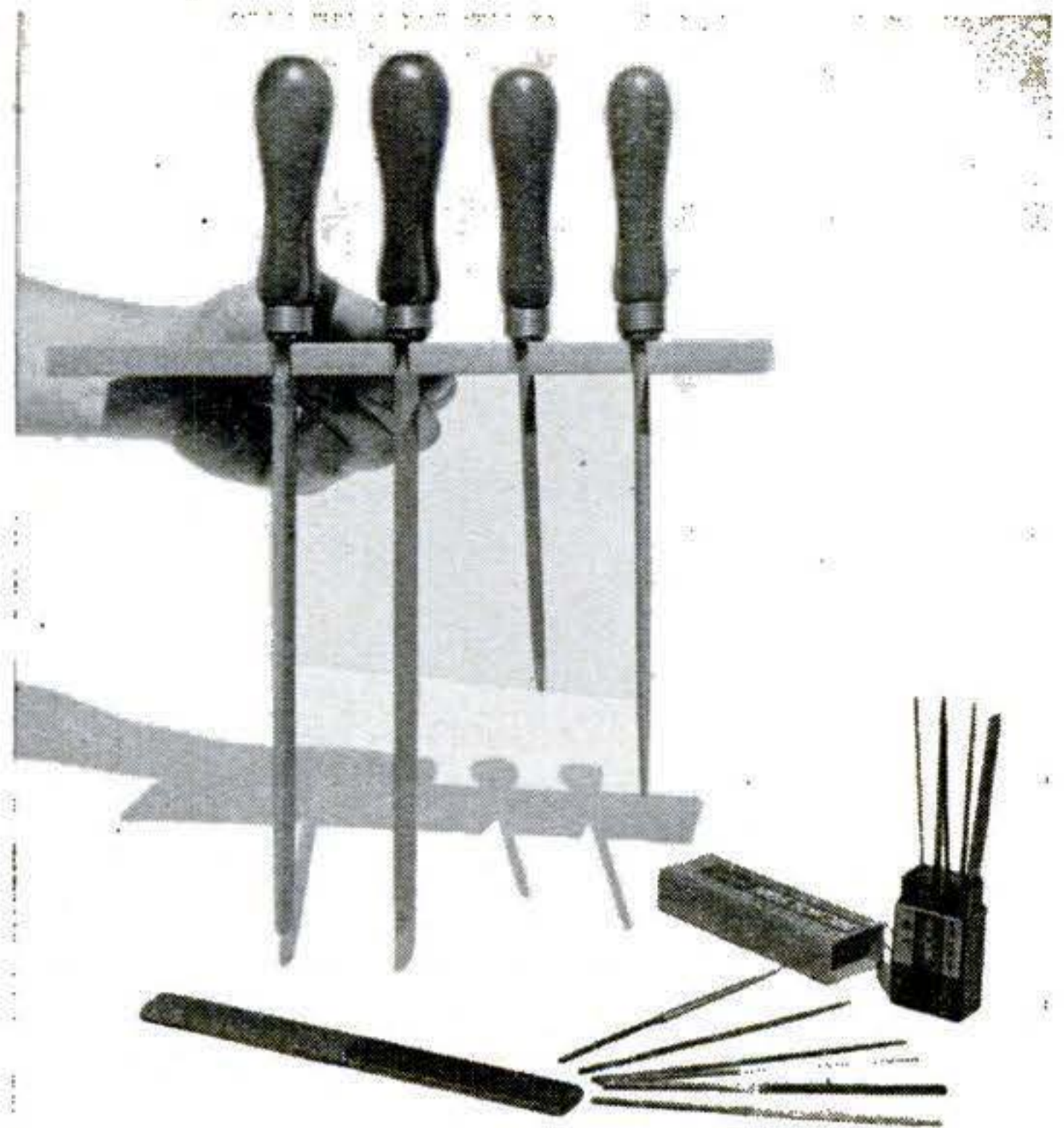

GOOD BEGINNING for a collection of files: In rack (left to right)—10" flat bastard, 10" mill bastard, 6" slim taper, 8" round bastard. On bench—8" half-round shoe rasp and set of 5½" Swiss pattern files. Notched board is fastened to wall for convenient rack.

wrights, woodworkers and plumbers. Too coarse for the typical home job, it is often purchased by the man who really wants the smoother-working *cabinet rasp*. Even smoother in its cutting action is the *pattern-maker's rasp*, made only in half-round.

The *horse rasp*, also much too coarse for the home shop, has a milder counterpart in the *shoe rasp*, a combination rasp and file made double-ended in half-round and flat section.

Curved-tooth files are somewhat specialized for home use unless you do your own automobile-fender work. The curved teeth readily clear themselves of chips, a necessary feature on soft material. Rigid ones come with or without tangs, and there are flexible types, with a hole in each end, for use in a special holder that bends them to any reasonable radius for working in

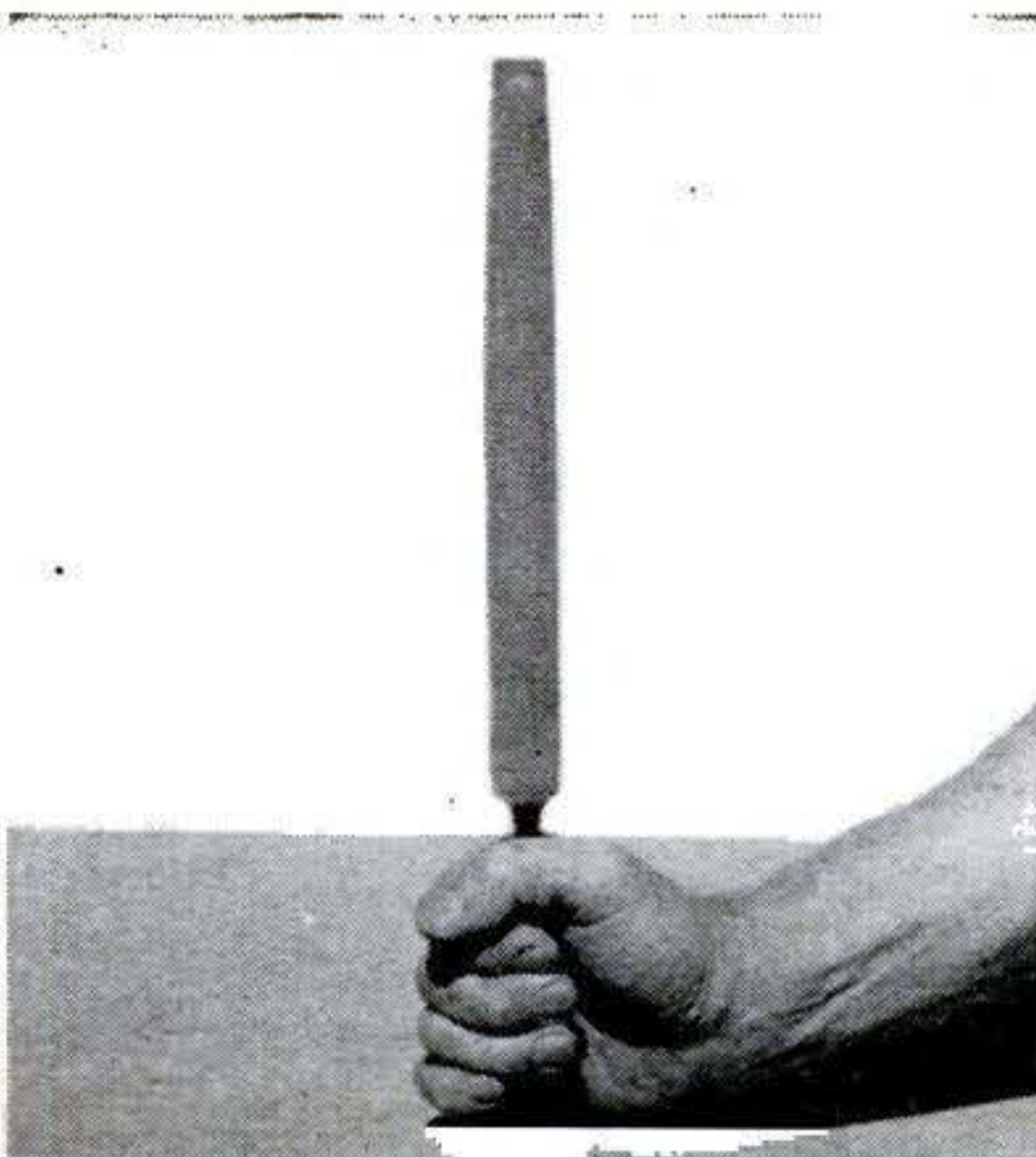

DON'T HAMMER a file into a handle. Push tang in and rap handle smartly on bench (left) until file seats itself securely.

CLEAN FILES will cut faster and leave no scratches. File brush (right) does job.

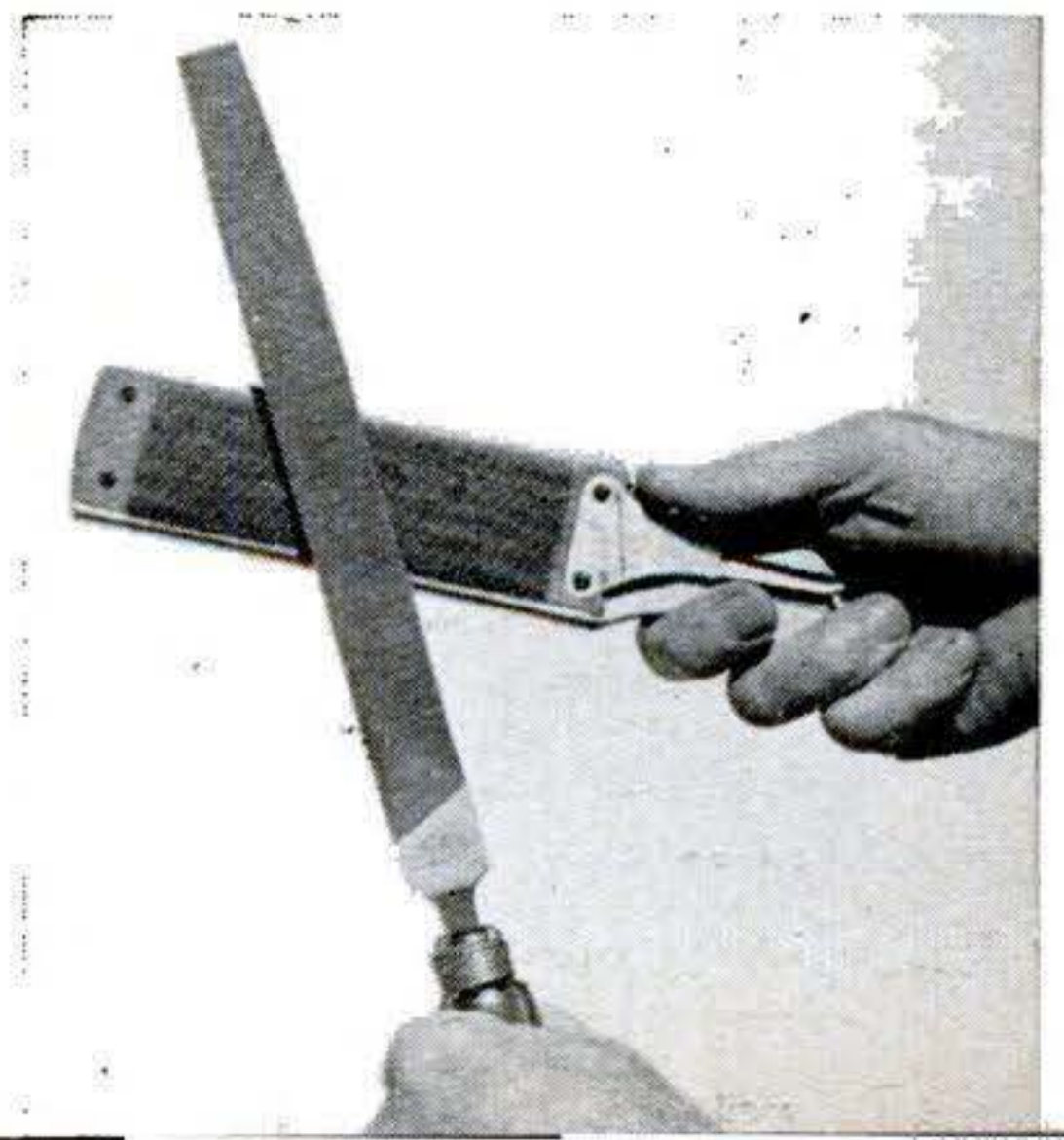

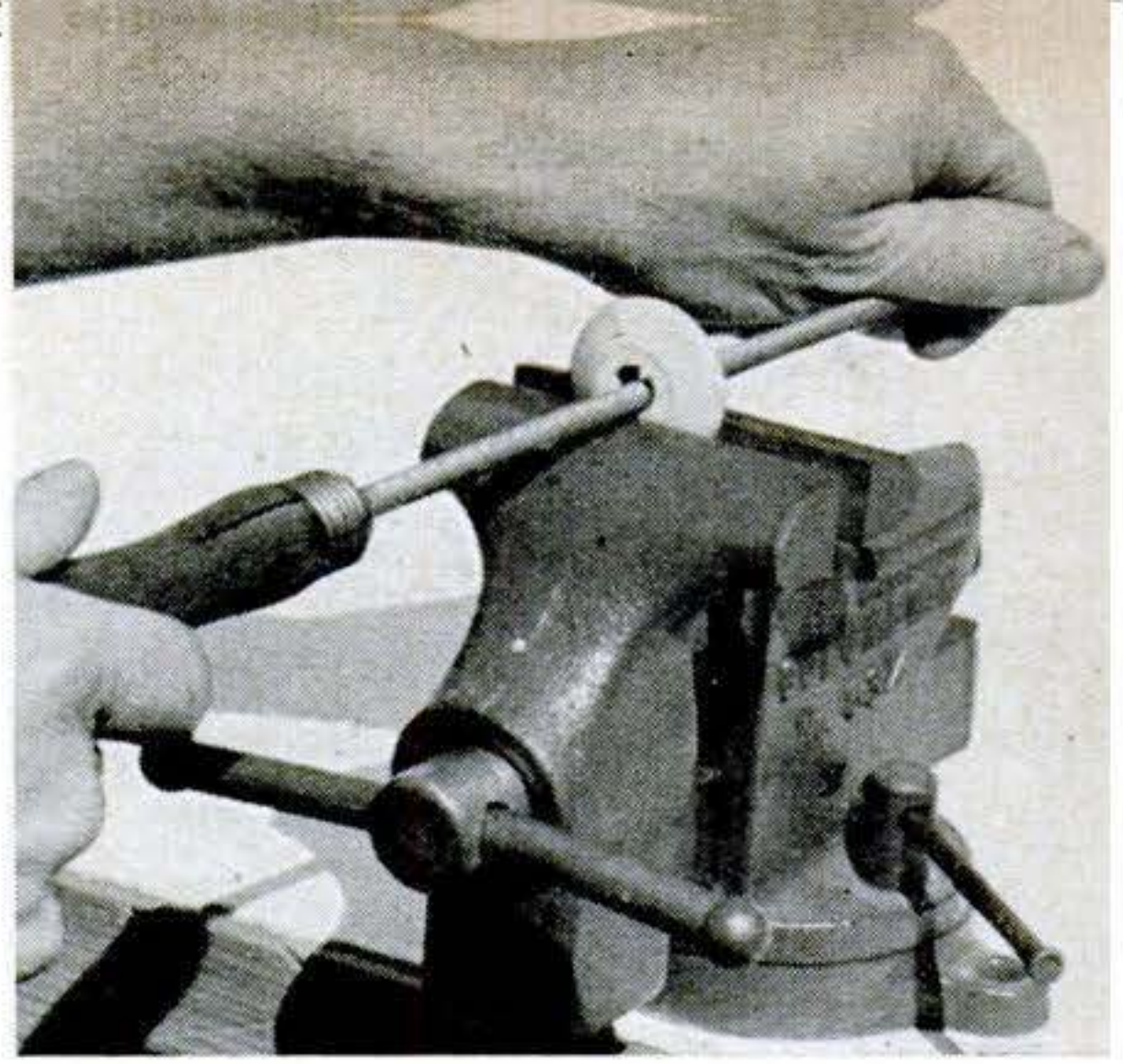
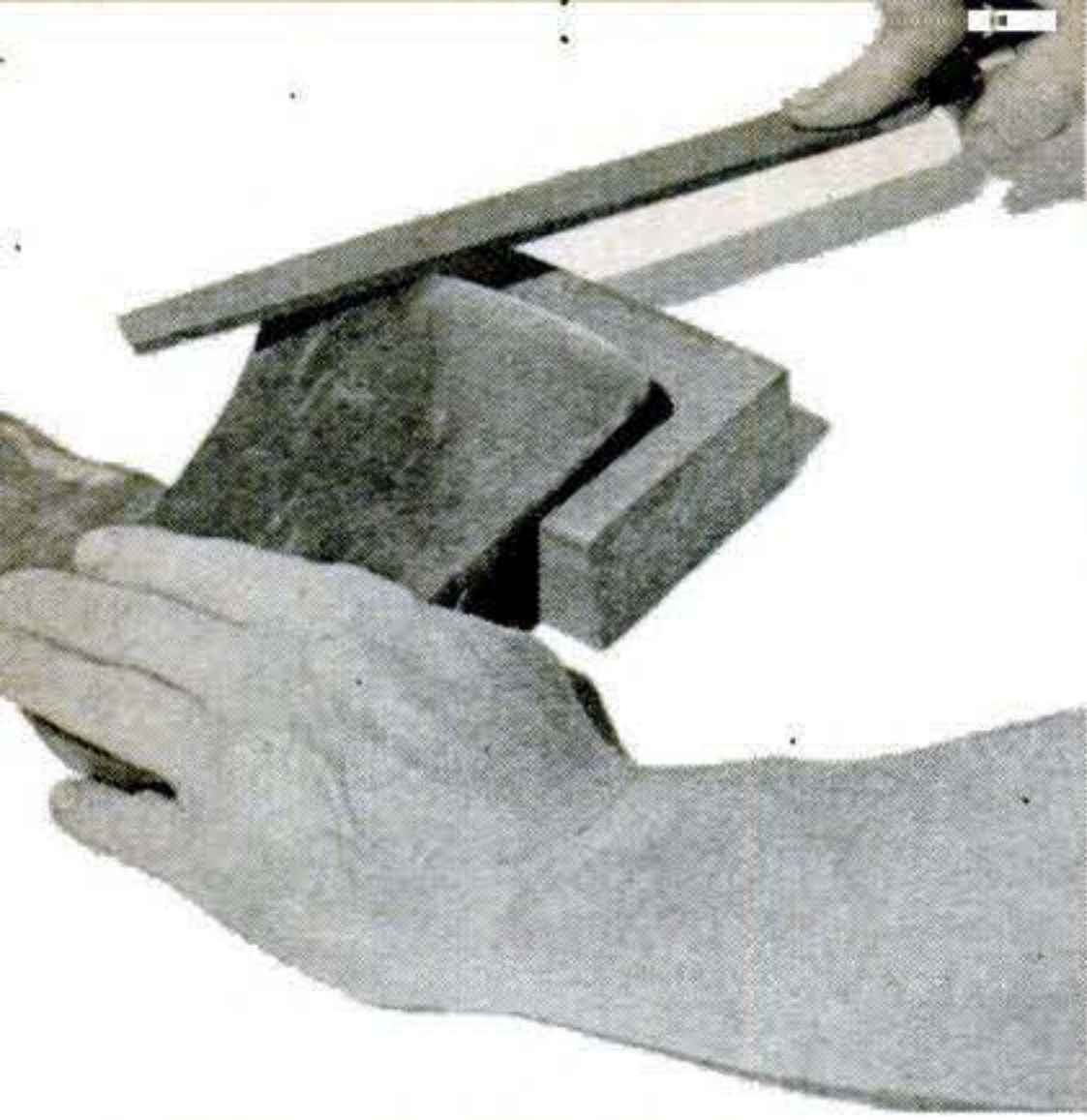

NICKS ARE REMOVED from ax with 10" flat bastard machinist's file, as this job calls for taking off quite a bit of metal with little regard for the finish of the work.

GENERAL SHARPENING and finishing are done by mill bastard. Use it to renew edge on garden tools and mower blades and to finish work requiring smooth surface.

ENLARGE A HOLE or fit a door lock with the round file. It is particularly useful for filing concave surfaces and for profiling — filing irregular shapes on edges of work.

concave areas. Shapes are flat, half-oval and half-round.

Swiss pattern files are made in a great variety of accurately formed shapes in very fine cuts. They are most often used in smaller sizes for delicate work.

Special-purpose files are numerous but seldom needed in the home shop. It doesn't hurt a bit, however, to know that they exist. There are *foundry files*, for cleaning up rough castings, *die-cast files* for removing flashing or sharp corners on die castings, and double-end files, called *rifflers*, with pointed ends shaped in a wide assortment of curves for use by die sinkers and silver-smiths.

Other files, made for specific materials, carry inscriptions such as "for stainless steel" stamped on their tangs.

Use files properly. If you've learned to select the right file, half the battle is won. The other half is learning to use it properly. Most work is best done at about elbow height, clamped in a good vise.

Beginners naturally rock a file across the work seesaw fashion. But to obtain a level surface, the file must be pushed forward in as close to a horizontal plane as possible. Push just hard enough to keep the file cutting all the time. Too much pressure is likely to chip or clog the teeth of the file. Too little will allow the file to slide over the metal, dulling the teeth rapidly. It is good practice to lift the file clear of the work on the return stroke. The exception to this rule is *drawfiling*, a method of pushing and pulling the file sideways across the work to produce a fine finish. A single-cut file is best suited for this work

Lathe filing is another smoothing process in which the file is stroked against work revolving in the lathe. The flat mill is quite capable of handling most lathe-filing jobs, but there is a special *long-angle lathe file* with teeth cut on a longer diagonal than those on the mill file. This longer angle produces a clean, shearing cut and reduces clogging. A light touch with a long-angle lathe file brings the work to maximum smoothness. Both edges of this file are safe, permitting you to file right up to shoulders on the work.

Files require very little attention compared with other cutting tools. To make your files safer and easier to use, handles should be fitted to the tangs. A rack will keep files handy and prevent dulling from contact with other files. Files carried in a car or tool chest should be protected by individual wrappers of cloth or paper.

Clean files often. A clean file cuts faster and leaves no scratches. Rub a file brush or card across the file for general cleaning. Use a pointed scorer for picking out the stubborn chips. You can buy a file cleaner combining all three types. Oddly enough, both rust and grease are enemies of the file. Rust eats the teeth away, rendering them useless, and grease encourages clogging. To avoid rust, keep the files clean and store them in a dry place. To remove grease and oil, rub the files with chalk and go over them with a brush. These small efforts are well repaid in better work more easily done with tools that really cut. **END**

Engraving jewelry interest you? See PS next month and learn to cut a monogram.

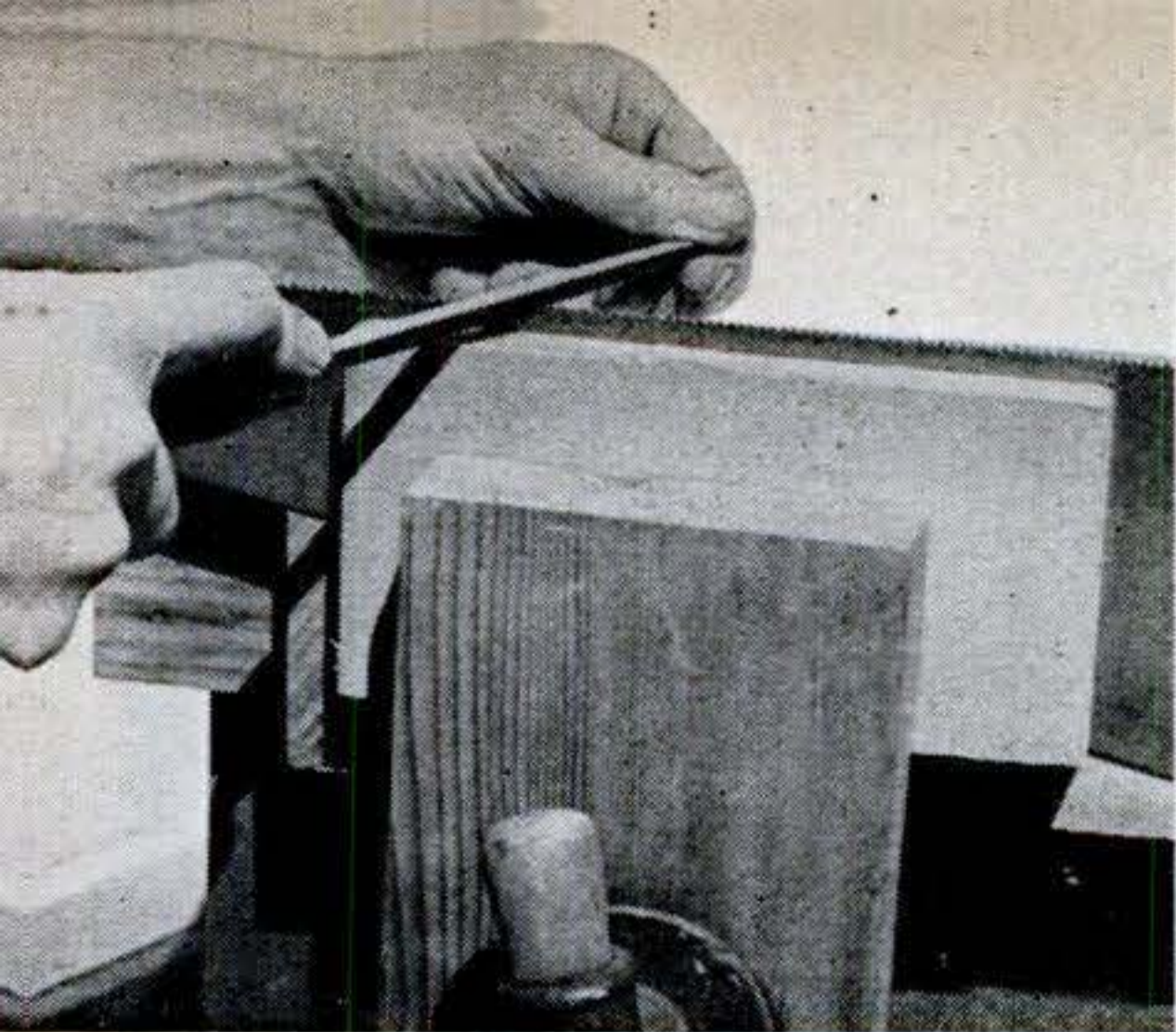

A SLIM TAPER FILE at work sharpening a saw. Two blocks of wood are used in a bench vise to clamp the saw in the absence of a special saw vise.

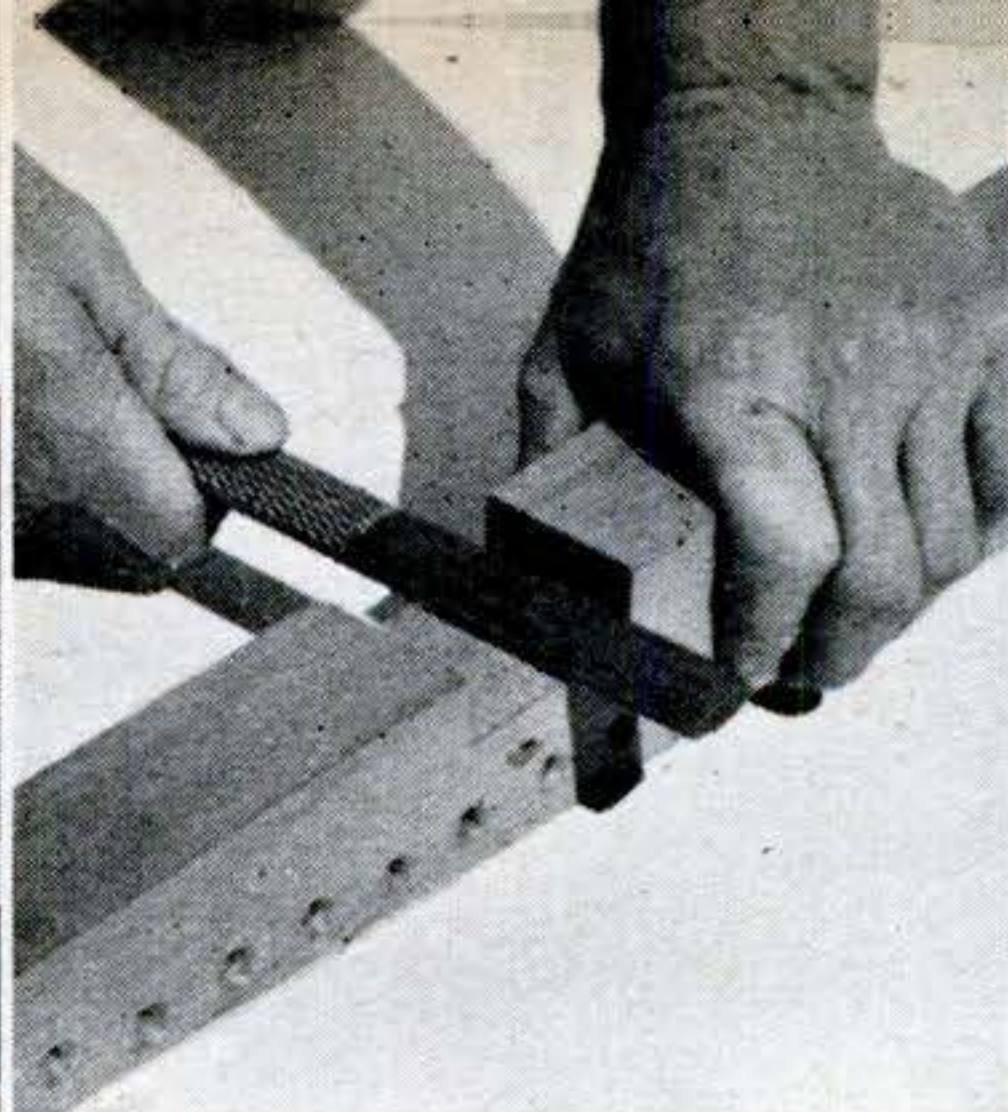

WOOD PARTS are quickly shaped with the half-round shoe rasp. A wood rasp or cabinet rasp is excellent for finishing wood joints, particularly on end grain.

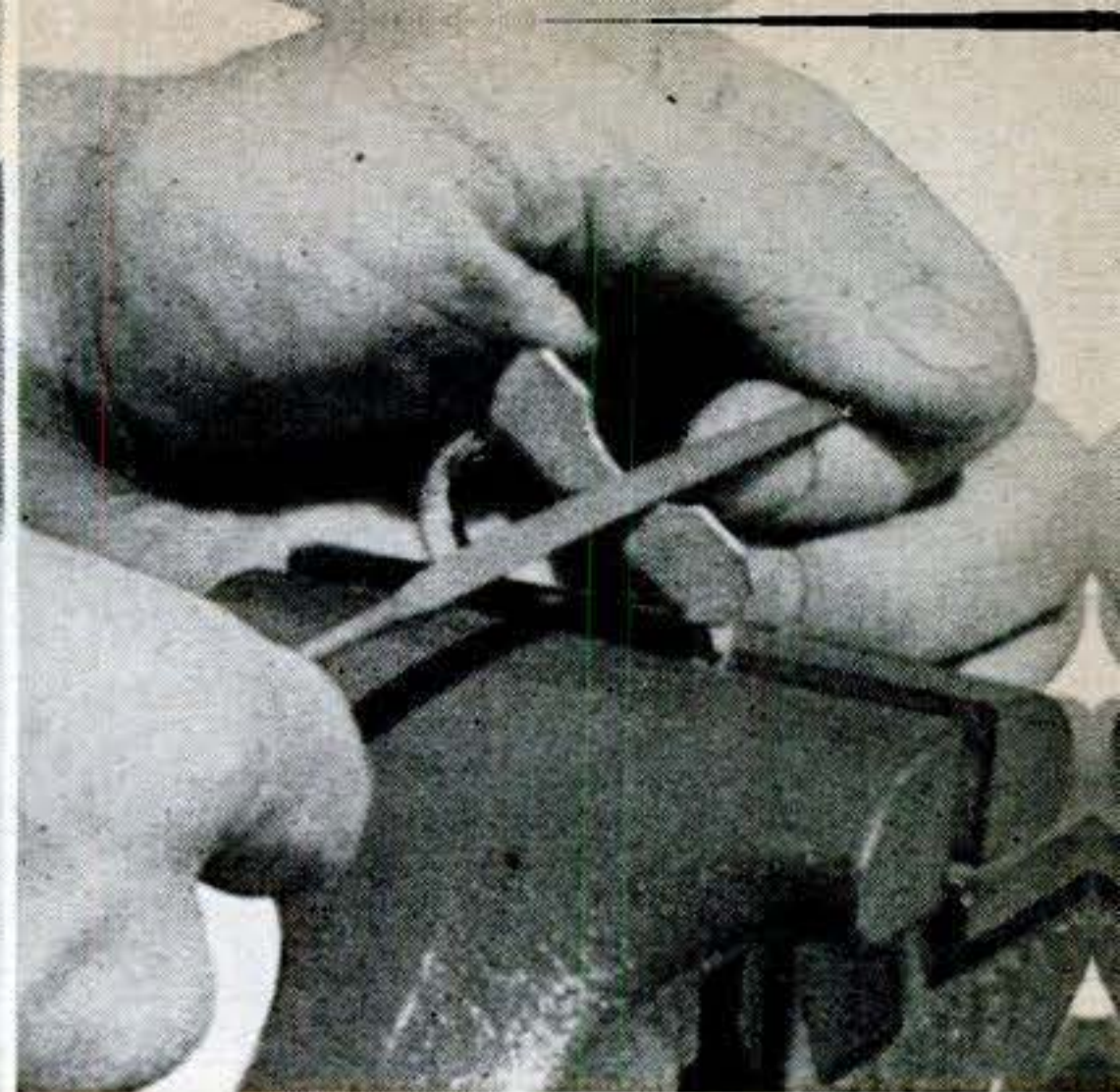

SWISS PATTERN FILES, made in a wide variety of accurately formed shapes, are ideal for model and die work. They are favorite tool of instrument makers.

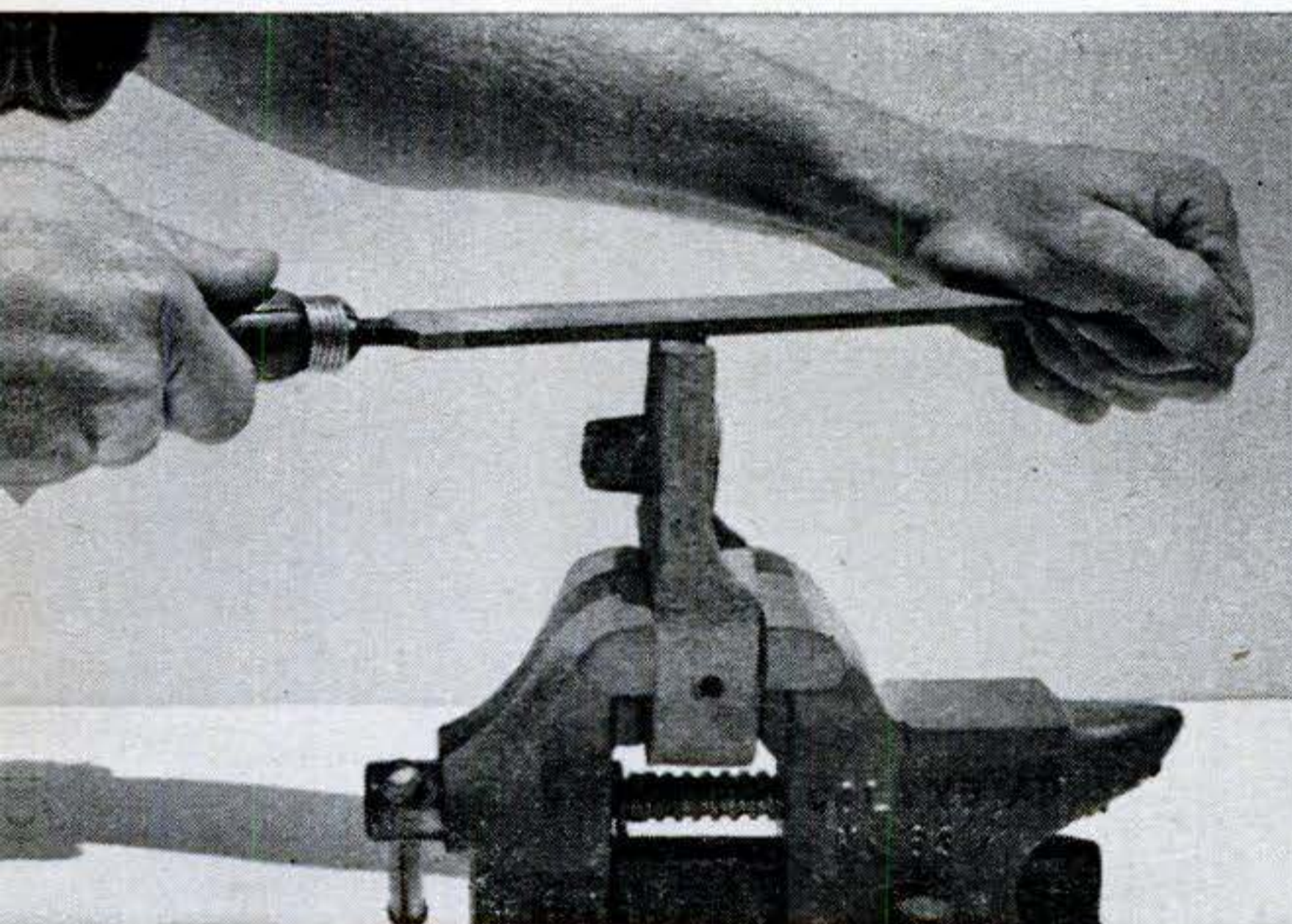

HERE'S A GOOD GRIP for heavy filing. Have work at elbow height and stand erect to avoid rocking-horse strokes.

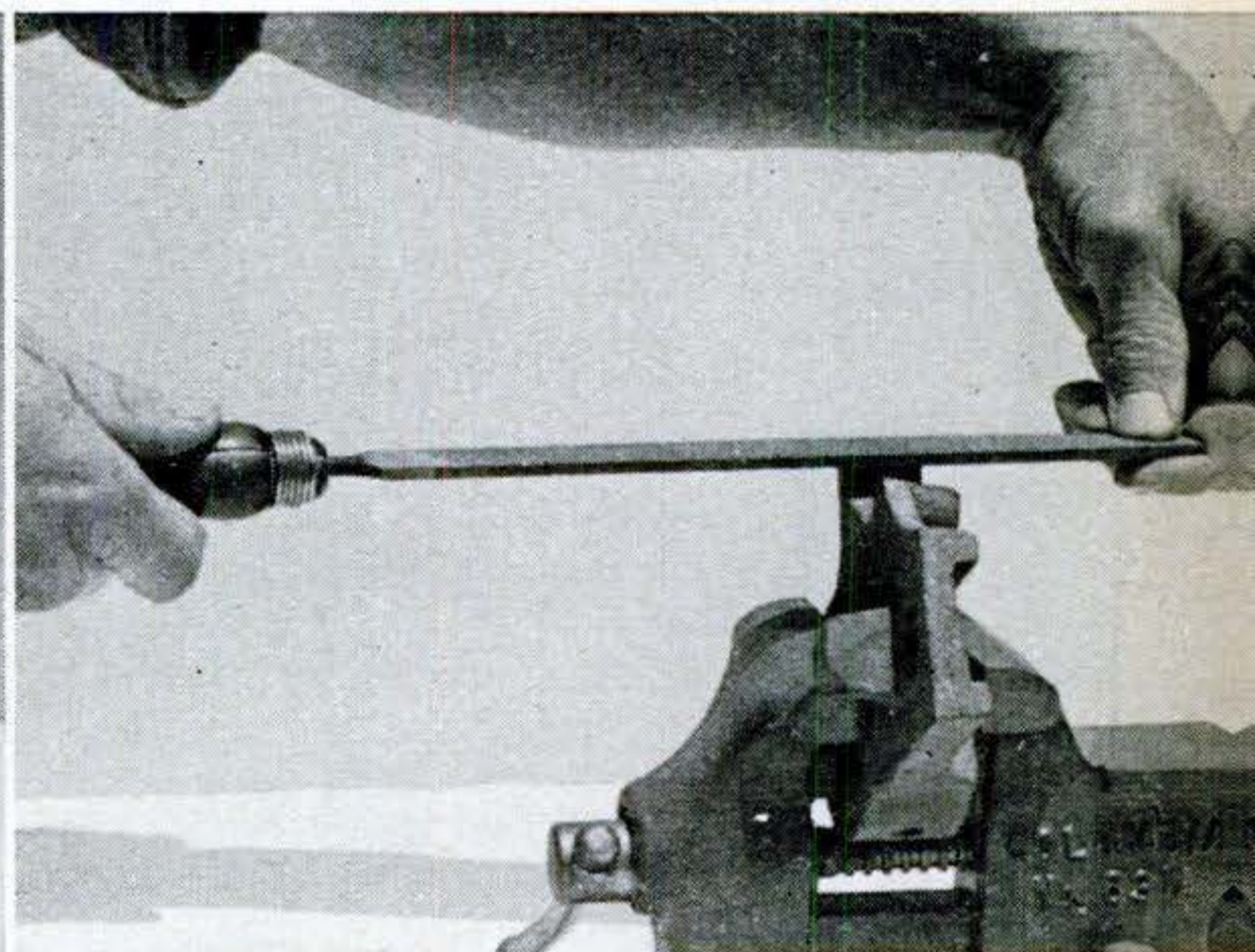

LIGHT FILING and finishing is done with a sensitive, two-finger grip on the end of the file. Lift file on return stroke.

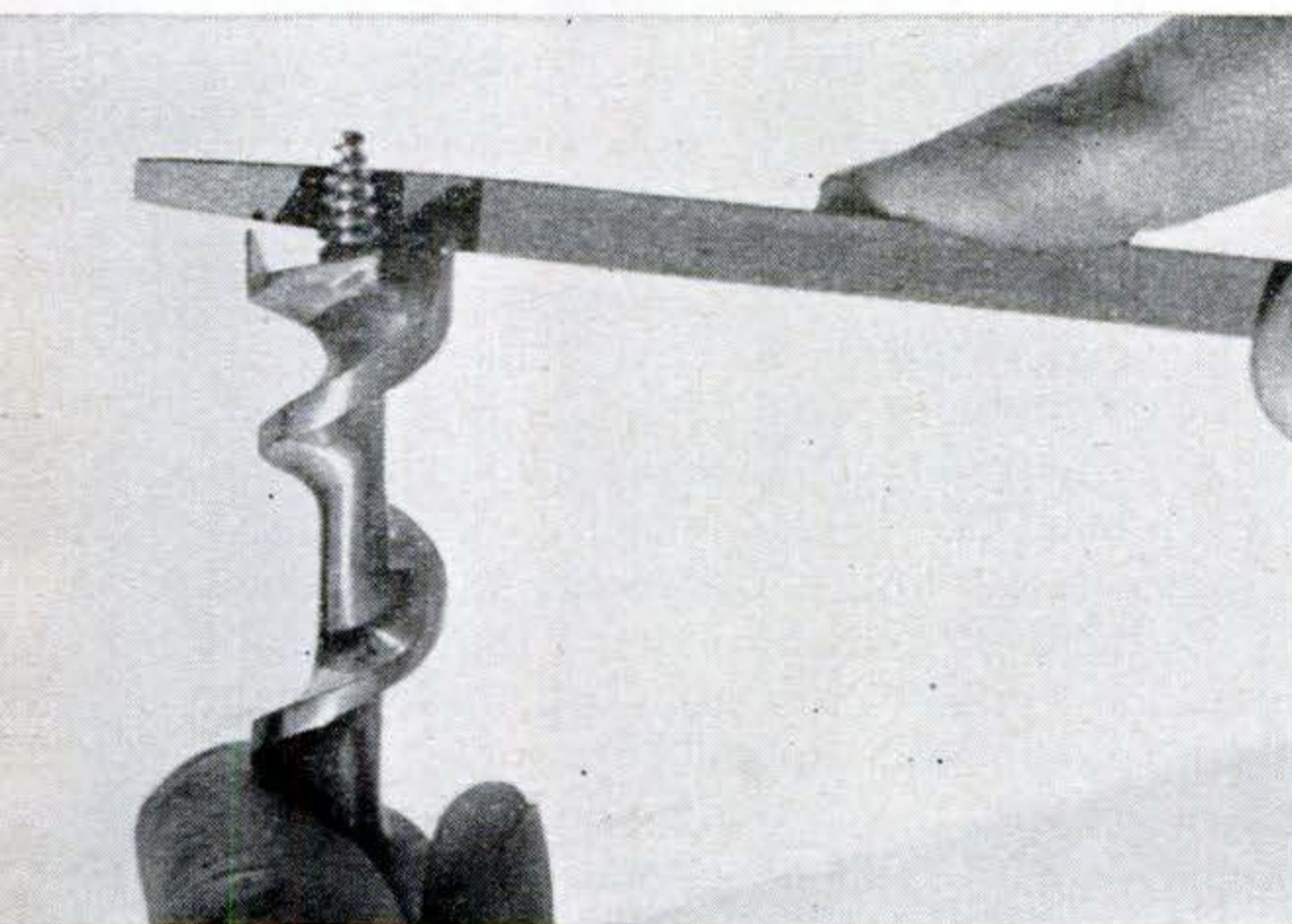

ONE-HAND GRIP, with first finger extended for control, is best for sharpening tools not held in a vise. Choice for this job is auger-bit file made for the purpose.

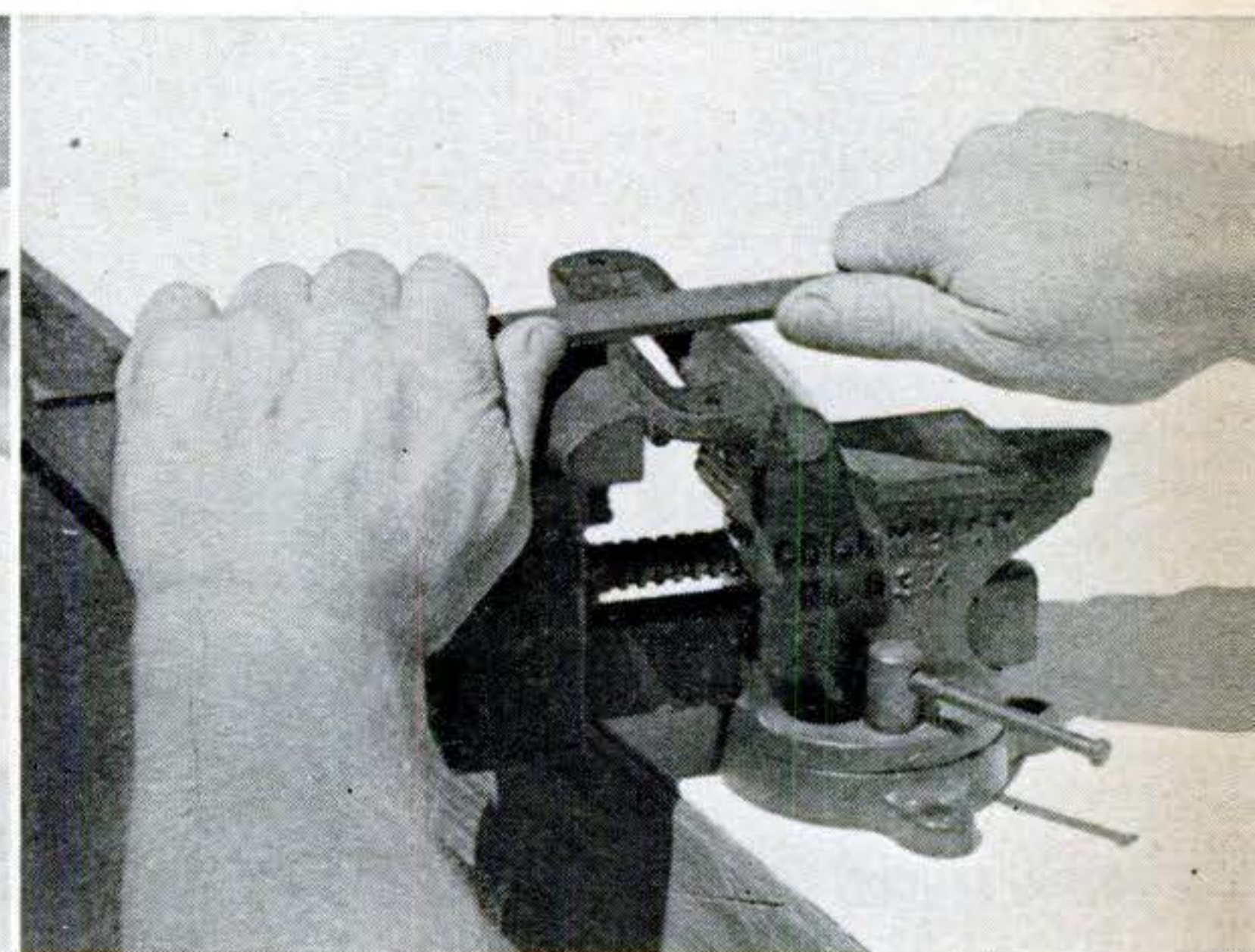

DRAWFILING, done with a mill bastard, is the way to a finer finish. The two-hand grip, with thumbs behind the file, guides it back and forth over the work.

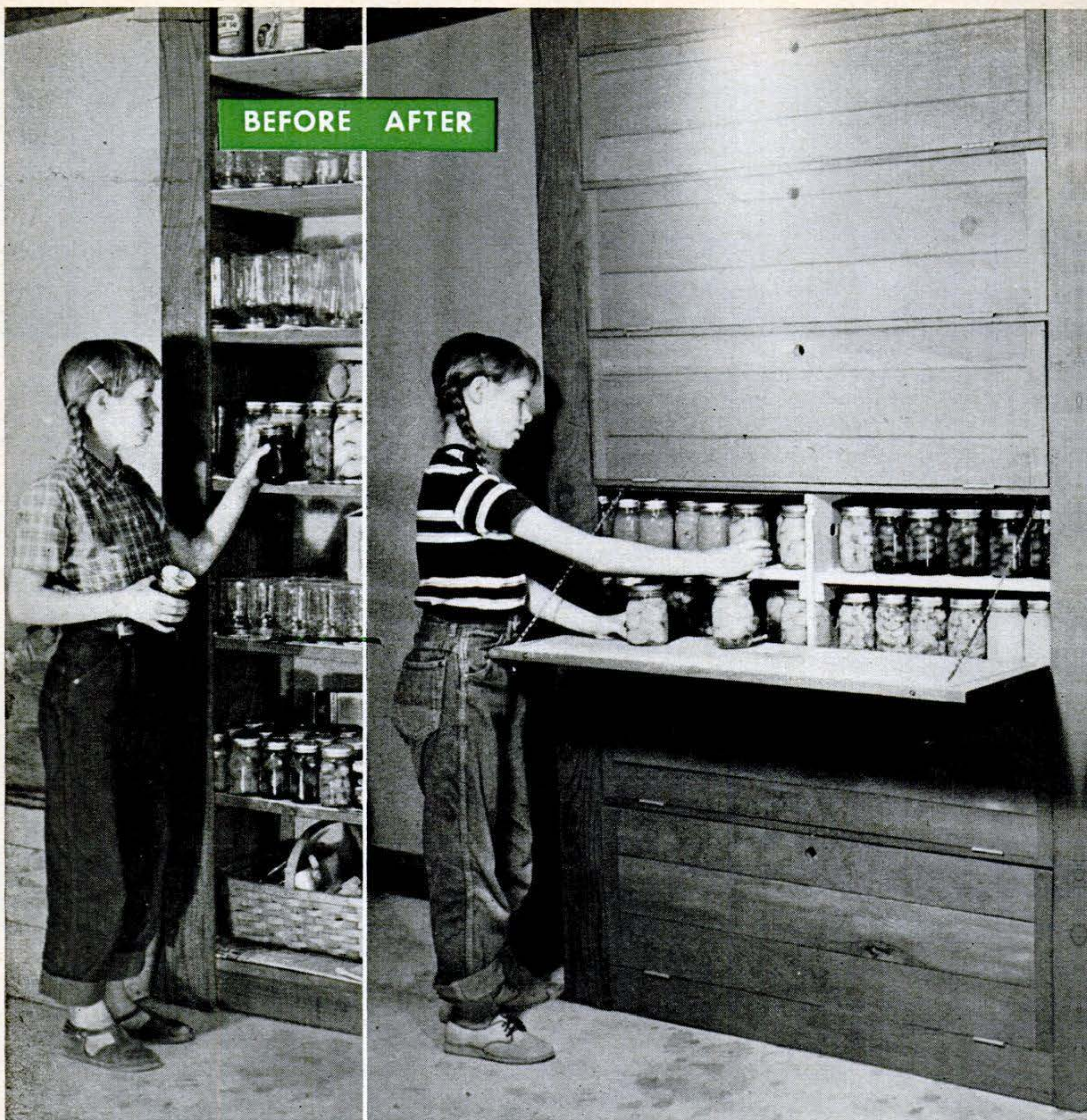

Get More Out of Basement Shelves

How to remodel that preserve closet to get greater usable area and more working convenience.

By Paul Corey

190 POPULAR SCIENCE

WHEN you have wanted to take something from the back of a crowded shelf, you've probably wished for an extra hand. That's why I built a helping hand right on each pair of shelves when I added shelf space in our utility-room storage cabinet.

Instead of vertical doors, I built horizontal doors on the cabinet. They are hinged to drop down and are held flat—like an open hand—by chains, giving you space to put articles while you select an armful from the shelf.

Getting more space meant adding intermediate shelves between the widely spaced shelves already there.

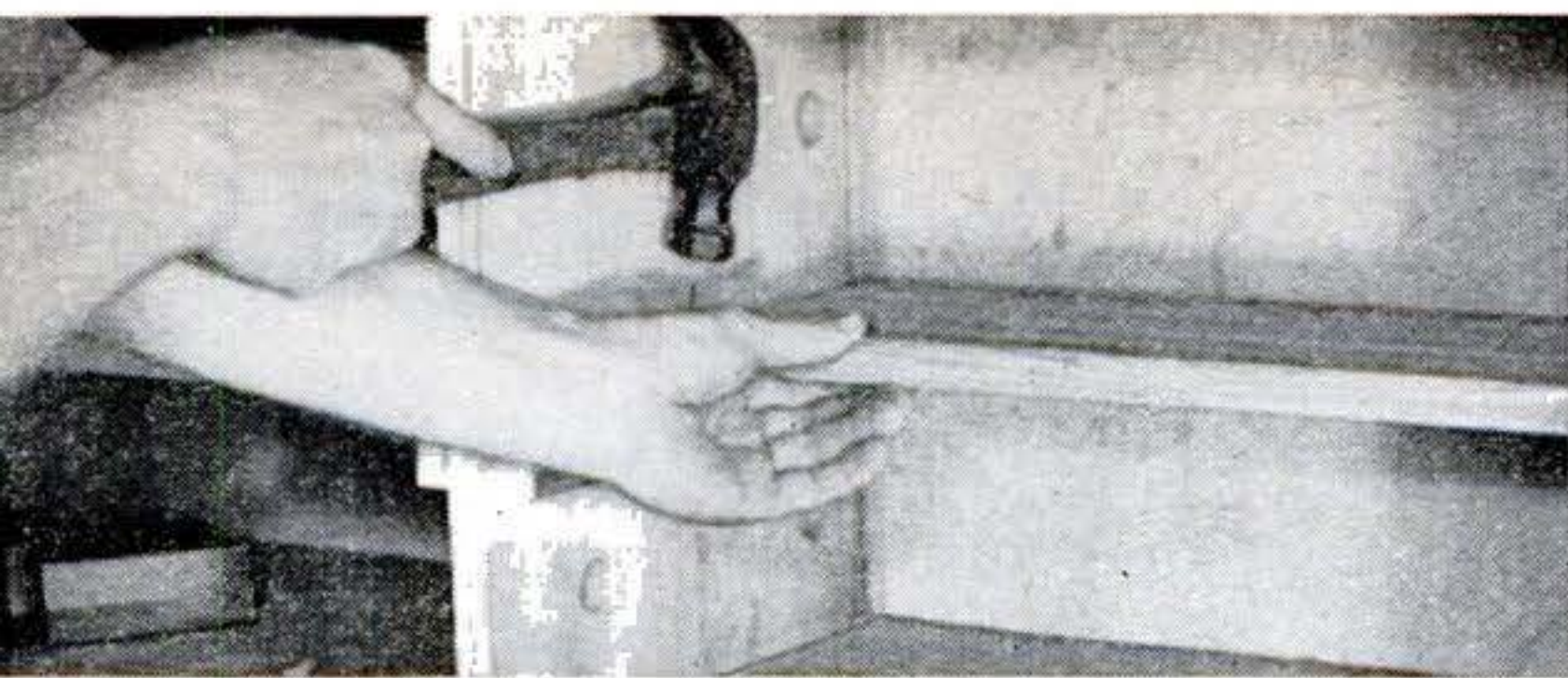

NEW SHELVES were added between the old ones, doubling the usable space. Holes were bored in side walls to improve air circulation.



STRIPS WERE NAILED and glued to ends of vertical doors to keep doors from warping. The reinforcing strips measured 1" by 1½".



TWO LENGTHS of sash chain were fastened by screw eyes to hold doors flat when open. Chains run from shelf to inside of door.

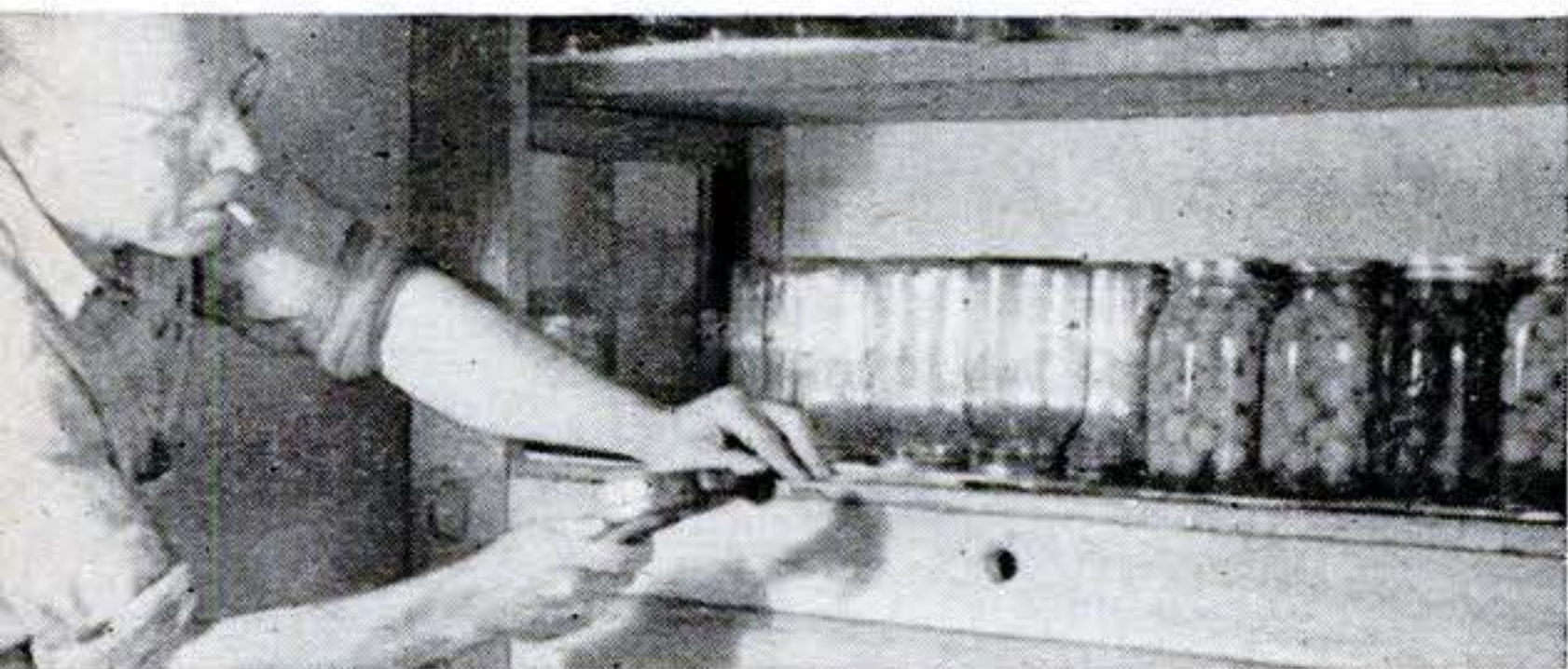

WOOD STRIPS ¾" by ¾"—with bullet-catch cups on bottom and hinge mortises on top—were nailed to every other shelf.



Cupolas Are His Business

CUPOLAS to perch on roofs are the product of Frank Smith's woodworking shop in Independence, Ohio. Built mostly of wood, they are topped with composition roofing or copper. Surmounting the cupolas are weathervanes and compass points jigsawed from hard composition board.

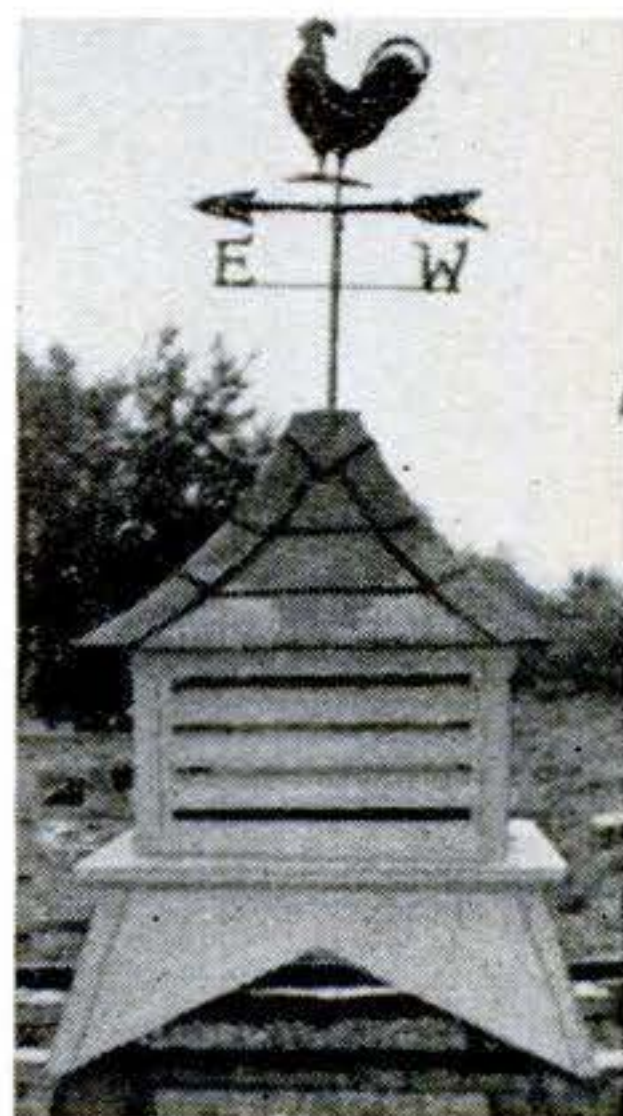

Smith works from house blueprints where possible, and often incorporates the homeowner's notions about decoration. Besides breaking up monotonous roof lines, the cupolas are useful to hide vent pipes or roof ventilators. Smith sometimes lines the purely decorative jobs with paneling to keep birds from nesting behind the louvers.

While proportions should suit the building, Smith says that for a small home or two-car garage, these dimensions are about right: 30" square at the base, 21" square at the louvered section, and 36" high, not including the weathervane.

Cleaning Stained Sinks

You can remove those stubborn rust stains from your enameled sink by treating them with acid. Vinegar or lemon juice sometimes does the trick, but dilute hydrochloric acid (muriatic acid) available from drugstores, is more effective.

Bleaching solutions, such as Javelle water or Clorox, will often remove light stains that do not yield to the abrasive household cleaners.



His Camera

Drama-packed industrial shots have made fast-moving, fast-shooting Robert Yarnall Richie a famous—and expensive—photographer.

By Ralph Steiner

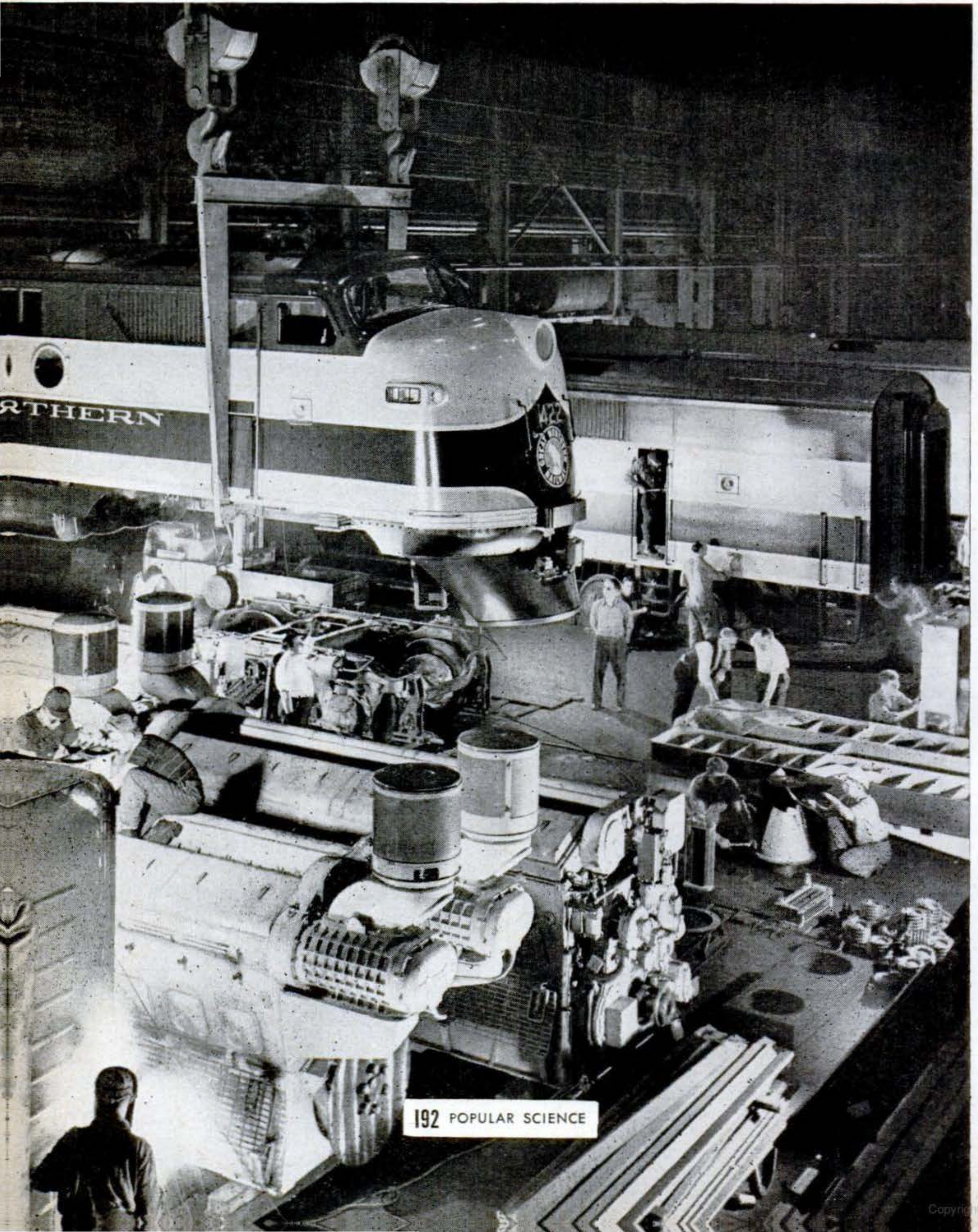

Earns Over \$500 a Day

IF YOU were president of a 10-million-dollar corporation and you wanted some good photographs taken of your plant, the name of Robert Yarnall Richie would probably come most naturally to mind. It might cost you as little as \$500 a day or as much as \$1,500 to get him behind his camera for a few hours. Still, no frown would cross your brow at the thought of his charges: Richie and his pictures would be worth every cent they cost you.

In the first place, you'd balance against his generous fees the fact that he shoots two to three times as fast as most of his rivals.

RICHIE TURNED STAGE MANAGER to set up this picture in General Motors' locomotive shop. He talked the foreman into turning the locomotive around so its front would show. An arc welder was spotted in front solely for drama. He wasn't really working. The bright rails and parts in right foreground were placed there to help the composition.

You'd get more pictures for your money. Count two, he shoots so fast he doesn't hold up your production line. So if your firm happened to make Cadillacs, you'd end up with one or two more Cadillacs at 5:30 than you would with a slower photographer who gummed up production while shooting. Count three, Richie's preparation for making a photograph often far outweighs the time and effort he spends behind his camera. Recently he flew his private plane from Charleston, S. C., to Palm Beach, Fla., looking for just the right lighthouse as background for a picture of a new automobile—which he later shot in an hour.

Got Start During Depression

What makes Richie a magic-money photographer? Not any trick camera or lens; many a three-buck-a-shot photographer uses the same equipment. It's the quality and quantity of his thyroid juices. They jet-propel him. He hardly ever stops whooshing, from British Columbia to Texas to New York to Saudi Arabia. I tried for three

A COLD WINTER MORNING was picked as best time for railroad scene below. Early light highlighted steam, cold made it cottony.

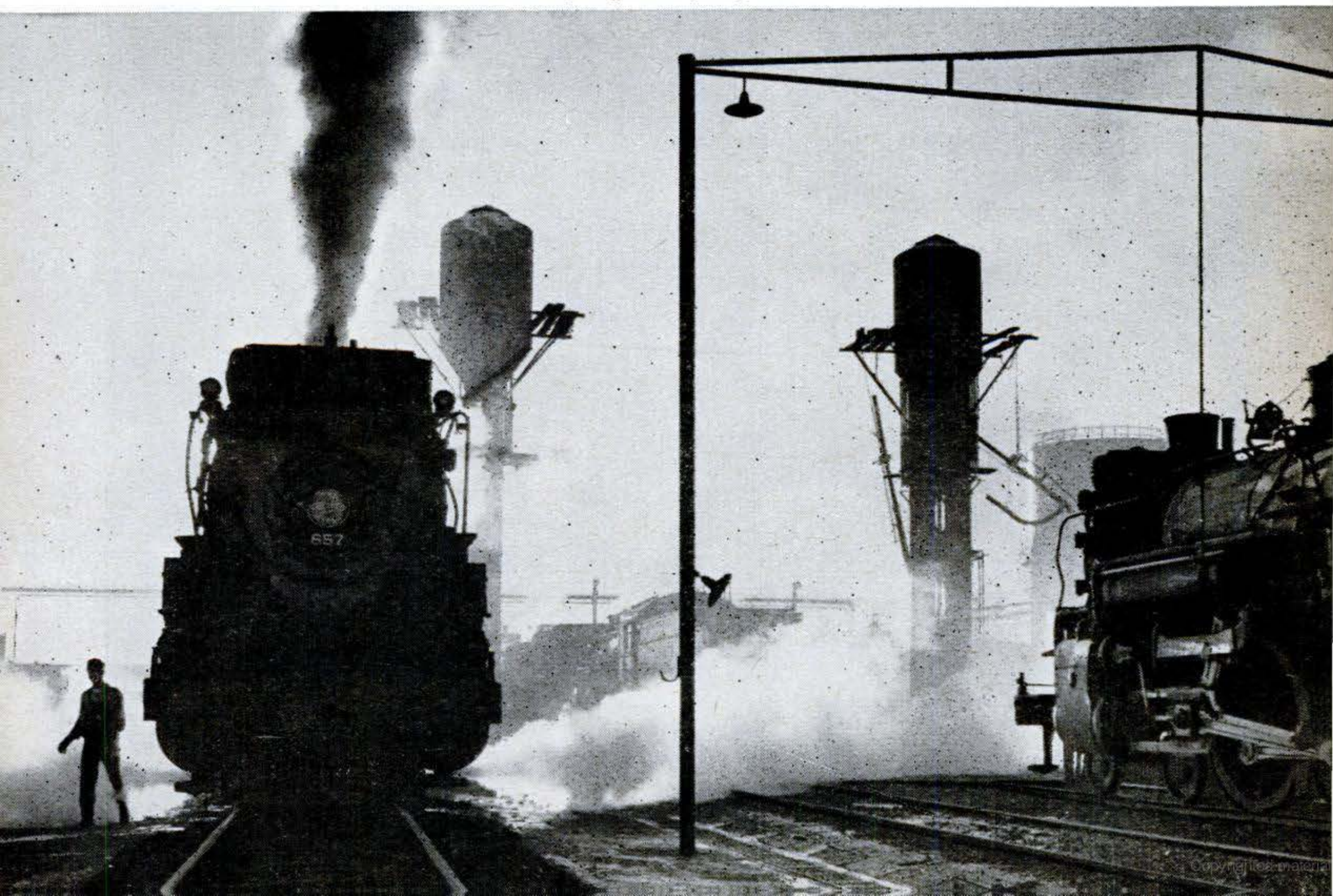

months to get him to light long enough to be interviewed for this story.

Richie's career began in the depression. Richie was 22, with a new pilot's license and no time to notice a little thing like a depression. A real-estate agent needed an air shot of an estate to interest a buyer, and Fairchild Aerial Surveys wanted more than he could afford, so the agent asked Richie to shoot it. Richie knew planes but not cameras. With more thyroid than know-how he zoomed into action and into a high-income-bracket career.

First Attempt Fails

He rented a plane for the next morning. Then off he went to Fairchild to rent a camera. Fairchild didn't rent cameras. Richie talked big about buying a camera if he liked it. Fairchild gladly lent him a camera. Richie knew nothing of camera weather, filters, camera angles, shutter speeds; but he

Advice from an Expert

Richie's advice to amateurs taking industrial pictures:

"If you haven't the equipment for indoor shooting, keep your eyes open early and late outdoors for unusual lighting that costs you nothing. Indoors, eliminate everything extraneous—simplify. Throw light only where you need it. Keep backgrounds neat or keep them dark. Shine all metal surfaces."

For pros: "I love my job; if you work for money only, you can't do a good job."

couldn't appear inexperienced in front of Fairchild by asking questions.

Next day the weather was dirty, but Richie figured if he could see to fly he could photograph. Dimly he saw the estate in the finder; dumbly but happily he snapped away. The gray, ghostly prints that came back from the laboratory would have been

A LOVE OF SPOTLIGHTING makes everything in a Richie picture zing out loud. In this case he turned two spots on technician, then directed five others to shoot into TV tubes and reflect into lens.

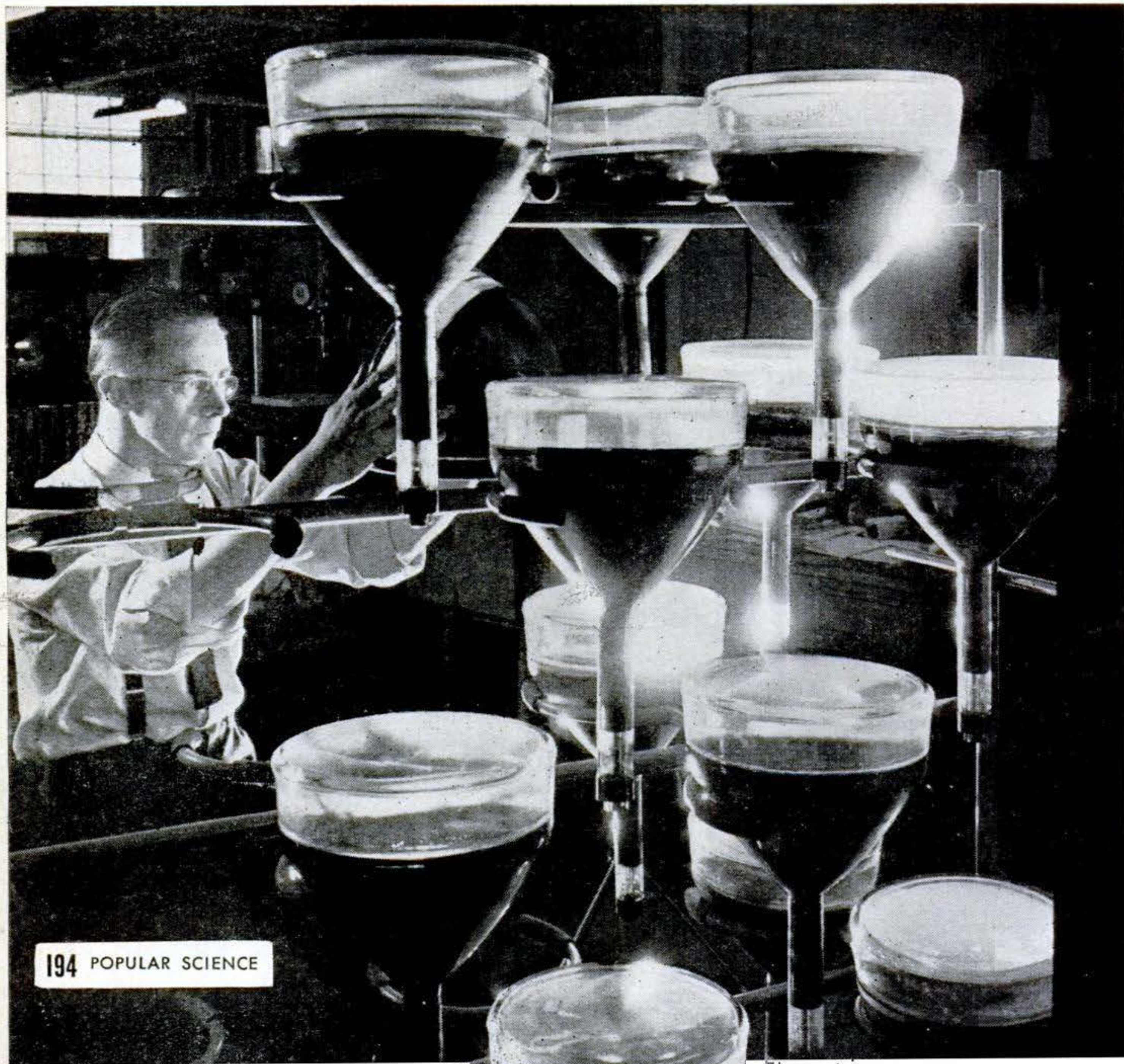

more help to a spiritualist than a realtor.

Somehow he wangled a camera from Fairchild once again. Smarter now, he waited for a clear day. And because rental of the plane for a second day would wipe out his profit, Richie shot not only the estate he'd fogged before but several others and a private school—"on spec." He sold every picture, made a profit and was deep in the photographic business.

Pictures Sell Clothes

He showed Rogers Peet, the clothiers, his shots of the private school and sold them on the idea of taking others for a back-to-school window display. Then they wanted a series shot from the ground: football, yacht racing, golf tournaments, trotting races. Richie developed the jitters because his technique was below zero.

Walking the streets of New York at

[\[Continued on page 228\]](#)

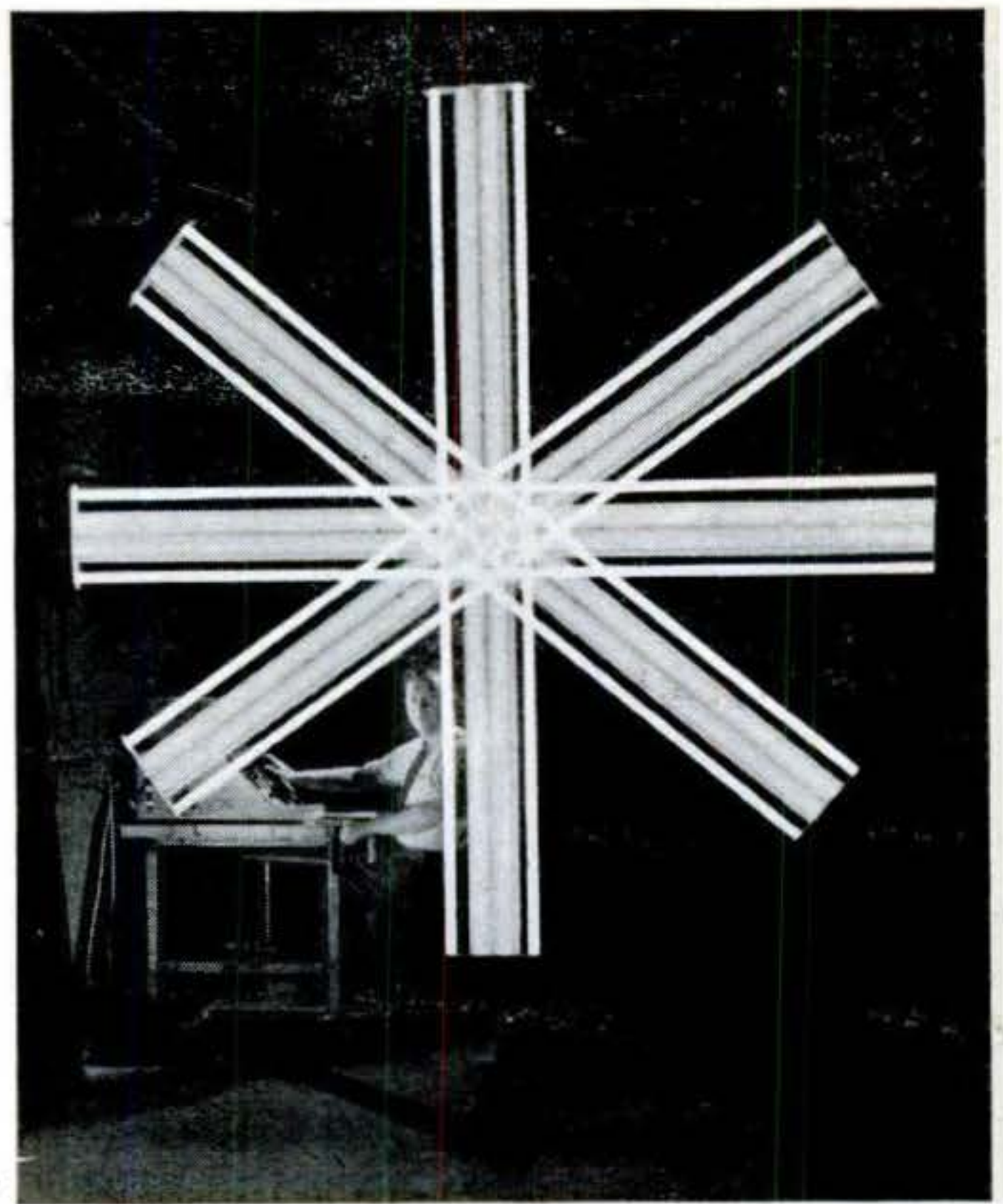

DULL PHOTOS ARE OUT, where Richie is concerned. His assignment here was to shoot a technician watching a meter that measures light given out by a fluorescent tube. First he photographed technician and tube. Then, discovering the tube could be inclined at any angle, he shot the tube three times more in different positions on the same film.

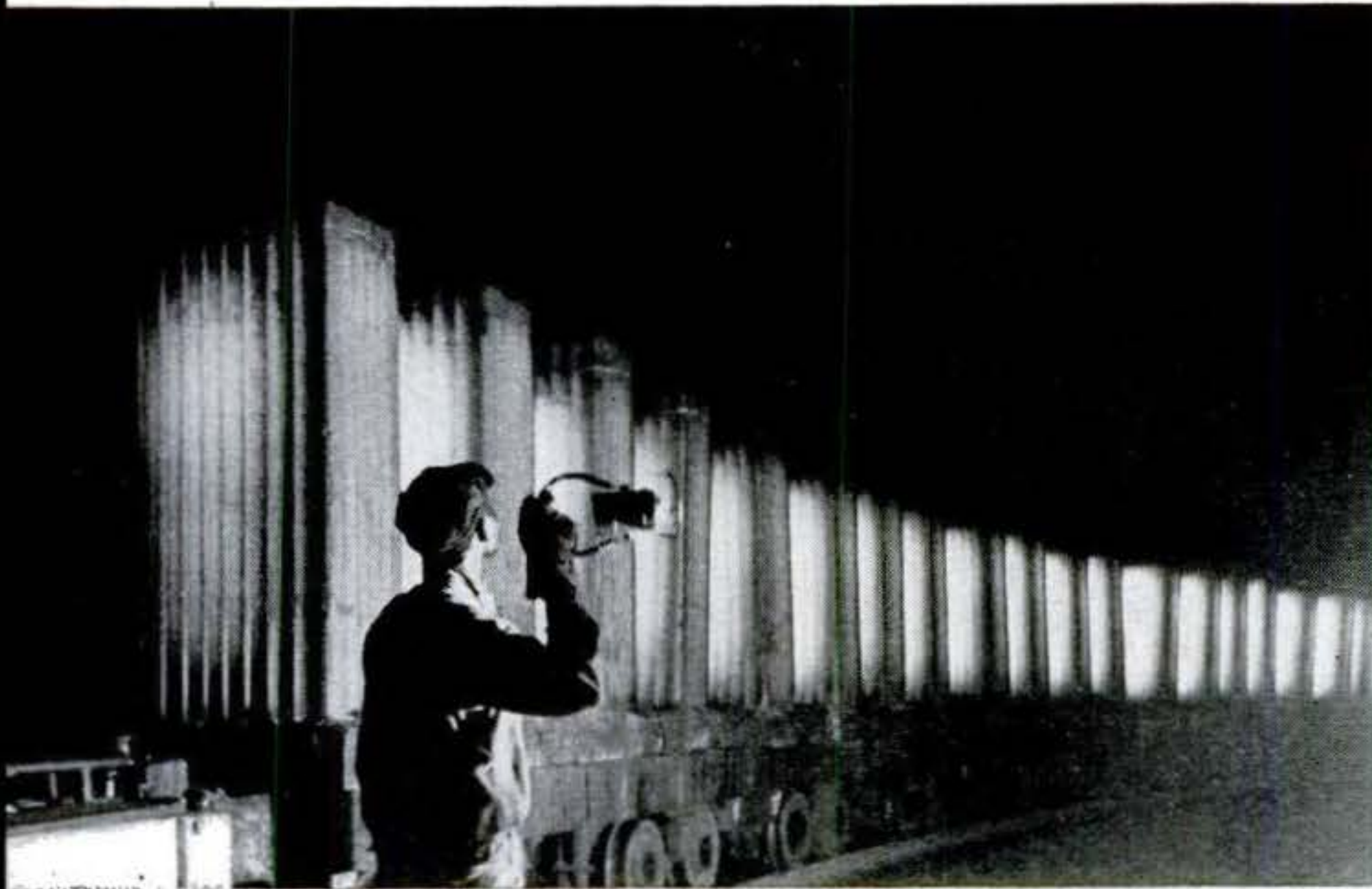

DRAMATIC LIGHTING of this night shot of a trainload of red-hot ingots going to the soaking pits was easy once Richie had gotten the idea. A flash bulb illuminated the man, a one-second exposure recorded light from ingots.

A SUCCESSFUL AFTERTHOUGHT.

Winding up a day's shooting in the Texas oil fields, Richie got the idea for this picture after his assistants had gone off with his lighting equipment. Undaunted, he turned the headlamps of two cars on the truck and asked the driver to turn his spotlight into the cab and shine it on himself. The driver held still and cut the truck headlamps halfway through a six-second exposure. The client hadn't asked for this shot, but used it more than any ordered.



How to Use Patterns with Power Tools

PATTERN SAWING uses a template tacked on the work. The template slides against the guide, leaving a piece identical with the template.

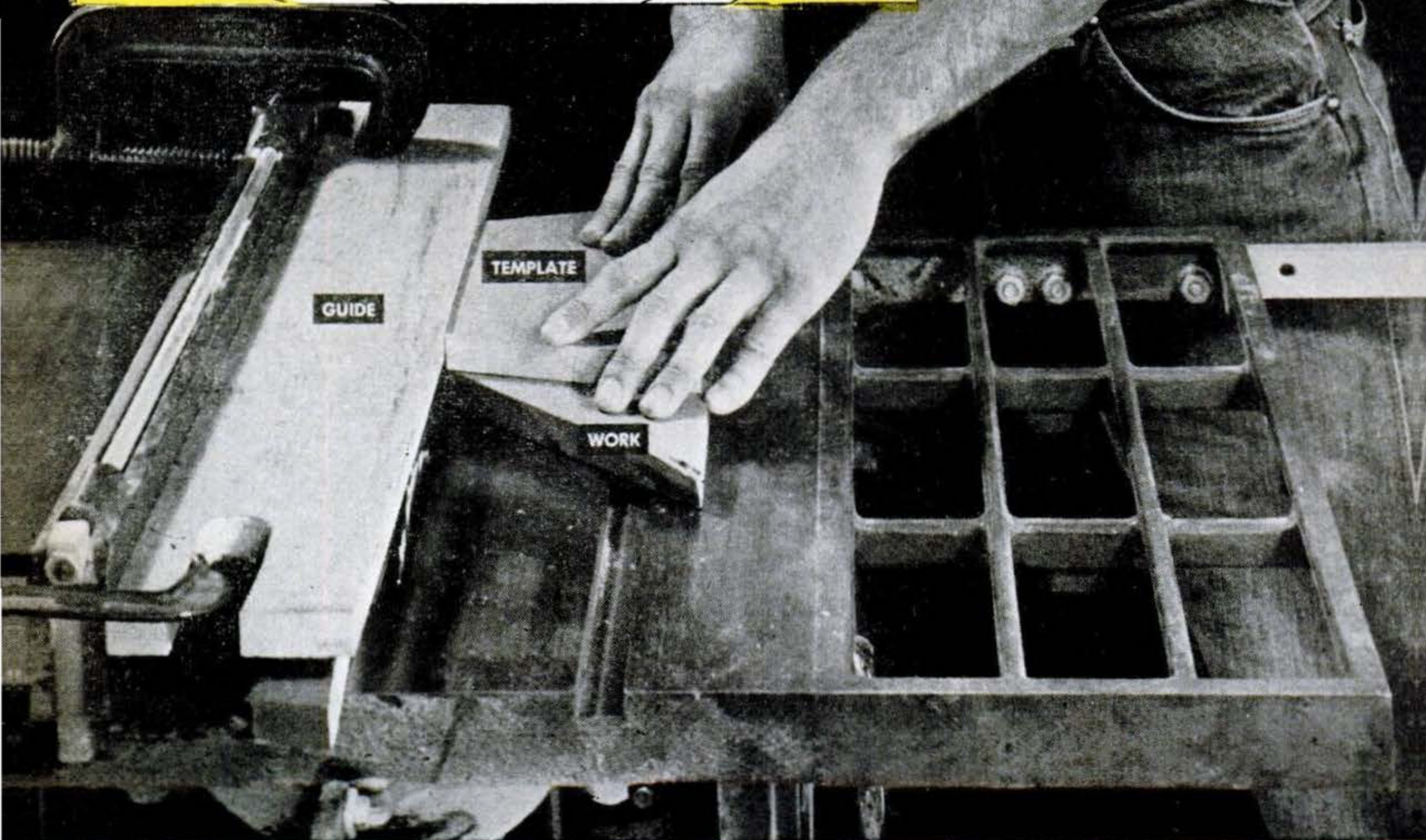

Jigs and patterns speed repeat shop work. They also let you turn out jobs that can't be done in any other way.

By Edwin M. Love

"AT IT again, I see."

Chet Thompson switched off the saw and looked up at his visitor. "Hi, Sid. Yes, I'm at it again."

Sid Howell picked up a small board with sloping ends. "How many do you have to make?"

"Never mind the 'you' business," Chet told him with a grin. "You're in this, too."

Chet Thompson was a sound craftsman. His wife was president of the Ladies Auxiliary. For those two reasons he had been elected to turn out souvenirs for the Auxiliary's state convention. The souvenirs were shaped pieces of $\frac{3}{4}$ " stock. After Chet and Sid turned out the blanks, the ladies would burn their organization's motto on them with electric burning irons.

Just Bang 'Em Out

"I know I'm in it," Sid chuckled. "My wife just gave me the word. But you'll have to brief me. I'm still in the ox-cart era with my shop."

Chet laughed. "Nothin' to it when you've set up a jig. Just bang 'em out."

Sid pointed at a notched strip of wood that was clamped to the fence of the table saw. "Is that the jig?"

"Part of it. That's the guide that the template slides against." The guide was clamped to the fence about an inch above the table to give clearance for the $\frac{3}{4}$ " stock to slide under it.

"Go ahead and make one," Sid said.

Patterns Can Be Fancy, Too

Chet picked up the template and tacked it down on a piece of $\frac{3}{4}$ " stock. He snapped the switch and made four quick passes, sliding the edges of the template against the guide. The blade lopped off the projecting edges of the work, leaving a trimmed piece identical with the pattern. Chet pried it off and handed it to Sid.

"There's a souvenir," he said.

"I can see now how we can turn them out so fast," Sid said. "That pattern stunt is all right. But suppose the women wanted some fancy work—and I'm surprised they don't—along one edge?"

"An irregular curve, for instance?"

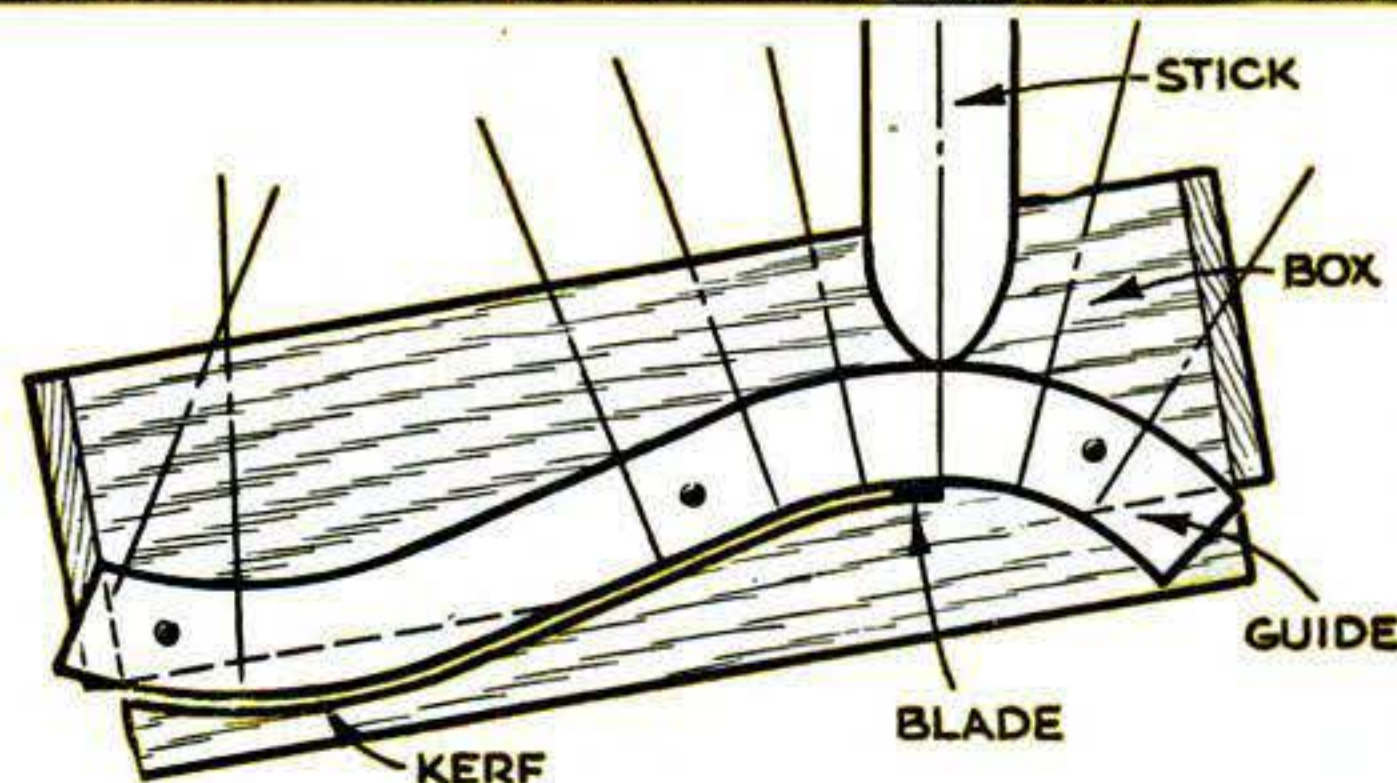
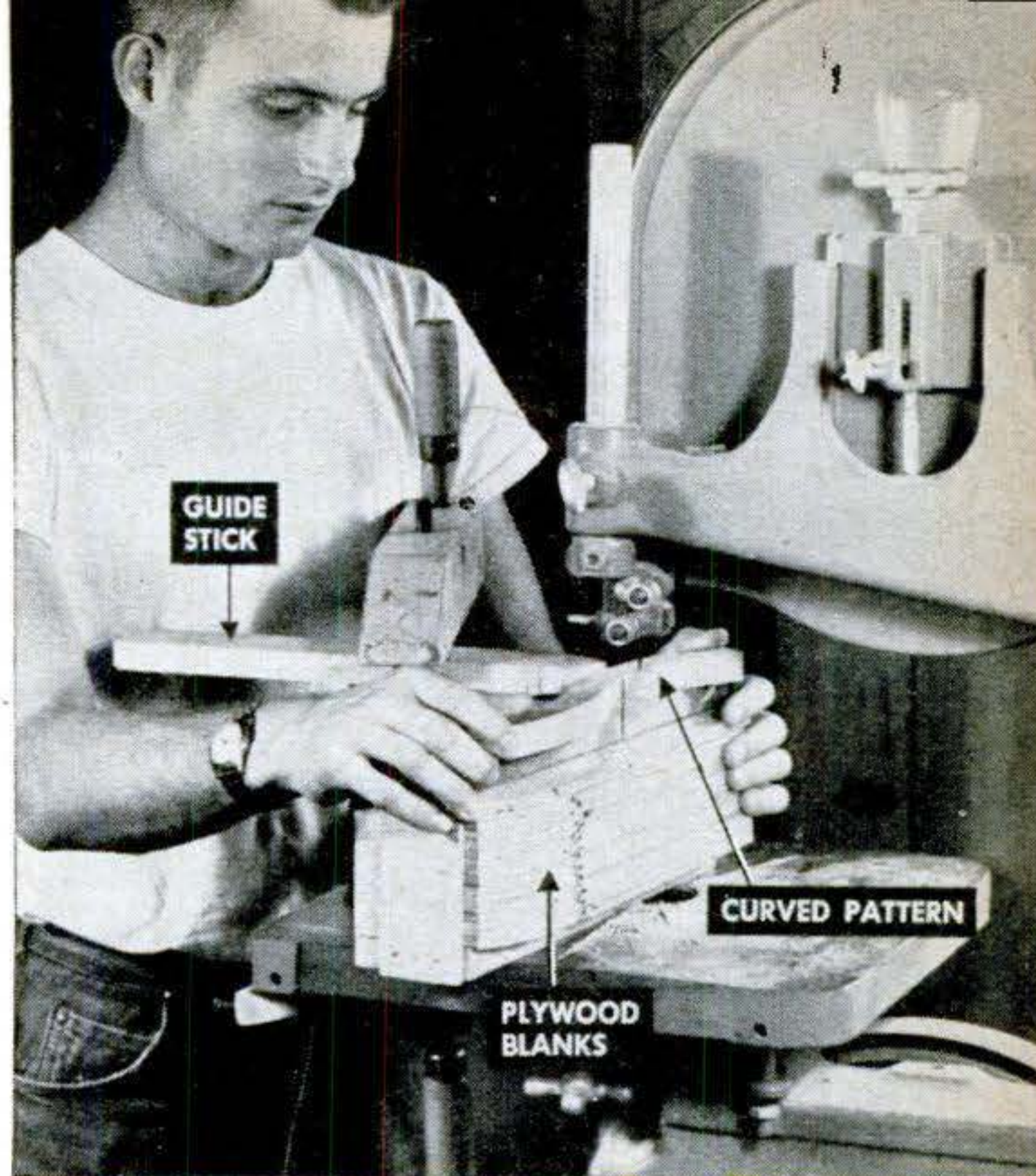

CUTTING A STACK on a bandsaw. The curved pattern rides against the bluntly pointed guide stick, causing the bandsaw blade to cut the same curve in the stack of plywood blanks.

"Yeah," Sid said. "Just suppose, but let's not suggest it."

"Take a look at this," Chet said. He pulled a dusty jig from a shelf under his workbench. "This is a mass-production gimmick I made when I was thinking about going into war work."

It was a box, open on one side, that held a stack of plywood blanks. A guide bar that had been bandsawed to the curve that was wanted was nailed on top of the box.

Cutting a Stack at a Time

"How does it work?" Sid wanted to know.

"Like this." Chet blocked up a bluntly pointed stick so the point bore against the curved guide bar. Then he clamped block and stick to the bandsaw table. "The point of the stick has to be opposite the teeth," Chet explained.

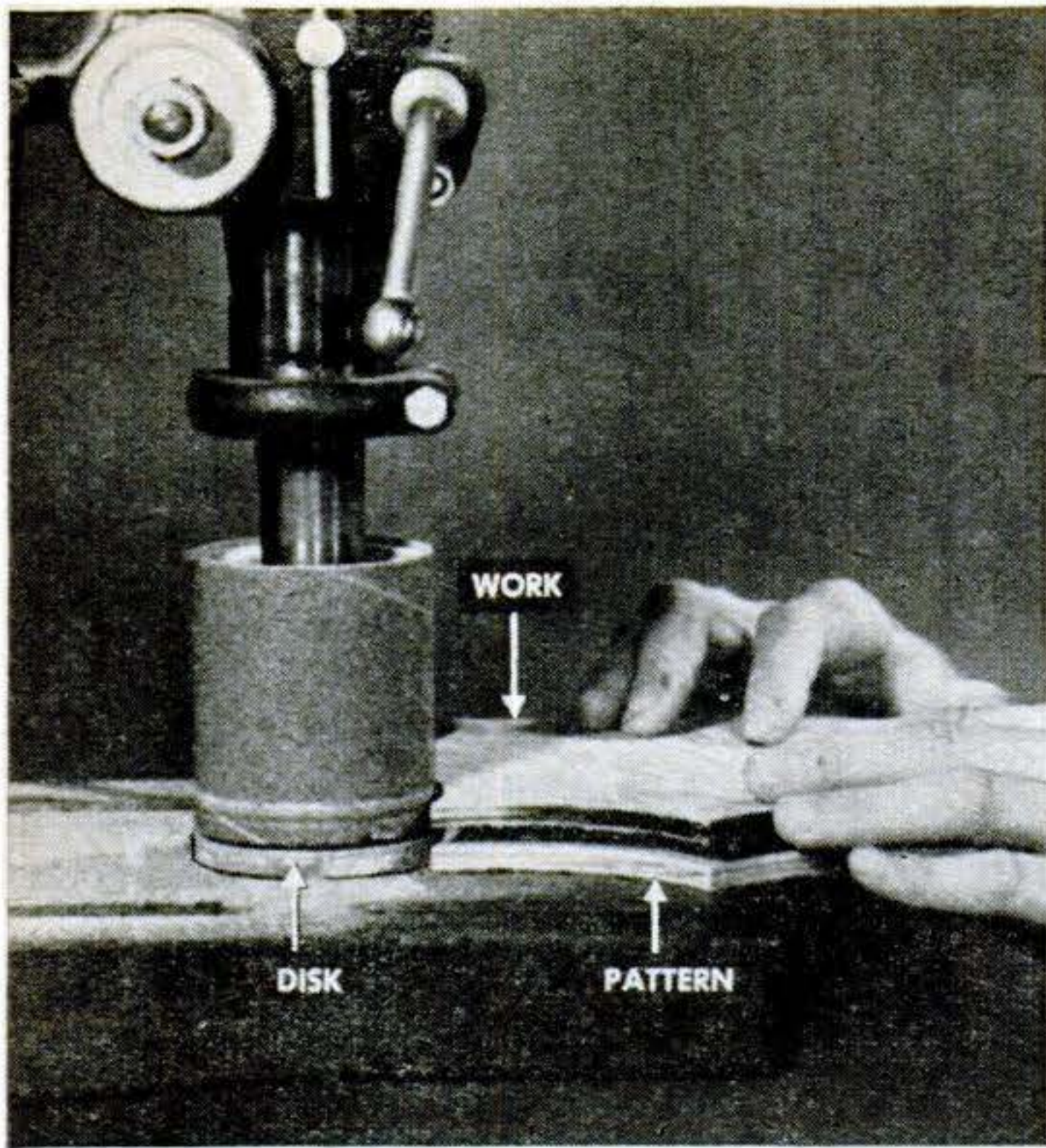

SANDING ON A DRILL PRESS. Wood disk, same size as sanding drum, is bolted to table. Pattern rides against this to guide work against drum. Shim work and pattern slightly apart.

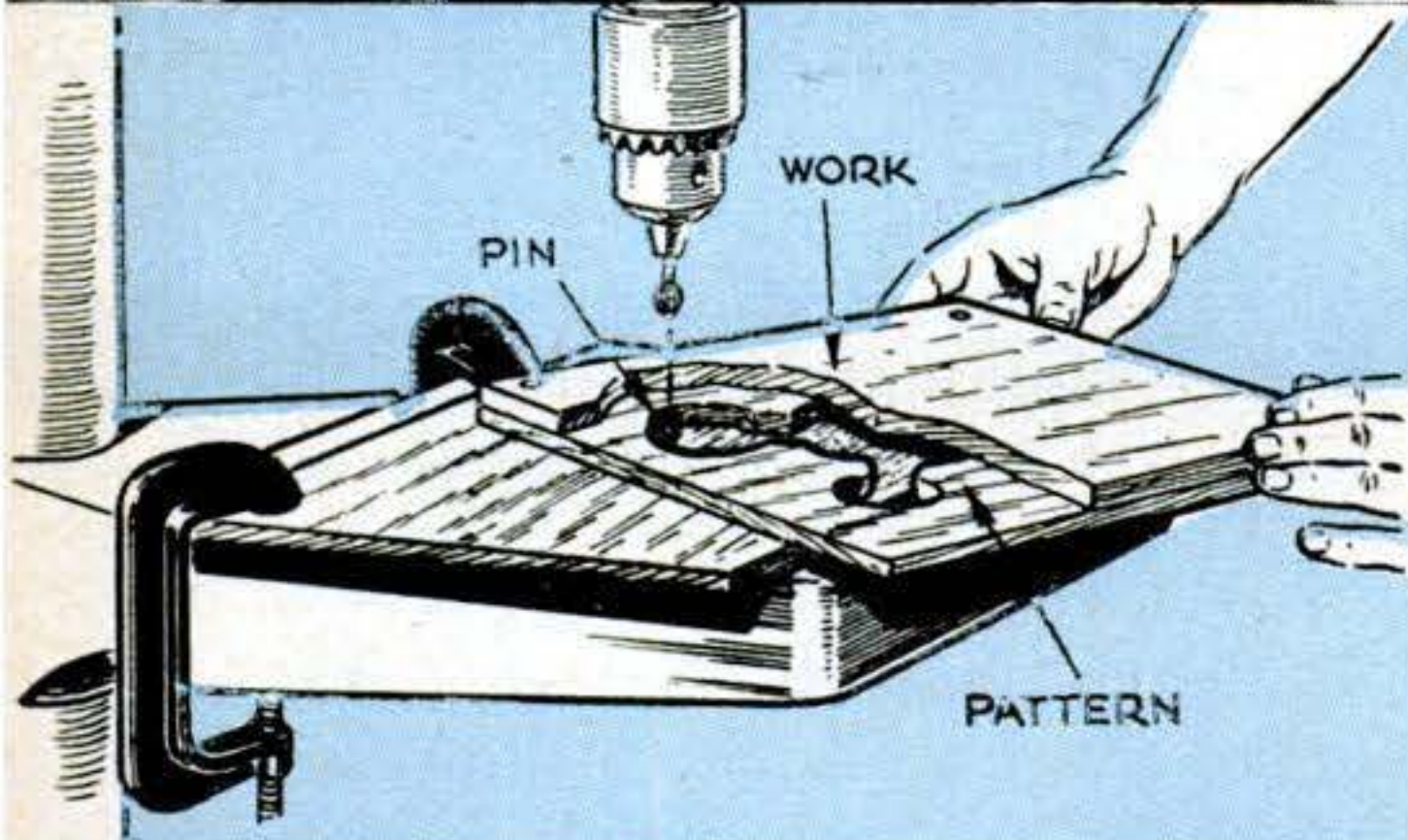
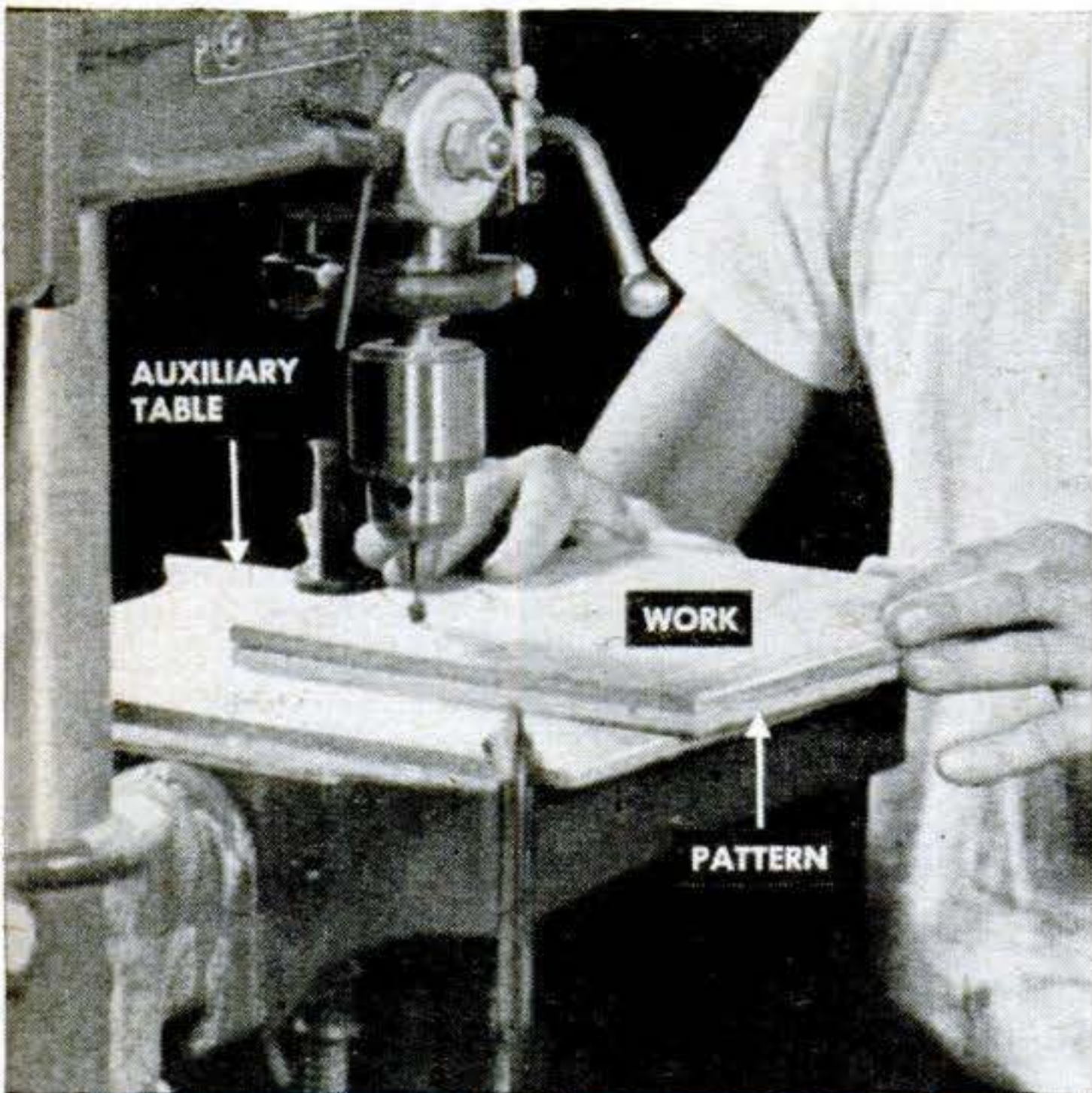

PATTERN ROUTING on a drill press. A pin in the auxiliary table directly under the router bit follows the pattern and bit duplicates pattern in the work on top.

He switched on the saw and began to feed the plywood blanks into the blade, pressing the curved guide bar against the pointed stick.

"Cuts the whole stack in one pass," Sid commented.

"Right. Only thing is, you can't feed these as fast as you could a single thickness. And don't rock the jig on its base. It's a good idea to use as wide a blade as possible."

"Seems to me you could manage pattern sanding, too."

Intricate Sanding Made Easy

"That's right," Chet agreed. "The drill press is a natural. You can step it down to about 1,200 r.p.m.—a good speed for a 2½" drum—and there's plenty of vertical adjustment."

Chet stepped to his workbench and picked up a piece of plywood that had scalloped edges. A scalloped pattern, with a shim sandwiched between, was tacked to the work.

"Here's a job I was working on when the souvenirs interrupted," Chet explained. He walked to his drill press. "Notice this disk bolted to the table under the drum." He switched on the drill press.

"I get it," Sid said. "The pattern bears against the disk and guides the work against the sanding drum perfectly."

"While we're at the drill press," Chet said, "let's have a little fun with pattern routing." He clamped a plywood auxiliary table to the drill-press table and chucked a router bit.

"See this pin in the auxiliary table?" Chet pointed. "It's the same diameter as the bit and centered exactly under it." He tacked a plywood cut out to the underside of a square of plywood and placed the cut out over the pin. Then he lowered the bit and locked the quill.

Invisible "Finger" Follows Template

"If you ran the bit down through the work," Sid said, "it would cut out the entire inside like the pattern. Seems to me that would be just about the same as jig-sawing."

"It would. For pattern routing you just lower the bit to the depth you want. Then you slide the template counterclockwise with the template edge bearing against the pin. After you've routed the outline, clear out the inside waste."

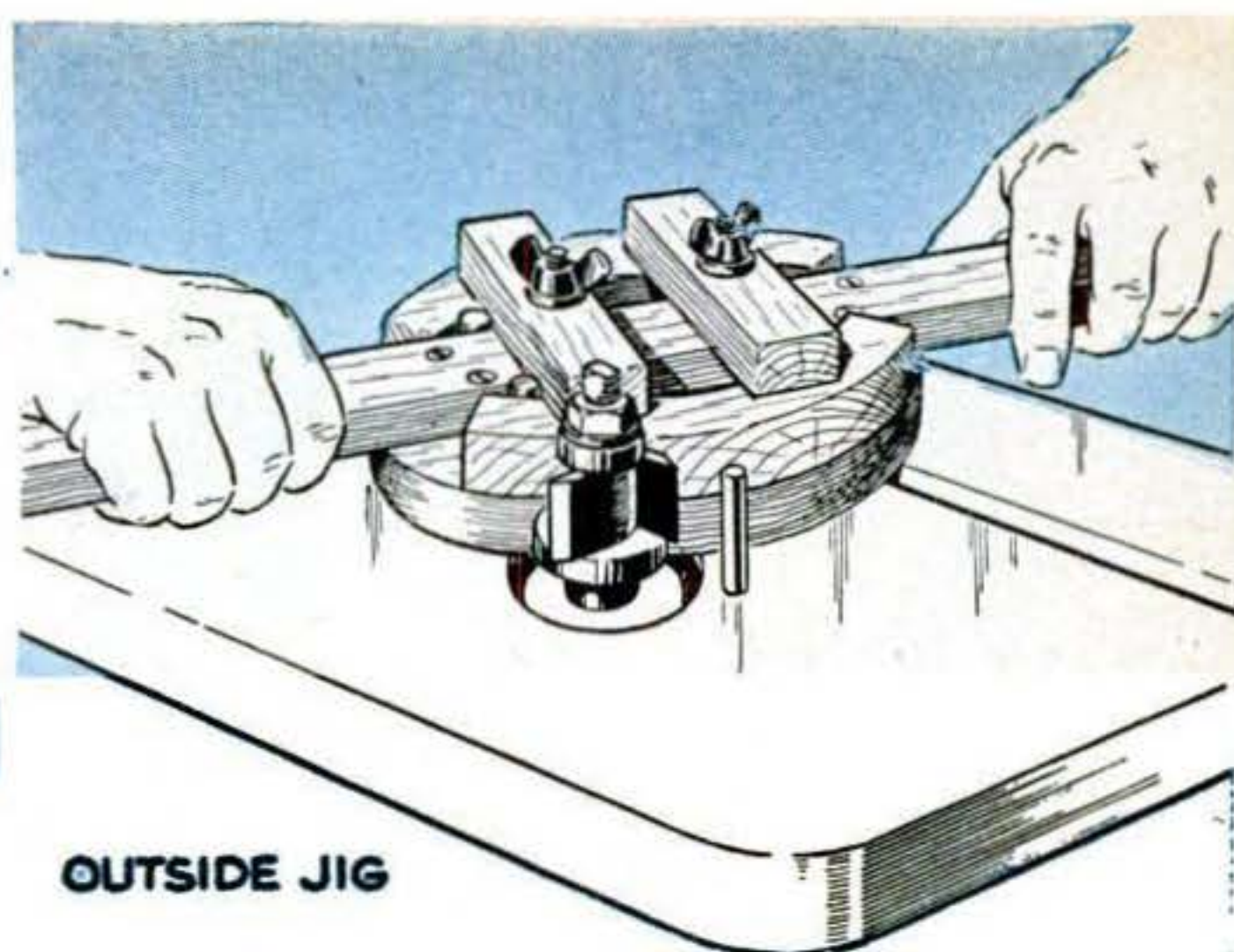
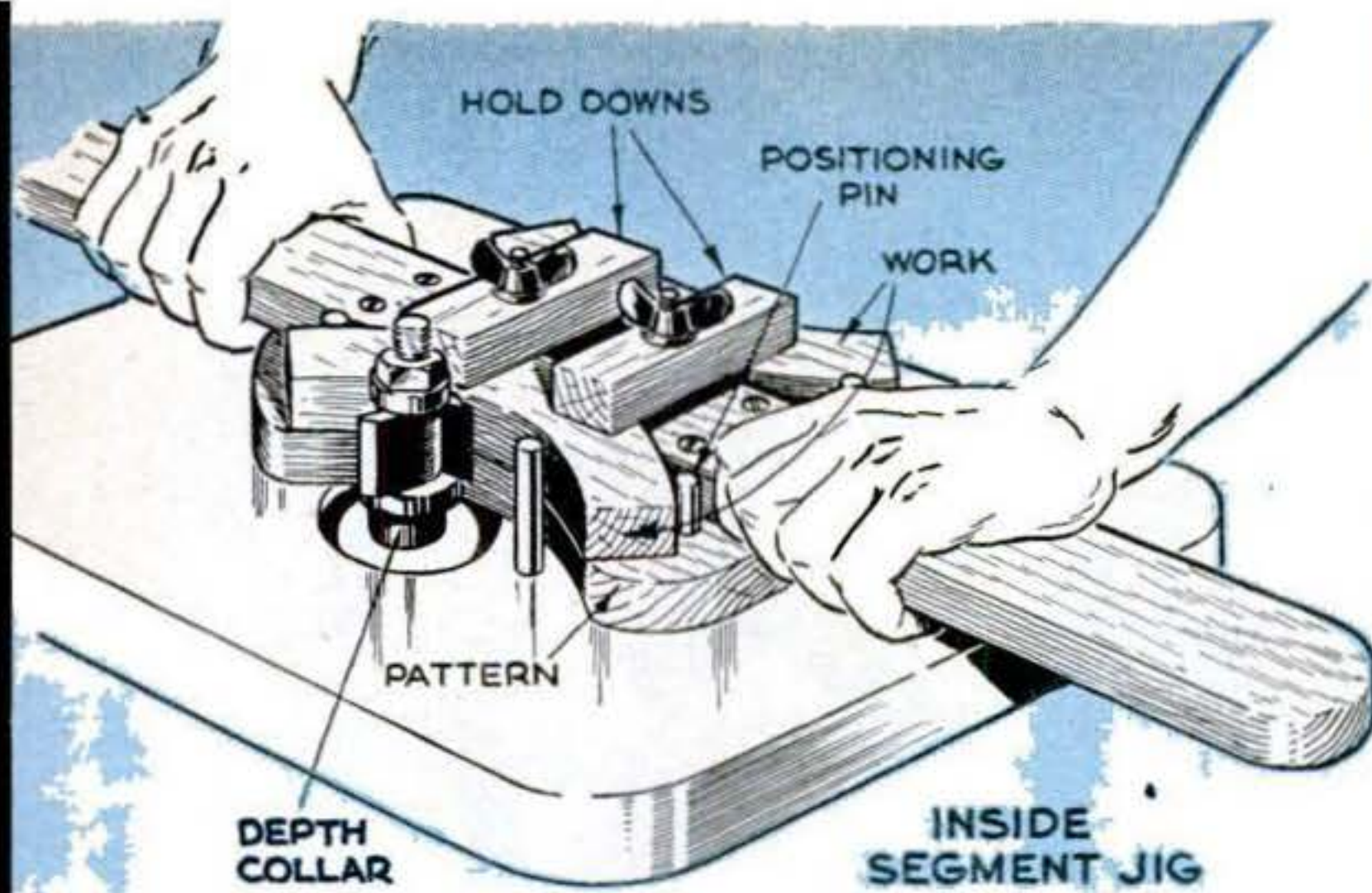

SHAPING CURVED PIECES. Jigs above, one for inside curves and one for outside, are faster than sanding for production runs. Pattern

rides collar, guiding work against cutter. Pins in pattern position work. Pieces should first be bandsawed to rough shape.

“What do you use for a pin? Dowel?”

“Yes. If I were going to do a lot of this work, I’d bore the auxiliary table for dowels shouldered down to match the various diameters of my router bits.”

“I see,” said Sid. “Then you could change pins just about as fast as you changed bits.”

“That’s the idea.”

Sid reached into the scrapbox and picked up a curved piece of wood. It was about 1” square and 6” long. It looked like an arc of a circle.

“Suppose,” Sid asked, “you wanted to smooth the inside and outside of this curve. What would you do? Sand them?”

“Yes, if I only had one piece like that to finish. If I had a lot to do, I’d build a combination template and holding jig and do them on the shaper.”

Jig Does Two Jobs in One

Chet picked up another piece of scrap and bandsawed a template. One side of it fitted the inside curve; the other the outside curve. “For a really long run,” he said, “I’d make two templates—one for the outside curve, the other for the inside.”

“But how would you clamp the work to those patterns?” Sid asked.

“A pair of cross yokes with bolts and wing nuts will do it,” Chet explained. “A pair of pins will position them. After you smooth one edge of each, interchange them. It might also be a good idea to screw handles to the pattern—for safety.”

Suddenly the cellar door opened. “Chet?” called a woman’s voice. “I’m back from the Auxiliary meeting.”

“How’d they like the sample souvenir?”

“We-ll. We were wondering. . . Couldn’t you make them just a wee bit fancier—put some nice scallops or something on them?”

Chet and Sid just stared.

“It shouldn’t be hard,” said the voice from the stairs. “You men are so clever with those tools. Besides, we made it easy for you.”

“You did?” asked Chet.

“Of course, dear. I overheard you tell how you use patterns to cut out the wood. Well, Madge had some wrapping paper, and. . .”

“You didn’t!” groaned Chet.

“Yes, dear, wasn’t that nice? We cut you out the loveliest paper patterns. Now all you have to do is go ahead and saw.” **END**

“Clothespin” Clips TV Antenna

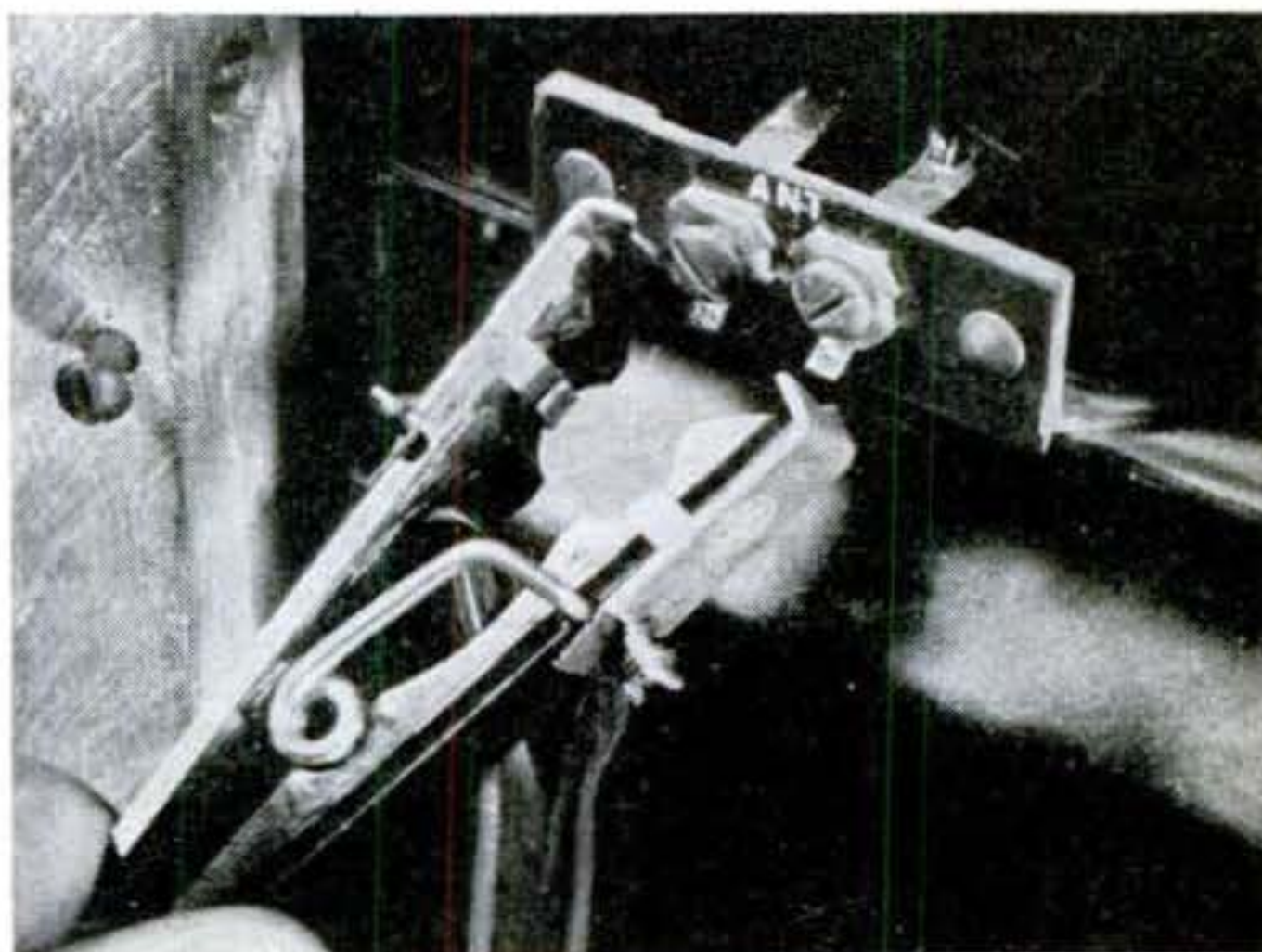

LOOKING like an ordinary spring-type clothespin, this plastic connector has metal tips that quickly clip to TV antenna terminals. The “Tenna-Clip” is made by Industrial Television, Clifton, N. J., for showrooms and service shops where one lead-in is moved from set to set.



Dressing Restores Car Top

APPLIED with a roller, a new convertible-top dressing gives an improved appearance to the fabric and restores its original water-repellency. Available in clear, tan or black, the dressing has a plastic resinous base that penetrates the fibers. A fungicide is included to retard mildew and dry rot. Champion Textile Finishing Co., Chicago, is the maker. Dressing kit includes a roller and pan.

My Most Ingenious Solution

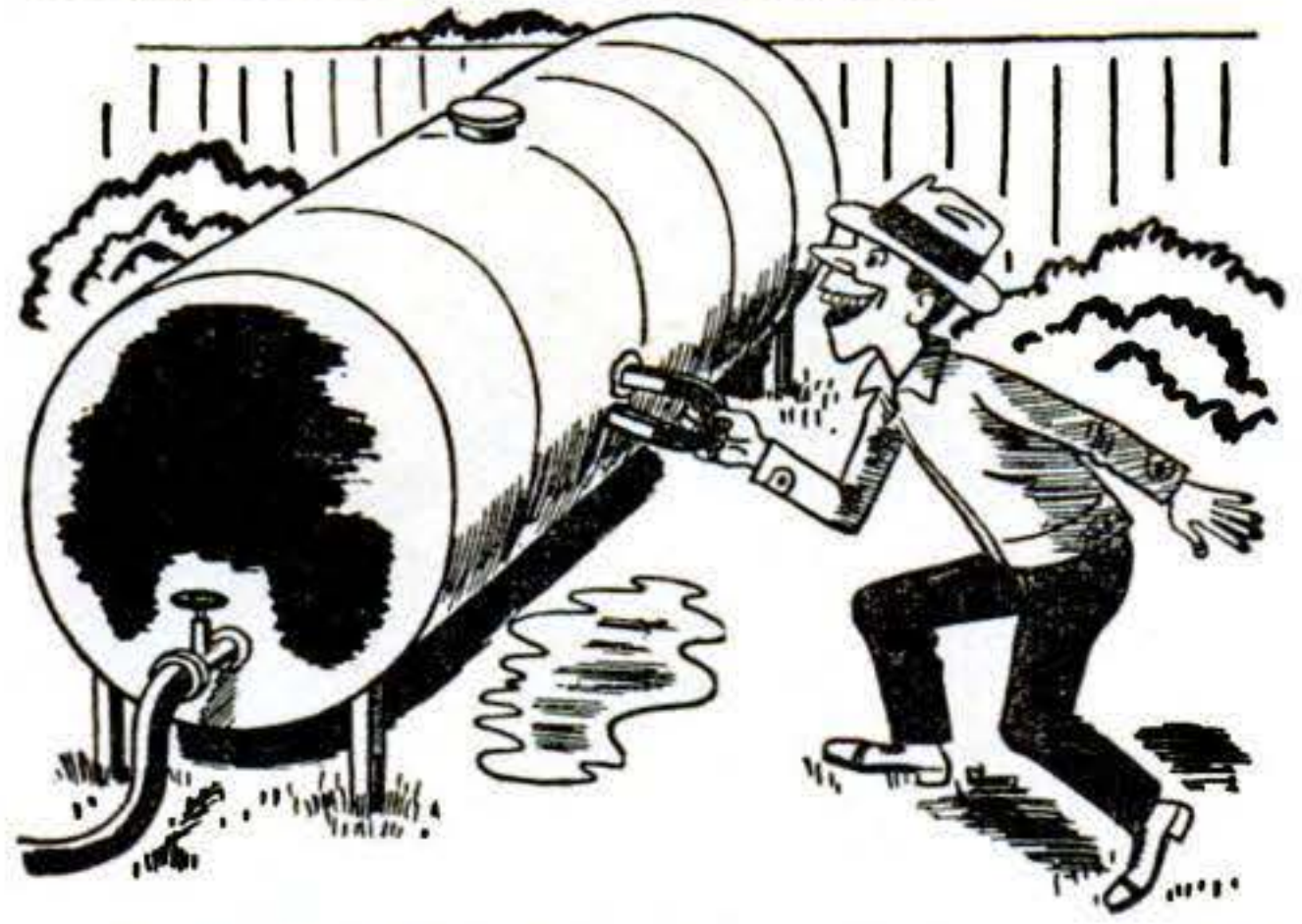

A 200-gallon oil drum sprang a small leak. When I saw my liquid assets dripping away, I knew something had to be done fast. I also knew what to do.

I hustled to my workshop and scouted up a strong horseshoe magnet and a thin slice of neoprene. I put the neoprene over the hole and covered it with one pole of the magnet to hold it on.—James B. Giern, Romeo, Mich.

New Flash Gun Has Pistol Grip for Off-the-Camera Shots

A PISTOL grip improves your aim when you shoot flash pictures with this new flash gun. A thumb button on the rear of the grip triggers the gun if it is used with a shutter having built-in synchronization. An L-shaped lever depresses the button when a synchro switch is attached for shutters using a solenoid tripper.

Made by Eastman Kodak, the gun has

space inside for one or two miniature 22½-volt batteries and condensers. With two batteries, the gun will fire as many as seven extension lamps. Extension holders are also made with a pistol grip.

Exposure information for different types of bulbs is printed on the back of each reflector. A special bracket attaches the gun to the camera for easy carrying.

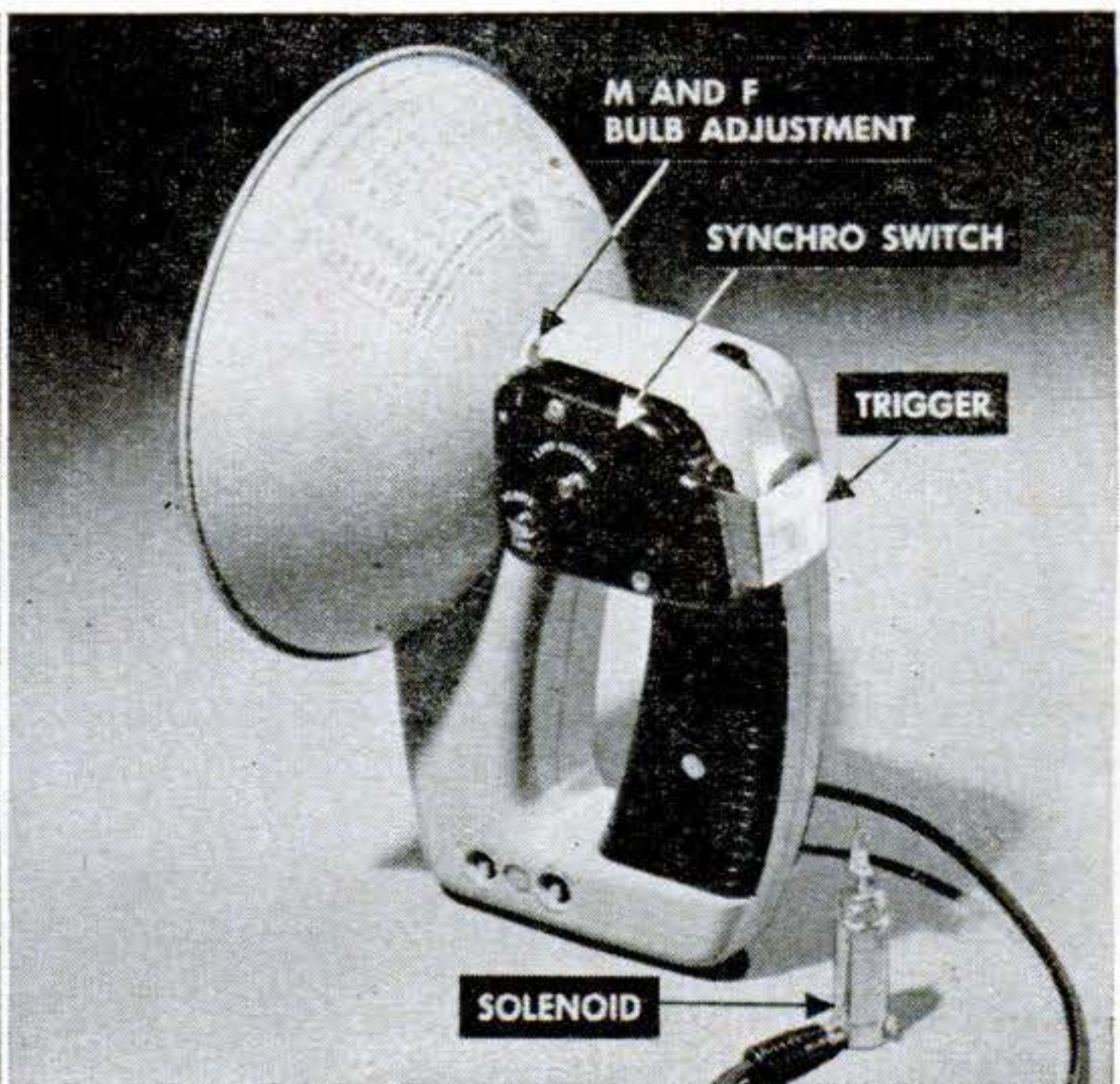
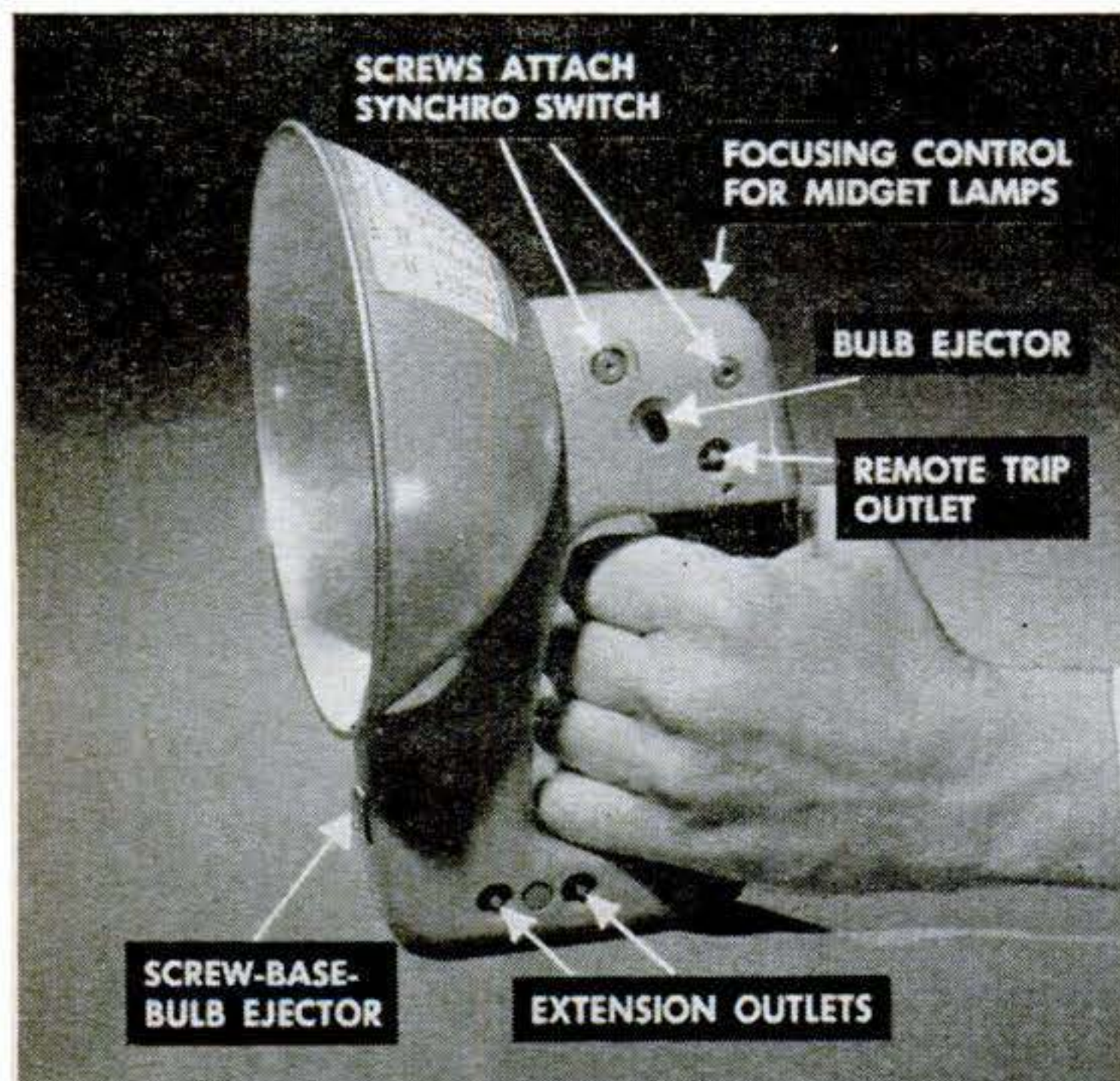

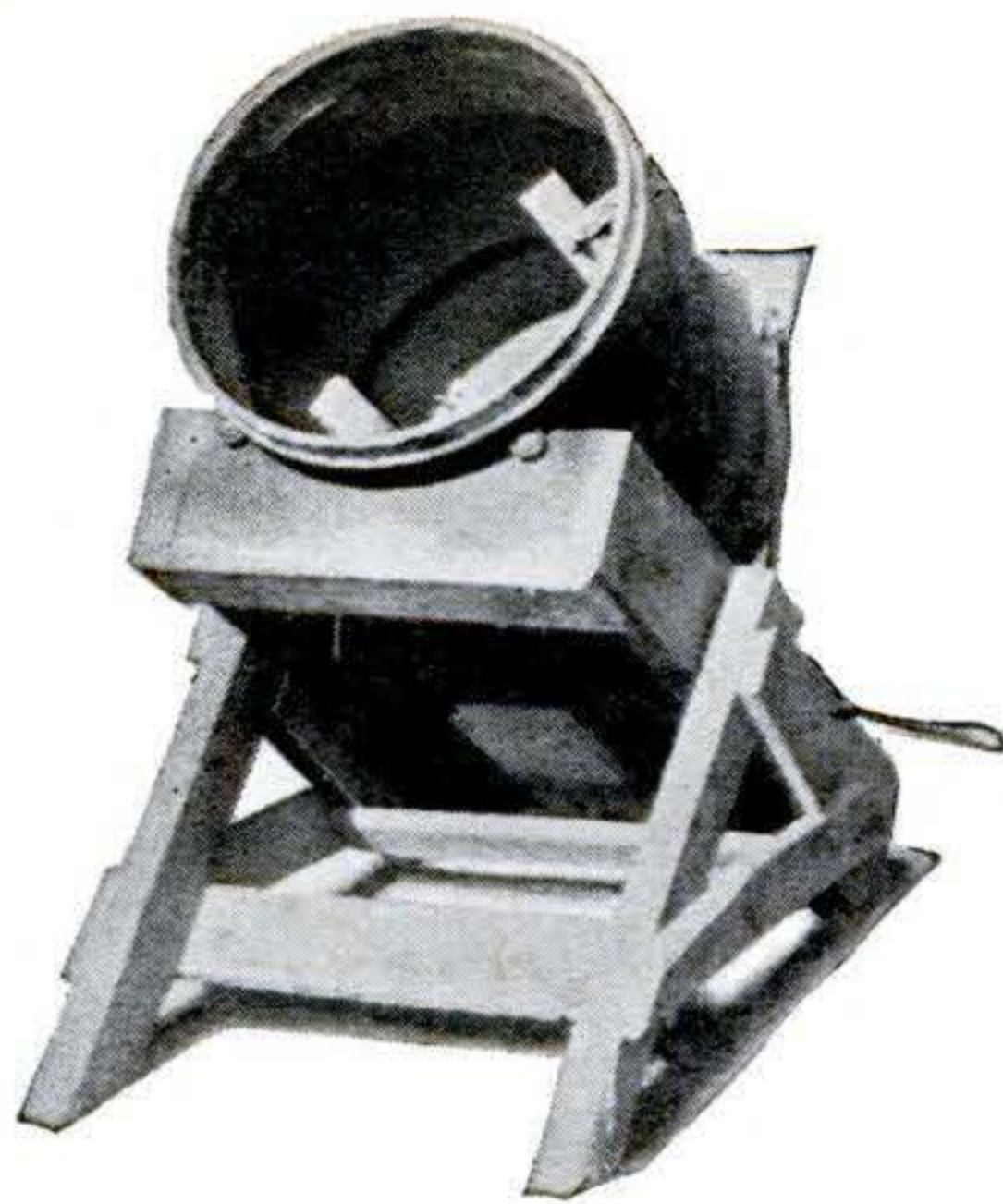

Washer Gears Drive Little Concrete Mixer

COMBINING the twin advantages of portability and low cost, this mixer is ideal for home concrete jobs.

The major parts are short lengths of lumber, a 30-gal. metal drum, a ½-hp. motor and a gear unit from an old washing-machine wringer.

The stand is a pair of A-shaped frames made of two-by-fours and braced with one-by-fours, as shown in the drawing. The cradle in which the drum revolves is built of two-by-sixes screwed together.

Two of the two-by-six cross-pieces are cut out to take the drum. Roller-skate wheels, on which the drum rides, are secured to these crosspieces.

Darryl Kraft of Chicago, who built this mixer, used a gear unit from an old Conlon washer. Any similar unit will serve. One end of the gear unit is centered on the bottom of the drum and bolted in place.

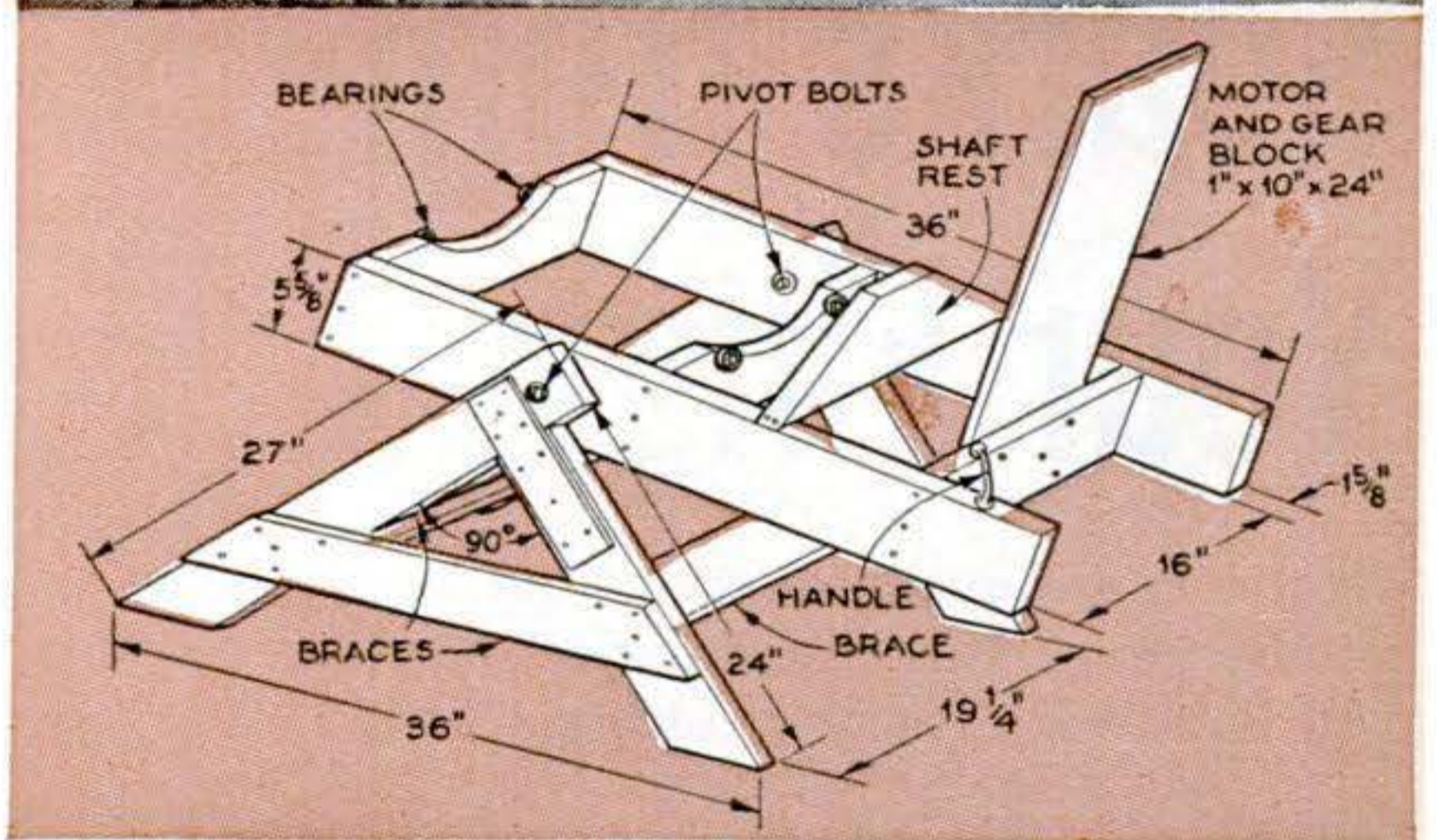
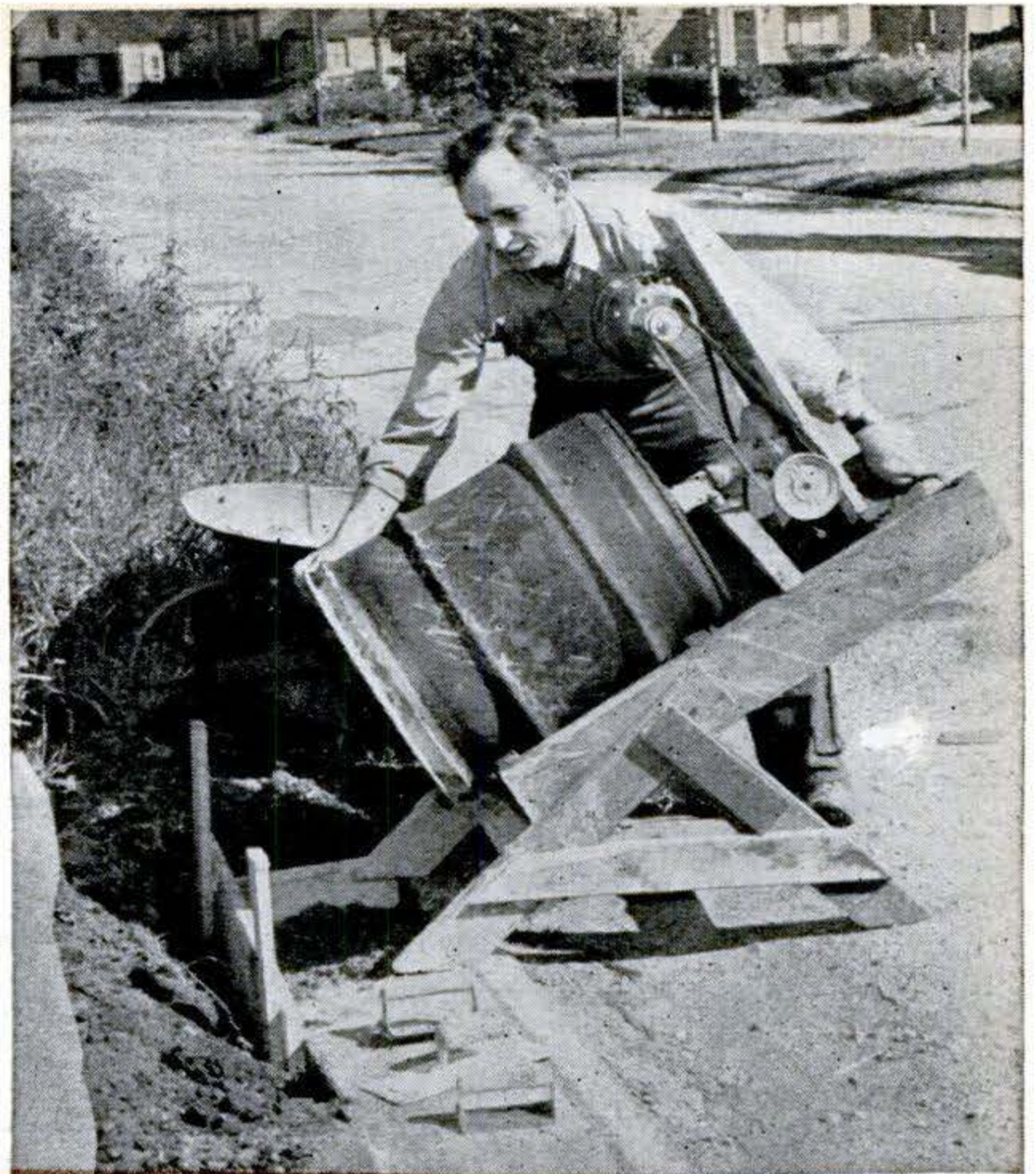

The other end of the unit is bolted to the cradle.

To help agitate the mix, an angle iron is bolted across the bottom of the drum and two pieces of one-by-two are bolted diagonally on opposite sides of the drum.—*Bert Goldrath, Chicago.*

Motor-Driven "Shovel" Throws Snow 20 Feet

CLEARING drives and walks is easy with this push-button snow shovel. Its rotor blades will throw snow up to 20', and its ½-hp. motor has a reversing switch that changes the direction of throw. The snow remover rides on semi-pneumatic tires, has a handle that adjusts for height, and is equipped with 100' of cord. It operates on 115 volts. The Electric Snow-Blo is made by Sensation Mower, Inc., Ralston, Neb.





STATIC IS A HAZARD in the presence of a flammable liquid or vapor. The sparks can cause a fire when you dip or rinse clothing in gasoline or volatile cleaning fluid. Sparks produced by combing hair have ignited shampoos.

You can demonstrate this danger. Have a friend stand on inverted glass jars to insulate him from the ground. Give him a metal spoon and rub the back of his jacket briskly with a vinyl-plastic phonograph record. Then have him hold the spoon near a few drops of carbon disulphide in a metal bottle cap supported on an upturned cake tin. A spark will jump to cap, firing the fluid. (*Caution: keep open bottle away from flame.*)

Sparks from Your Fingers

Static is annoying at this time of the year. But these experiments put it to work for an evening's fun.

By Kenneth M. Swezey

ANY way you look at it, static electricity is a nuisance. It causes unwelcome dust to hug your phonograph records. Its snapping spark makes you jump if you touch metal while riding on plastic seat covers. It brings crackles from your radio. And, worst of all, it can touch off a fire or explosion if conditions are right.

This is the favorite time of the year for static to play its pranks. In January, low indoor humidity leaves surfaces dry, and static charges build up. In June weather, high humidity spreads a film of conductive moisture, draining away the static as fast as it forms.



MOISTURE ELIMINATES STATIC. With a vinyl record and scraps of tissue paper you can prove it. Rub record with wool cloth and hold it near paper scraps. They will jump to record (left). Then remove paper and

blow your moist breath over surface of record (center). Now rub record with wool cloth again and try to pick up the paper. You'll find you can't (right). This time the static has drained away through your hand.

WHY TIRES MAKE STATIC. While you drive, tires and tubes are constantly flexing. This stretching and contracting of rubber charges it with static. One result may be crackles in your car radio. The mere making and breaking of contact between tires and road also build up a charge. An electroscope like this one will show how rubber produces static. After stretching a rubber band, draw it across the electroscope knob. The farther you draw it, the farther the tin-foil leaves will spread apart. Next discharge the stretched band by drawing it across a grounded pipe. Let band contract, and draw it again over knob. Leaves will come together. Contraction also charges band, but charge has opposite polarity.

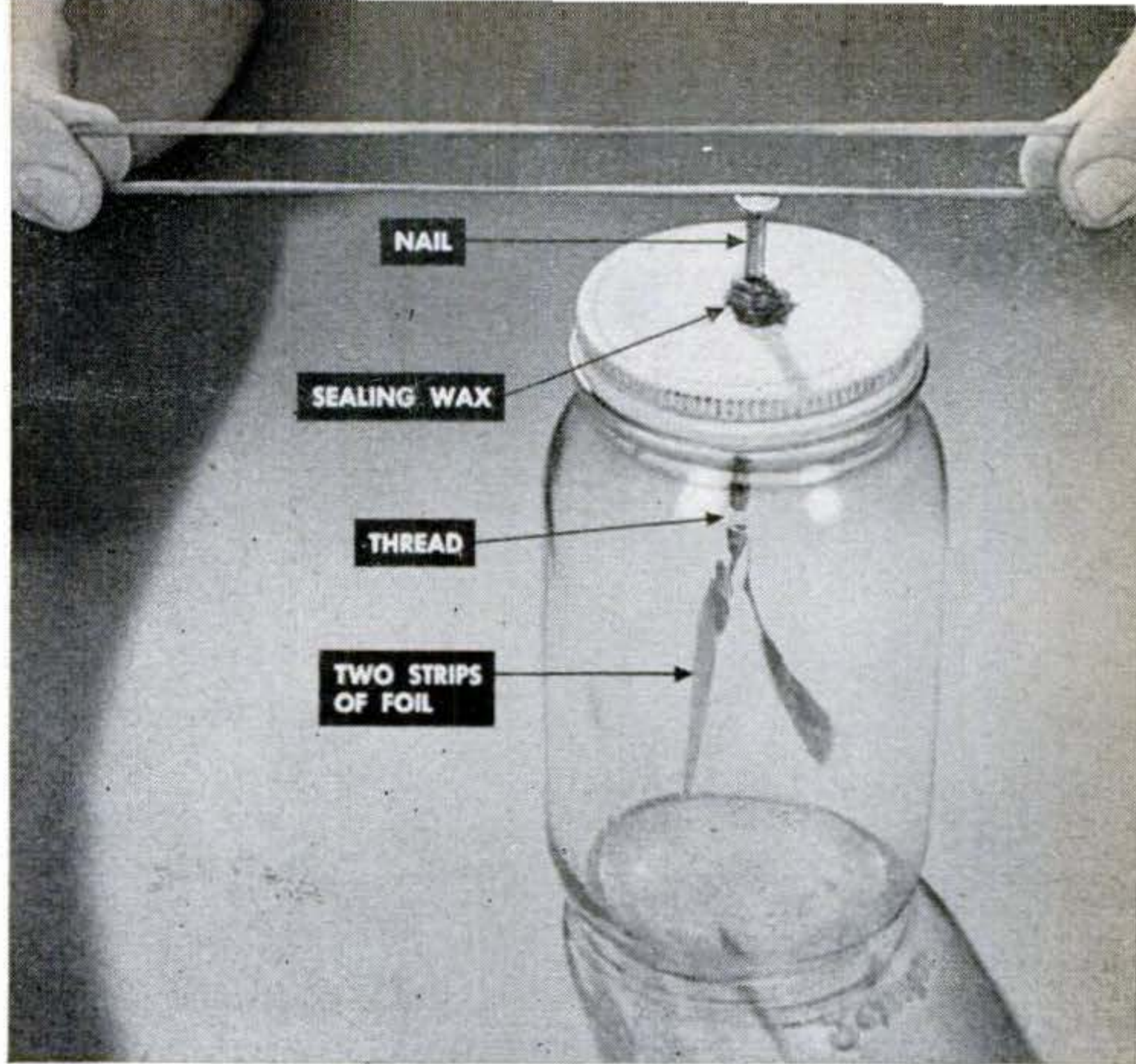

If you understand static, you'll have a better chance of forestalling its tricks. Here is a series of experiments to show you what it's up to.

What is static? It usually is the result of separating two substances that have been in close contact—a comb from your hair, a belt from a pulley. While the objects are in contact, free electrons pass from one to the other. After they are separated, the object that has lost electrons carries a positive electric charge, the other a negative charge.

If the object is a good conductor, the charge leaks off to the ground as fast as it forms. If the object is an insulator, the charge may attain an amazing value. When you comb your hair on a dry day, the potential behind the crackle may reach 10,000 volts. Your car may build up a 40,000-volt charge from rolling along a dry road.

Friction is one way of producing close contact. But actual friction is not needed to produce static. For instance, a thoroughly dry photograph is charged with static when you peel it off a ferrotype plate.

How to eliminate static. An antistatic powder is now in common use in automobile inner tubes. Made of a conductive material such as carbon black, it is blown into the tubes to help drain off the charge built up by flexing. Some inner tubes have an antistatic lining.

Because moisture drains off static, humidification is a common method of static elimination. Extra moisture may be supplied to

STATIC IN PRINTING PLANTS. You may have seen small gas jets near the paper where it leaves a press. These flames have the job of eliminating static from the paper.

The homemade electroscope will show how this works. Charge the electroscope by pulling a comb through your hair and touching it to the electroscope knob. If you now bring a candle near the knob, the leaves will come together. The static is discharged because chemical action in a flame produces ions, electrically charged molecules. Ions of opposite charge to the static neutralize it.





WHERE TO HIDE FROM LIGHTNING. The best spot is inside an enclosure made of conducting material—an auto or steel-frame building. Since lightning is basically just static grown up, you can demonstrate this with a kitchen pot and wire strainer.

Set the electroscope in the pan, run a comb through your hair to charge it, and

the air (from which it will condense) or applied directly to the surfaces.

Vinyl records, plastic seat covers and leather substitutes used for upholstery are subject to static because they repel water. Static-eliminating solutions to be wiped or sprayed on such materials generally consist of a water-attracting substance such as ethylene glycol or glycerine plus a trace of a conducting chemical, sometimes just common table salt.

To remove dust from vinyl-plastic records without electrifying them further by rubbing, some manufacturers suggest that you wipe them with a soft cloth that is just barely damp.

How to make an electroscope. For some of the accompanying experiments, you will need an electroscope. You can make this from a glass jar, its metal cap punched with a ½" hole, a large nail, thread, sealing wax and foil from a chewing-gum wrapper. The paper rubs off the foil easily after soaking in alcohol. The nail must be well insulated from the jar cap by the wax. An accompanying photo shows the assembly.

Any charged body brought near the knob (the nailhead) of your electroscope will cause the foil leaves to repel each other and fly apart. If you touch the body to the knob

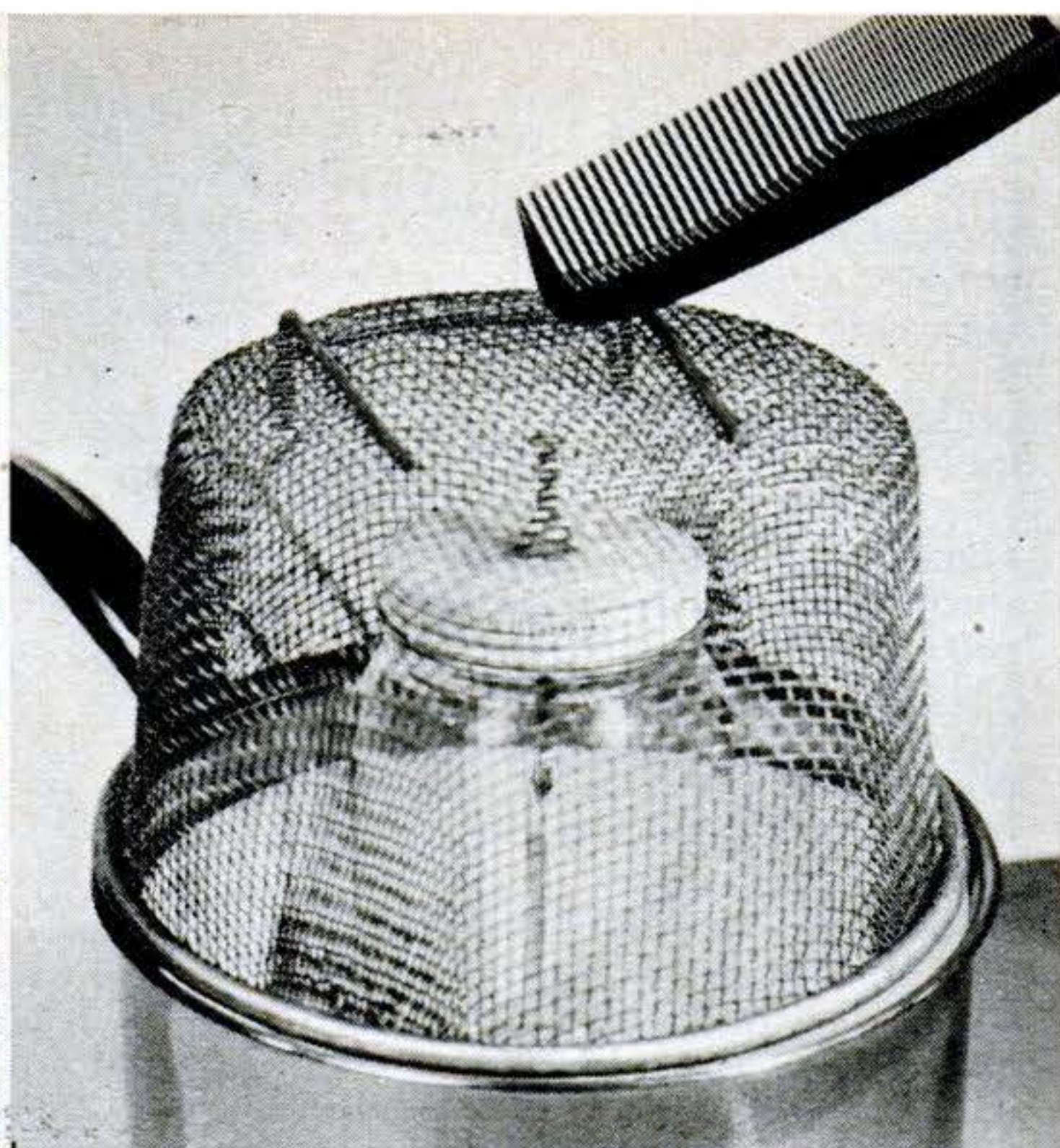

bring it near the knob. The foil leaves will separate, showing they are charged. Now discharge the leaves (by bringing a candle flame near them) and cover the electroscope with the strainer, being careful that it doesn't touch the knob. Bring charged comb near the knob. The electroscope will not be affected, for the strainer shields it.

and then remove it, some of the charge will remain on the leaves, holding them apart.

Next Month: Ken Swezey shows you how to make "X-ray" photos with a luminous watch.

Shoptalk:

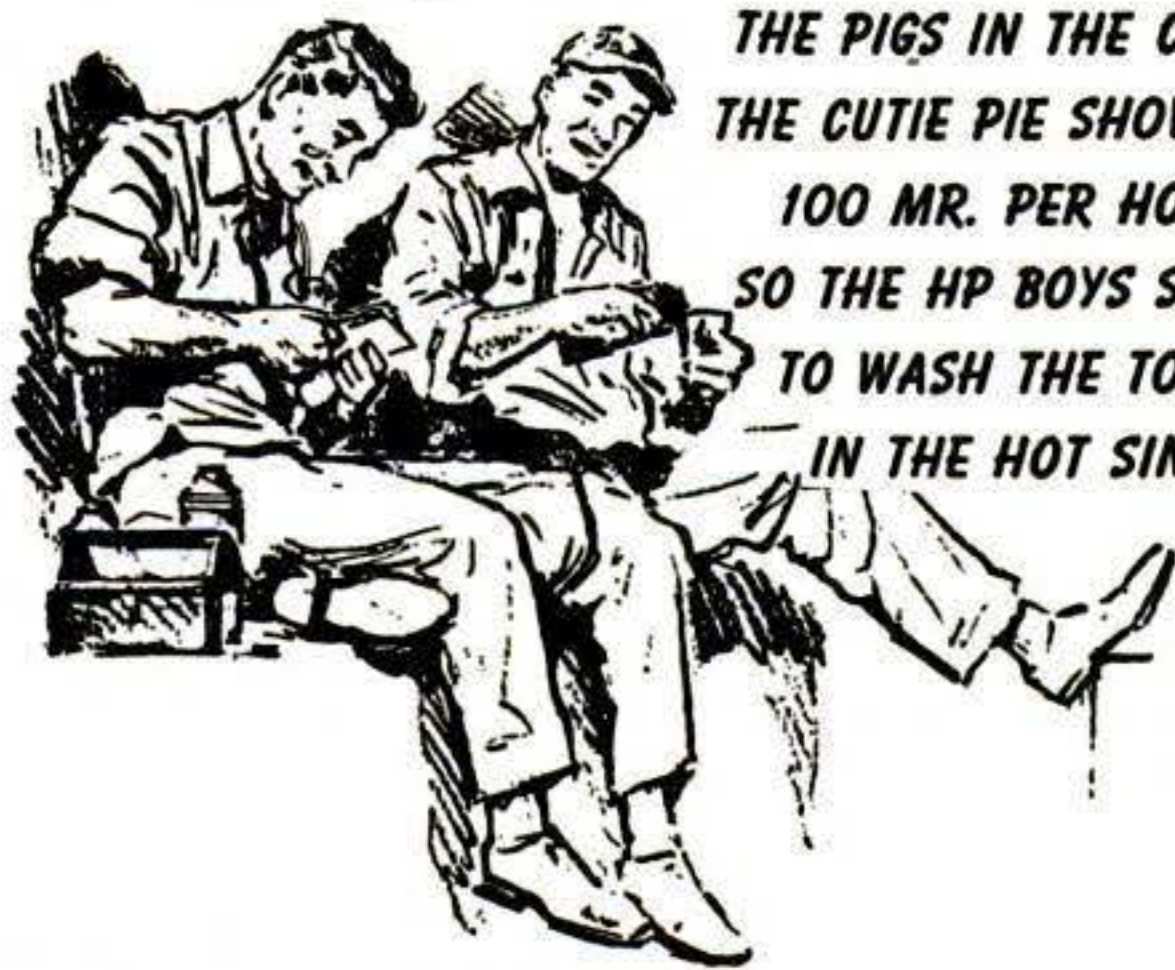

"AFTER WE PUT THE PIGS IN THE CAVE, THE CUTIE PIE SHOWED 100 MR. PER HOUR. SO THE HP BOYS SAID TO WASH THE TOOLS IN THE HOT SINK."

What are they talking about?

Where do they work? Answer below.

They work in a radiation laboratory. Pigs are lead containers for very hot radioactive sources. Vaults for storing such materials are called caves. A cutie pie is a type of radiation counter, and mr. is milliroentgen—a thousandth of the basic unit of radioactivity. HP boys are the Health Physics safety-squad members. The tools could not be decontaminated in a sink for mild activity. They had to be cleaned in a sink used for very hot stuff.

DO IT THE EASY WAY

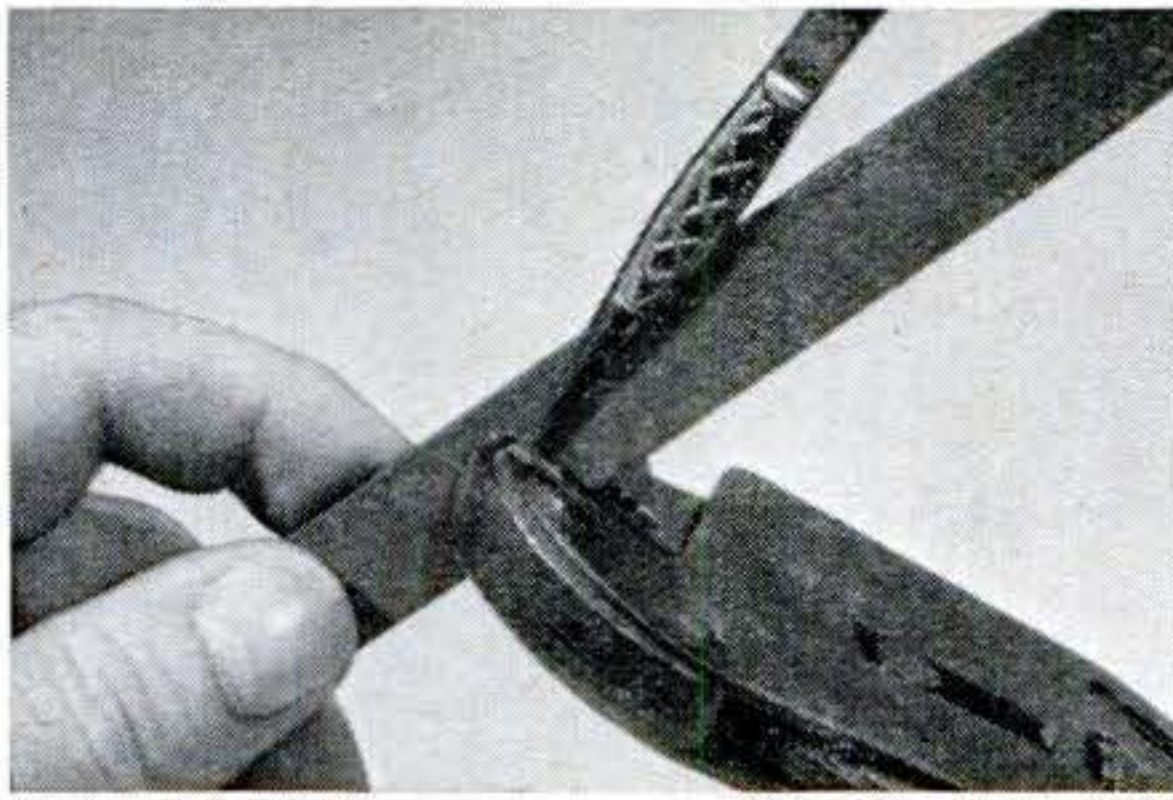

TO RESTORE KNURLING on tweezer jaws, place the jaws on a mill file and apply pressure with a lock wrench or vise.—*Ken Murray, Colon, Mich.*

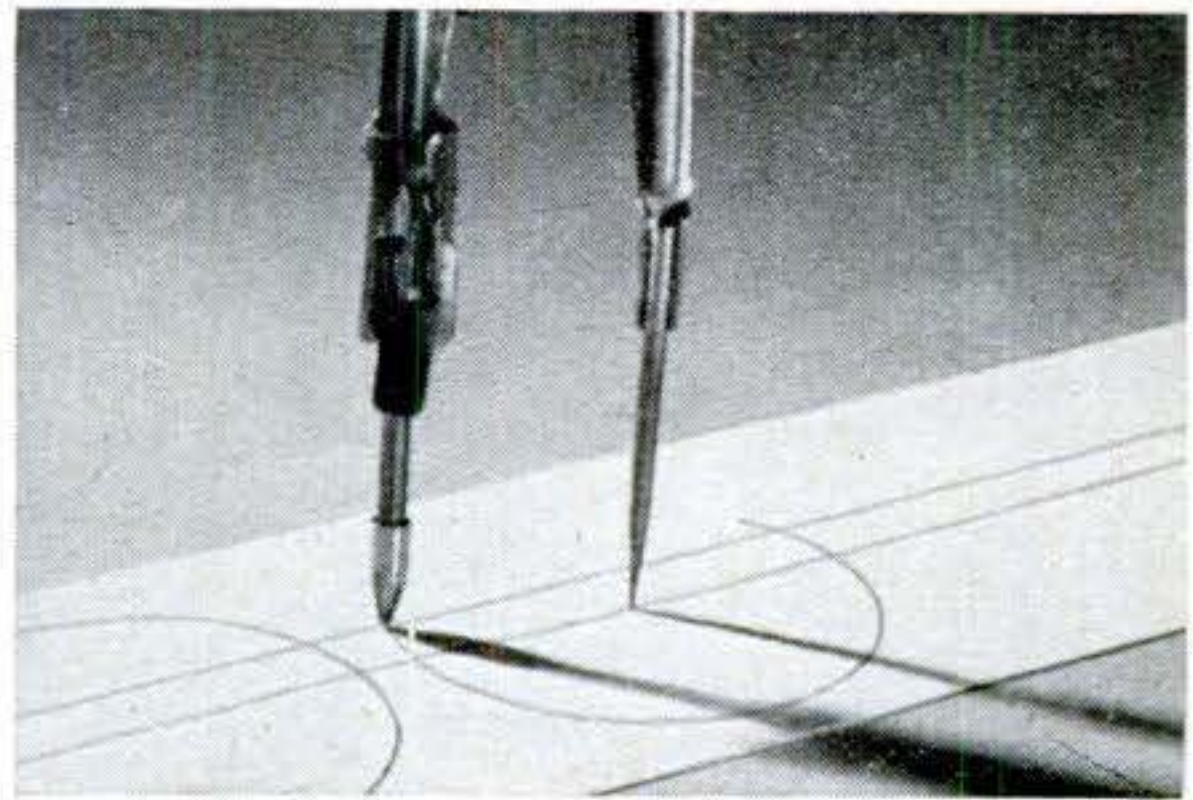

TO ELIMINATE RESHARPENING the pencil of a compass, substitute a refill cartridge for a ball-point pen. Tape the ink tube to make it the size of a pencil.

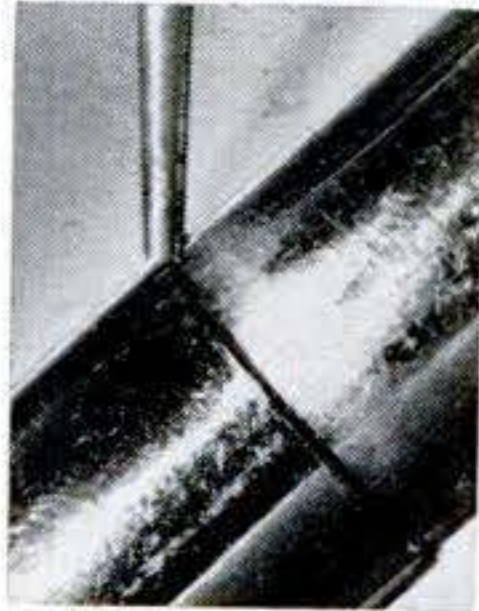

TO FREE jammed vacuum-cleaner attachments, pour a few drops of kerosene around the joint. Let it soak in for about 30 minutes and sections will come apart readily.—*R. F. Donovan, Guttenberg, N. J.*

TO AVOID RETINNING your soldering-iron tip so frequently, coil copper wire around it. This will increase heat radiation, preventing the tip from burning and pitting as rapidly.—*James Trusdle, Clyde, Ohio.*



T-Square Makes Lettering Aid

RESTING your hand on air while lettering the bottom of a large drawing makes a tough job of it. I hold a T-square across the board as shown. With a little maneuvering it makes an adequate hand rest.—*Stewart Rouse, Knightstown, Ind.*



Water Pressure Seats No-Dribble Valve for Flush Tanks

WITH only three moving parts, this new valve takes the place of the complicated and dribble-prone intake valve common in flush tanks. Instead of being closed by a float *against* the pressure of the incoming water, this valve closes *with* the pressure. The push of the water seats a

stainless-steel ball to shut off the flow. A cam connected to the float arm nudges it off its seat when water is needed.

Invented by Samuel Kass of Philadelphia, the unit can be installed in any standard flush tank with only a wrench. Price, complete with bleeder tube and float, is \$6.

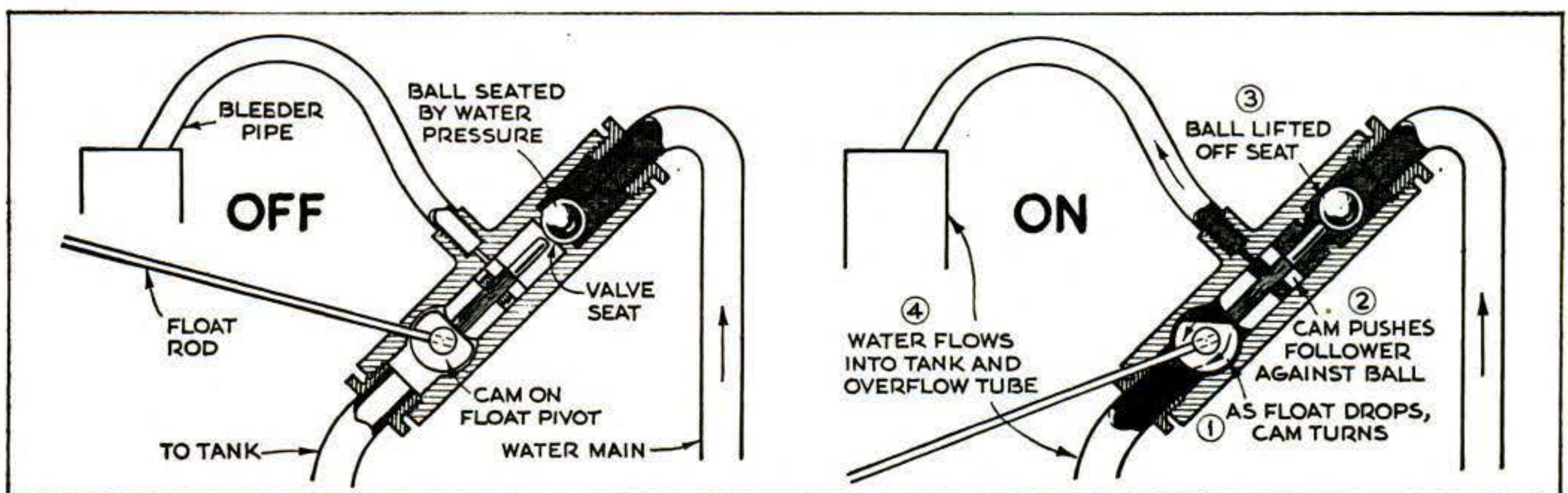

One-Evening Shop Projects

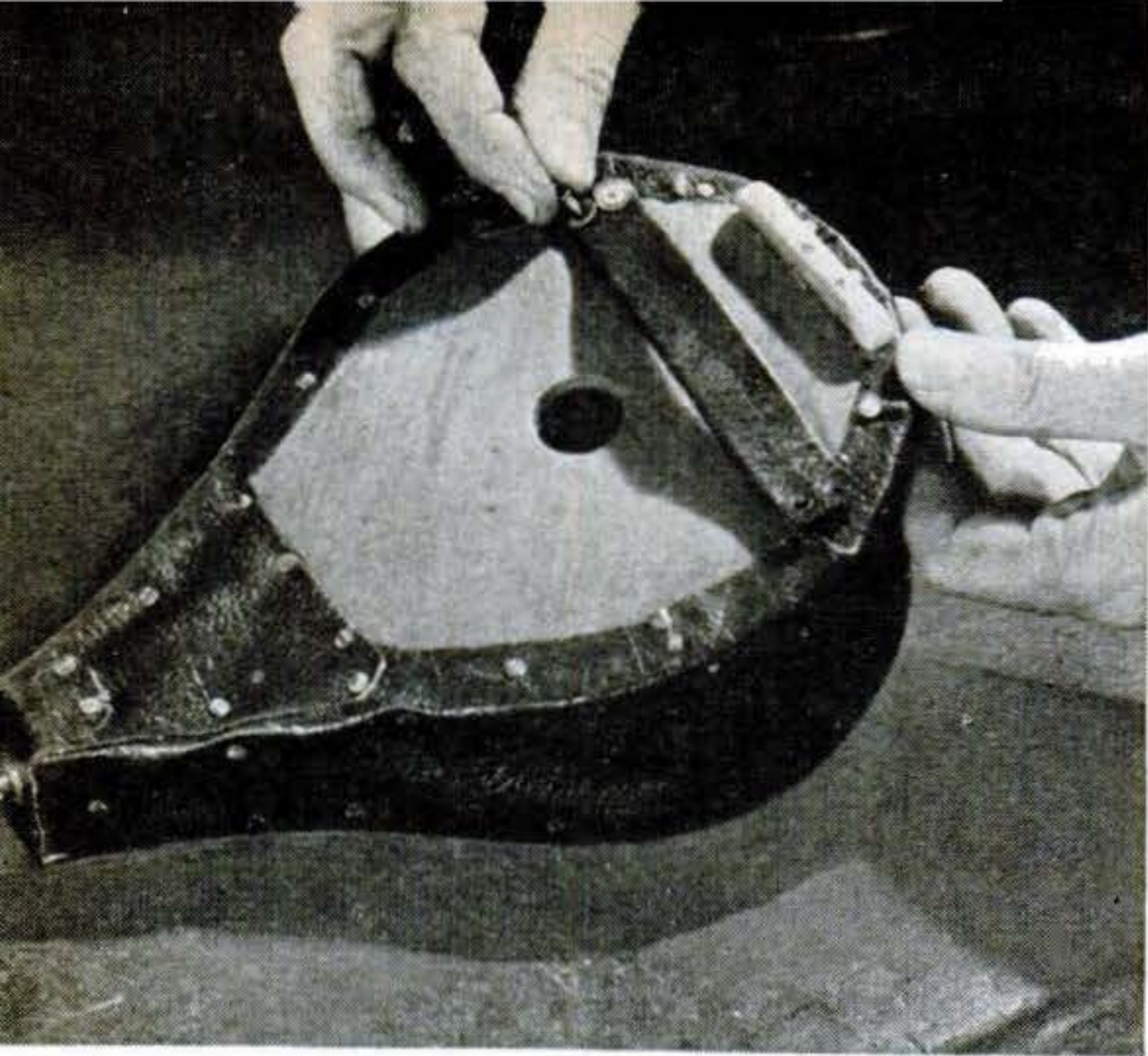

FINGER STRAP goes on pivoted side. Small wood strip gives fingers a better grip. Put a thumb strap on other side of the bellows.

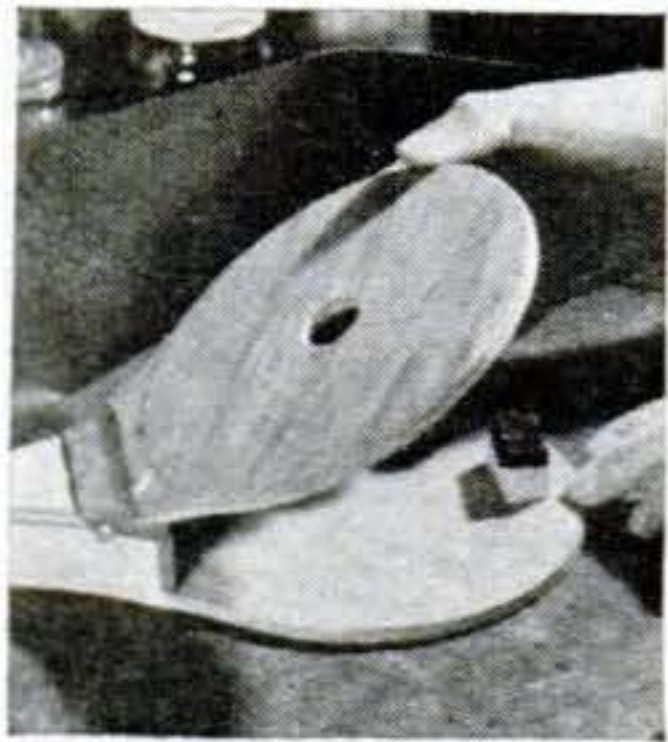

HINGE movable side with a strip of soft leather. Mount a small stop as at right.

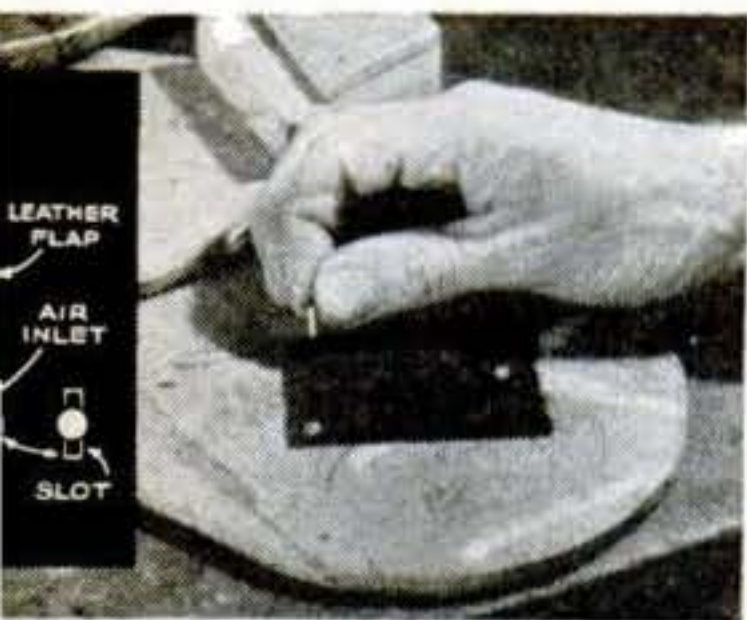

FLAP VALVE lets air in. Make it of pliable leather. Single tack at one end is only partly driven. It goes through slot in leather.

For starting a fire in a fireplace, this bellows will quickly coax a reluctant spark into a full-fledged flame. Its brass-tubing nozzle directs a blast of air just where you want it.

Cut two matching pieces of $\frac{1}{4}$ " plywood for the faces, shaping them like a pear. The fat end can be a circle of about 6" diameter. The brass tubing should be a drive fit in a hole drilled lengthwise through a spacing block sandwiched between the neck sections.

Drill a 1" hole through the center of one of the faces, and cut through the neck of this same piece. Fasten the two cut parts together with a leather hinge. Attach a flap valve inside the hole. Make a felt-padded stop block.

For the bellows you can use soft leather, sheepskin or vinyl upholstery material backed with cloth. Glue and tack it to the edges of the plywood members with the hinged piece in its normally open position. Test for leaks by holding the nozzle shut with your thumb while squeezing the bellows sides together.

Building time: two hours.



Here's an extra chair for TV viewing, easily made from an old beach chair. Rip off the old canvas, tighten up the frame as required, and screw the brace ends to the back legs to make the chair stay open during handling. Paint the frame to suit your room.

Buy about 10 yards of the burlap webbing used on the underside of upholstered chairs. Try to find webbing that has decorative striping. Cut into strips of the required length, loop the ends around the frame members several times, and tack on.

Building time: 1½ hours.

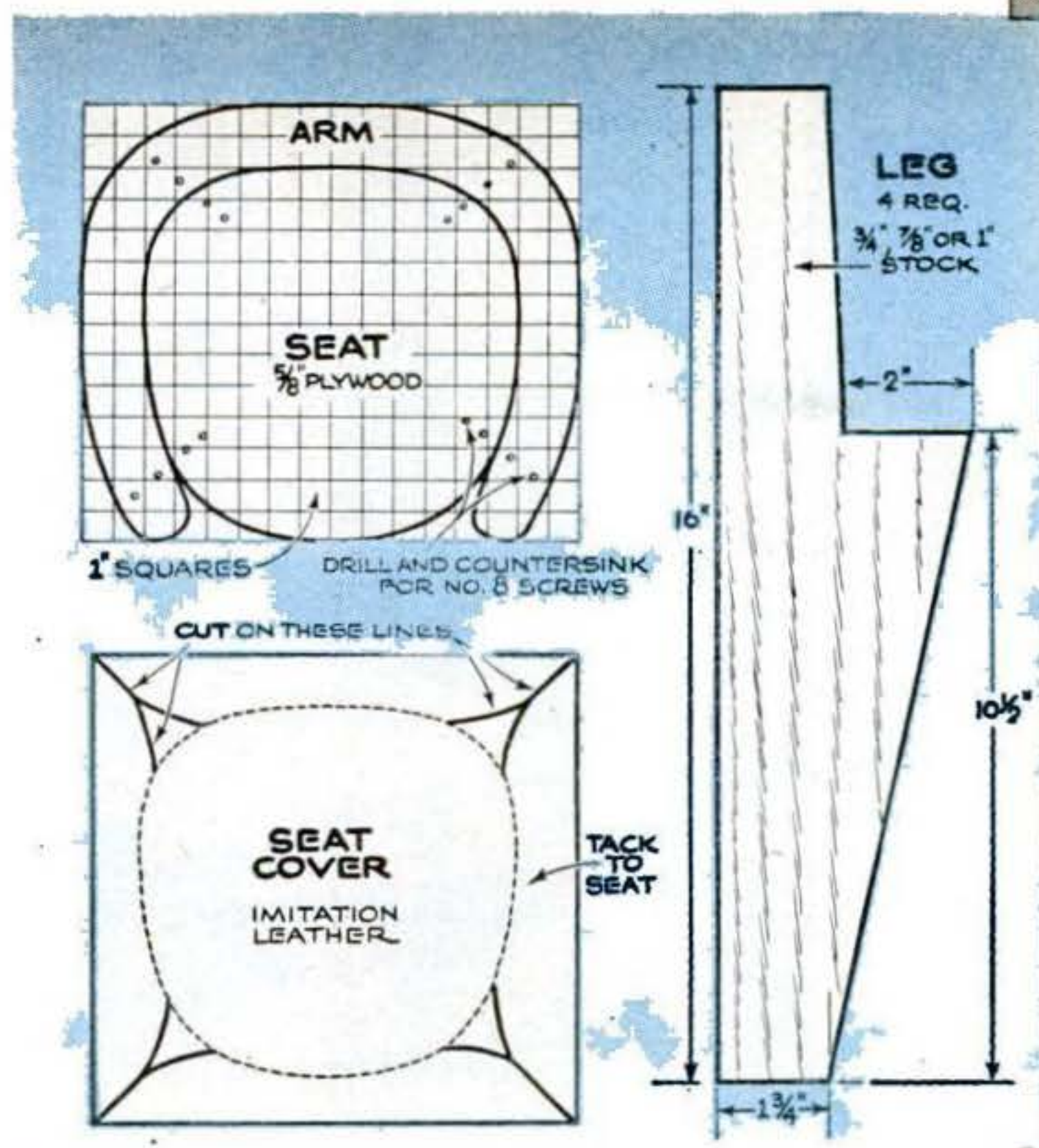

A child's chair may seem like too big a project for a single evening. But this one isn't. Besides being easy to make, it is stout and attractive.

One piece of plywood, measuring 14" by 16", will serve both for the seat and combination arm and back. A bandsaw or jigsaw makes quick work of the cutting. Four scraps of any 3/4" stock at least 4" by 16" will take care of the legs.

Sand all parts, and drill and countersink the arm and seat at the indicated points for 1 1/4" flathead screws. Assemble

with glue as well as screws. Fill the arm screw holes, and paint or stain the chair as desired.

To fit an imitation-leather seat cover, make a Y-shaped cut at each leg. Use quilting cotton as padding. Pull the leather tight and tack it underneath the seat. Space upholsterer's nails evenly around the edge.

Building time: four hours.

For an artistic touch in your home, build this palette tray. Two plastic drawer pulls and a 8 3/4" by 13" sheet of 1/4" birch-surfaced plywood are what you need.

Bandsaw the plywood to oval shape. Make the thumb hole by first boring a 1" hole. Then cut to the outer edge and round the corners with a wood rasp. Sand all surfaces. Countersink holes underneath for the handle screws.

Apply a coat of shellac, let it dry, then sand lightly with fine paper. To represent the colors an artist might spread on the palette, apply irregular splotches of lacquer, paint or enamel to the wood. Wax the wood after this has dried. Screw on the handles and glue thin felt to the tray bottom.

If you wish, form a metal fence around the edge to keep things from sliding off. Building time: one hour.



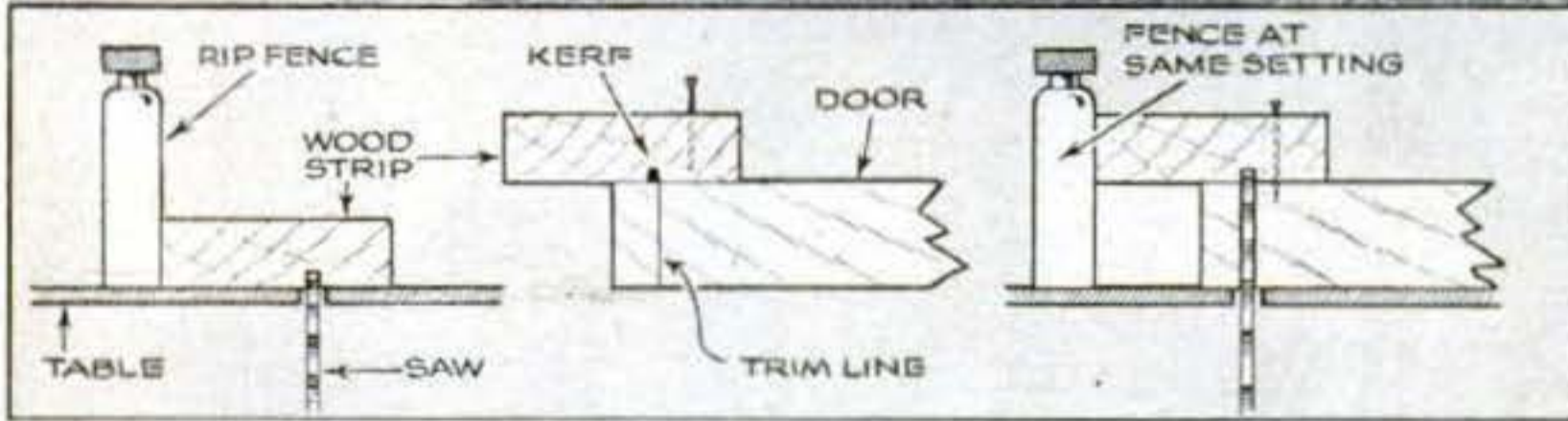

Circular Saw Trims Doors

A DOOR can be trimmed top and bottom in minutes on a circular saw.

In a straight strip of wood a bit longer than the door is wide, rip a kerf $\frac{1}{8}$ " deep about 1" from an edge. Leave the rip fence locked. Tack the strip across the door with a couple of finishing nails, aligning the kerf with the trim line you have marked on

the door. Get a helper or set up a roller guide to hold the far end of the door as you make the cut.

Adjust the saw blade to cut through the door, and guide the door by keeping the strip against the fence. The two nail holes can be puttied, and won't show after the door is painted.—*Glenn A. Wagner, Delmar, N. Y.*

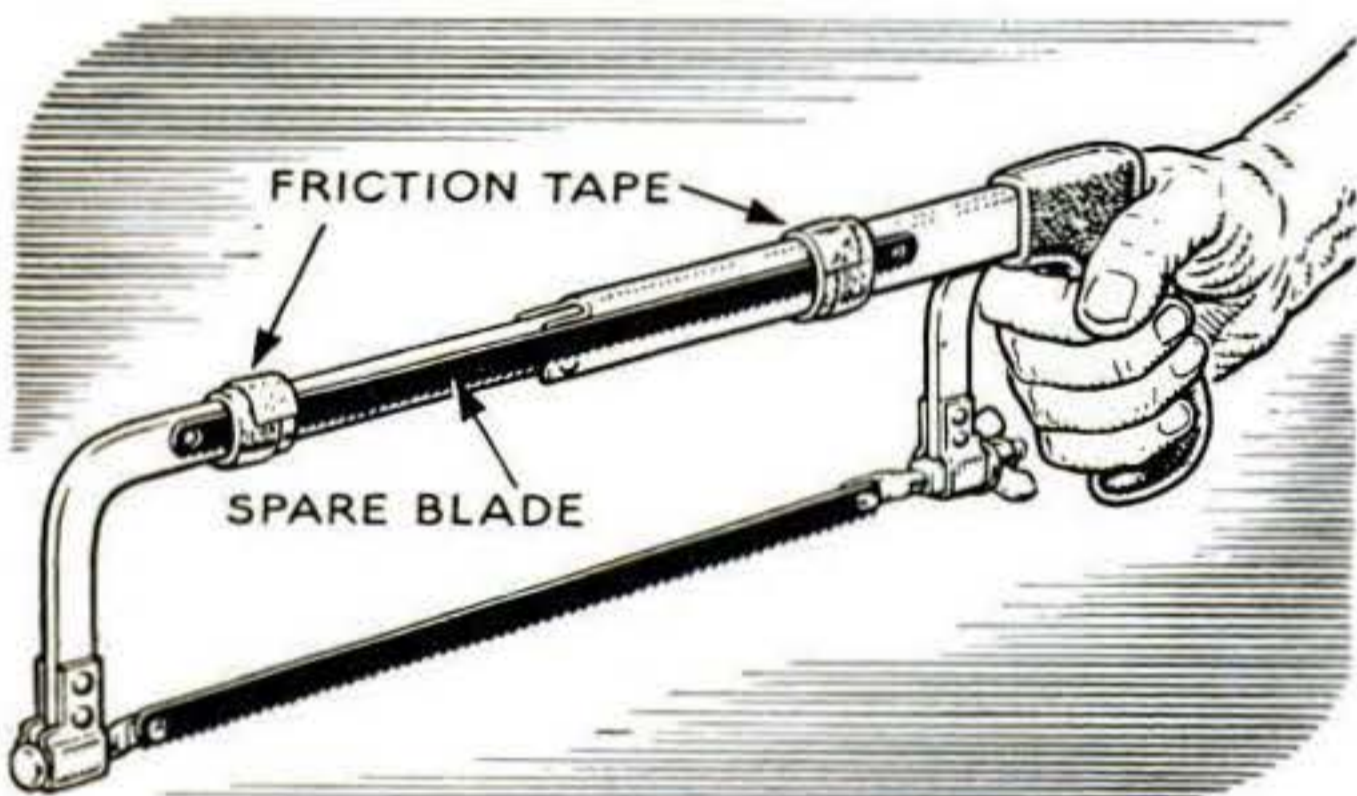

Tape Keeps Extra Blade Handy

I HITCH a spare blade to the handle of my hacksaw. Then I have a replacement always handy and don't have to paw through a loaded tool box to find a blade in an emergency.—*W. Fitzpatrick, Yonkers, N. Y.*

Scrap Pipe Forms Tripod Stands

PORTABLE stands that are light but strong, can be made of 1" pipe welded into tripods. They are useful for racking pipe or lumber off the ground. Weld a curved



piece of pipe to the tops of the stands and they will also hold drums as shown at left. Easily carried and set up, they are fine where frequent moving is necessary.—*E. V. Reyner, Townsend, Mont.*

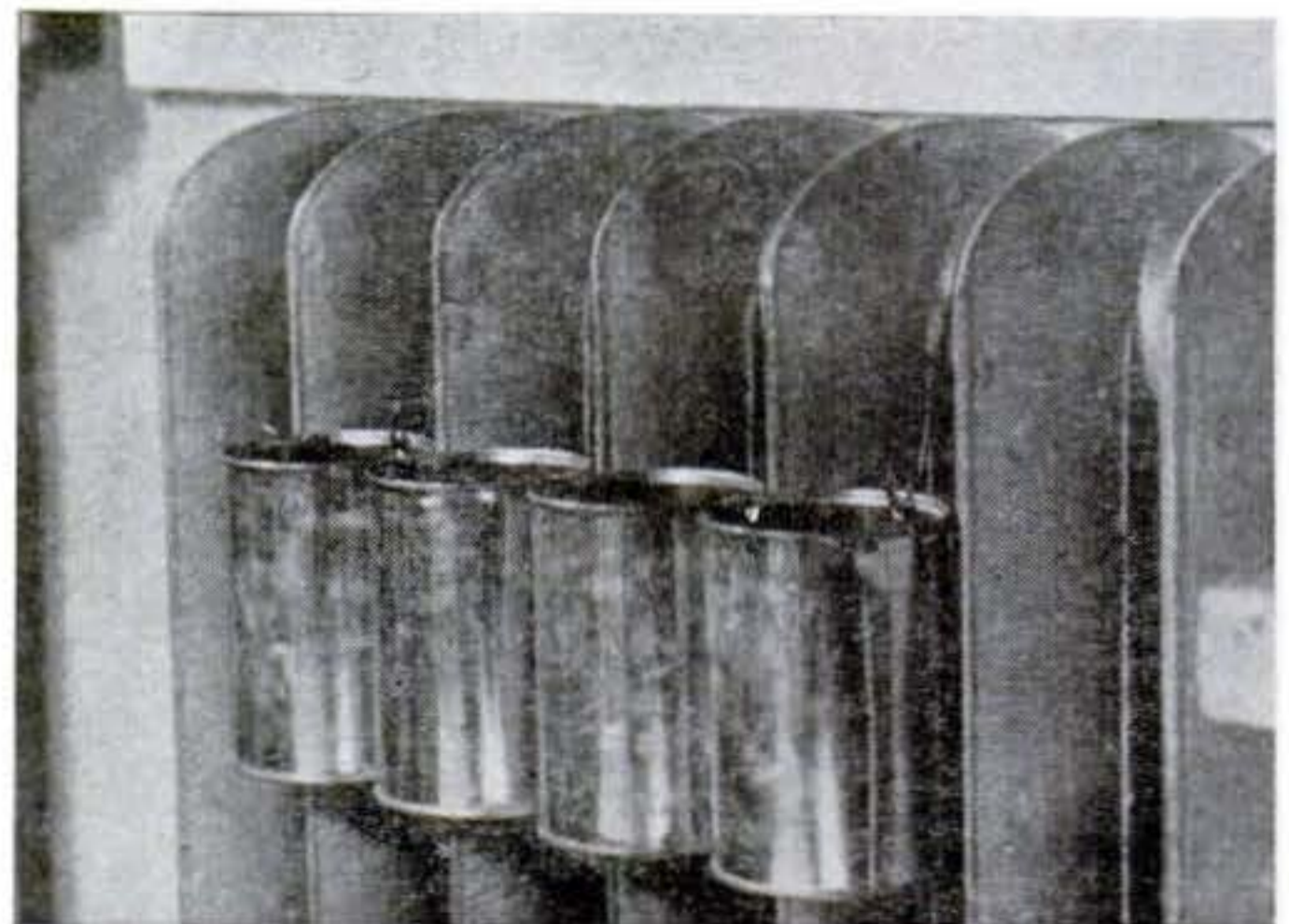

Tin Cans Make Humidifier

SOLDER together three or four 3"-diameter tin cans and you have an efficient home humidifier. Hooks cut from a wire coat hanger will hold the unit to a radiator.—*A. Zanelli, Wyckoff, N. J.*

Sawing Tapers to the Line

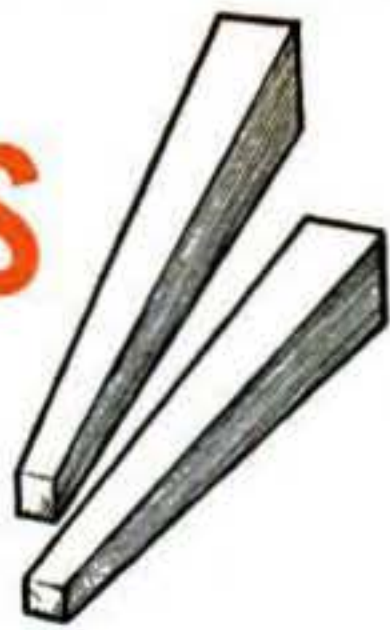

These homemade adjustable jigs make taper sawing a pleasure instead of a peril.

ONE of the tougher operations on the circular saw is cutting long, narrow, tapered pieces such as table legs or pedestals. The fixtures sketched below will make it a lot easier to cut tapers, and they will relieve your fingers of the responsibility of guiding narrow work between fence and blade.

One of the fixtures can be knocked out in minutes. Two strips of $\frac{3}{4}$ " stock joined by a rectangular piece of $\frac{1}{4}$ " plywood are all you need. A small block of wood may be added for a handhold. One strip is permanently nailed to the plywood, while the other, notched, strip is fastened at the leading end by one nail. It is set to taper position at the trailing end by another nail that is driven in part way.

A useful accessory for the jig is a V-block attachment. This V block is substituted for the notched strip, and work previously tapered can be chamfered on the tapering corners—a ticklish job without the help of the jig. About 12" long and 6" wide is a good size for the jig.

For a permanent shop fixture the quick-setting jig is better. The construction is basically the same but it uses heavier stock, is assembled with screws, and has an adjusting slot with locking wing nut and a hardwood clamp to hold the work. A somewhat shorter V block can be clamped in place on this jig, eliminating the necessity of removing the notched strip.

Use a stop, clamped to the fence, to keep you from pushing the clamp and bolt into the saw blade. When making long cuts, down to the end of the work, the clamp and bolt should be removed from the side of the jig. A coat of shellac followed by a coat of machine gray will complete your new shop accessory.—Glenn A. Wagner, Delmar, N. Y.



THE JIG IS SET by lining up the taper layout lines on the stock with the miter groove in the saw table. Then adjust the fence to line up the stock for the cut.



THE JIG IS GUIDED by the rip fence. Fingers need not come near blade. Little finger straddles fence.

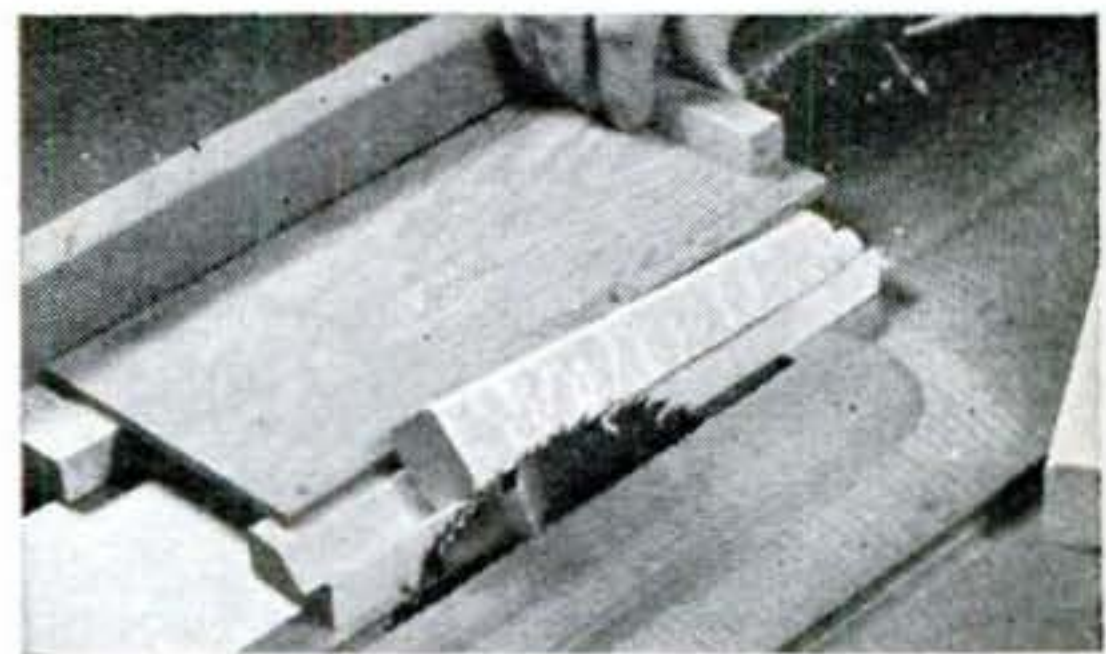

V ATTACHMENT IS SUBSTITUTED for the notched guide strip for cutting chamfers on the tapering corners. Work should be held down lightly to prevent vibration.

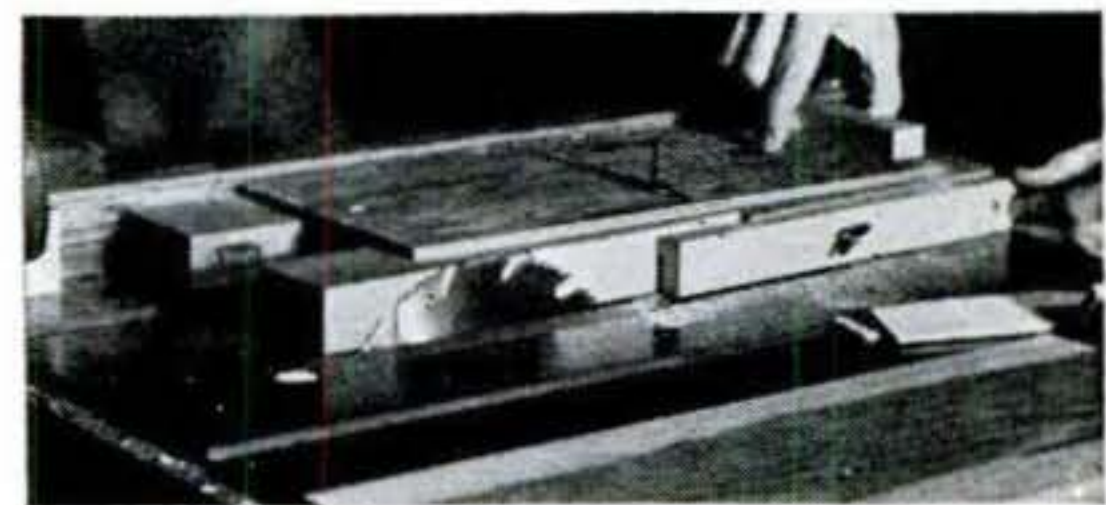

THE QUICK-SETTING JIG does a production run of model-airplane wings. Stop is clamped to fence.

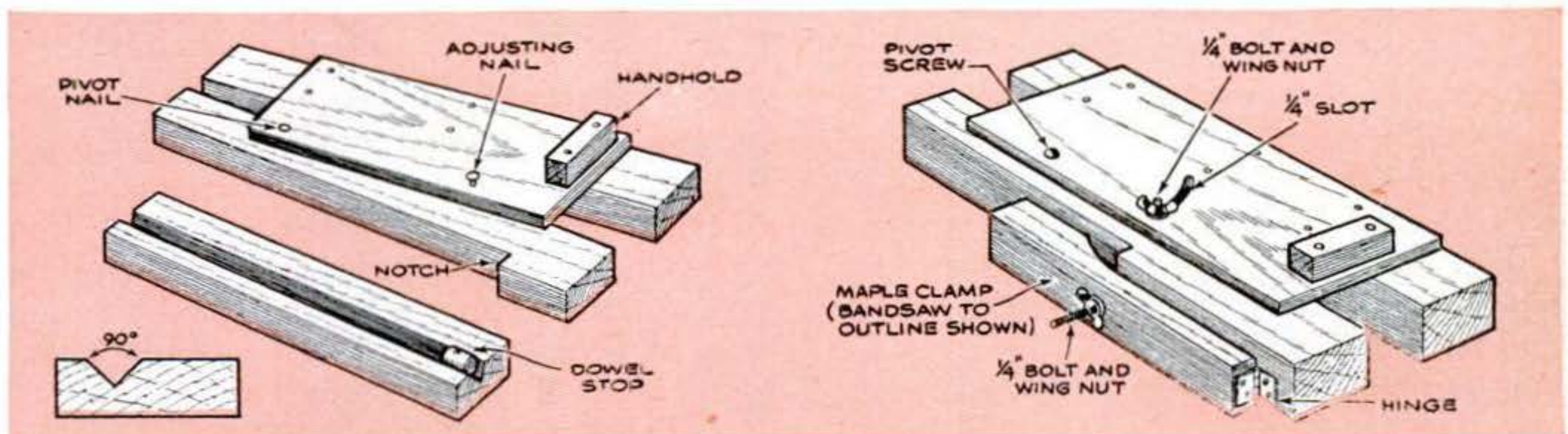



New Tools



Keyhole Saw Needs No Hole.

Powered by any heavy-duty $\frac{1}{4}$ " electric drill, compressed-air drill or flexible shaft, this saw speeds keyhole sawing because no starting hole is needed. In use, the tool is held tightly against the work and rocked into an upright position with the guide used as a fulcrum. A built-in blower cools the saw and also

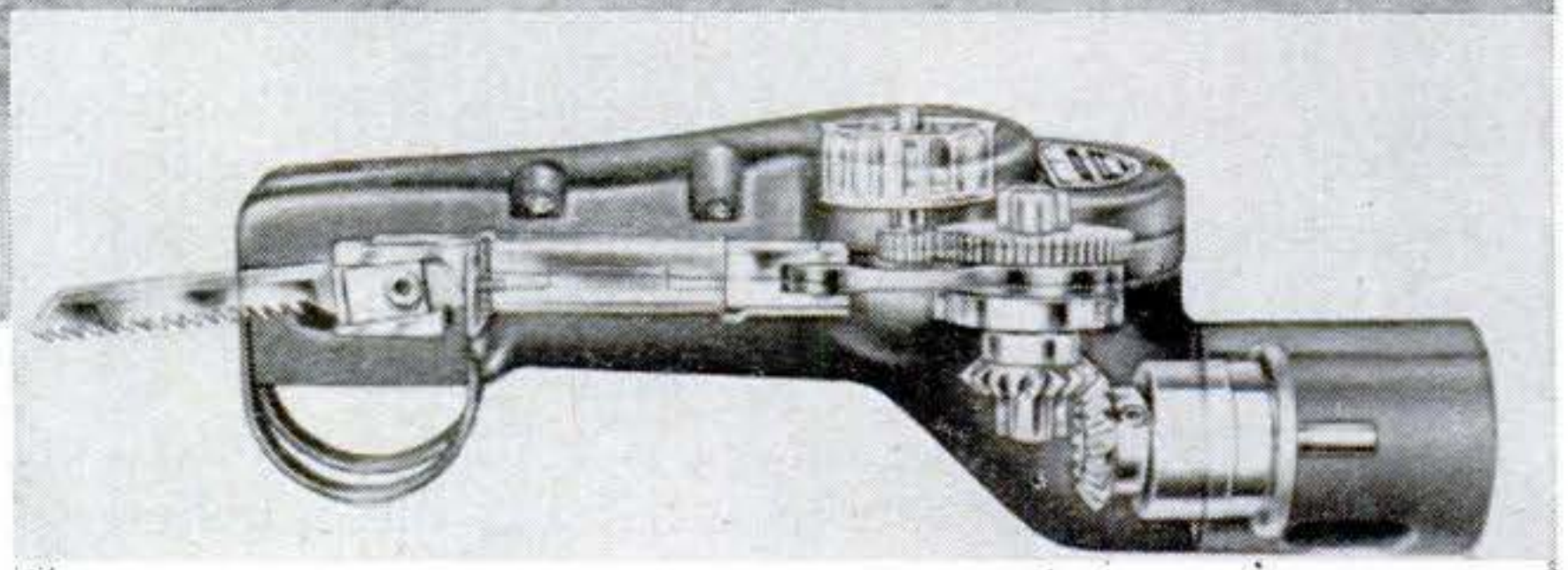

blows sawdust away from the cutting line. Nearly any kind of material can be cut with the special blades that are available as accessories. The stroke is $\frac{3}{4}$ ". *RCS Tool Sales Corp., Joliet, Ill.*

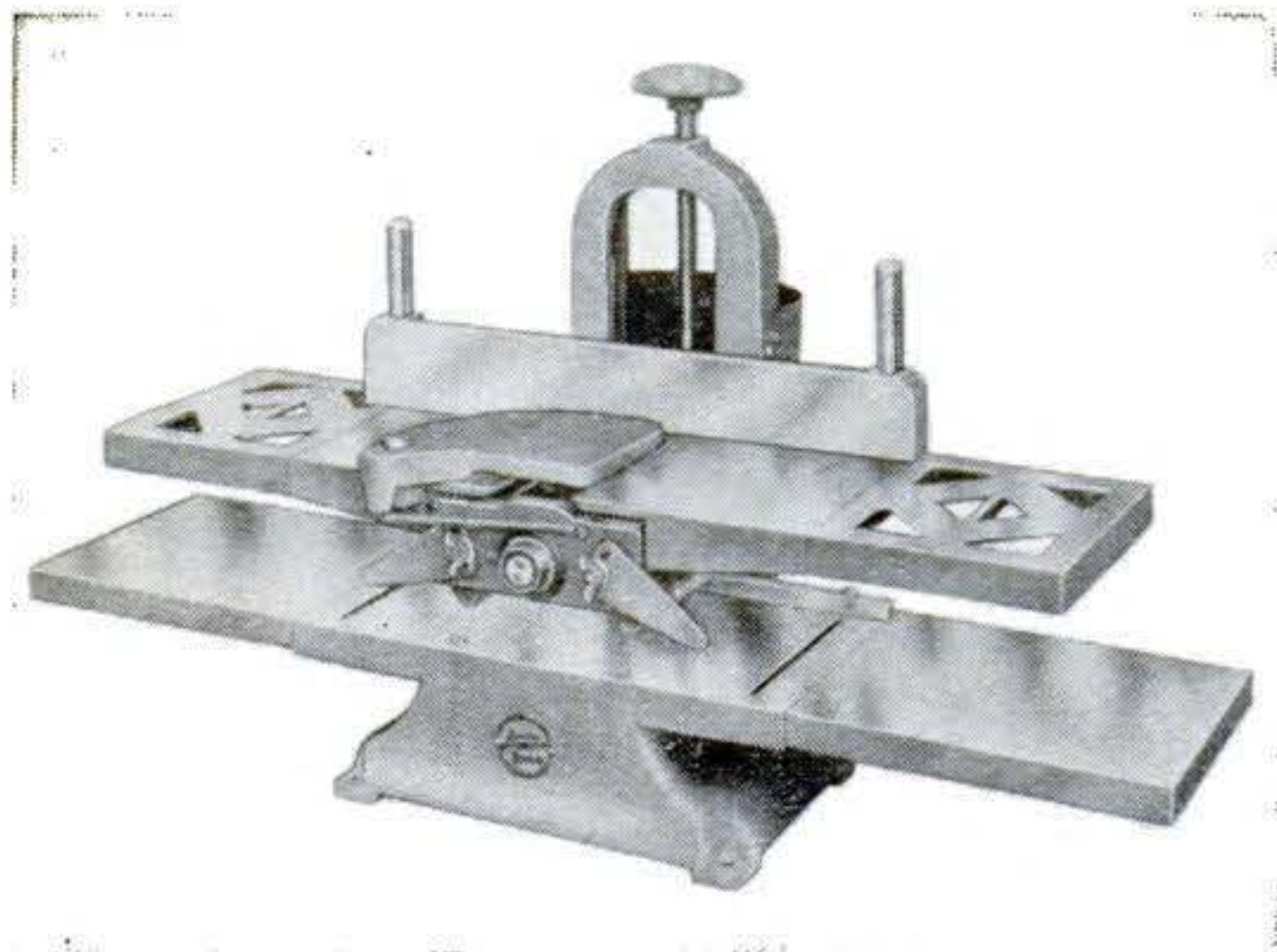

Tool Joints, Planes and Molds. When the upper table is used, this tool is a 6" jointer. When the lower table is used—with the work fed from the opposite direction—the tool is a thickness planer. By installing molding knives in the head, the lower table can be used for molding. Lumber $4\frac{1}{2}$ " thick and 11" wide can be planed. *Toolkraft Corp., Springfield, Mass.*

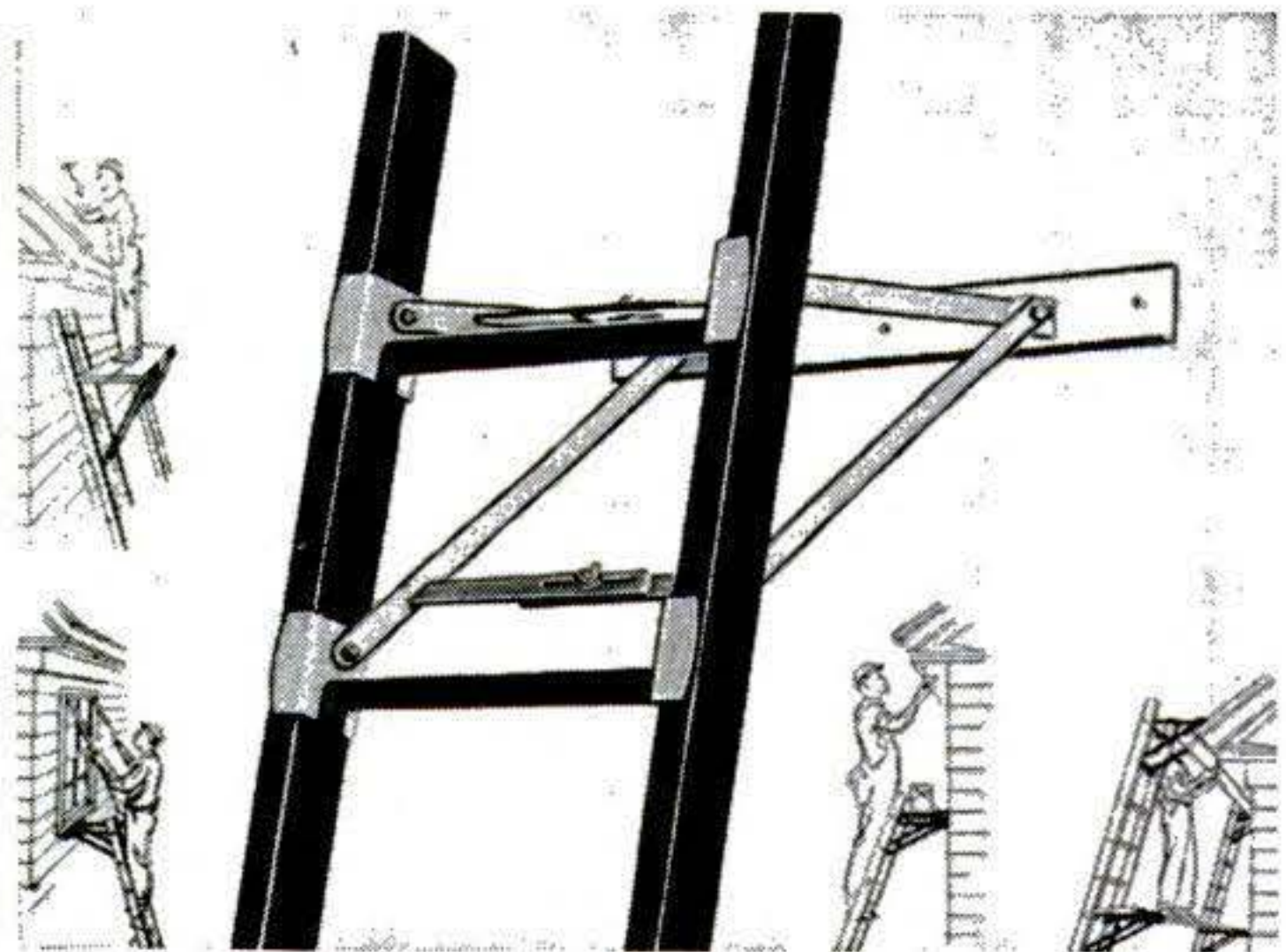

Ladder Bracket Adds Reach. This bracket holds a ladder away from the house, protecting gutters and cornices and making it easier to reach windows and roof projections. The swivel bearing plate positions itself. Used in pairs, the brackets support a scaffold and may be fastened either inside or outside the slope of the ladders. *Steadfast Equipment Co., Thornwood, N.Y.*



Bolt-Clearance Sockets. This set of long sockets lets you reach many hard-to-get-at adjustments without extensions. They are especially suited for ignition, carburetor, radio and dashboard work. The eight sizes run from $3/16''$ to $7/16''$. The sockets have a $1/4''$ drive and are 2" deep. *Bonney Forge & Tool Works, Allentown, Pa.*



Gearless Sander. Servicing problems are held to a minimum by the gearless design of this sander. A universal motor revolves the abrasive pad in a $1/4''$ -diameter orbit at 4,000 r.p.m. The tool is $4\frac{1}{8}''$ wide, $6\frac{1}{2}''$ high, and $9\frac{1}{2}''$ long. *Porter-Cable Machine Co., Syracuse, N.Y.*



Detachable Hook for Steel Tapes. Measuring long lengths of pipe, sheet metal and other big work is simpler with this hook for the end of the tape. Made to fit $1/4''$ or $3/8''$ Starrett steel tapes, the hook is serrated to provide a secure grip. *L.S. Starrett Co., Athol, Mass.*

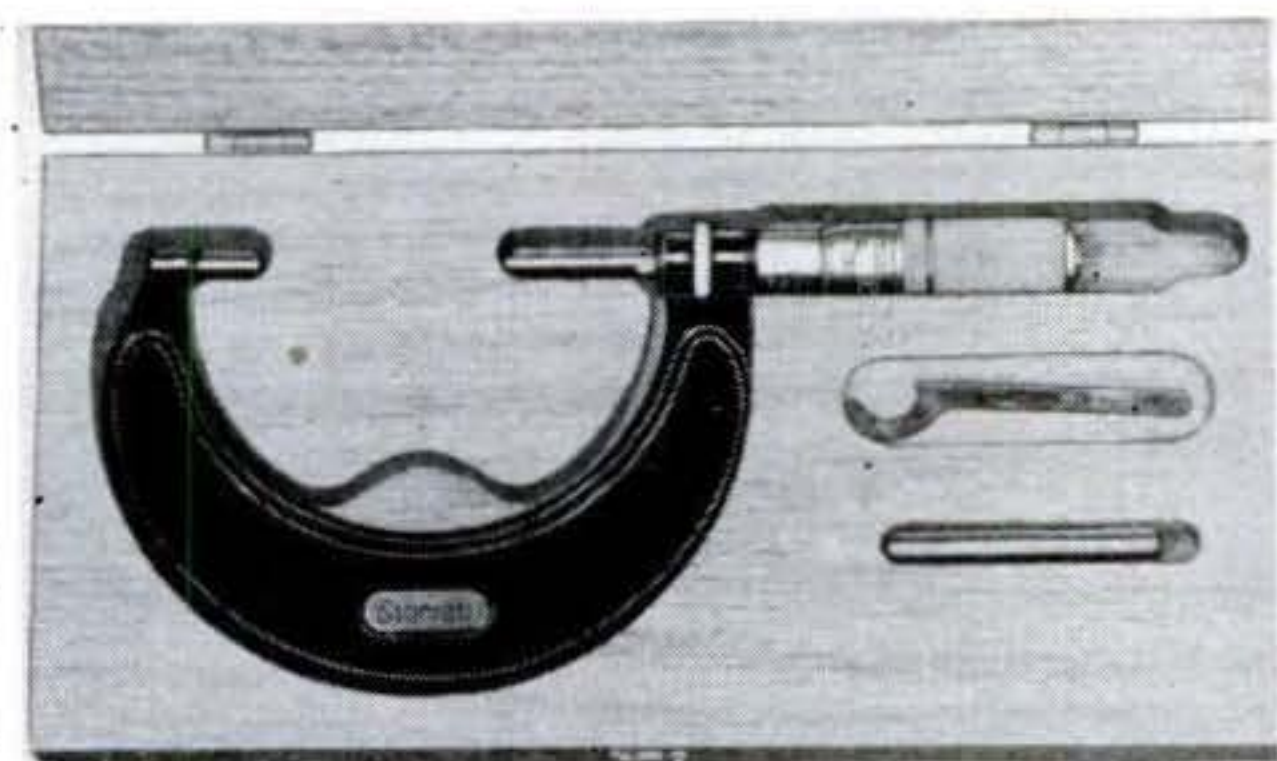

Micrometer for Crankshafts. The range of this tool— $1\frac{1}{2}''$ to $2\frac{1}{2}''$ with a 3" frame—handles most crankshaft diameters. The reading point is on the underside of the thimble so it shows when the mike is in use. *L.S. Starrett Co., Athol, Mass.*



Hone Carries Its Own Coolant. No special skill is required to turn out highly finished surfaces on cylindrical and tapered parts with this hone. It covers diameters from $1/4''$ to 3", using abrasive sticks that are available in all grit sizes. The oiler has a finger-tip control to regulate the coolant flow. *Universal Power Sprayer Co., Plymouth, Mich.*

How Compressed Air Can Help You

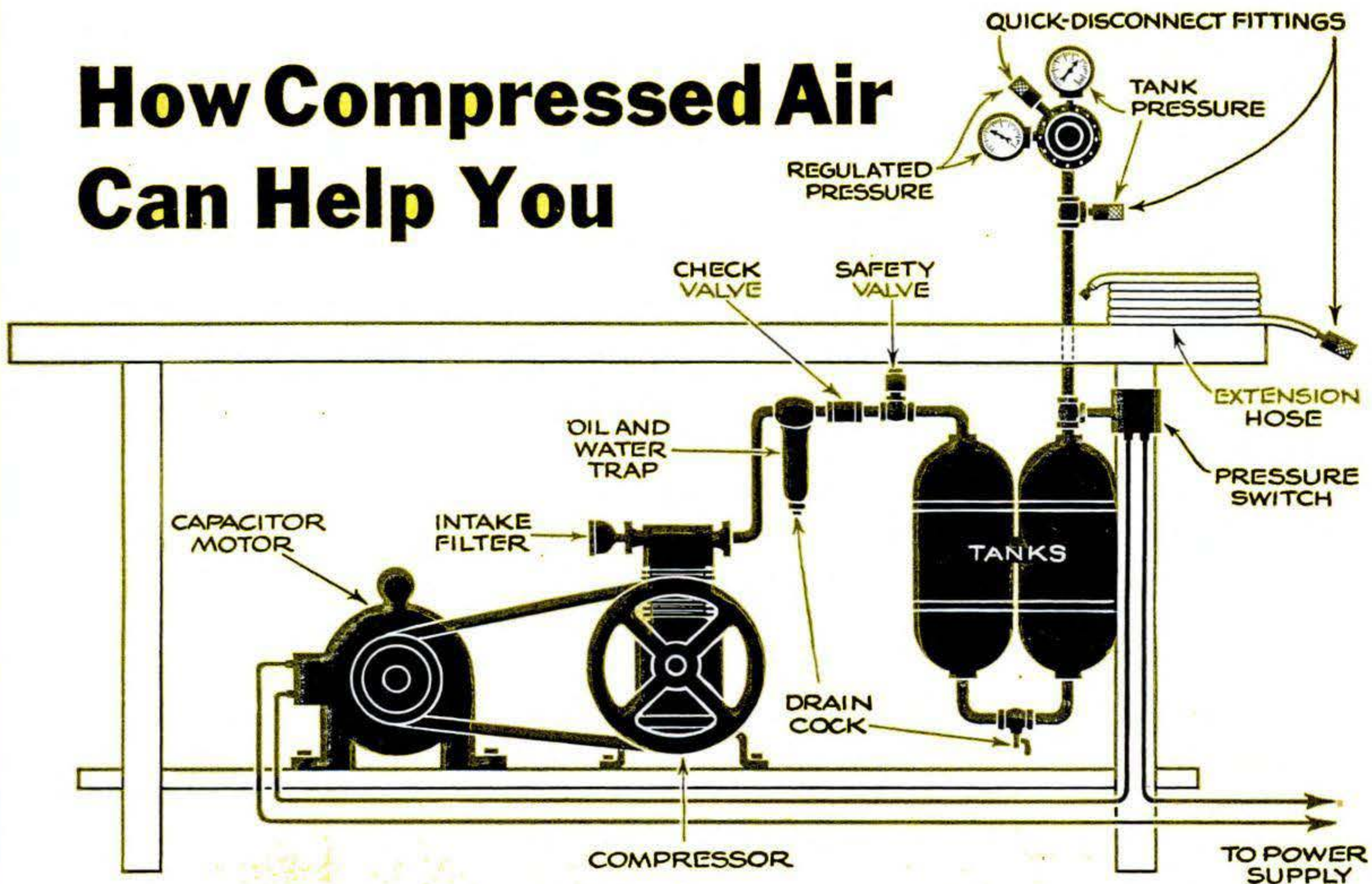

Compressed-air system can be installed under workbench, provided you use a belt guard.

Here's a chore boy you can cram into a tank and put to work at dozens of jobs in your workshop and garage.

By Howard G. McEntee

IN CASE you think an air compressor would be a luxury for your shop, let me tell you different. There are almost limitless applications for air under pressure. Sure, you do your painting very well with a brush. Where else would a compressor help? Well, just see what you have been missing.

You can hitch that air to a gas torch for a hot, clean flame that makes a soldering iron feel tepid; you can use a nozzle for blowing out chips or sand; you can tap off a little pressure to aerate an aquarium; you can run an extension to the garage for blowing out gas and oil lines, testing for engine-compression leaks, touching up the results of your wife's fendering through traffic, and, of course, inflating tires.

Couple a hose to a small sandblasting box and you can etch frosty designs on plastics, clean spark plugs, satin-finish tools or silverware and clean grime from statu-

ettes and ornaments. A whole new field of decorative finishing is opened to you: flocking, crinkle-finishing and lacquering. If you do production runs in your shop, you will find a pneumatic vise the fastest work grabber you have ever seen. The list grows as you become air-minded and shop the surplus marts for small pneumatic tools.

The compressor. This is the backbone of your air system, of course. I favor a

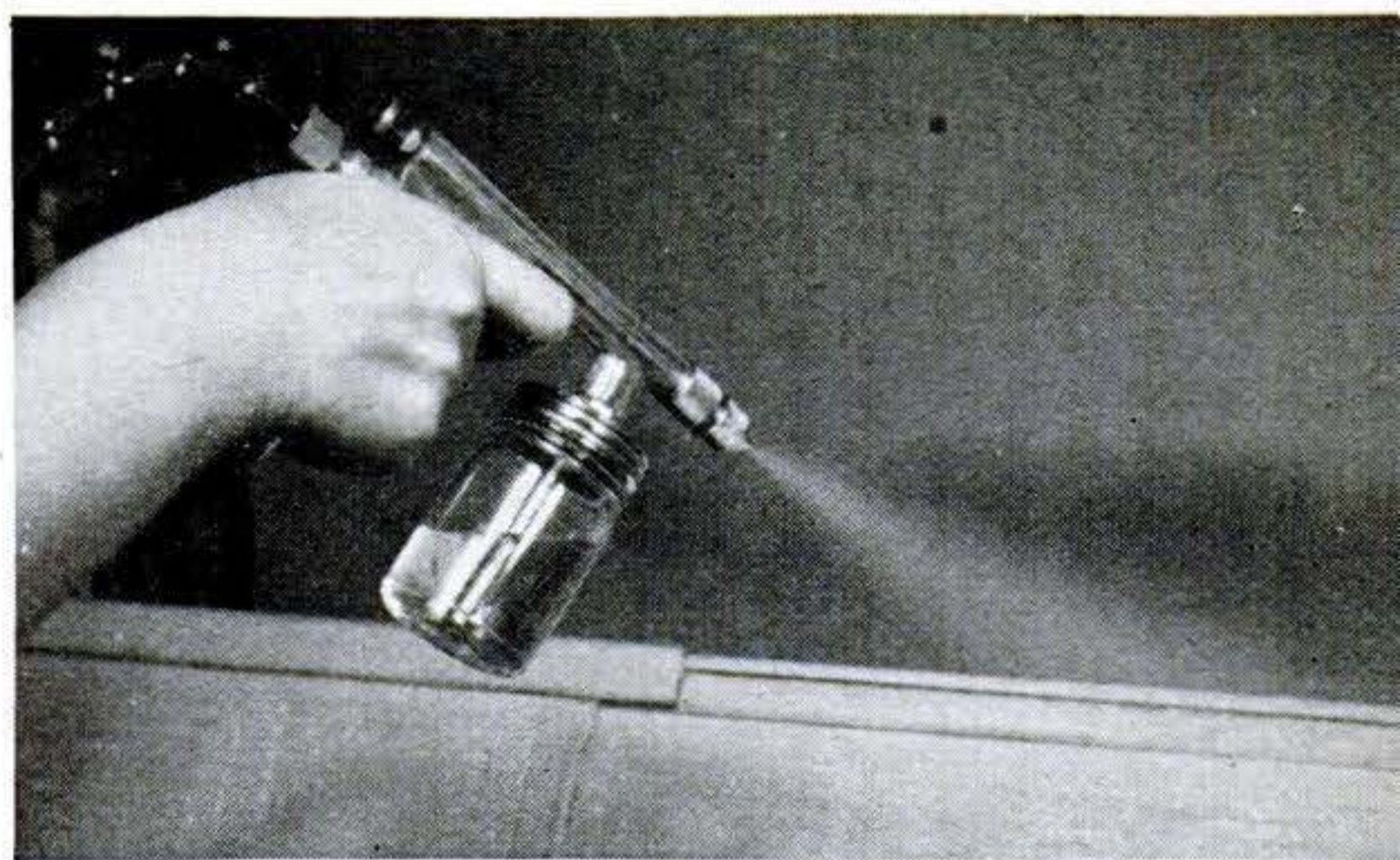

SPRAYING PAINT is the classic use for compressed air. It is not only far faster than brushing but it also does a better job.

piston job; the diaphragm types are designed for a direct hookup to spraying equipment, rather than maintaining pressure in a tank. Try your refrigerator serviceman for a unit with good bearings, valves and piston fit. Don't turn down a refrigerator compressor simply because of its ancient vintage. I salvaged a real old-timer, in good condition, for five bucks.

The old ones are ruggedly built and a little leakage in the valves may even help. It allows the residual air pressure in the cylinder to drop between runs so that the motor doesn't have to start up under full load. Some refrigerator compressors are equipped with fan blades built into the drive pulley. If yours is not, and you expect to do spraying or other continuous operations, mount a small cooling fan to blow on the cylinder fins. A friction drive off the belt will spin it.

Motor. A 1/3-hp. electric motor is ample to drive most small compressors, and a 1/4-hp. might do. The motor should be the capacitor-starting type, though a less expensive split-phase motor will serve if you fit a centrifugal pulley on it, or use an automatic pressure valve with an "unloader." This gadget releases pressure in the cylinder to reduce the starting load—in the same manner as slightly leaking valves.

Pulley ratios should be selected so that the system reaches its maximum pressure as rapidly as possible without overloading the motor. Be sure the belt is tight, because a loose belt may not turn over the compressor if it has stopped on the compression stroke. Friction of the loose belt may then hold the motor speed down so that it runs on the starting winding. And that may burn out the motor.

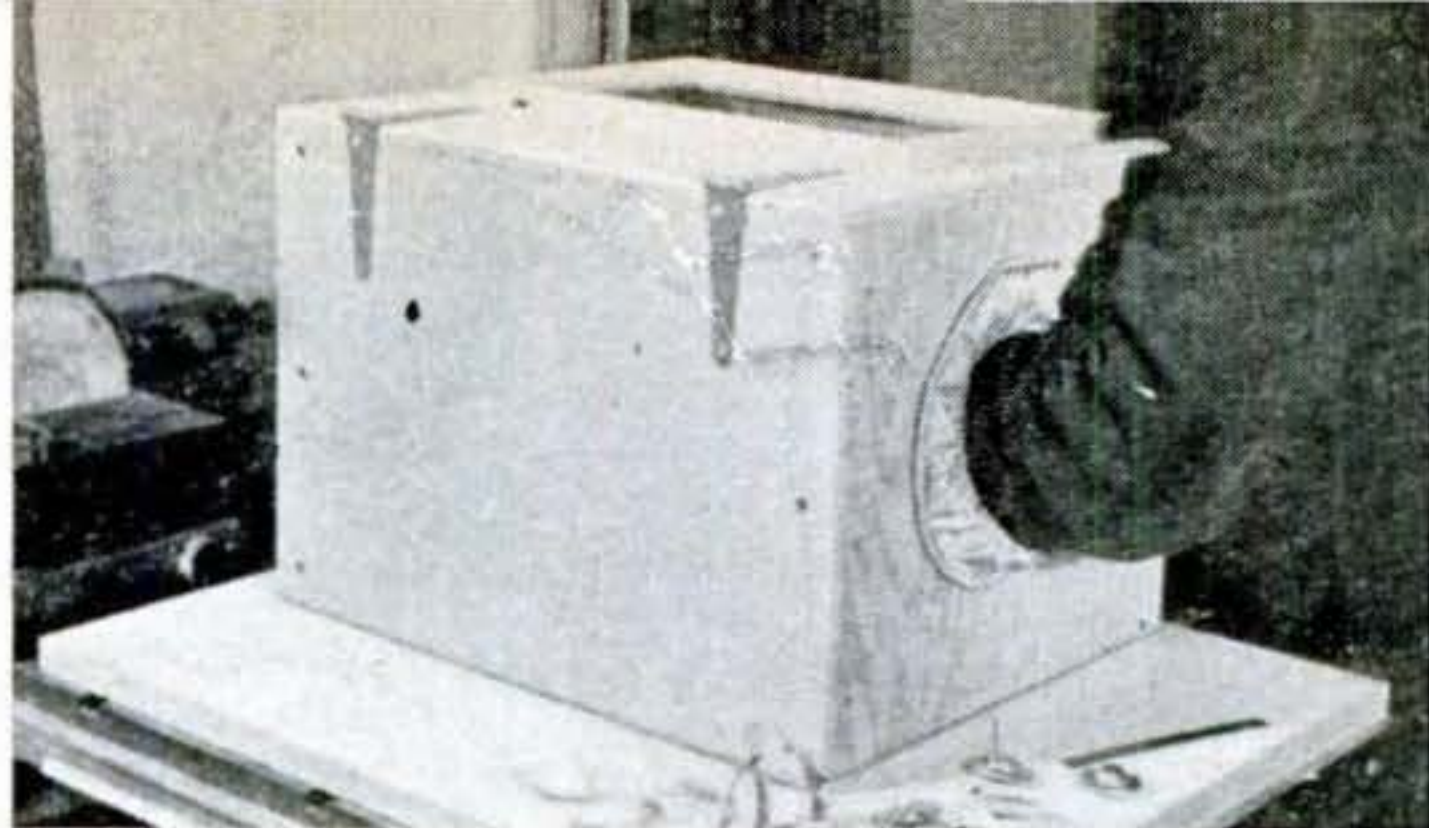

SOME SHARP SAND, a tightly built box (see page 215) and plenty of air will enable you to etch plastics, satin-finish metal parts.

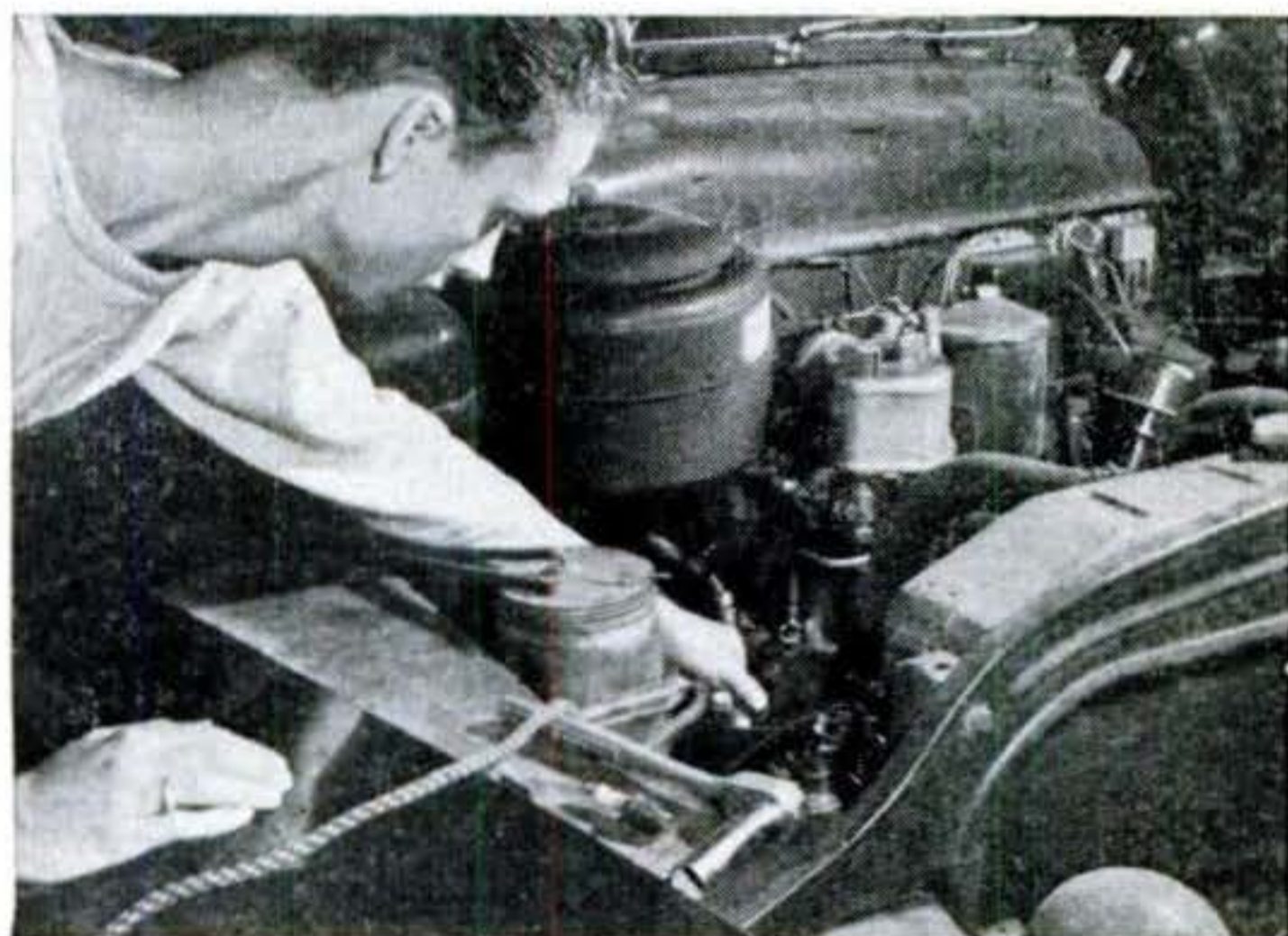

AN OLD SPARK PLUG, converted to an air fitting, is a big help in checking for compression leaks in your auto engine.

Controls. I used a manual on-off switch for several years, relying on the pop-off valve to backstop me if I forgot. An automatic pressure switch, however, is better. It operates the compressor only when the tank falls to minimum pressure and shuts it off when full pressure is reached. A modest differential between the cut-in and cut-out pressures, say 15 lb., will keep the motor from running every time you use a

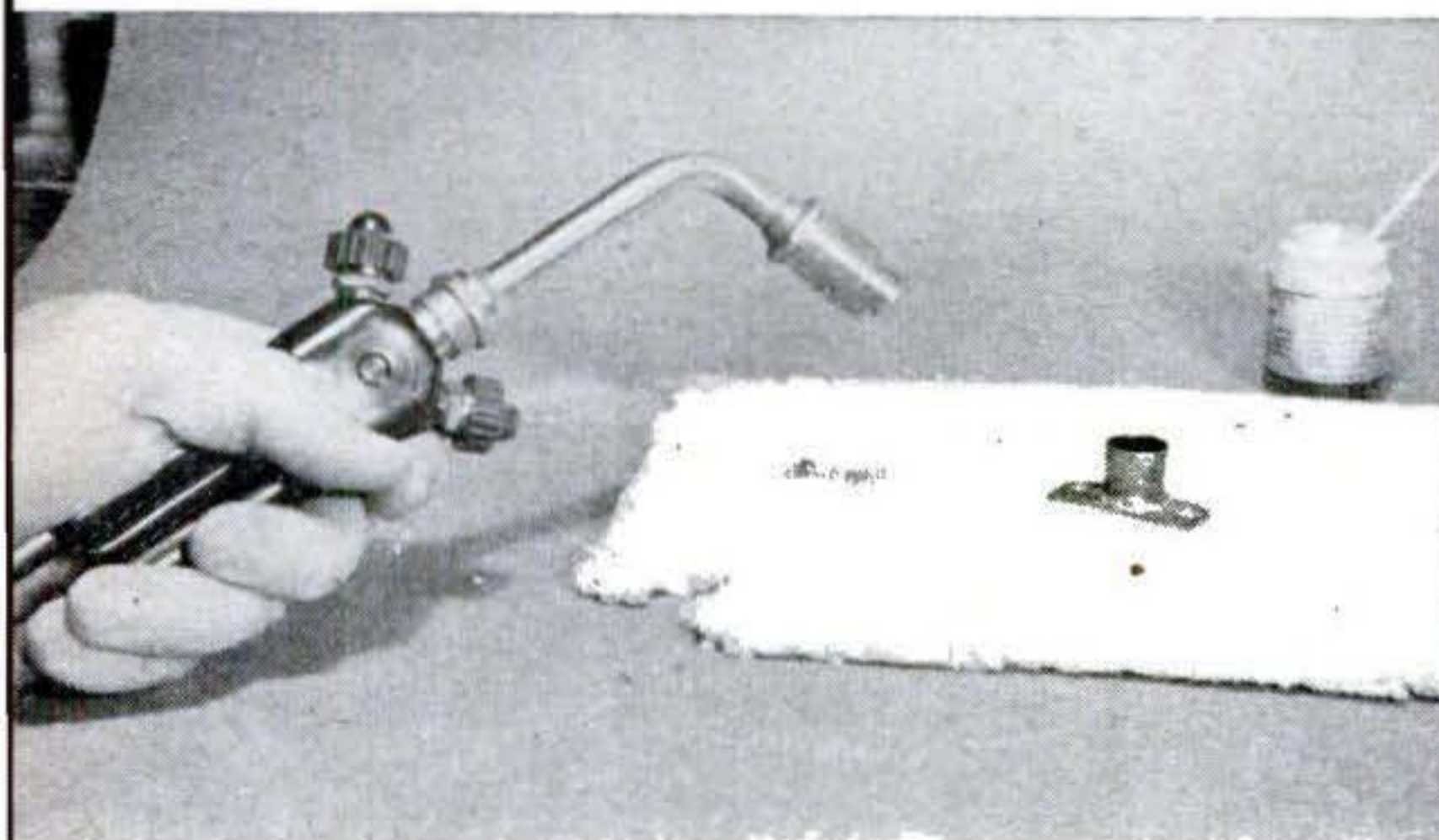

COOKING GAS, boosted with compressed air, produces a hot, clean flame suitable for silver soldering and brazing.

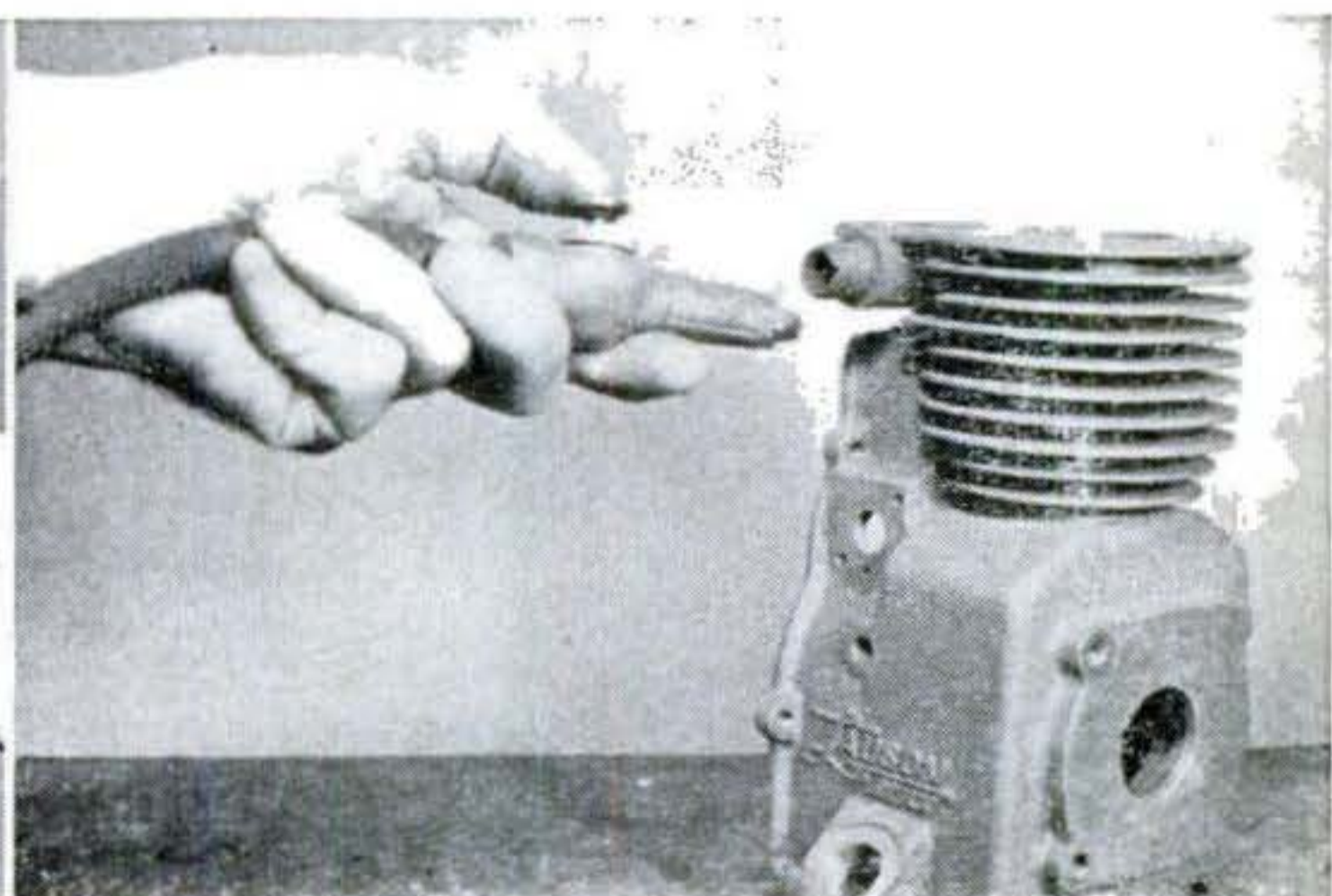

SHOT FROM A BLOWING NOZZLE, a forceful stream of air will clean castings, blow out dirt or chips, and dry odd-shaped objects.

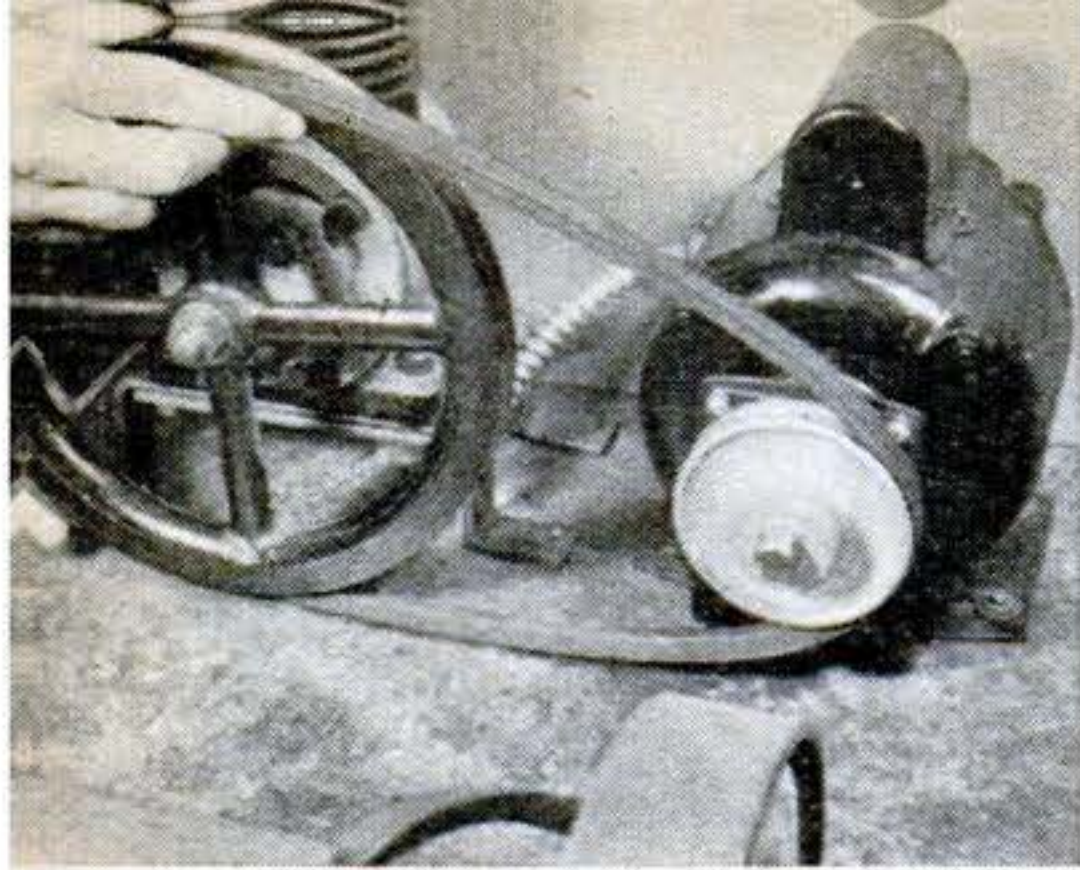

KEEP THAT BELT TIGHT! A loose belt may allow the pulleys to slip, yet hold motor down to its starting-winding speed, resulting in a burned-out motor.

BUBBLE FLUID or soap solution gives you the tip-off on leaky joints, which are usually plentiful in a new system. Just brush it on and watch for bubbles.

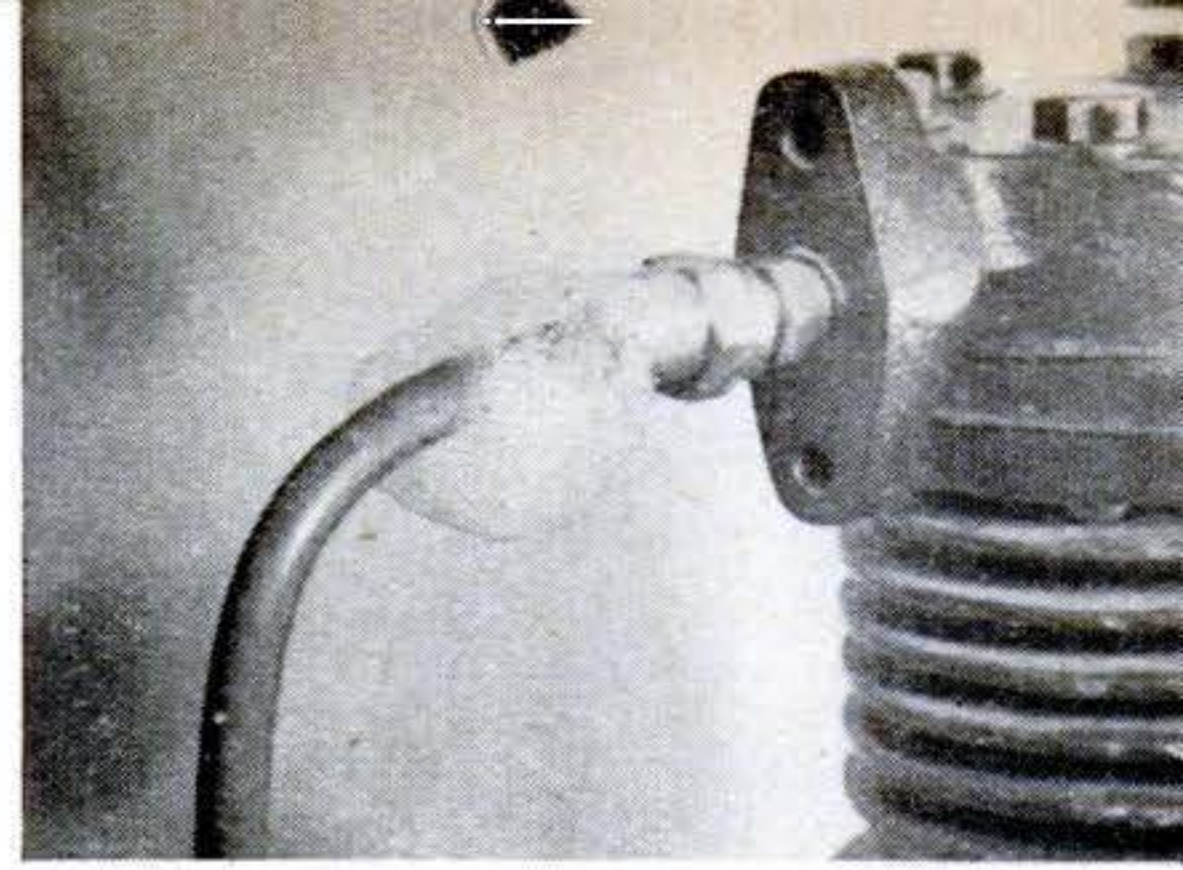

bit of air. It is important to use a pop-off valve to police the pressure switch.

If you don't want the system running when you are not in the shop, connect the motor in parallel with the shop lights. Then the system will swing into action only when you are likely to want air.

A check valve installed between the compressor and tank prevents leakage back through the compressor valves when the motor is off. I find a maximum pressure of 80 lb. is sufficient for most shop needs. The pressure switch is set to maintain this value and the safety valve pops off at 100 lb.

A dust filter should be mounted on the intake opening of the compressor. These may be purchased with a nipple threaded to fit, or you can make one from a small tin can filled with lightly oiled steel wool. Clean it occasionally with gasoline, and re-oil.

Storage tank. Some of the best ones I have seen are the war-surplus, 12" by 24" stainless-steel oxygen tanks, which have threaded outlets at each end. Two of them in series hold plenty. Mount the tanks vertically and include a drain cock on the lower connection to drain off the water that condenses out of the moist cellar air.

An oil and water trap fitted between the

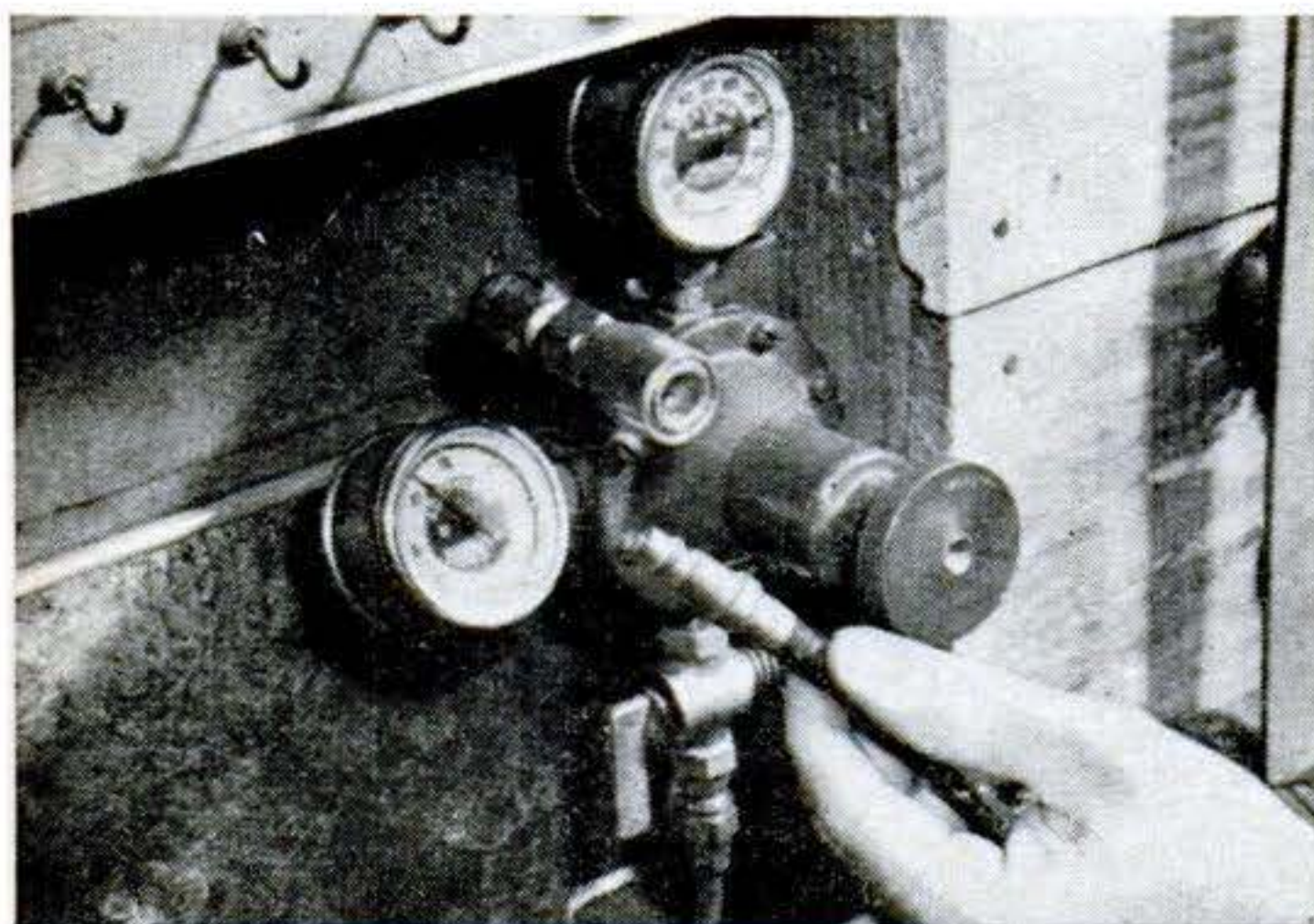

AN OXY-ACETYLENE REGULATOR is a handy accessory. Adjustable, it lets you use air at a lower pressure than that in the storage tank.

compressor and the tank collects the first bits of condensation along with the oil mist thrown up by the piston. Any such contamination is bad for paint spraying.

Spraying, and some other operations, require a much reduced pressure, but a constant flow. For maximum convenience, this calls for a reducing or regulating valve. I picked up a bargain in a used acetylene reducing valve equipped with two gauges: a regulating gauge, which gives good control from 0 to 30 lb., and a capacity gauge, which indicates tank pressure. Valves, tanks and traps are connected with $\frac{1}{4}$ " copper tubing and flare fittings, sold by auto-supply houses.

Hose. Heavy-duty windshield-wiper hose makes fine air line. Be sure you get the type with at least one fabric layer molded inside. For real convenience, fit all hoses with quick-disconnect fittings; see your auto-supply dealer for these. They allow you to snap the hoses together—no screwing up threads. They also have internal valves that close automatically to retain air pressure even though the gun or other tool is disconnected.

Leaks. Do not be surprised if, when all connections have been made, you find plenty of leaks. Search them out by brushing soap suds on every joint. The kids' bubble liquid sold in the dime stores is even better for this purpose. After blowing a roomful of bubbles, I eventually got all my leaks tightened up. Now my system holds pressure for weeks. END

How to Machine Jets' Metals Told

HITHERTO unpublished data are now obtainable on how to machine the high-temperature alloys used in jet engines, the Department of Commerce Office of Technical Services announces. Results of research for the U. S. Air Force are contained in the 161-page *Air Force Machinability Report—1950*. A cloth-bound, illustrated edition is available at \$2.40 from the Curtiss-Wright Corp., Wood-Ridge, N. J.

Homemade Sandblaster Is Handy Finishing Tool

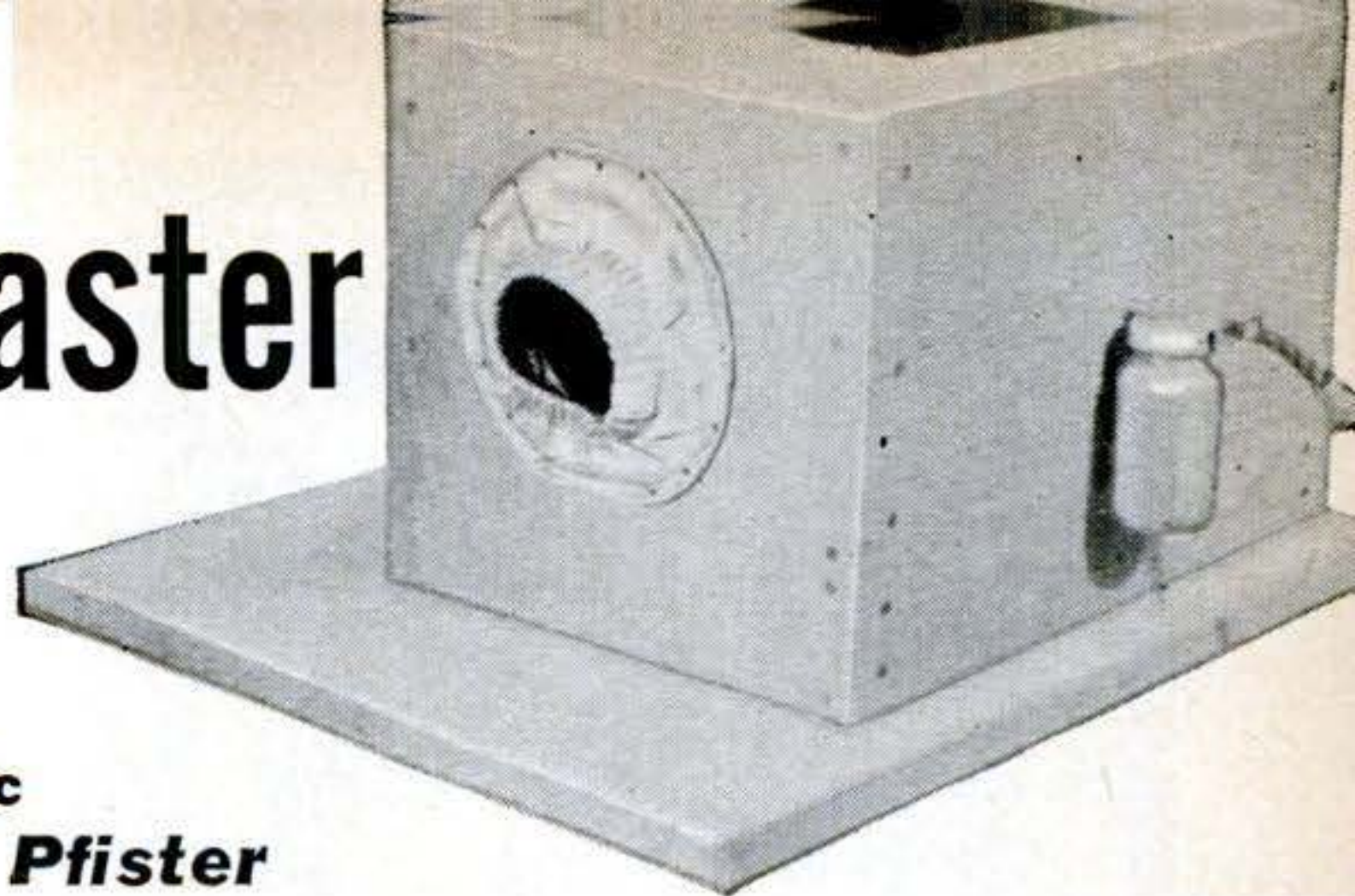

High-velocity jet of beach sand etches plastic and puts satin finish on metal. By Herb Pfister

IN SECONDS a jet of flying sand can finish off the surfaces of such hard-to-polish items as ornate silverware, costume jewelry and irregularly shaped castings. It will clean spark plugs and apply a lustrous satin finish to metal. Frosty designs are quickly etched in plastic when part of the masking paper is cut away. Small brass details in model work look like real sand castings when they're sandblasted.

The sand gun is nothing more than a brass tube soldered to a jar cap. Punch a $\frac{1}{8}$ " hole in the cap to form a tiny funnel and line it up with a $\frac{3}{16}$ " hole drilled in the tube. A length of $\frac{1}{4}$ " brass rod is drilled as shown and soldered into the tube just behind the hole. The projecting end of the drilled rod becomes the nipple for the air hose. Since the sand falls into the airstream beyond the No. 70 hole, the hole won't enlarge in use, as is often the case with commercial sand guns.

The parts for the sandblaster probably can be found around the house. (This is a particularly good time to point out to your wife that the "junk" you've been saving isn't really junk at all. That old coffee-percolator sieve, filled with steel wool, becomes an efficient dust filter, and a sleeve with an elastic cuff seals off the armhole while you're blasting away inside.)

Use $\frac{1}{2}$ " plywood for the box and cement strips of felt around the top edge to prevent dust seepage under the cover. Window glass in the cover lets you see what you're doing.

The sand may be scooped up from the bottom of the box and used over and over again. In time the grains may grow dull and should be changed. I've been using the dry, white beach variety and it has handled every job I've put it to.

Before filling the jar sift the sand through a kitchen strainer. The gun is then inserted in the bushing and inverted, allowing the sand to trickle into the tube. I've been using 40- or 50-lb. pressure. Unless you have strong objections to a satin-finished thumbnail, there's no need to wear a glove. Turn the work constantly in the hand, peering through the glass viewer to keep it in the line of fire. You'll find that the sand stream cuts best three to five inches away from the nozzle. It won't take long to learn how to hold objects on the receiving end of this sand bazooka.

END

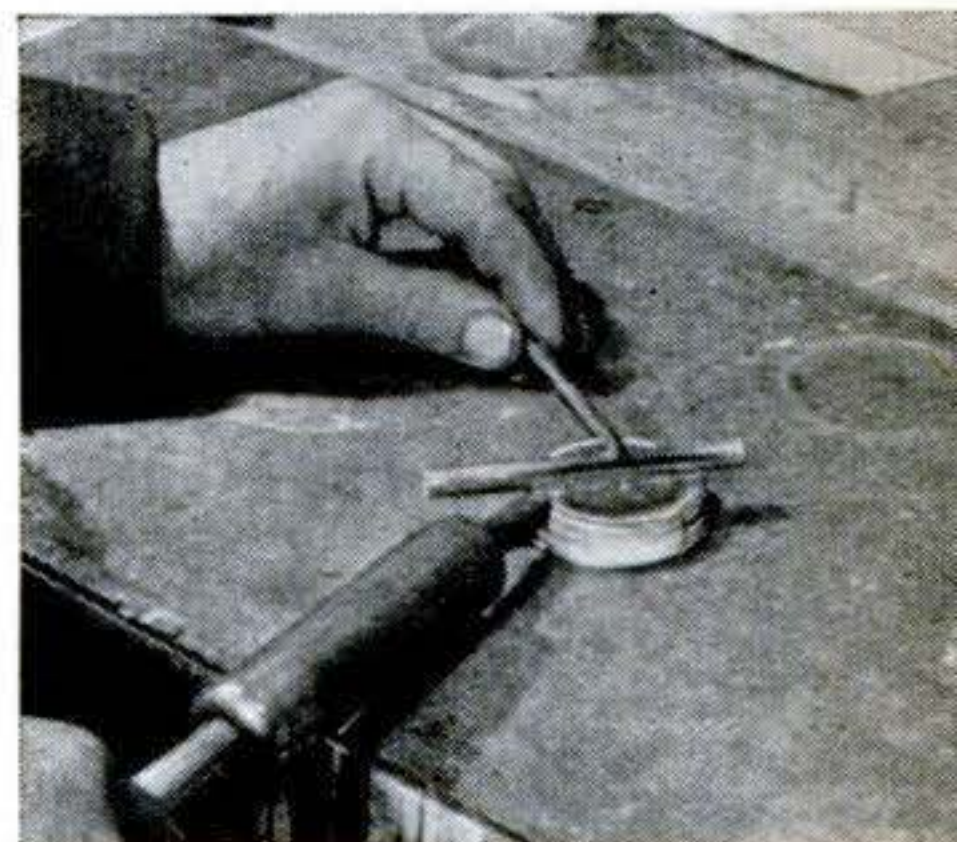

SOLDER tube assembly to cap after aligning punched hole in the cap with drilled hole in the tube.

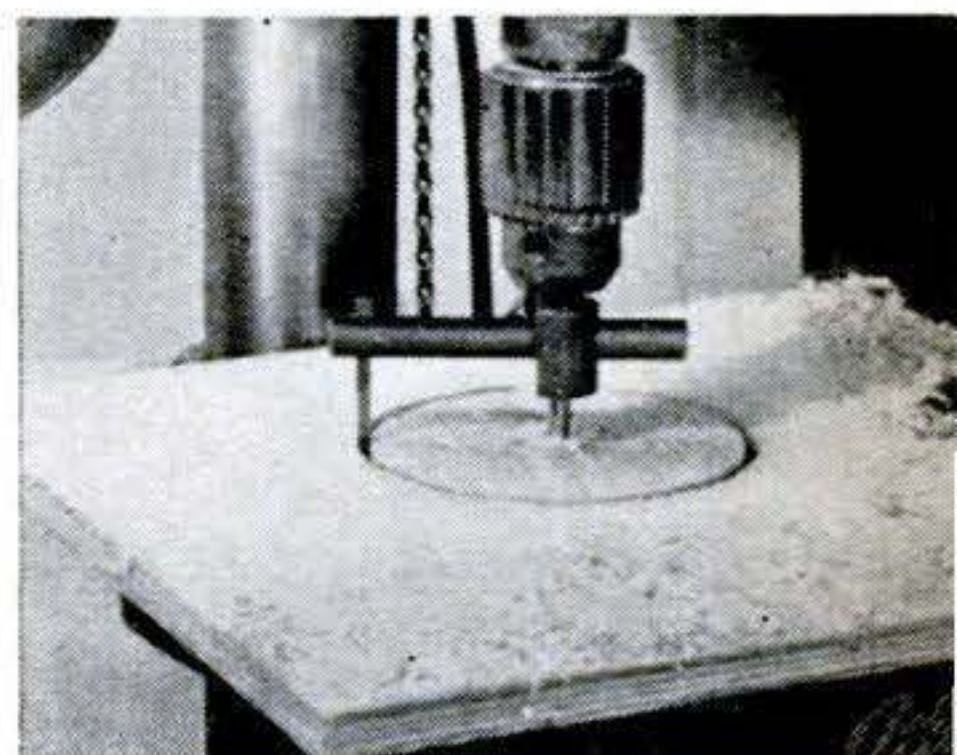

USE an adjustable circle cutter to form armhole and opening for the percolator sieve.

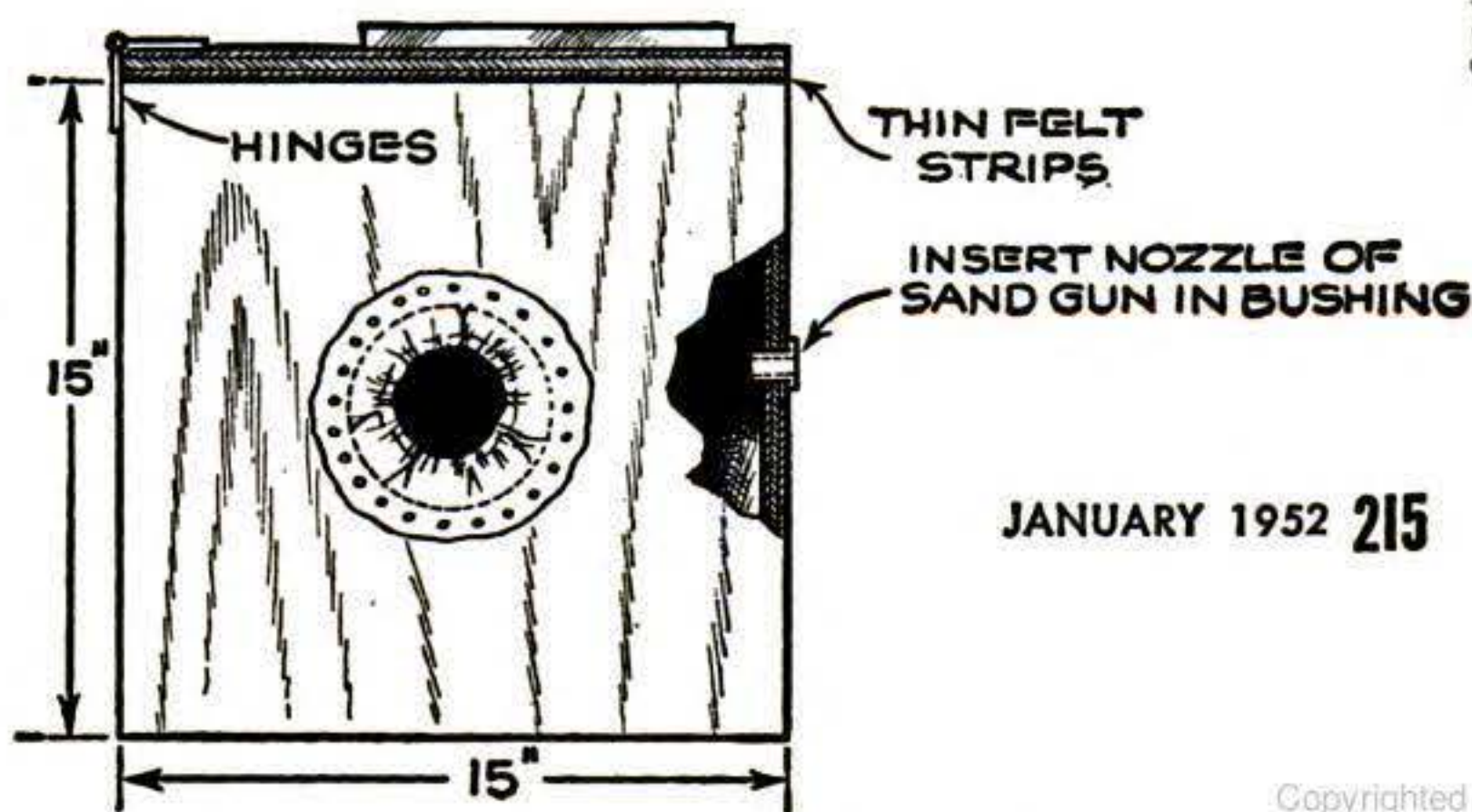
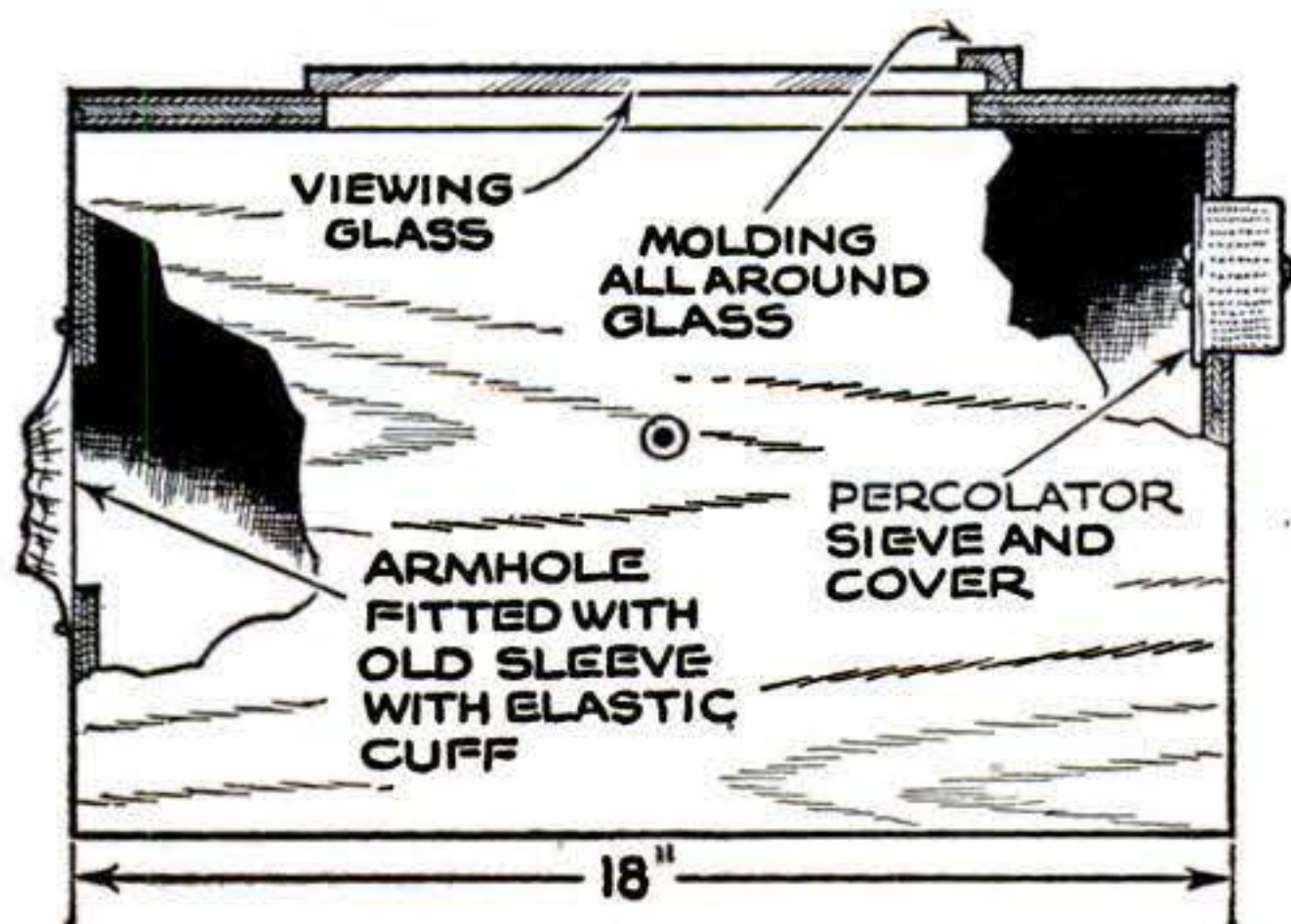
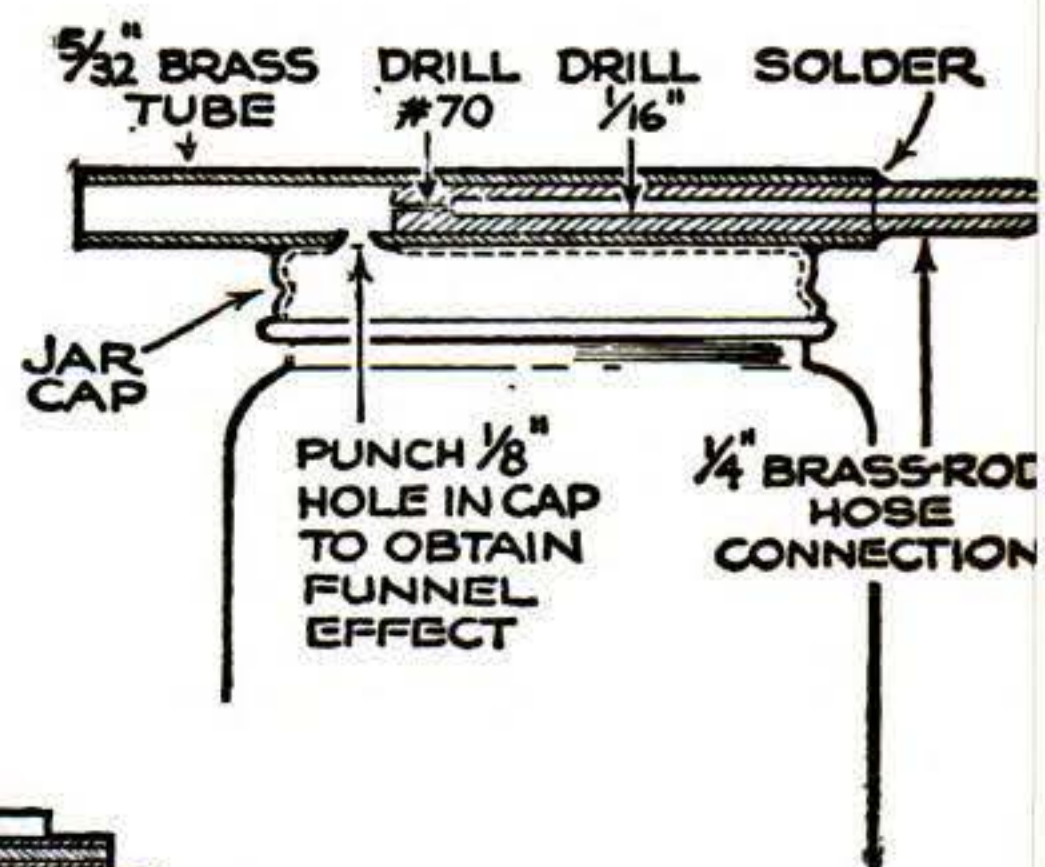

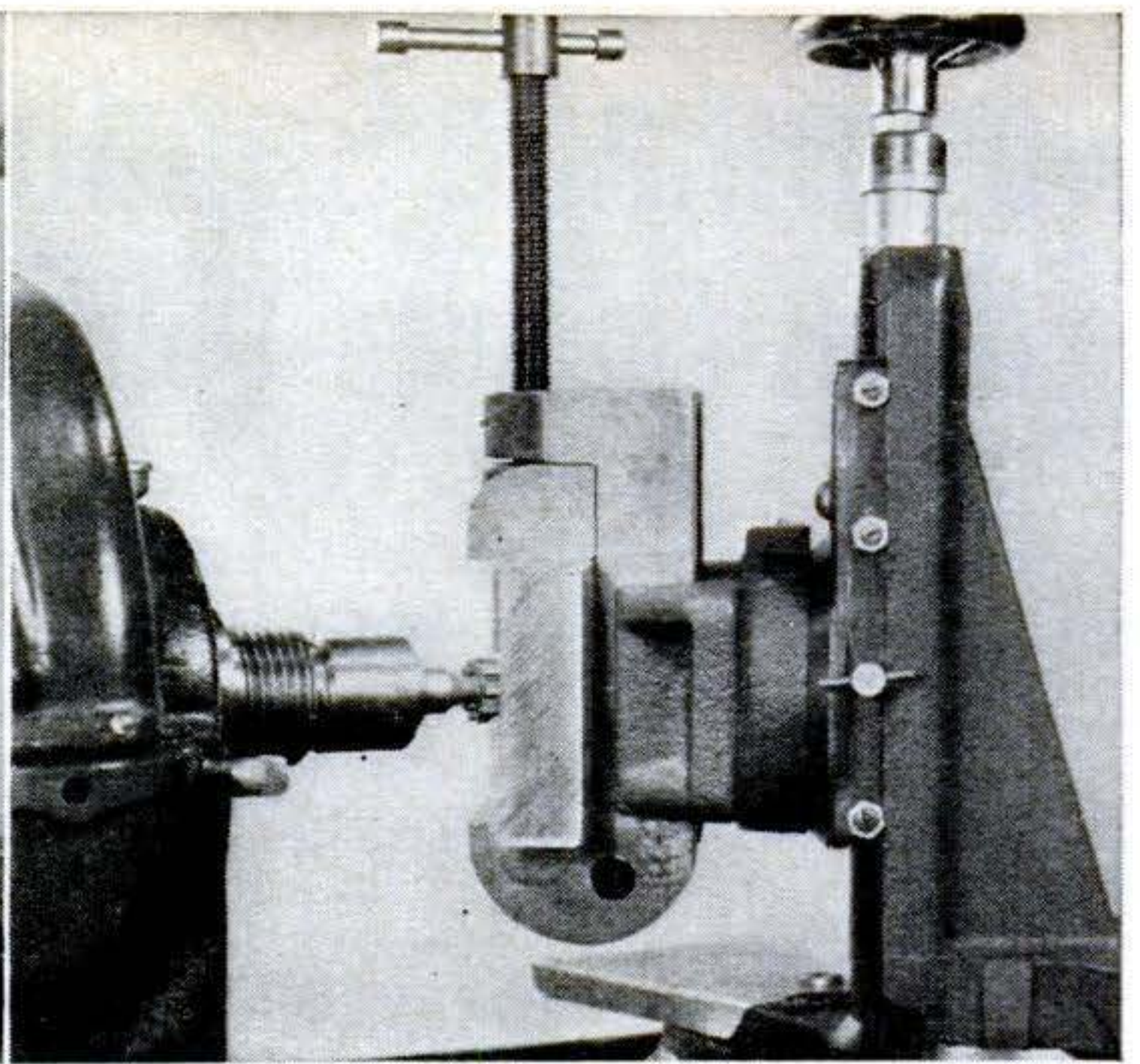

Boost Milling Capacity. Many a job can't be handled in the lathe milling attachment because it won't fit. For example, I had to mill some dural bar $3\frac{1}{4}$ " wide, but the vise jaws opened only to $2\frac{1}{4}$ ".

They would have been weakened excessively if cut back to take this stock. What I did was remove only enough material to clamp in a $2\frac{1}{2}$ "-wide drill-press vise. This in turn I modified to hold the $3\frac{1}{4}$ " stock.

For opening out the attachment jaws, the vise was set square to the ways, with both scales at zero. With all lathe and attach-

ment gibs tightened, $\frac{1}{8}$ " was milled from each clamping face as at the left above.

The two hardened faces of the drill-press vise were removed, the sliding jaw taken out, and $\frac{3}{16}$ " machined off it. Reassembled without the hardened faces, the vise would now take stock up to $3\frac{1}{4}$ ". It was clamped in the milling attachment, and the $3\frac{1}{4}$ " dural bar was held in it for beveling as at the right above.

Although this increases overhang, I can take cuts up to $\frac{1}{4}$ " on aluminum, brass and mild steel.—*H. L. Truchelut, Atlanta, Ga.*

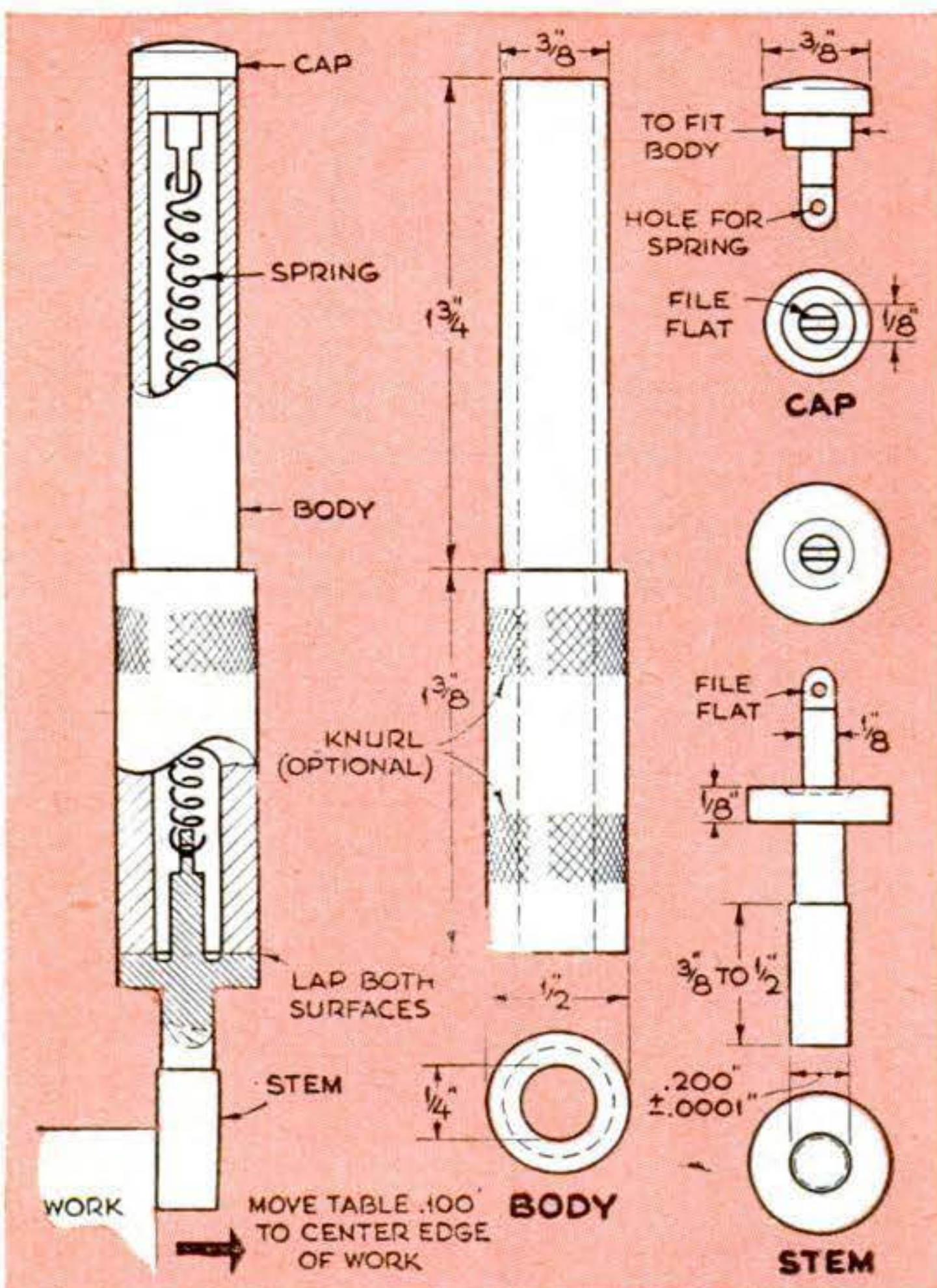

Wiggler for Vertical Use. In my work, I've found this homemade wiggler handier and more accurate than the ball type. Although I use it chiefly on the milling machine and jig borer, it can be used on a lathe or drill press, too. It is held in either a spring or Jacobs chuck, and will work even if the chuck itself doesn't run true.

To use it, tap the stem a bit off center and start the spindle turning. Then move the work up against the revolving stem. You'll see at once when it is running dead true, and it will run off center the moment you go a couple of ten-thousandths past.

The stem is lapped to $.200 \pm .0001$ ". When it runs true, the table need only be moved half that to center the edge of the work under the spindle. Make the tool of drill rod so that it can be hardened all over. After hardening, grind and lap the bottom face of the body. Lap the mating surface of the stem (which is undercut to reduce its bearing area) to the body. The cap may fit freely, as it is held in place by the spring.—*Fred Philips, Queens, N. Y.*

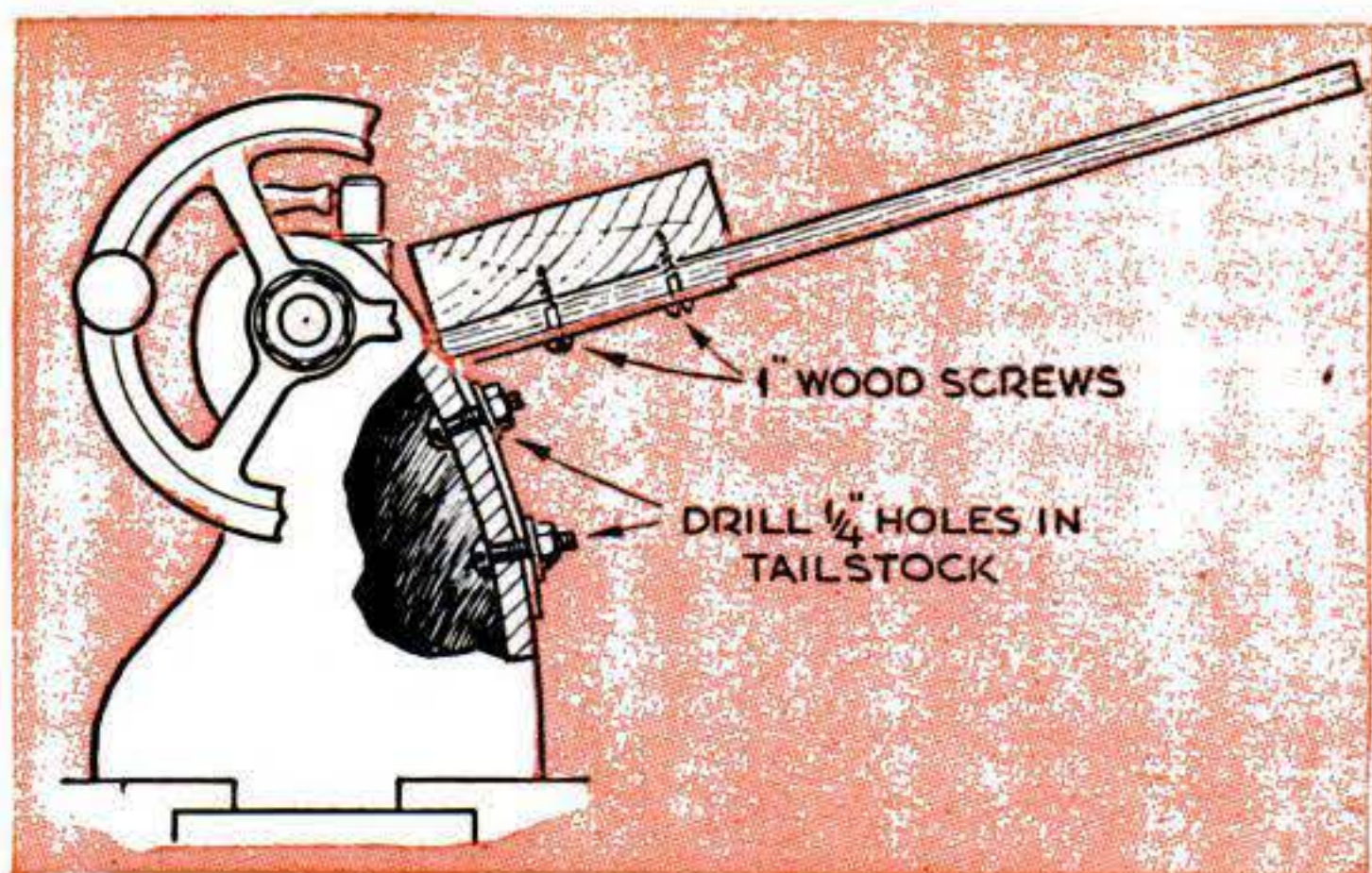

Tailstock Tool Holder. You'll save many a minute at the lathe if you keep tool bits, cutters, chucks, centerdrills and other frequently needed accessories in this tailstock-mounted holder.

It consists of two pieces of wood held on by two metal brackets. Holes are bored in a 7" by 14" panel of 3/8" plywood to receive

Graduating in Degrees. You can mark a quadrant in degrees on the lathe. Clamp it on the compound with a shoe and bolt as shown, adjusting it to swing true on the compound center.

Chuck a boring bar with a sharp V tool set to cut a line on the work (block up the latter if necessary). Lock the carriage with the tool aligned on the compound index mark. Lock the compound and advance the work into the rotating cutter. Line length can be gauged on the feed collar. Reset the compound as necessary for the divisions wanted.—*Bernard J. Corey, Thorold, Ontario.*

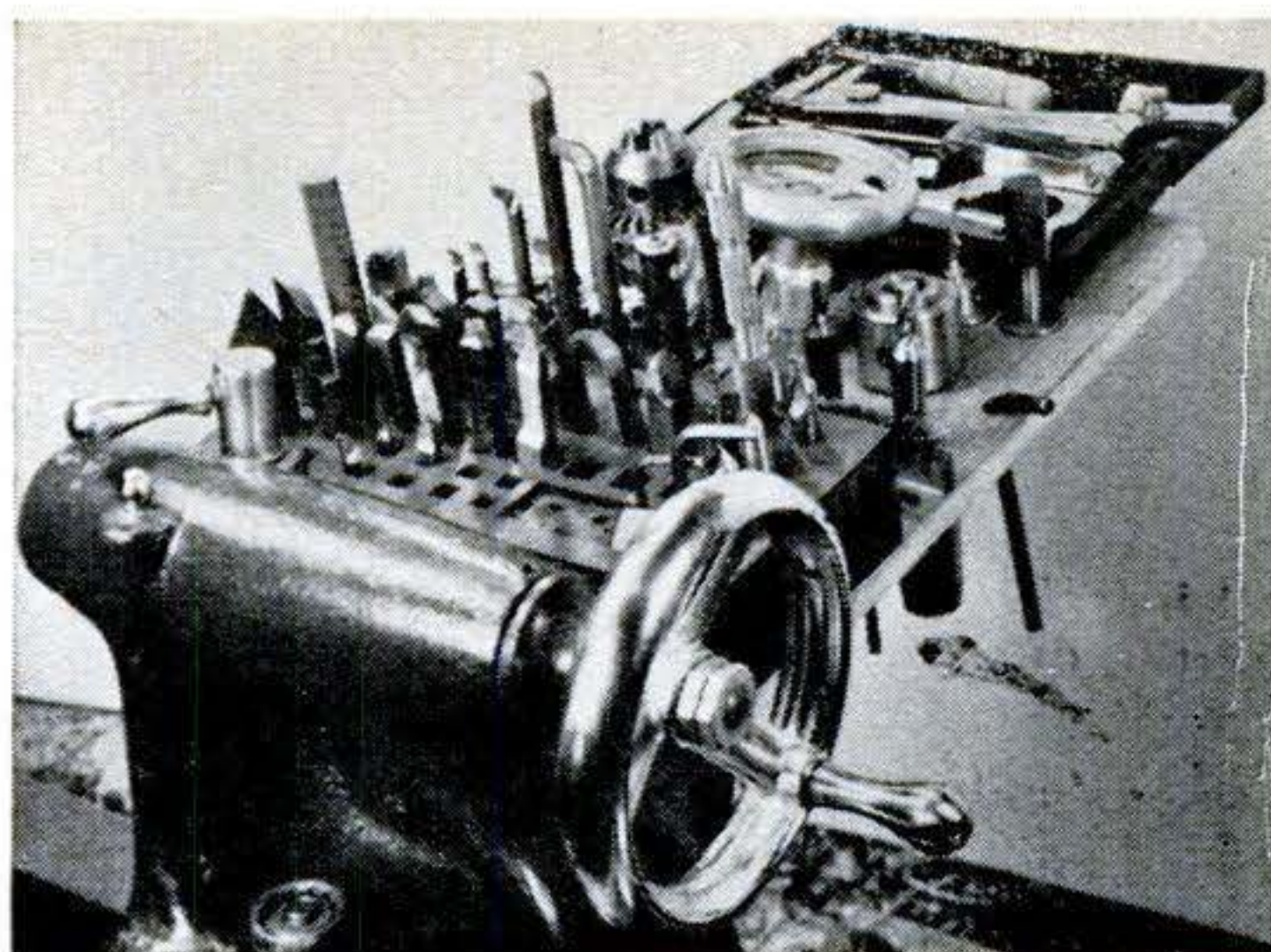

large items that have a shoulder or flange to keep them from slipping through the board. A 1 1/2" by 4" by 7" block fastened to the inboard end of the panel is bored to hold bits, boring bars, centerdrills and other small tools.

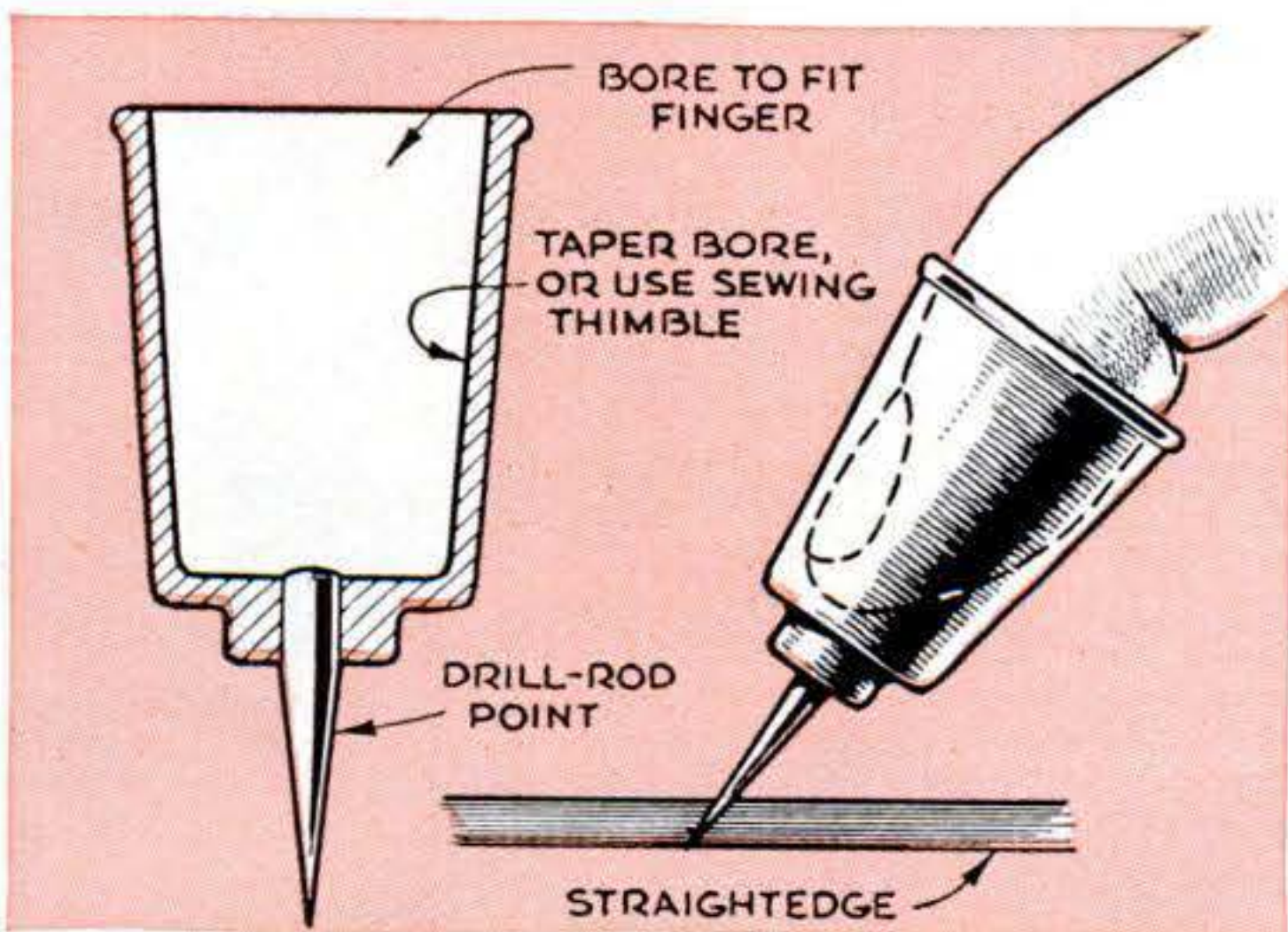
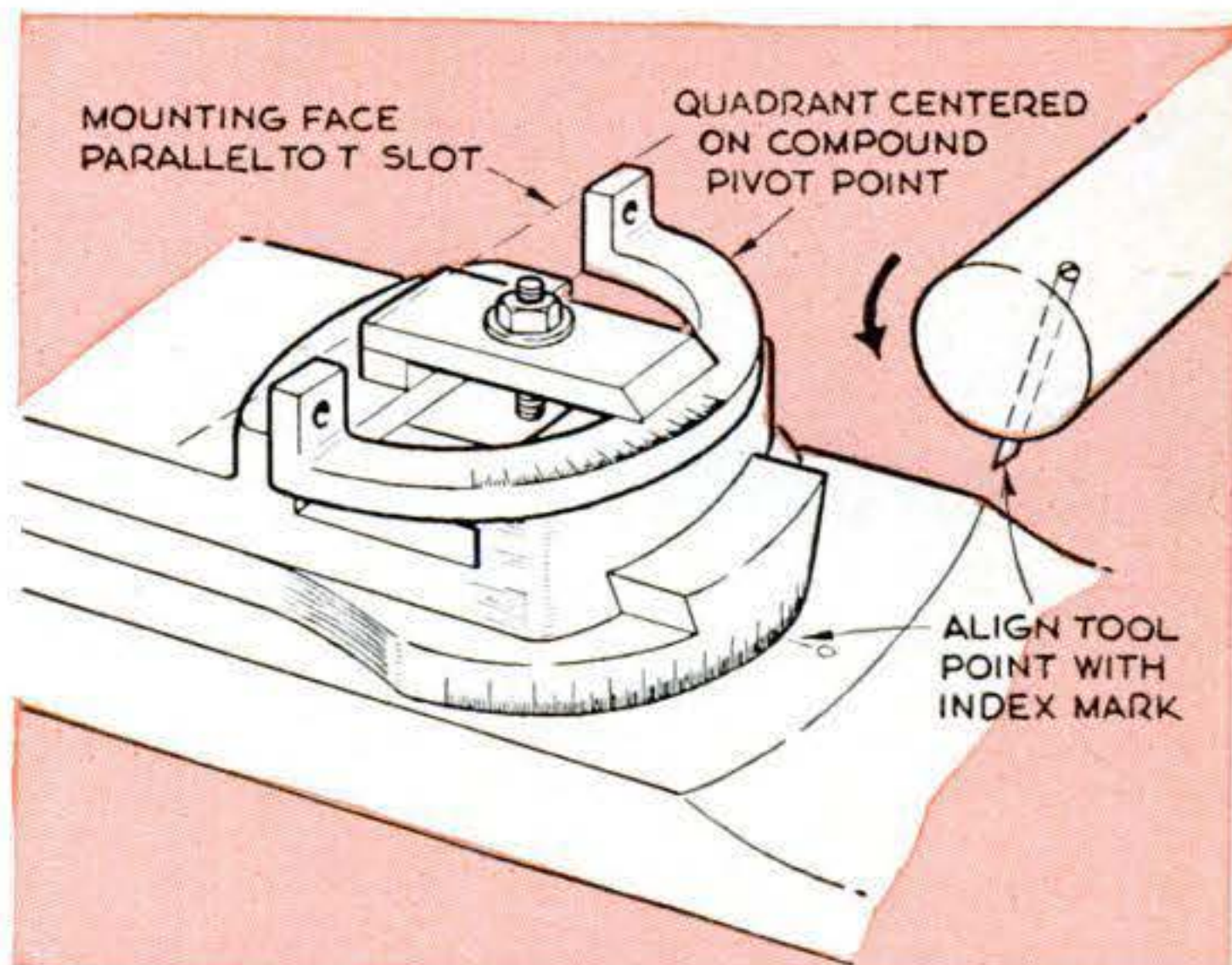

Thimble Scriber. When a scriber is in constant use, wearing it on a finger gives your hands more freedom. Make the thimble of brass and the point from drill rod or a hardened dowel pin. You can also silver-solder the point to an ordinary sewing thimble.—*Jose Sobkowiak, Jackson, Mich.*

Drilling at an Angle. Where precision isn't called for, a simple wooden jig does this hard job the easy way.

Cut a piece of 2" wood at the drilling angle required, and bore a hole at 90° to the cut to hold the work. (In the photo, 45° holes are being drilled in a pipe cap. This was threaded onto a nipple set in the hole.)

Screw the block to a wooden base. Clamp this in the drill-press vise or to the table, centering the punch mark under the drill. Rotate the work for each hole.—*W. Haase, Hartford, Conn.*

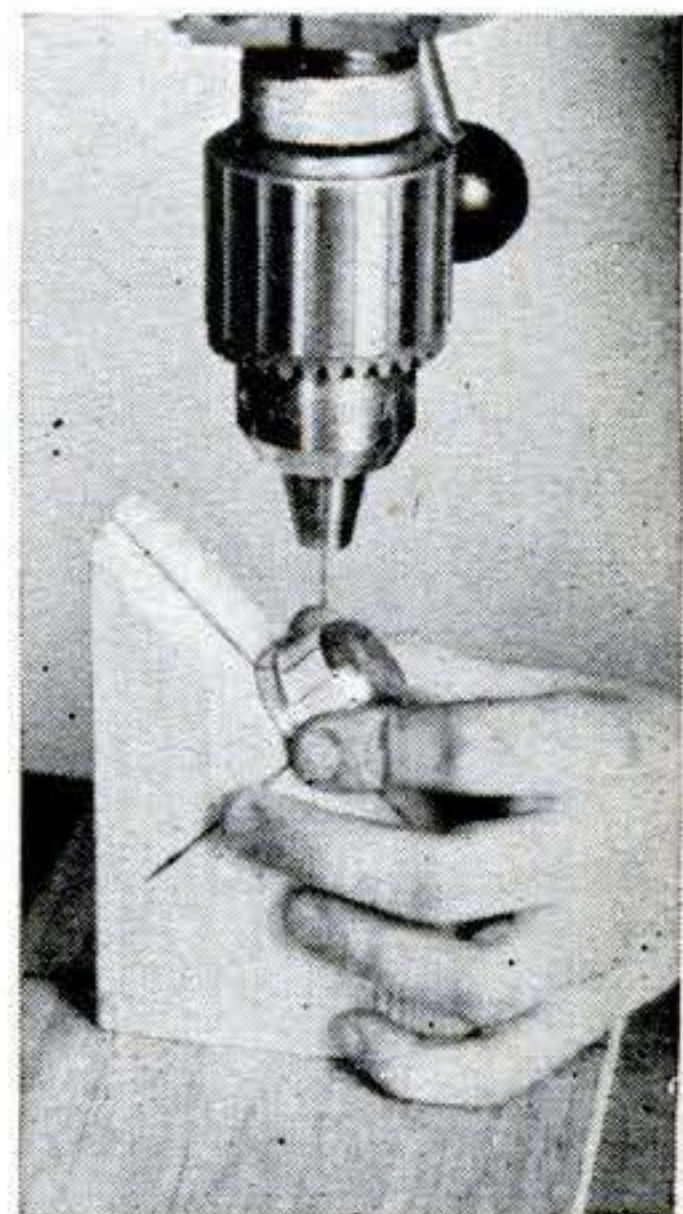

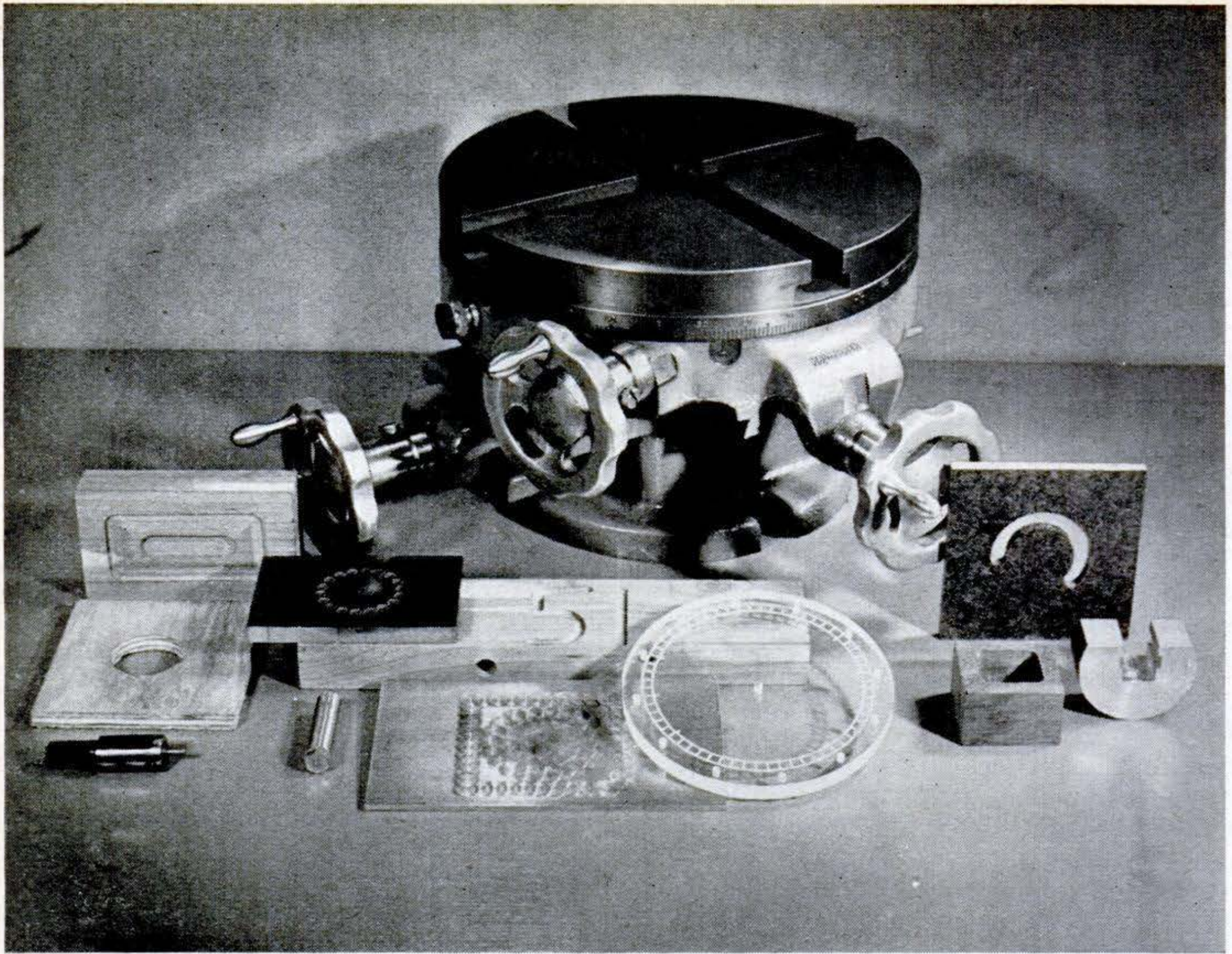

DE LUXE MILLING TABLE and some work it does: panel formed on wood, hole in a lens board, punch with ground flats, hex end formed on brass rod, panel for rotary switch, numeral engraved in wood, engine finish on alumi-

num, clock face of plastic, hollowed-out walnut block for ring box, slotted aluminum piece and curved slot in pressed-composition panel. Setups for most of these jobs are shown in accompanying photos.

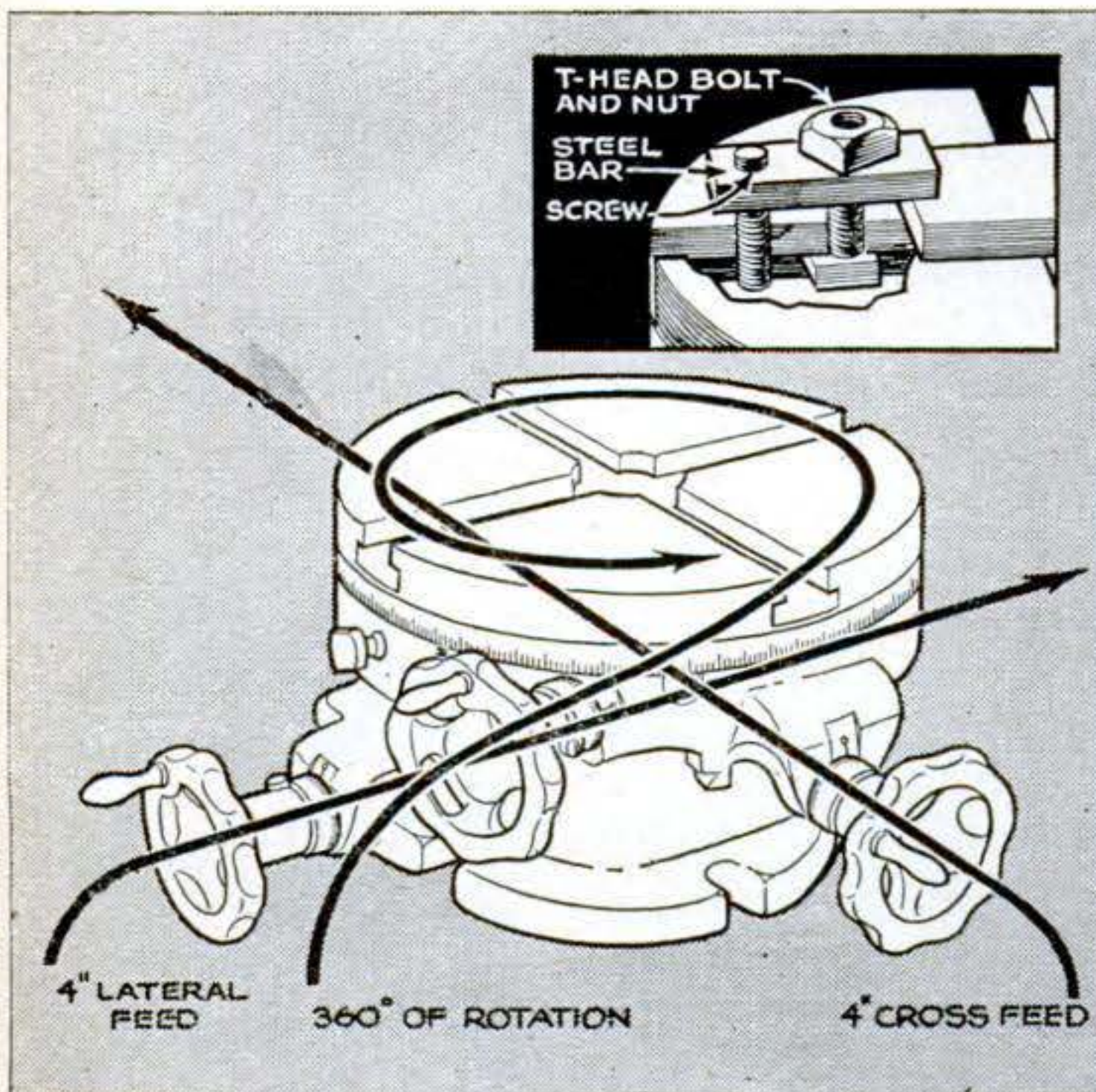

THREE DIFFERENT FEEDS, indicated by the arrows, are provided in this milling table. Insert shows a hold-down clamp made from a length of steel bar, bolt to fit T slot in table, and stud threaded for screwdriver adjustment.

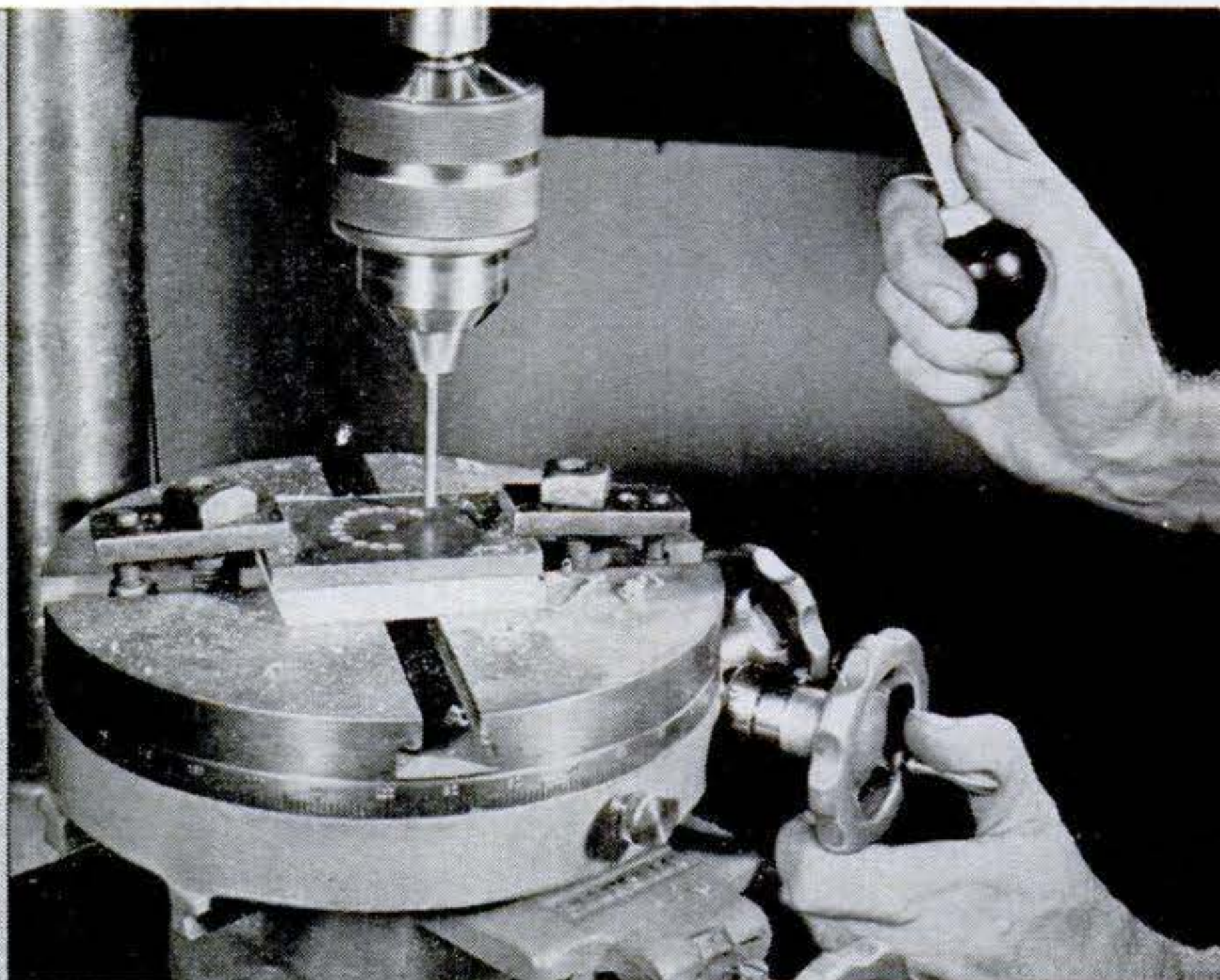

A ROTARY FEED speeds drilling circular rows of precisely spaced holes. The holes being drilled here are to hold the points of an experimental rotary switch. Same job can be done on two-feed table by indexing table.

Milling in Your Drill Press

With accessory table and cutters you can turn out tricky jobs that you couldn't tackle any other way.

By Walter E. Burton

IF YOU would like to own a milling machine but can't spare the dough, a milling table mounted on a good drill press often makes a satisfactory substitute.

The de luxe job shown here is equipped with two cross-feeds at right angles to each other, plus a rotary feed. The table thus can be rotated on its axis and moved in two directions. Micrometer collars on the cross-feed handwheels indicate table travel in thousandths of an inch. A scale around the circumference of the table shows rotary movement in degrees.

A less expensive model has the two cross-feeds but no rotary feed. Fixed rotary settings may be made by loosening two setscrews on the table base and turning it by hand. It has a degree scale around the hub.

Installation of the milling table is a jiffy job; you just bolt it to the drill-press table and you're all set. Work is mounted

on the milling table with T bolts and hold-downs. These T-head bolts will also tie down a drill-press vise.

Depth of cut is controlled by setting and locking the drill-press spindle. If there is play or looseness in the spindle, you'd better forget the whole deal, at least until you take up the play or rebush the drill press. Accurate milling just cannot be done when the cutting tool is jumping all over the work.

Spindle speed should be suited to the cutting tool and the material; generally, you will want to use low speeds in milling metal, and high speeds in routing wood.

The drill-press chuck, or preferably the safer setscrew chuck, holds such cutting tools as twist drills, wood-boring bits, routers, milling cutters, slitting saws, grinding wheels and sanding drums or disks. In any operation involving side thrust on the tool, use a positively attached chuck, not one mounted by taper alone. A loose drill-press chuck can be a lethal weapon that will raise your hair if it doesn't part it.

Please turn the page for nine more milling-table setups.

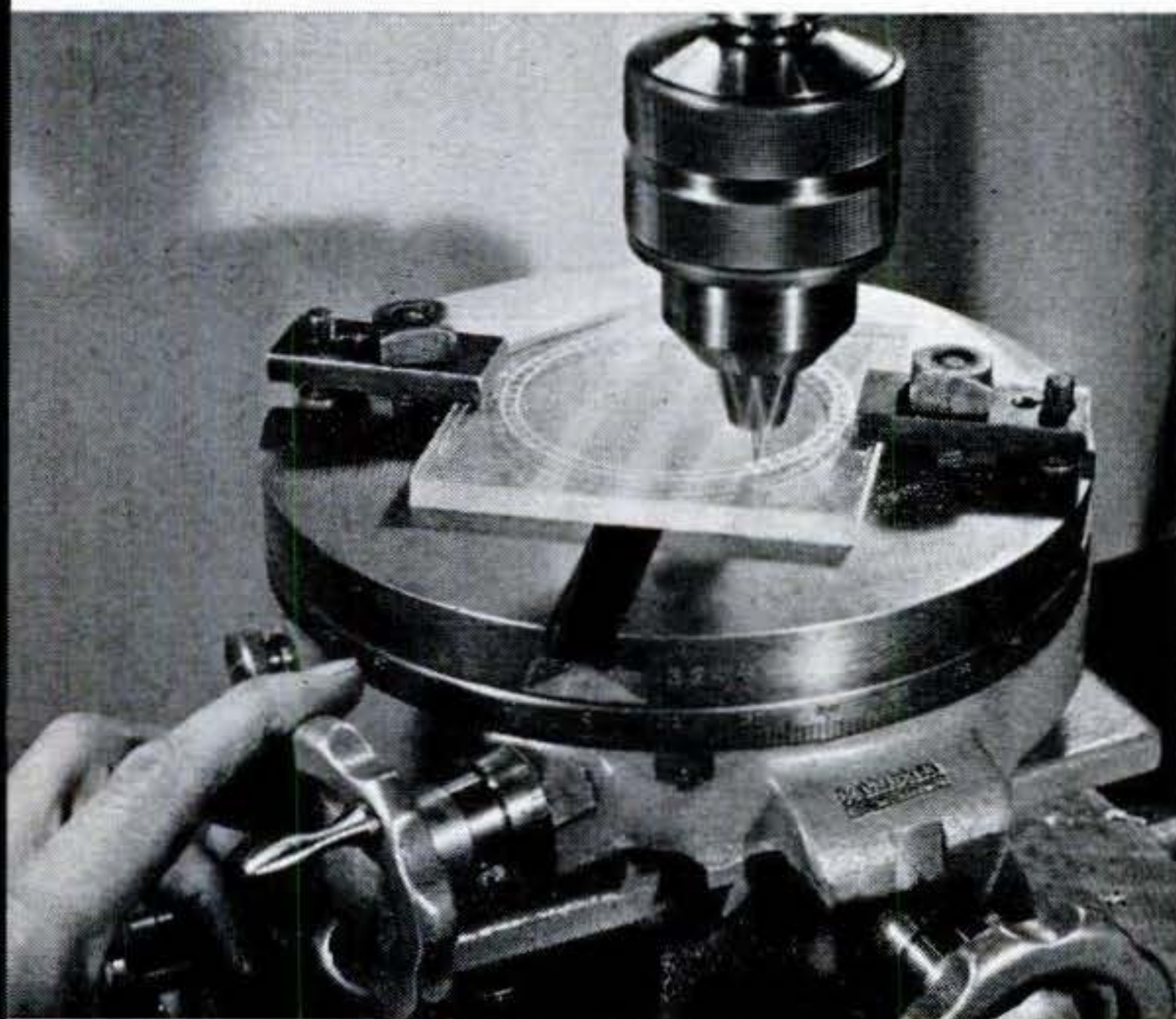

ENGRAVING A CLOCK DIAL on a plastic sheet is a simple job. The engraving tool used was a discarded dental ball bit, operated at fairly high speed. Rotary movement forms rings, cross movement the minute marks.

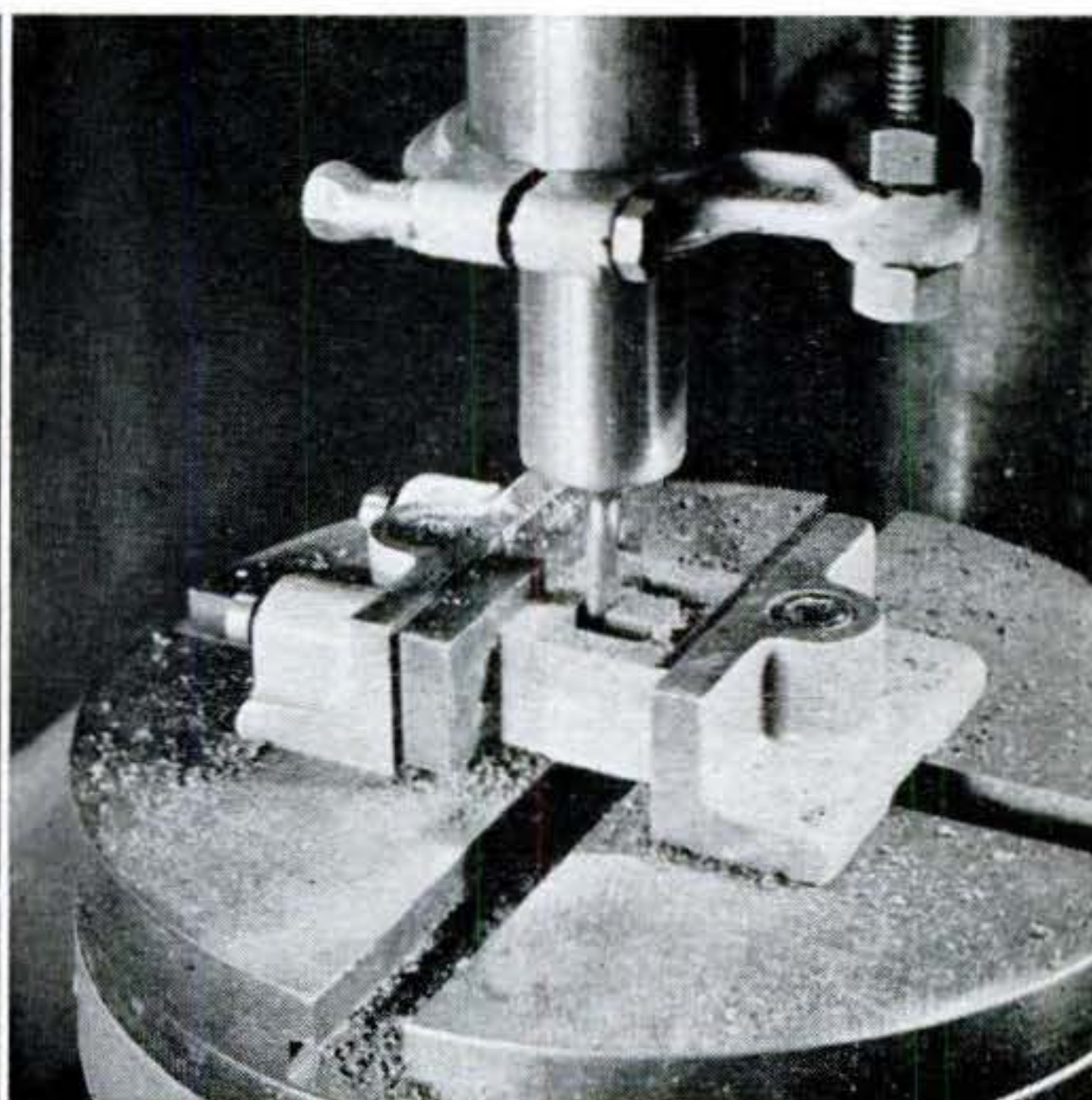

A HARDWOOD BLOCK being hollowed with a $\frac{1}{4}$ " wood-routing bit to form a ring box. To hold such work, a special vise may be purchased to fit the T slots in the table. Jaws can be locked anywhere along the table slots.

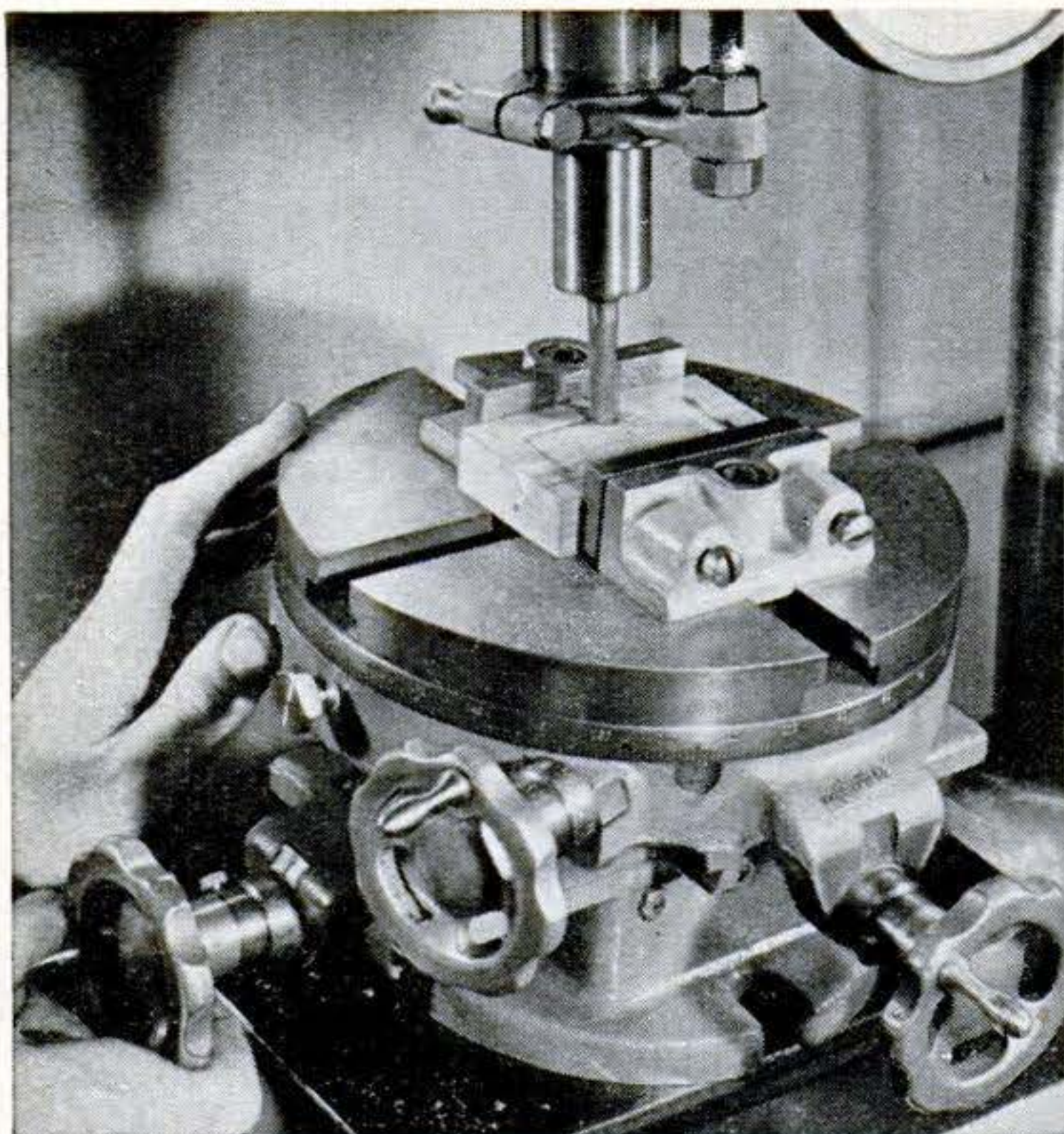

ROUTING PANEL IN WOOD. The drill press table is tilted to the desired angle for the panel edge. Because of this angle, the table must be rotated after each cut so all cuts are made in the same direction.

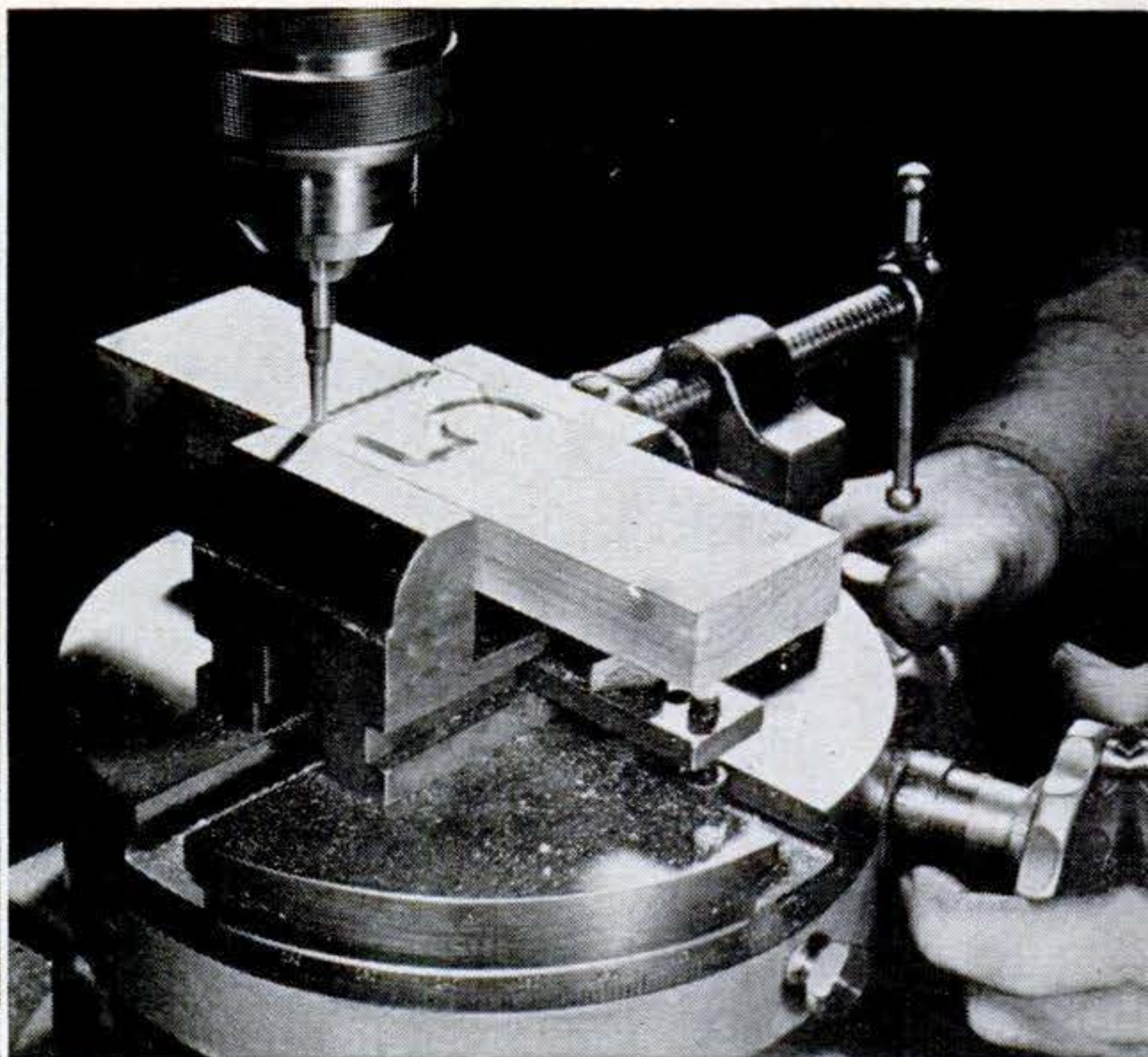

ROTARY AND CROSS-FEED MOVEMENTS of the table permit neat letters and figures to be engraved in wood, plastic or metal. A router bit designed for engraving should be used. Test cuts are advisable.

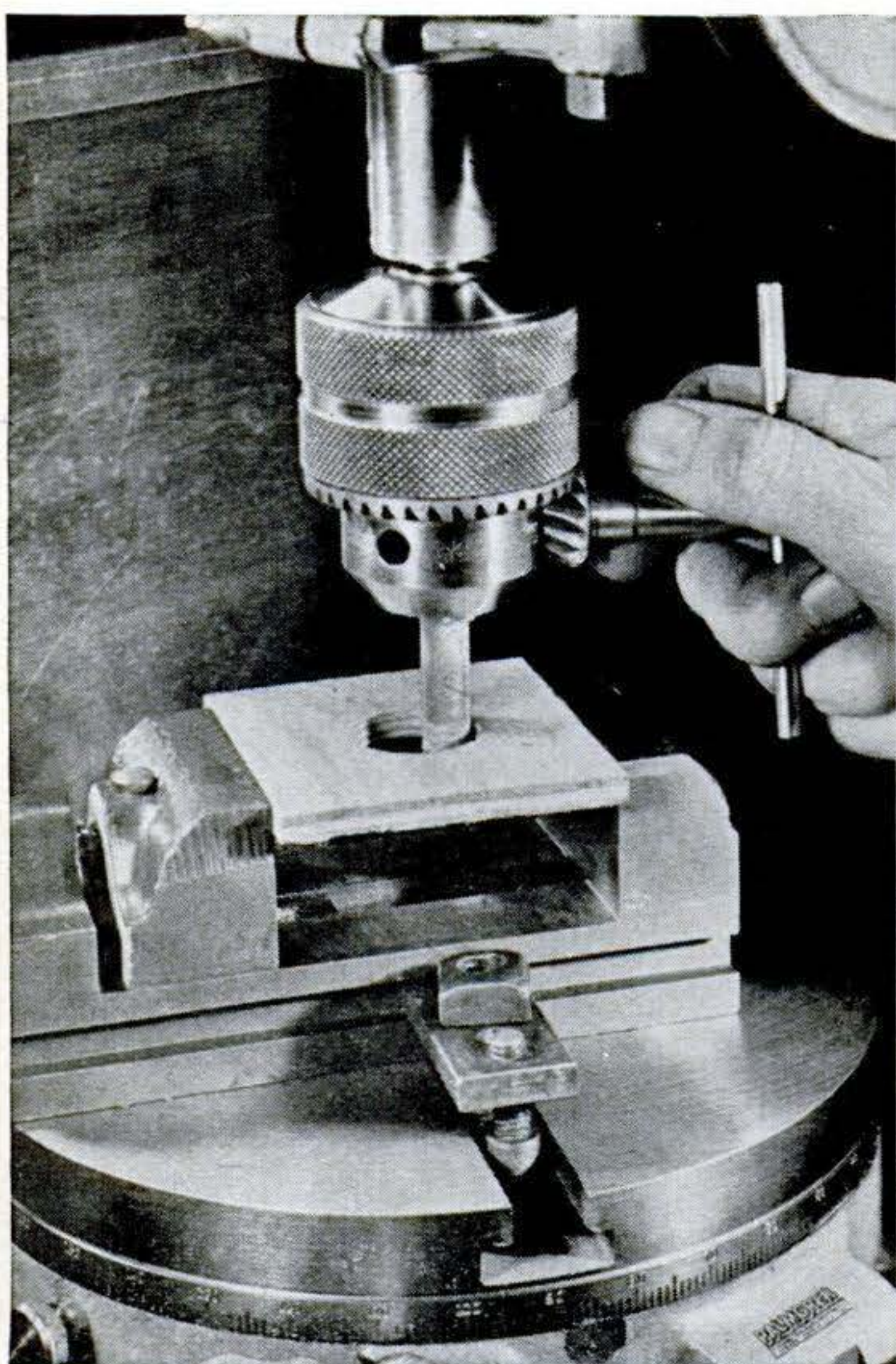

USING ROTARY FEED, a hole in a lens board is sanded with a small spindle. Unless hole was bored at same setup, be careful to locate it over the center of rotary table.

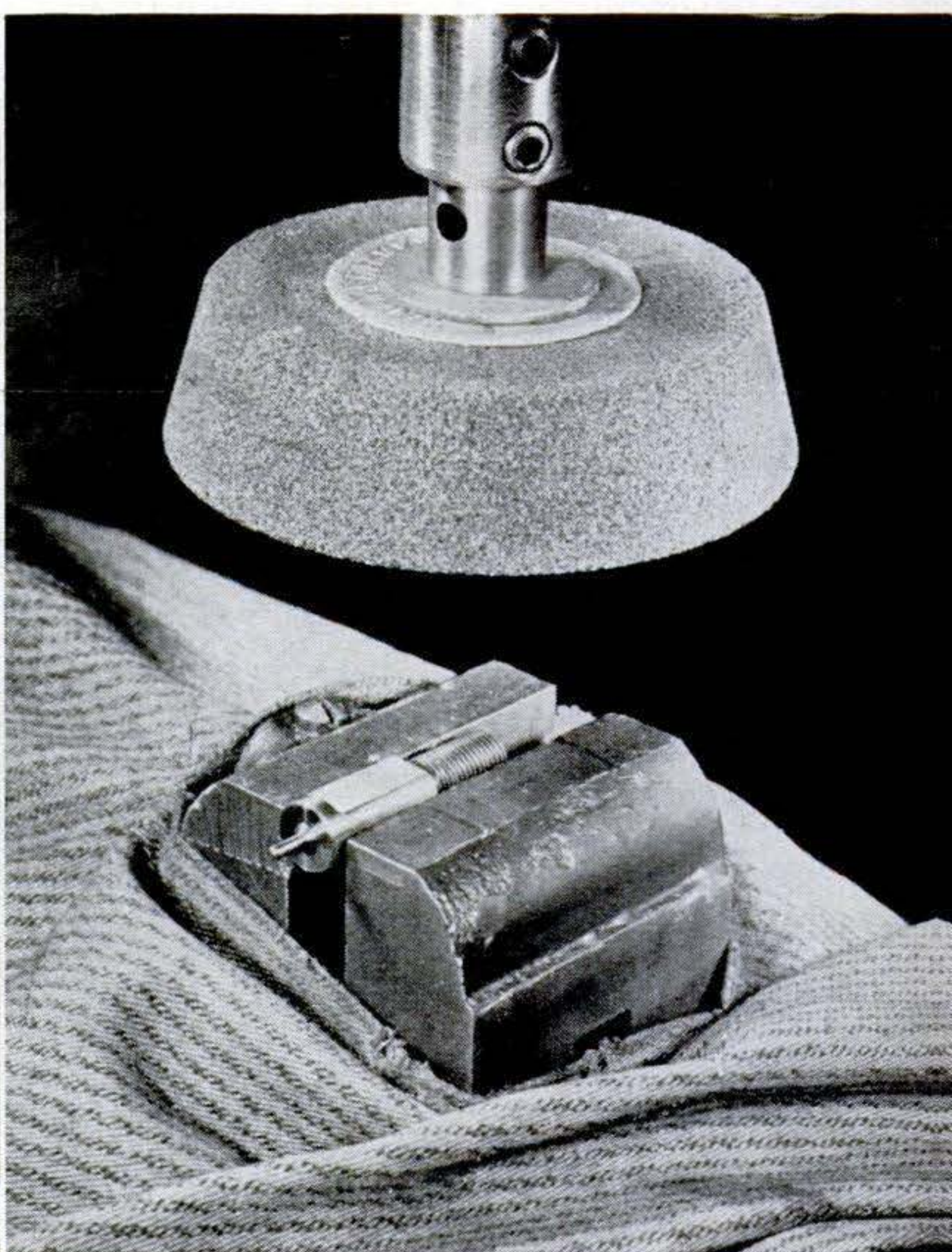

GRINDING WHEELS of various shapes mounted in the safety spindle chuck convert the milling table into a precision grinder. A cloth protects the table from grit.

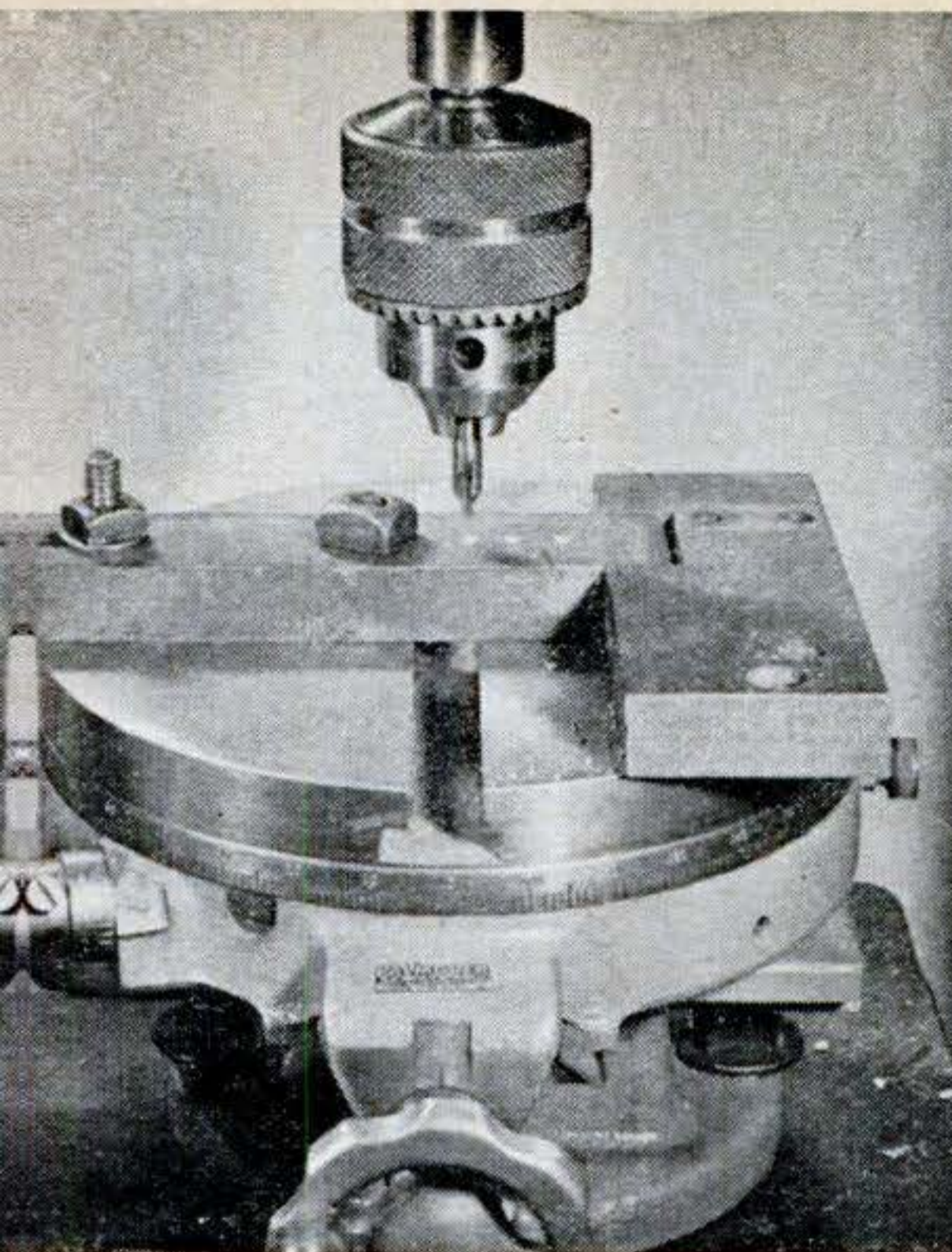

CALIBRATED FEED SCREWS make it possible to position holes to close tolerances. Start the holes with a center-drill, follow with twist drill.

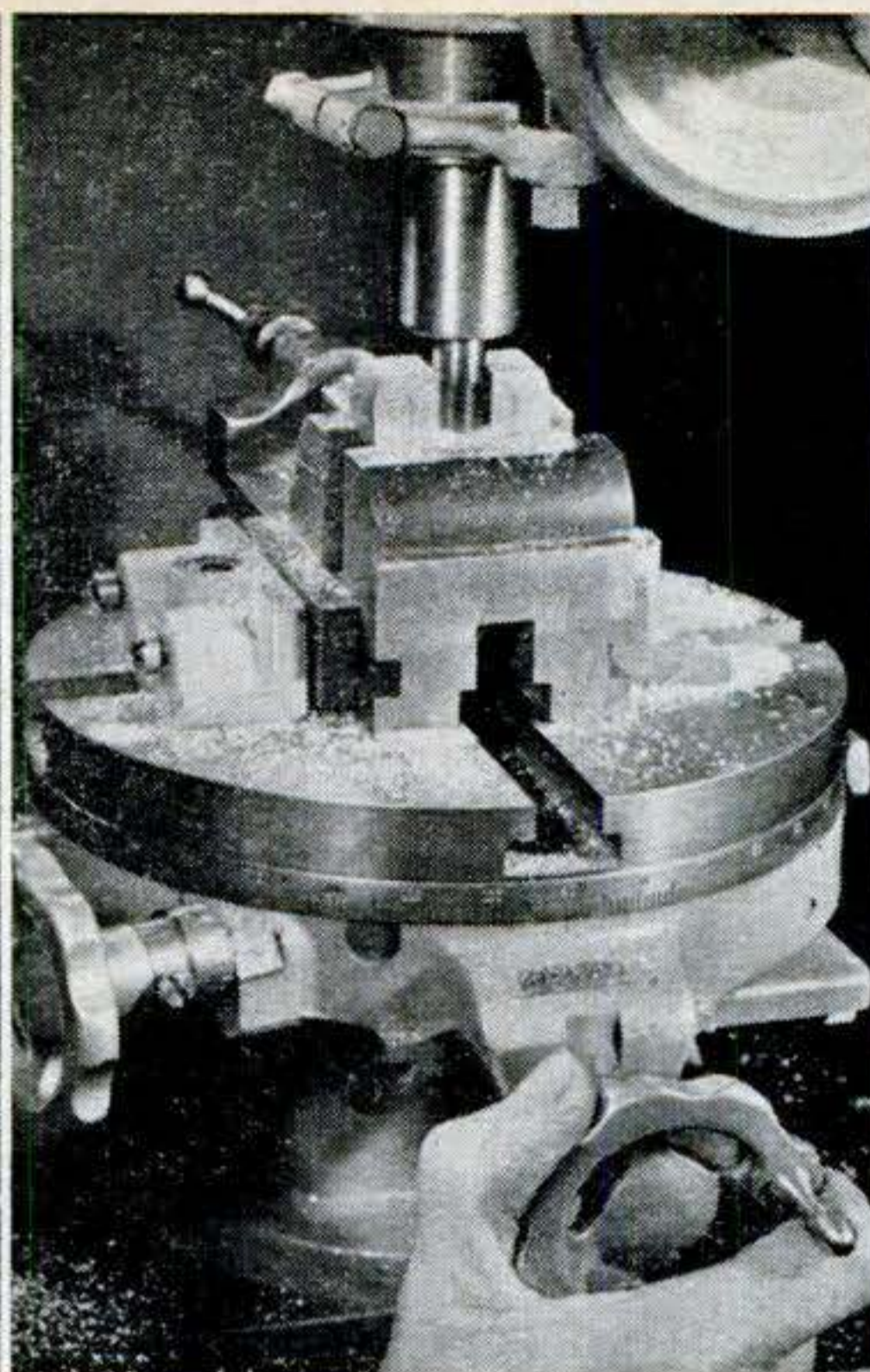

END MILLING a $\frac{1}{2}$ " slot in aluminum. Keyways are similarly cut in shaft ends. Cross-feed of milling table is used to move work.



SLITTING SAW mounted on arbor is useful for making split rings and bushings or slotting screwheads. Slits in collet chucks are easily cut.

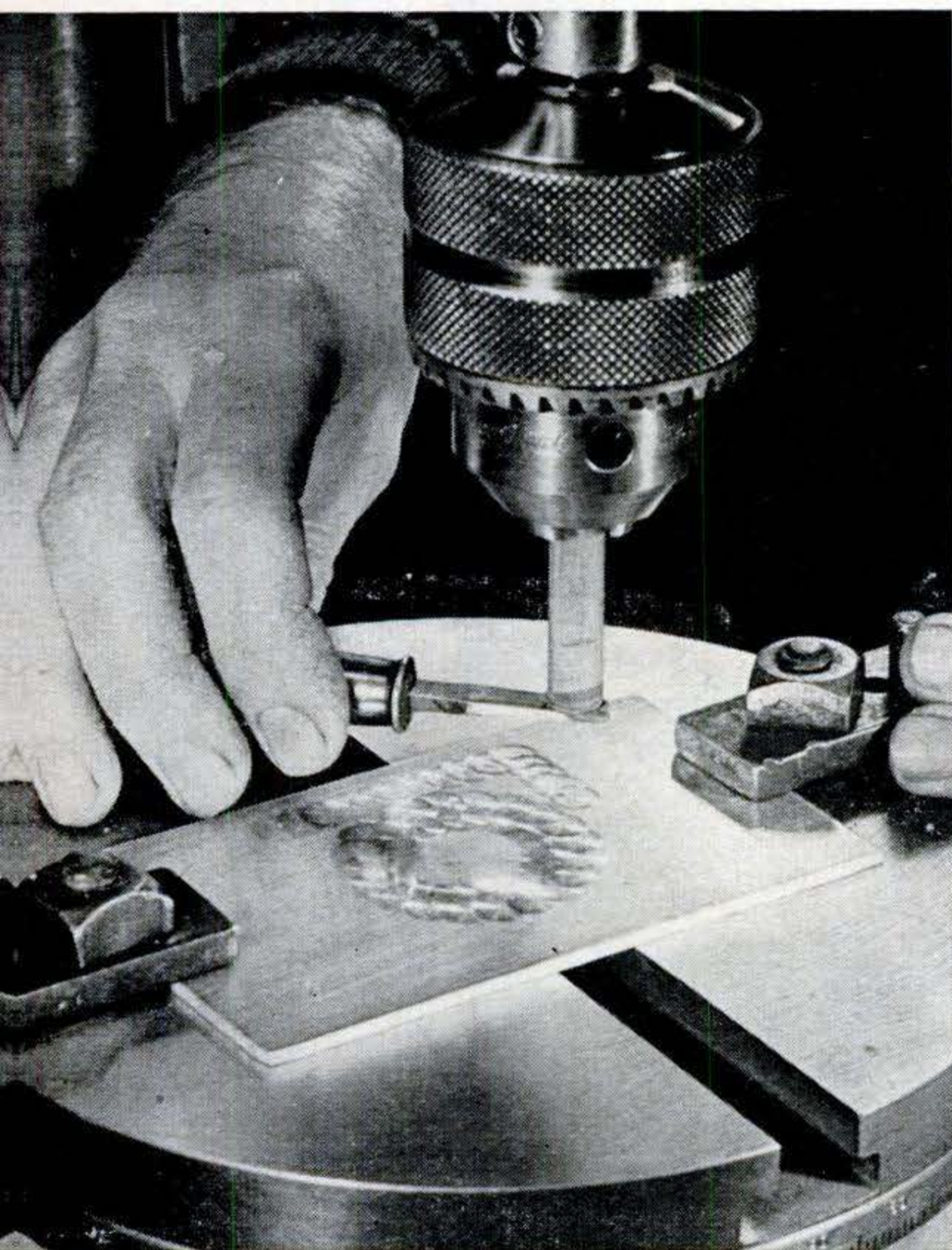

SURFACE FINISHING of type known as spot polish or engine finish can be applied to work with a felt-tipped rod charged with fine abrasive, such as valve-grinding compound.

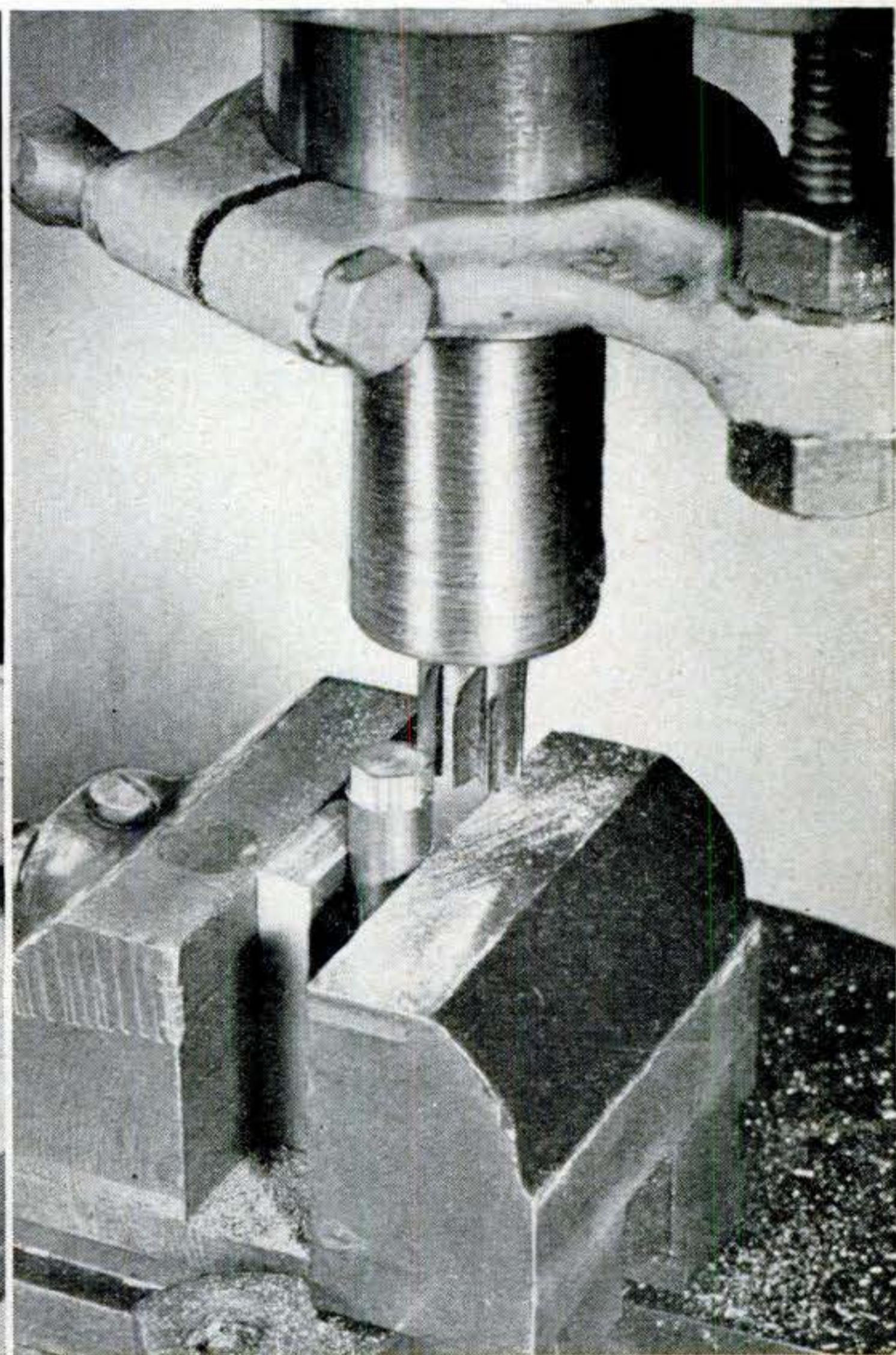

ENDS OF SHORT RODS, studs and bolts may be milled to a square, hexagonal, octagonal or other shape. The work must be centered over the axis of table or head will be offset. **END**

How to Round Corners

CORNER SHELVES were streamlined and modernized by rounding corners. Shelves are solid stock.

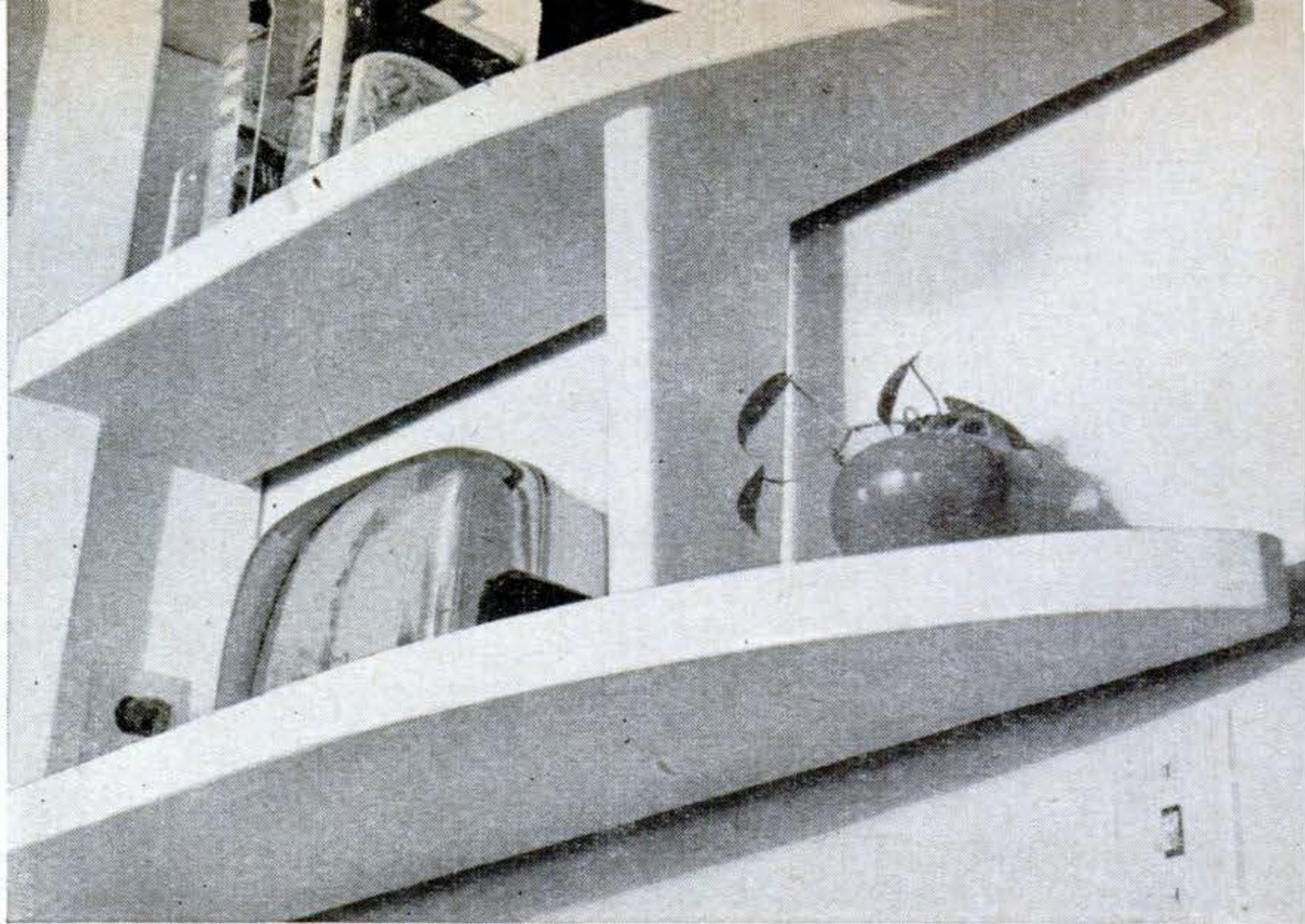

By Robert Hoppough

TODAY'S trend in furniture and cabinetry is toward smooth, flowing lines. Many of these effects are achieved by steaming large panels and bending them under



DISK SANDER speeds work. Corner was rough-sawed to shape, then rounded on sander.

pressure—a process far removed from the home workshop. But even in small shops much can be done to turn out modern pieces with plenty of eye appeal.

Simple units like the corner shelf above are relatively easy to round off. You just cut them to rough shape and finish off with a plane, rasp and sander.

Guard against splits. A little extra care must be taken when planing end grain. The plane must be worked from the edges to the center, rather than straight across the board end, as there is danger of splitting off a chip at the edge. Glue will repair minor accidents.

Rounding long pieces. Here the main problem is uniformity. You can use a disk-sanding attachment in an electric drill for the roughing, but more uniform results are achieved by using the progressive method shown below.

The corner is first planed or sawed to about a 45° angle. Further planing re-

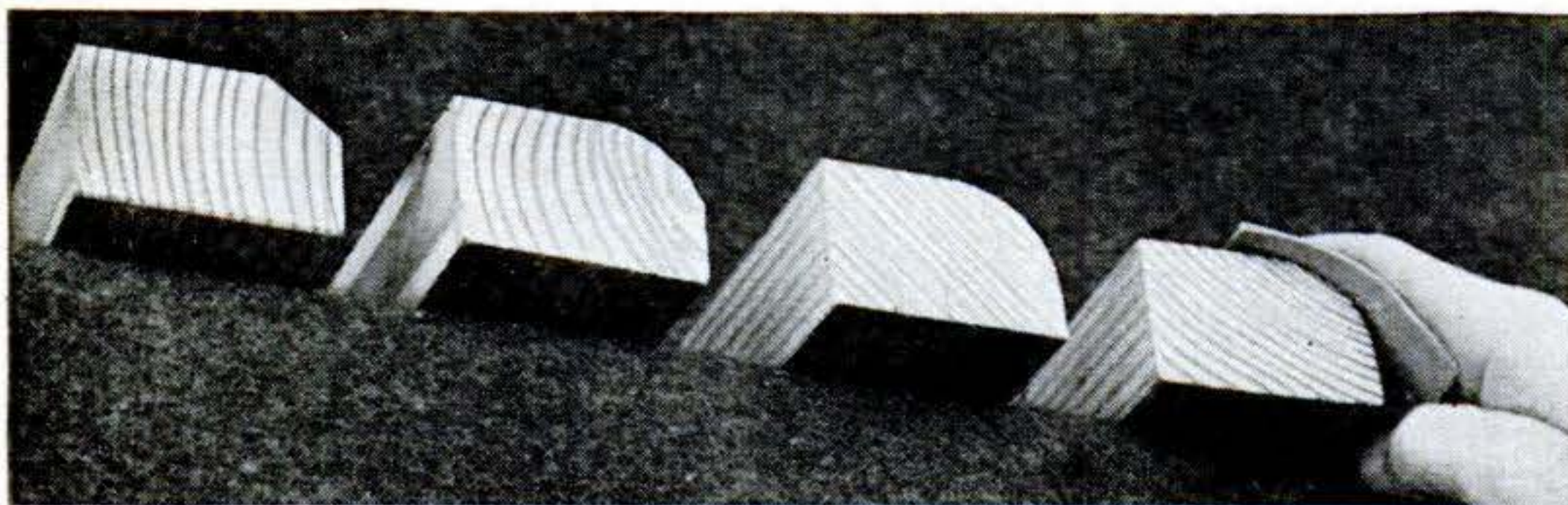

ROUNDING BY HAND: Plane corner to 45°, reduce high spots of angle by more planing, and finish by hand. Built-up corner is at right.

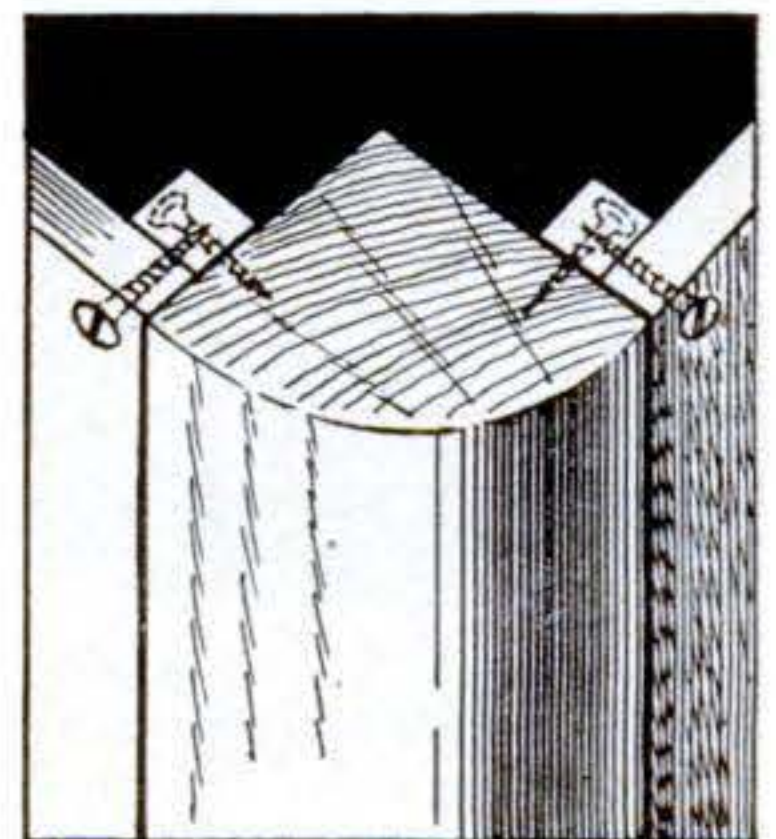

duces the two high spots of the angle and begins to round off the edge. Final finishing is done with sandpaper held in fingers.

Flat areas or bumps should be sanded out carefully. Finish with an over-all sanding with fine paper held in the fingers or wrapped around a block of cork.

Built-ups. Larger pieces must be built up, using thin panels glued to a framework to form the desired shape. Composition board is ideal for this construction and is inexpensive as well. Where two panels meet to form a corner they may be joined by a length of 2" by 2" pine. Two 1/2" by 1/2" cleats are screwed and glued to this corner post to form a fabricated rabbet. The panels are then glued and nailed to the cleats and the corner post rounded off.

Kerf curves. Another interesting treatment for curves is the application of a plywood apron or baseboard nailed to a curved shelf. The plywood is kerfed vertically on the back surface with a series of saw cuts about two-thirds through the material to facilitate bending. Spread glue on the shelf edge before nailing the plywood. This reduces the possibility of cracking after finishing.

Although close-fitting joints are always desirable, don't fret too much if you can't make the pieces match to a hairline. There are plenty of excellent nonshrinking wood fillers to fill in imperfections, and a good coat of paint can hide a multitude of sins.

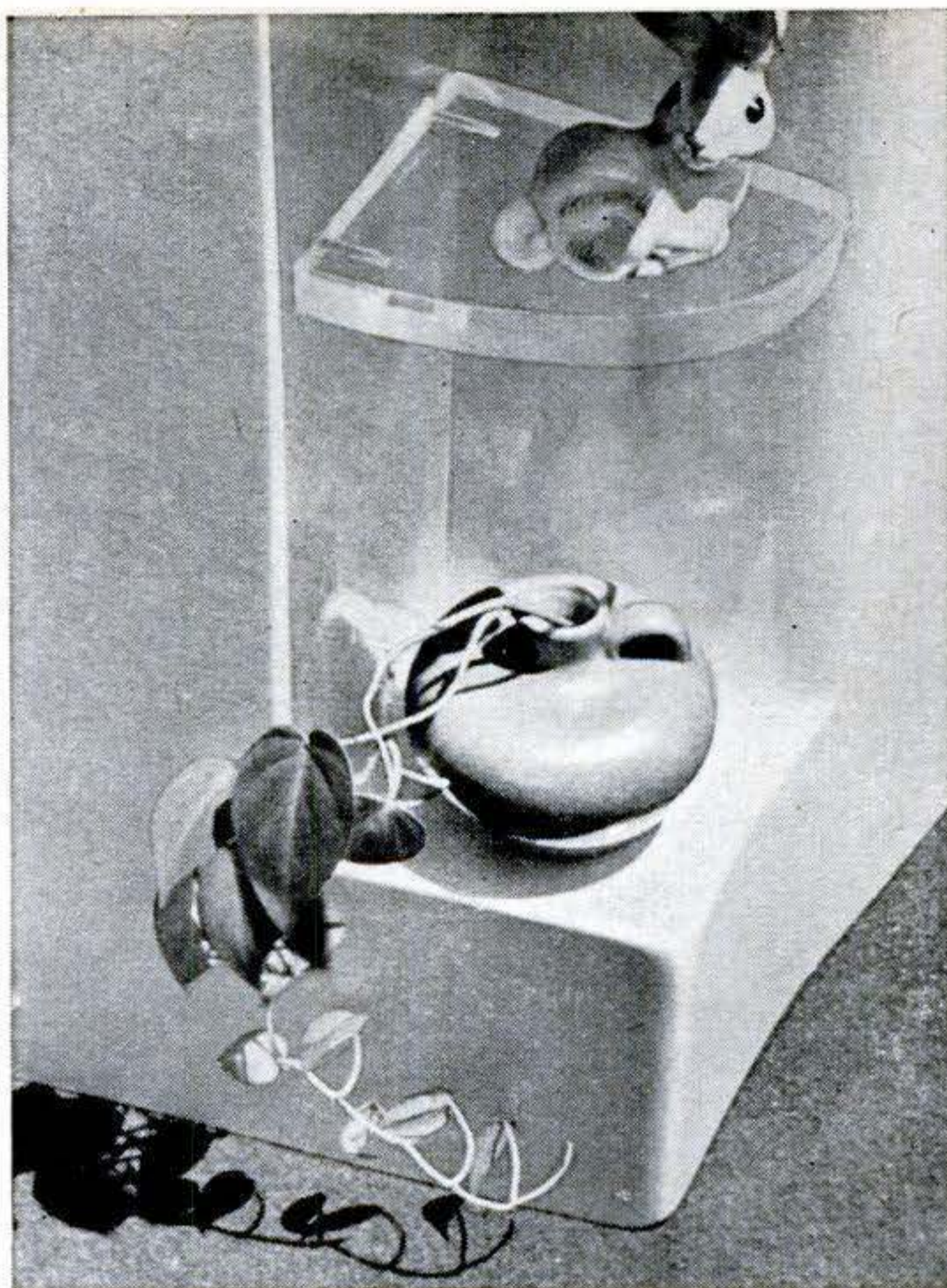

MIXTURE of wood and composition board in built-up at right becomes attractive piece above under unifying magic of enamel.

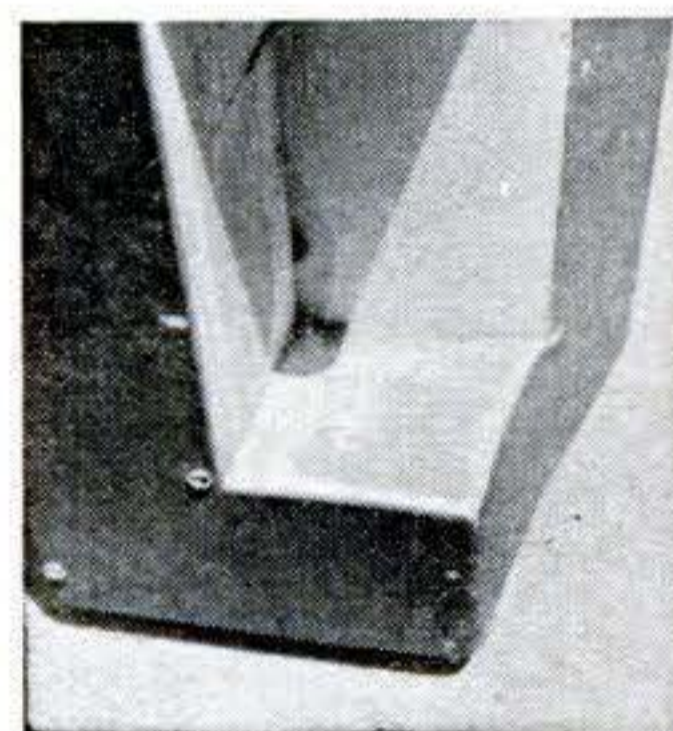

PLYWOOD SHEATHING

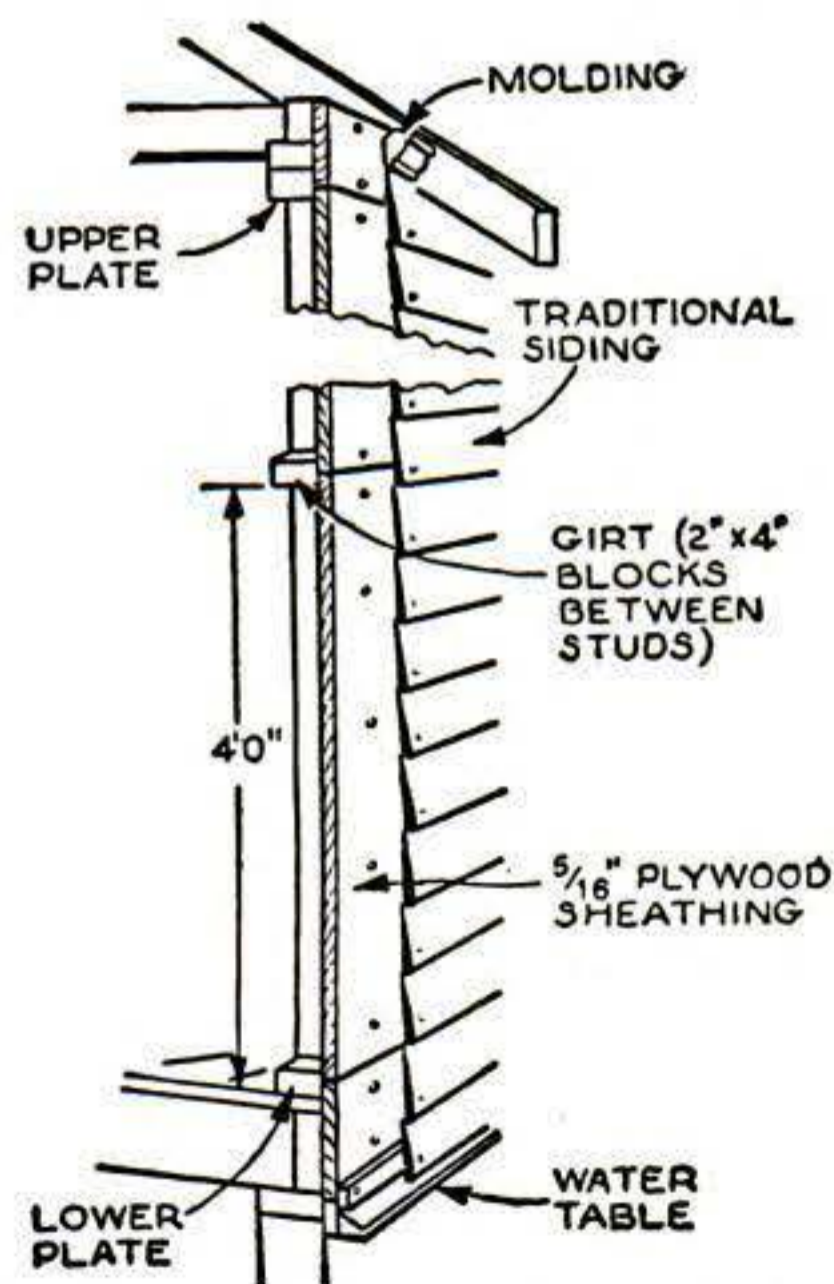

Plywood sheathing applied to ordinary frame construction imparts stiffness equal to diagonal boarding and saves much labor. Studs should be cut 1 1/2" less than 8' to provide an edge lap for nailing the plywood to the plates. If the sheets are put on horizontally, nail 2" by 4" stretchers between the studs 4' above the floor to form a girt for nailing the meeting edges of the plywood. Siding may be laid directly on the sheathing but insulation against heat and cold is much improved if 1/2" furring strips are nailed along the studs outside the sheathing to leave an air space.

The substitution of 1/2" exterior plywood for traditional siding results in labor saving and better insulation against temperature changes. Nailed over furring strips, with joints butted and calked with mastic, a flat surface is obtained. Joints can be emphasized in the design by locating them with regard to window and door openings and covering with battens or moldings.

To install lapped plywood siding over plywood sheathing, substitute wedges tapering from 1/2" to 1" for furring strips.

FOR YOUR POPULAR SCIENCE INFORMATION FILE

Announcing

Ultramodern

... with the versatile new Kodak Ektalux battery-condenser system

You'll find features galore in this sensational new lighting system for flash photography. Kodak Ektalux Flashholder, the basic unit, can be used alone, or with as many as six Ektalux Extension Units in perfect synchronization—B-C power from the Flashholder supplies all the energy.

Addition of the new Kodak Ektalux Solenoid permits you to use the accessory Remote Release for exposure control at a good distance from the camera.

And for cameras that have non-flash shutters, you get a complete external synchronizer by adding the Solenoid and Synchro-Switch to the basic Flashholder. Choice of brackets permits quick, rigid attachment of the Flashholder to practically any type of camera.

In all cases you benefit by the new pistol-

grip handle...the durable, light magnesium construction. Be sure to ask your Kodak dealer to put this versatile Flashholder system through its paces. You'll be amazed.

BATTERY
B-C
CONDENSER

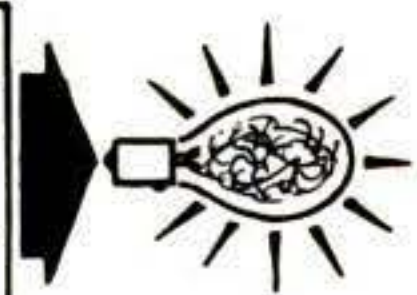
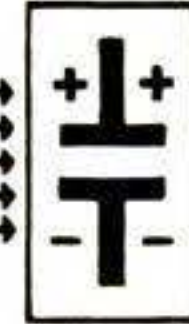

How battery-condenser power works

The B-C system brings to the Kodak Ektalux Flashholder a revolutionary new power supply. A small 22.5-volt photoflash battery feeds power to a condenser which stores the power until needed. The condenser then fires the lamp in a single surge *15 times as strong* as the force of the usual 1.5-volt flashlight battery. This uniformly high power surge insures flash performance of far greater dependability and scope than is possible with conventional battery operation.

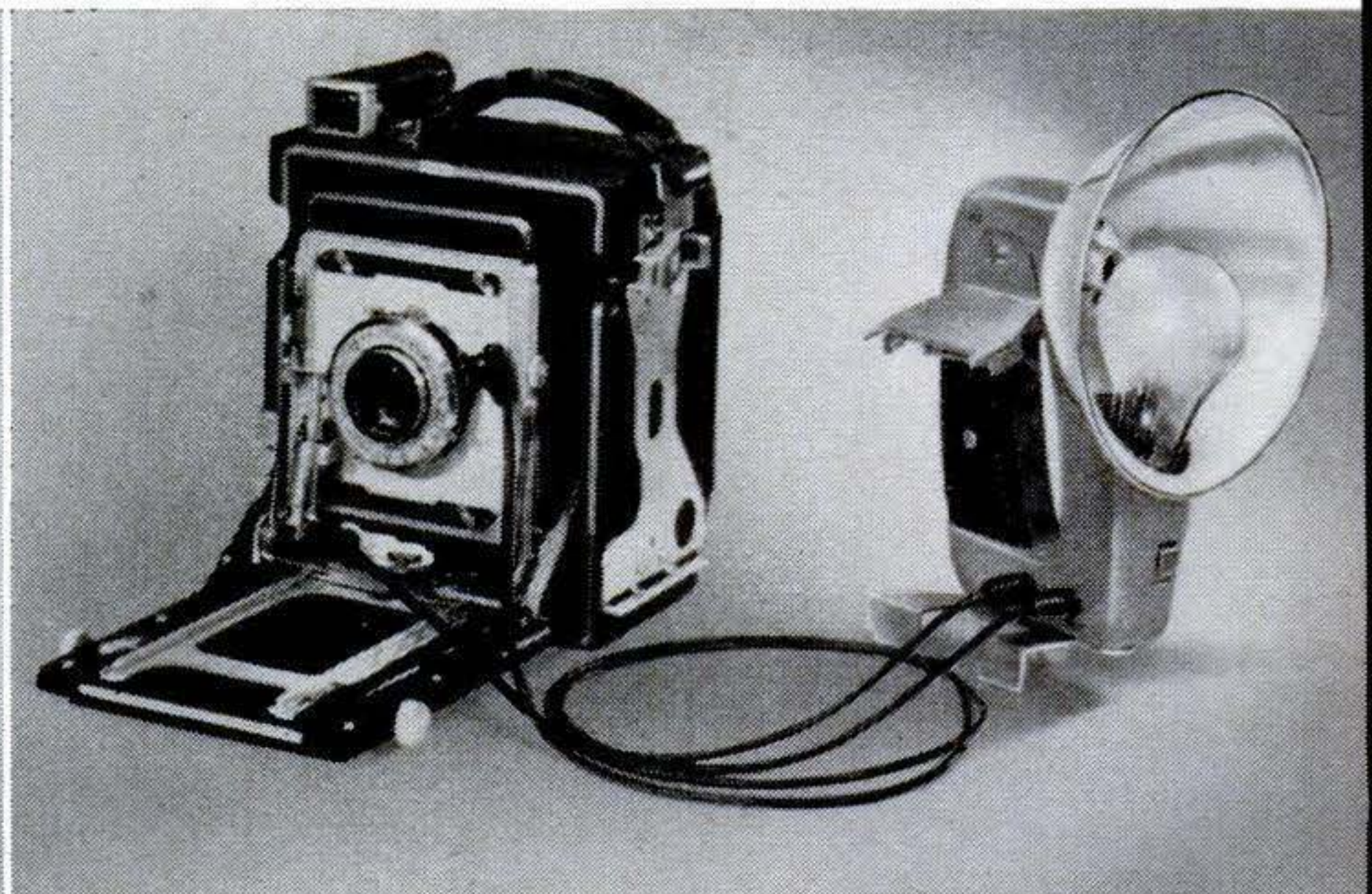
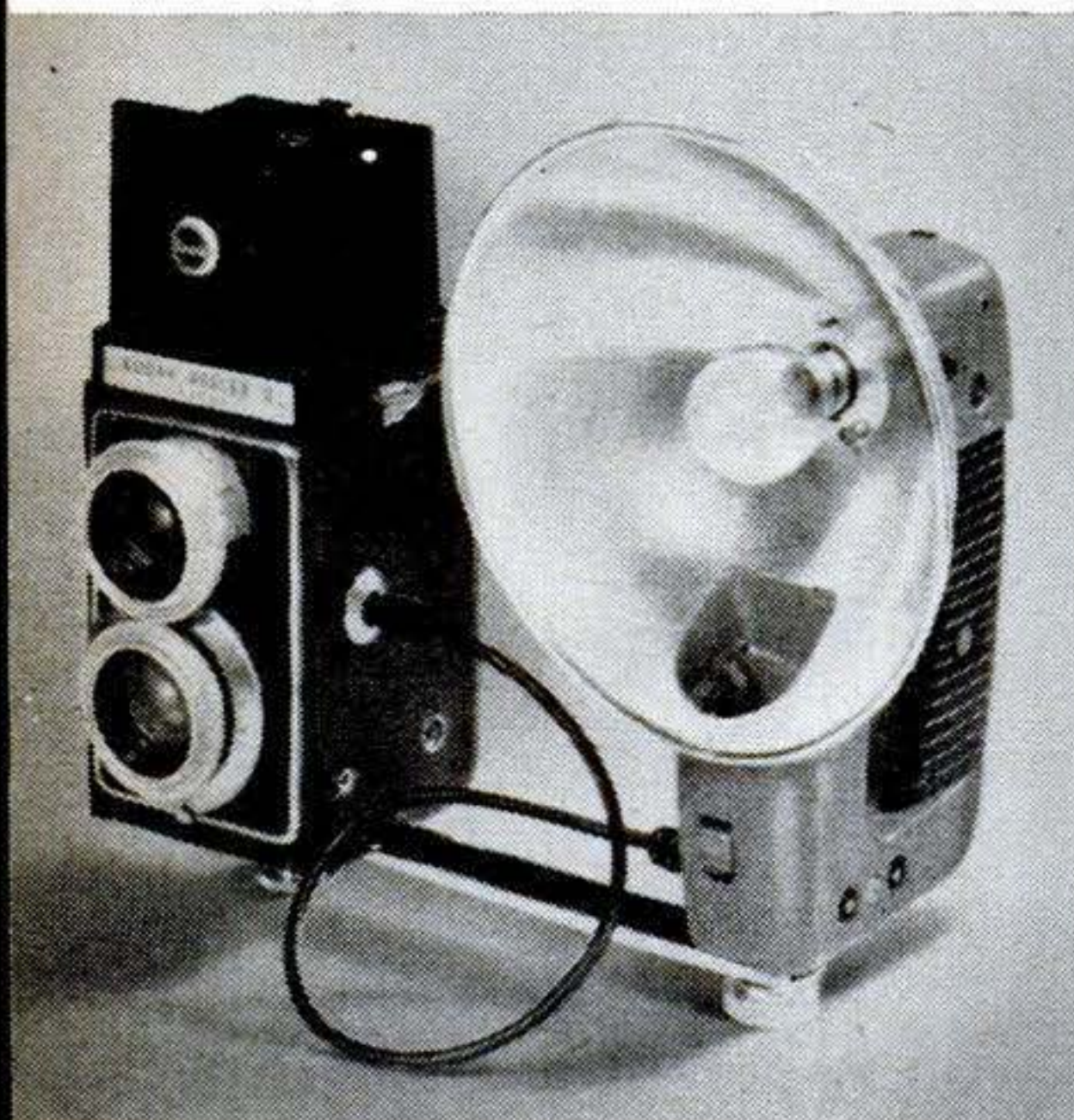

"Ektalux" quickly adapts to amateur or professional cameras

Use with practically any roll-film camera—Standard Bracket fits Ektalux Flashholder to most reflex, folding, or miniature cameras. For cameras that have built-in flash synchronization, no further attachments are required for this new high in dependable "flash" picture taking.

Ideal teammate for press-type cameras—By means of the Press Bracket, the Ektalux Flashholder can be fitted to most press-type cameras. Camera and Flashholder firmly lock together or detach quickly. A special bracket is also offered for the Polaroid Land Camera.

Flash

With Standard Bracket.....\$34.75
 With Press Bracket..... 39.50
 With Bracket for Polaroid Land Camera..... 35.75

ACCESSORIES EXTRA

Prices are subject to change without notice and include Federal Tax applicable when this advertisement was released for publication.

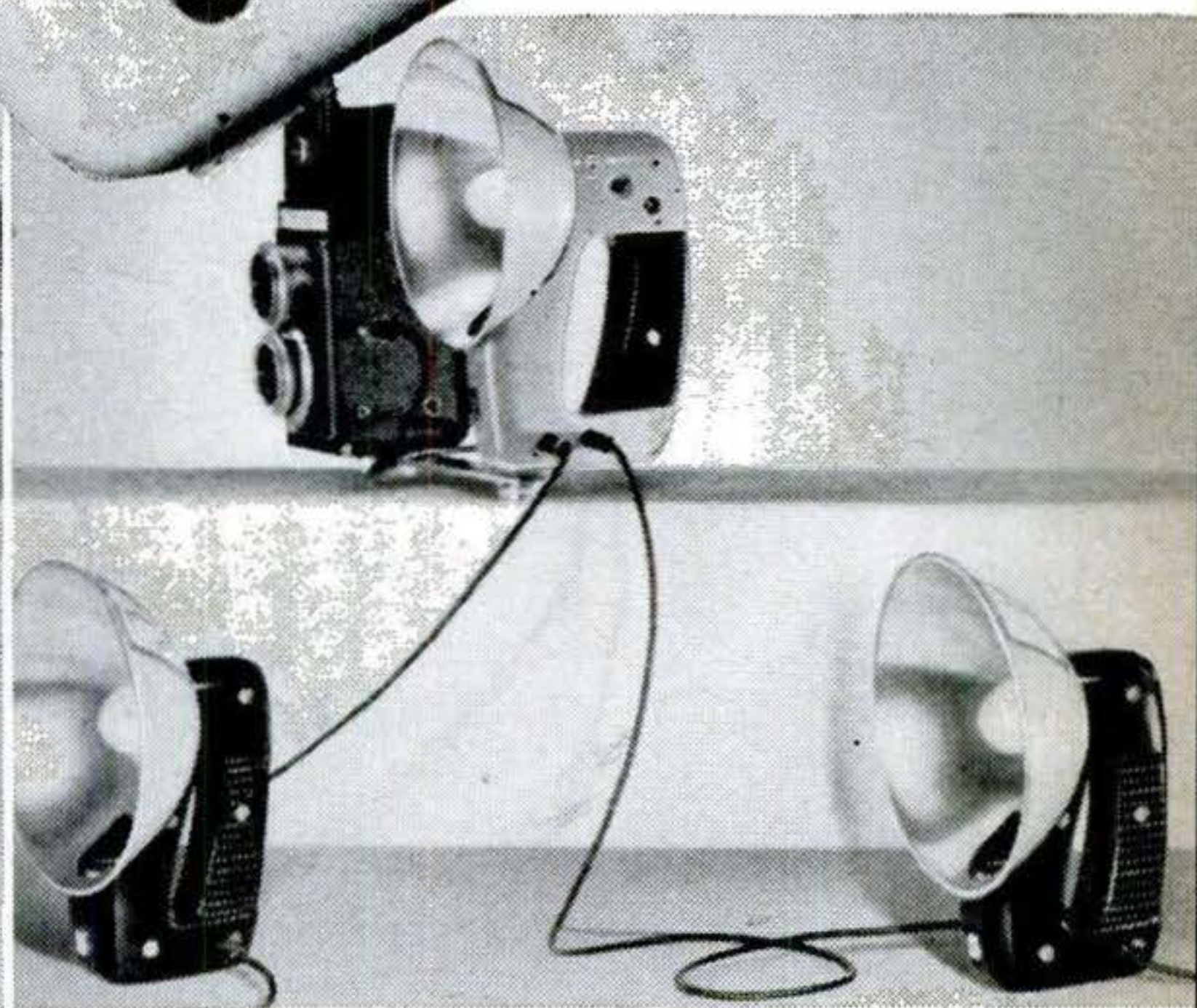
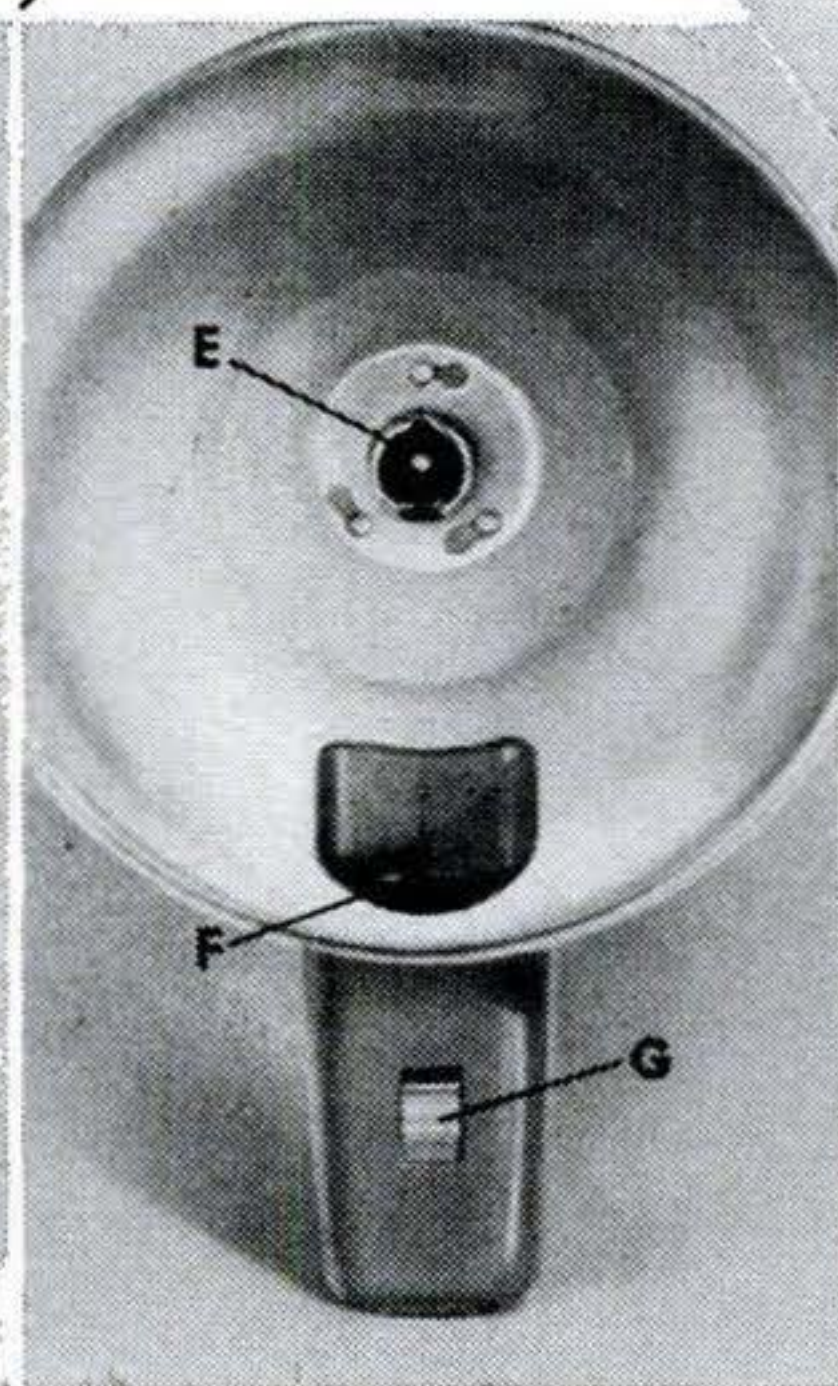
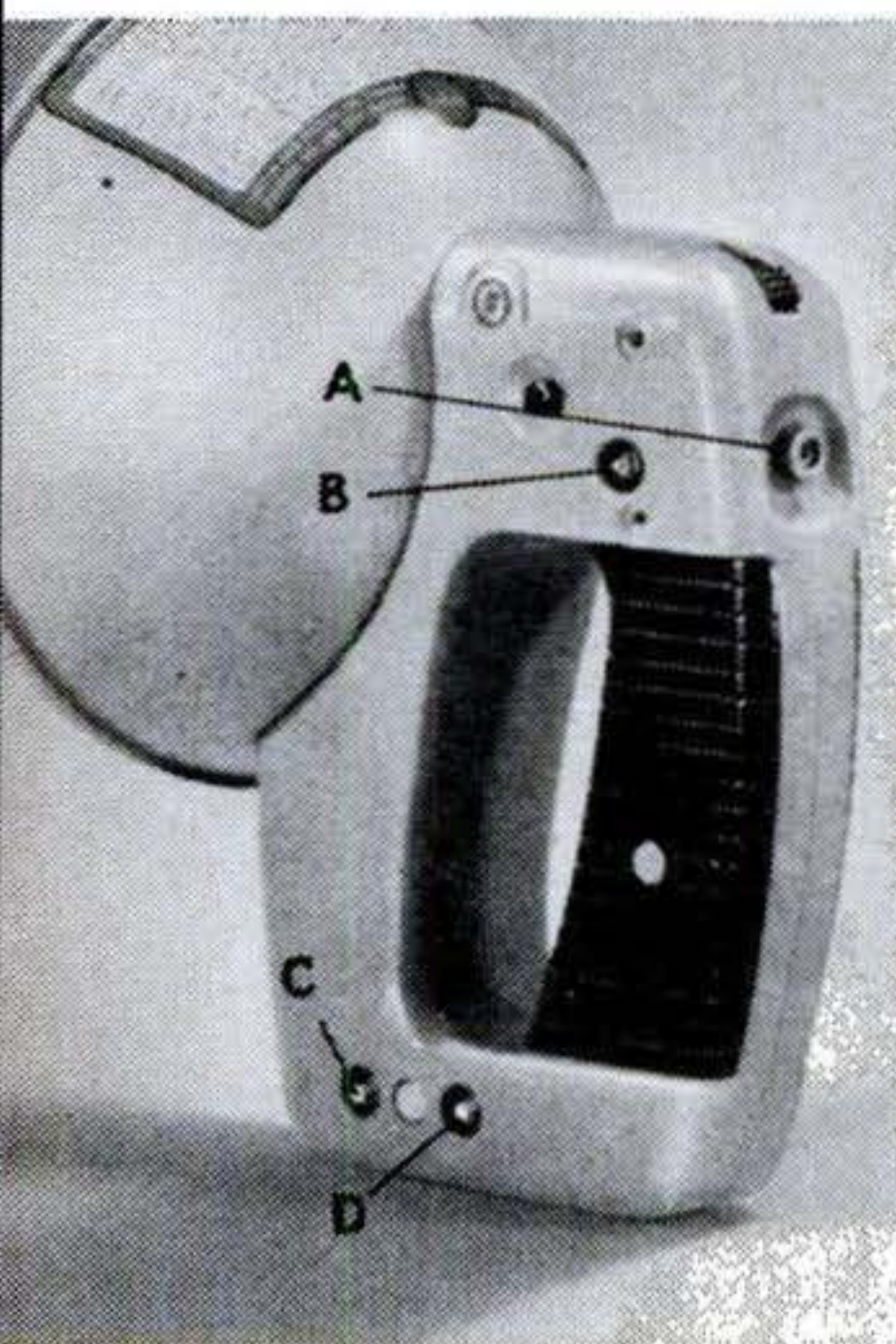
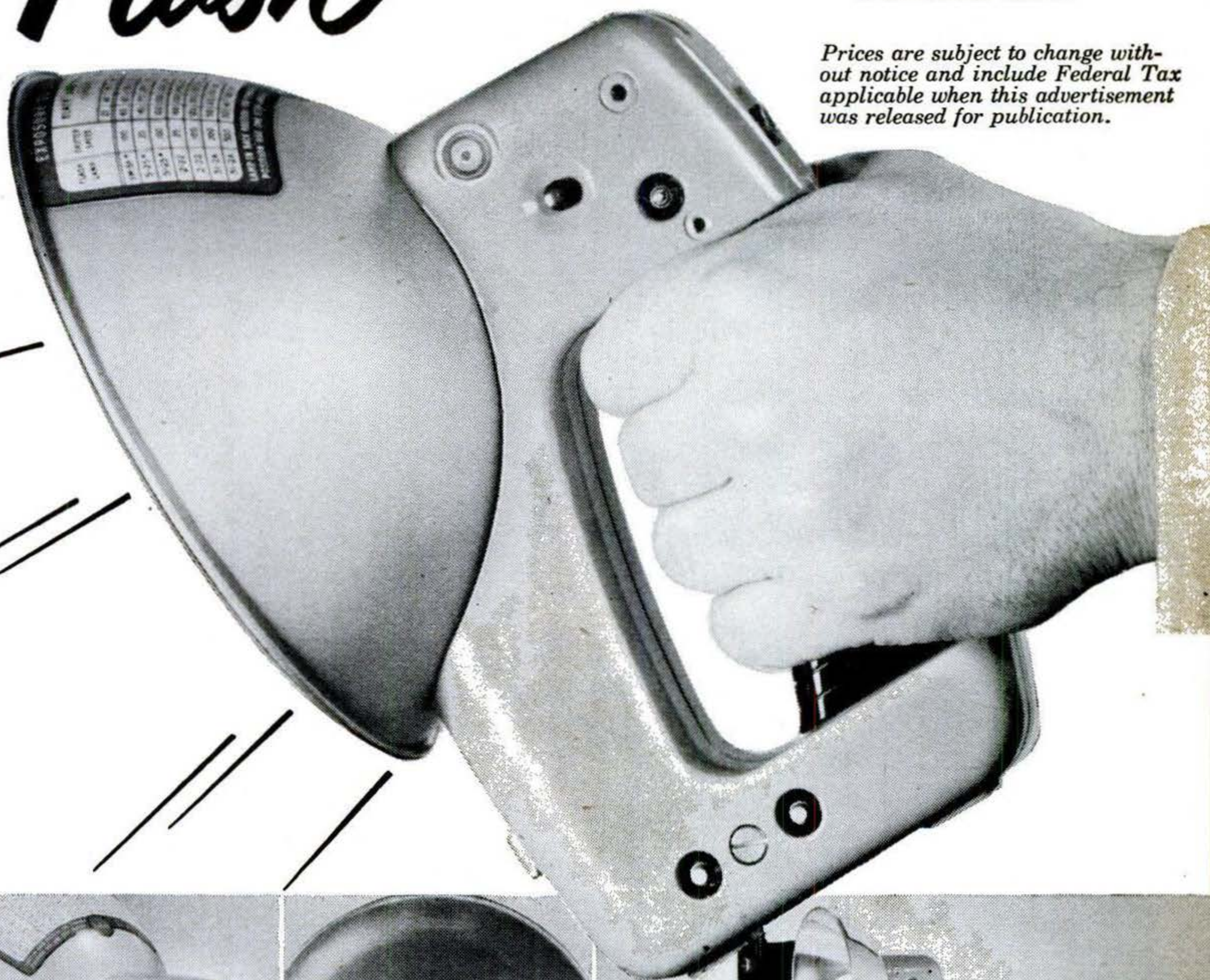

Accessory outlets are handy
 —Button **A** is Solenoid release that permits tripping shutter from Flashholder. Outlet **B** accepts the Remote Release. Outlets **C** and **D** take Extension Units. The entire system is series-wired.

Lamp system is flexible—
 For midget lamps, note socket **E**; provides for two-way focus. Ejector is in back. **F** is socket for medium-base lamp, with its ejector **G**. A handy exposure table is on back of reflector.

Outstanding choice for multiple flash
 —Extension Unit cords may extend to either side of the camera. Each unit can then be hooked to another unit. Units stand steady on flat surface. Socket in base fits tripod or Clamp. Removable reflectors nest; handles stack for storage.

**EASTMAN KODAK COMPANY,
 ROCHESTER 4, N. Y.**

Kodak
 TRADE-MARK

Doc Evants thought for a minute, tugging at his chin. "Are you suggesting that her protests might be the symptoms of some inherent mechanical difficulty?"

Gus nodded.

"I doubt it, but you have my permission to examine her. I'll stroll on down to Mrs. Bentley's and have a chat. I've got the first chapter on my new book, *The Inconsistencies of Human Thought*, that I'd like to show her. I'll drop back here later."

Gus Gets to Work

"What's the trouble with the old screwball's car?" Stan asked after they'd driven the sedan into the shop.

"Engine misfires on sharp left turns. I've a hunch it's either dirt in the gasoline line or a damaged carburetor float that gets stuck when centrifugal force throws it to the right on a sharp left-hand turn."

Before he checked either of these points, he got into the car, started the engine and proceeded to turn the steering wheel as far to the left as he could. He looked a little disappointed when the engine continued to purr along without so much as a missed beat. Finally, he shut off the ignition.

"What's the matter, boss? Think maybe the steering gear had something to do with it?"

"Just thought I'd check. But no luck."

And Gus had no better luck with his hunches about dirt in the gas lines or the gas tank or a faulty carburetor float.

Stan Stumbles on a Clue

"Boss, maybe the old doc's got something in this sent—sentiency stuff. You know—about cars being like humans. They sure suffer from some of the same ailments—clogged-up arteries, head troubles, breathing ailments, stiff joints, shorted nerves, and..."

"Son, I think you've got something there. Why the devil didn't I think of that before?" Gus all but dove in under the open hood and began to check the wiring.

After about five minutes Gus straightened up and his face was all smiles.

"Take a look at this." He pointed down at the solenoid that operated the car's overdrive, then hit it with his finger.

Stan saw that the unit was quite loose on its moorings and that the insulation on

one of the heavy wires leading to it was badly frayed.

"Every time the car would swing to the left," explained Gus, "the solenoid would swing to the right and that bare spot on that wire—the one that leads to the ignition—would ground out against the car's frame. When the car was going straight or turning right it wouldn't touch the frame."

It didn't take Stan and Gus long to make the repair. Gus was just washing up when Evants walked in.

Gabriella Acts Like a Lady Now

"Well, Mr. Wilson, has your stint of research convinced you that Gabriella II was warning me not to see Mrs. Miller today?"

"No, I'm convinced it was as you would say, 'a slight inherent electrical difficulty.' But she's all fixed now and ready to go."

"Splendid, splendid. I am truly grateful. . . . I—ah—happen to be a bit short of funds at the moment," Evants went on, fumbling in his pockets without conviction, "but send me a bill, by all means. And now I must hurry along to Mrs. Miller's."

"As a matter of fact," he confided, "I have a most important question to propound to that dear lady. Now that my fears have proven unfounded, I shall proceed with confidence." And with an airy whisk of the hand, he drove briskly away.

Gus Wishes the "Doctor" Luck

"Well, I'll be darned," said Gus, "if the little doctor hasn't got matrimony on his mind—and it'll be a pretty good catch for him if he makes it, which I suspect he will."

"Gee, boss, just think," mused Stan, "if you hadn't spotted the trouble, Doc Evants would've gone right on believing Gabriella was trying to warn him, and he might never have popped the question. Well, I wish him luck."

Gus, confirmed bachelor, grinned contentedly and reached for his pipe. "Me too," he said.

END

Make Trouble Pay

Had any interesting car breakdowns lately? Gus wants to hear about your tough and tantalizing automotive problems. Write him about the false diagnoses as well as the cures. *Popular Science* will pay \$25 to the first sender of each usable story idea. Letters can't be acknowledged or returned. Address: Martin Bunn, *Popular Science*, 353 Fourth Avenue, New York 10, N. Y.



the right step to
MAKE BIG MONEY
all your life!

BE YOUR OWN BOSS!

Here's the big **LIFETIME OPPORTUNITY** for the man who wants to get ahead in something for himself—wants to earn \$35 to \$50 a day—wants to *be his own boss* and keep all the profits from his own labor!

It's easy to start a floor sanding business of your own with American Machines! Thousands of men have been successful with our plan. No experience or special schooling needed. American Sanders are easy to operate, speedy, dependable. Your age makes no difference—men 18 to 80 are active in floor surfacing and make a good living.

Pleasant indoor work . . . steady all year round. Prospects everywhere . . . new and old floors. No large investment. Work out of your own home. Use passenger car for taking equipment from job to job. Easy to get jobs—business mushrooms—and *you are boss!* Send today for "money-making" booklet entitled "Opportunities in Floor Surfacing"—use coupon and enclose 25c in coin or stamps to cover handling.

**SEND FOR
 TELL-ALL
 BOOKLET!**



The American Floor Surfacing
 Machine Co.
 532 So. St. Clair St.,
 Toledo, Ohio

Enclosed find 25c in stamps or coin for booklet "Opportunities in Floor Surfacing", telling me how I can start my own floor sanding business.

Name.....

Street.....

City..... State.....

A M E R I C A N
F L O O R M A C H I N E S

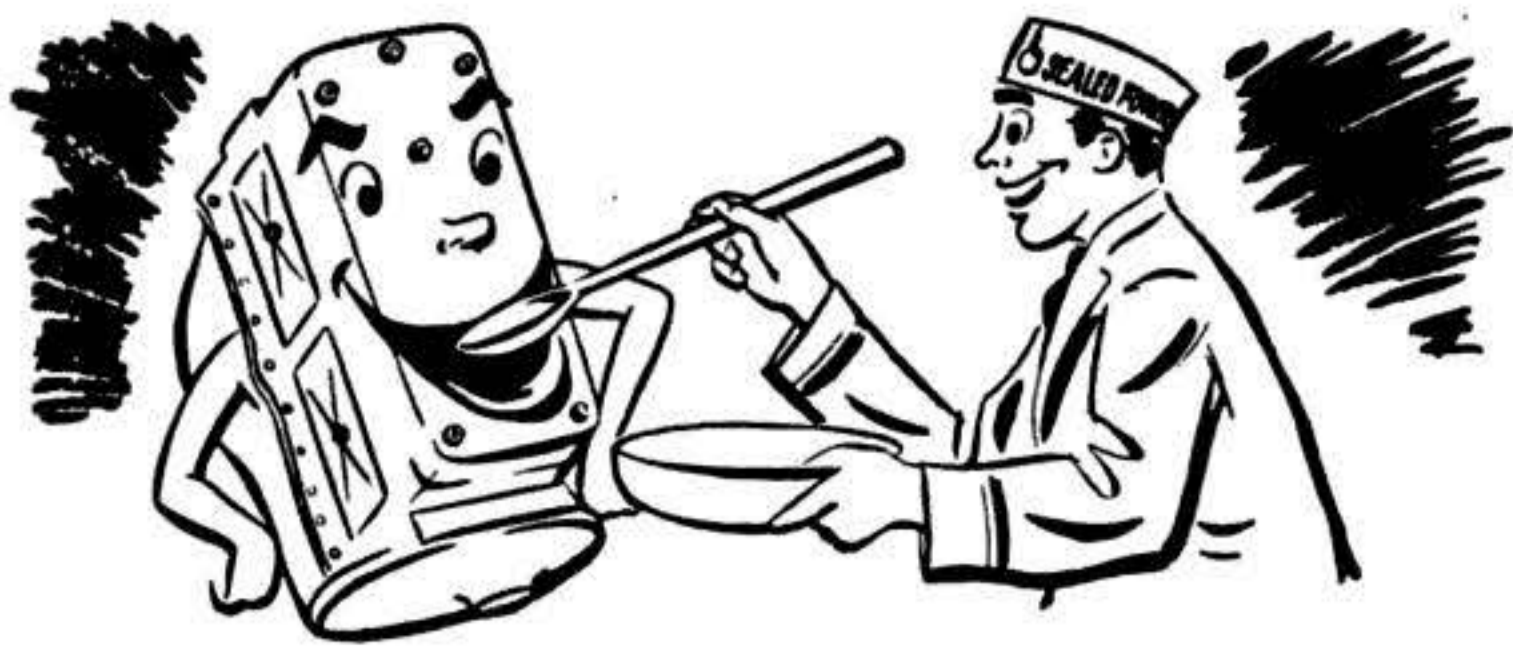

Care and Feeding of Engines

BY S. P. CORP

PLUG YOUR LOSSES

When a cylinder block is cast, large holes are provided in the side of the casting for cleaning. These holes are stopped up with plugs known as expansion plugs or Welch plugs. They are about two inches in diameter,

and are forced into position to keep water from leaking out. At times they do leak, and you lose expensive anti-freeze.

To remove one of these plugs, drive a small punch into its center, which will dish the plug so it falls

out. Clean the hole of all rust and dirt. Make sure new plug is free of sharp edges. Fit new plug into its seat in the engine block, curved side out, and expand it by flattening it with a blunt drift and hammer. A good sealing compound may be placed around plug before installing. Check engine for water-tightness.

MUSTN'T BE TOO TIGHT

Don't draw a cylinder head down too tight, or it may cause engine to pump oil. When checking engine head for winter operation, use a Torque wrench to make sure all cap screws and nuts are tightened evenly. Center cap screw or nut should be tightened first, then next row on each side, as in diagram.

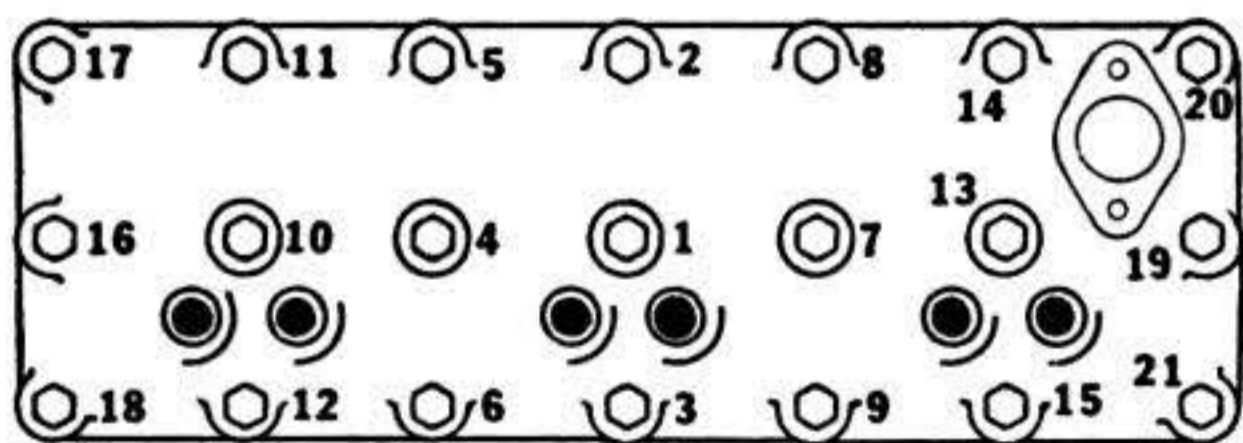

This method will iron out the head gasket, preventing leaks and distortion. Apply 65-70 foot-pounds of pull for cap screws and 50-60 for cylinder head nuts.

IF YOUR CAR DRINKS TOO MUCH

An engine that uses too much oil needs new Sealed Power piston rings. The Sealed Power MD-50 Steel Oil Ring does the world's best job of oil control, even in badly tapered and out-of-round bores. Your dealer has Sealed Power Rings or can get them for you. They save gas, save oil, restore original power to your engine and lengthen its life. A postal to "Sealed Power, Dept. H-1, Muskegon, Mich." will bring you free a helpful book, "7 Ways to Save Oil."



His Camera Earns Over \$500 a Day

[Continued from page 195]

2:00 A.M., worrying, he stopped to watch a photographer shoot a store-window display. As the photographer started to pack up, Richie moved in and made him a proposition. He wanted a montage of night-club signs, but he had no idea how to make it himself. If the window man would shoot it, Richie would split the profit.

Window Man Becomes Partner

Agreed, they hailed a night-owl cab and buzzed around town shooting neon signs. Later, dividing the spoils, Richie discovered that the window man was bored with windows and ached to get into greener fields. Richie annexed the window man's technical skill to his own business ability. From him, and from experience, he gradually learned basic photography—and developed a personal style that made him famous.

As you'd expect from a hyper-thyroid, Richie's style is hyper-drama. Where most photographers would use two or three lights, Richie uses a dozen. He sticks them wherever they'll reflect white hot off every metal surface back into his lens. He leaves his shadows jet black. This range of tone makes his pictures jump right out at you.

For this technique he uses compact, lightweight "RSP" bulbs, which consume only 500 watts but burn at an overvoltage that makes them give as much light as 1,500 watters. Their built-in reflectors squeeze the light into a narrow 20 degrees. They last only six hours, but while they last they can fry an egg at five feet.

For large areas he has to use flash bulbs—sometimes \$20 worth at a shot. To save the time of replacing the burned-out bulbs for a second shot (not to save another \$20) he uses three or more extra cameras to get different angles, all at the first bang.

How to Pose a Locomotive

When necessary, Richie will do anything short of murder to give his client an exciting, unusual shot. General Motors wanted a dramatic picture of two Diesel locomotives in the making. Only the Diesels' rear ends were showing. Richie persuaded the plant foreman to have one of the engines turned around, to have arc welders brought into the work area, to haul up a lot of bright, shining beams to fill a dark, blank area. It took several hours of crane work

[Continued on page 230]

The Biggest Money Saving Idea in Car Maintenance in 20 Years



STOP those endless repairs that keep pulling \$10 bills out of your pocket.

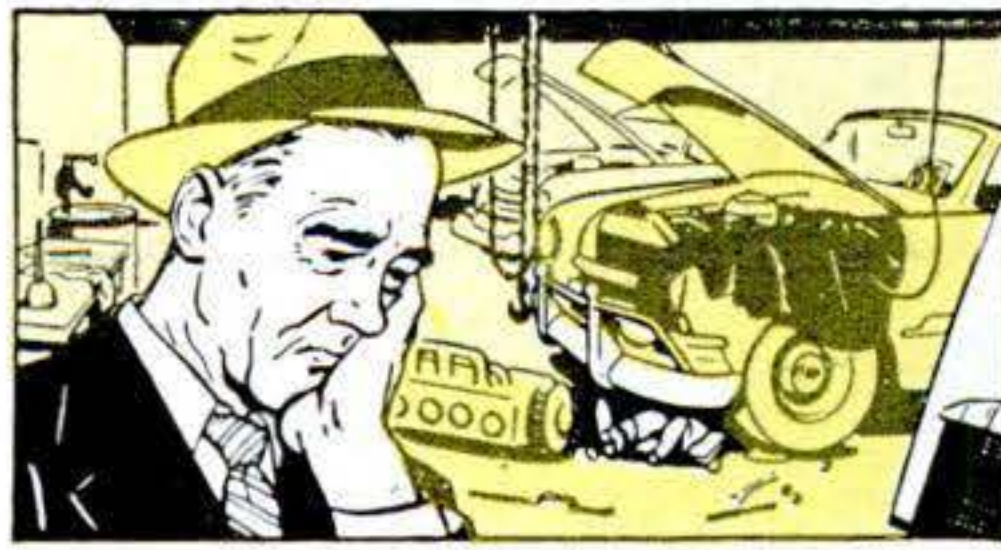

STOP expensive overhauls that still leave things undone to break down later.



STOP paying high gas, oil and maintenance bills on an unsafe, worn-out engine.

New Kind Of Replacement Engines ...Successor To Costly Overhauls!

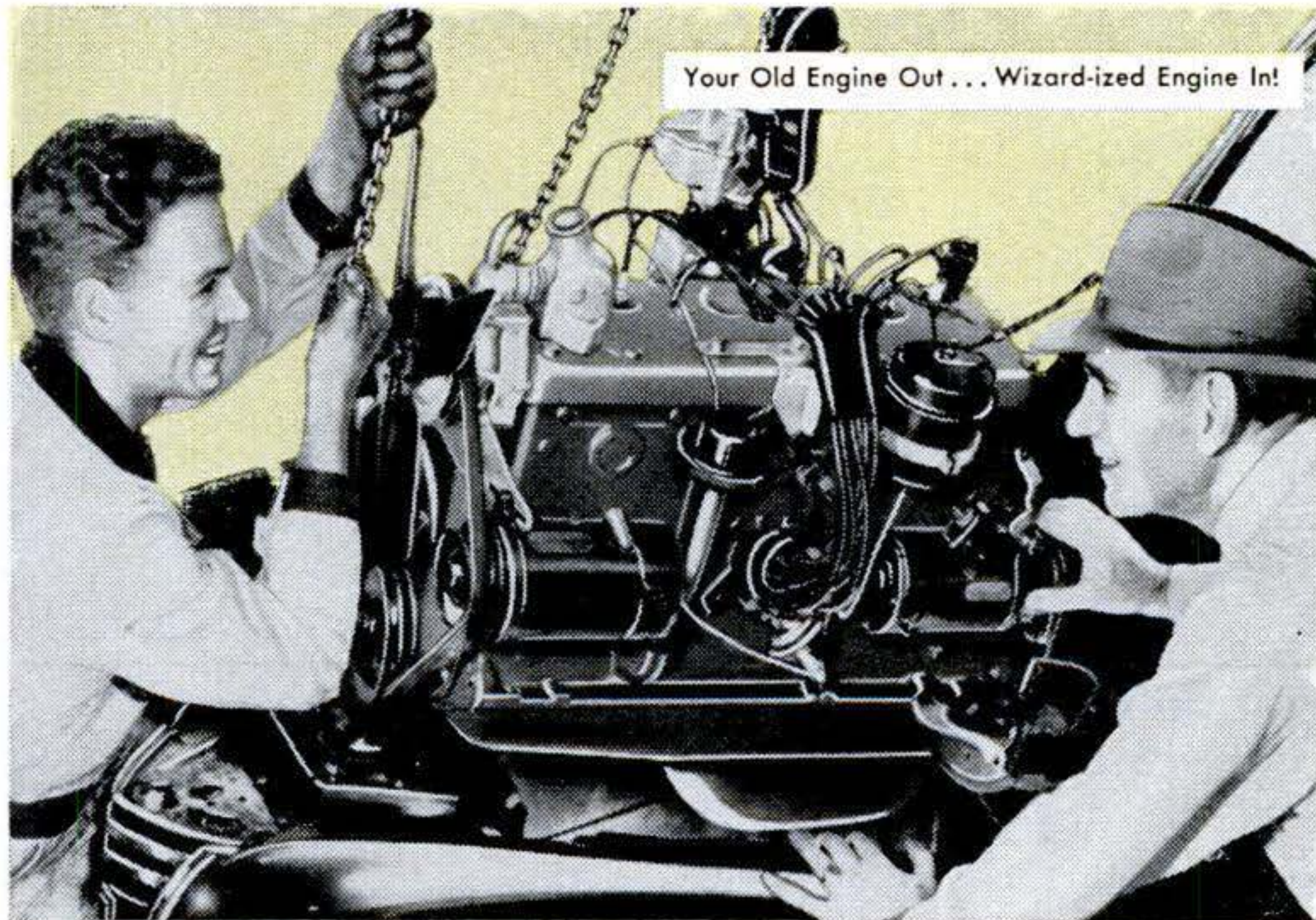

No Regular Overhaul At Any Price
Can Match Your New
Factory Remanufactured*

Wizard-ized Engine!

HERE, AT LAST, is a new kind of replacement engine for your car! . . . so much better than partially rebuilt engines or ordinary overhaul jobs that thousands call it the successor to costly overhauls!

*NOT A SO-CALLED "REBUILT" but completely remanufactured in 5 large factories, this Wizard-ized engine gives you an easy, low-cost way to end costly repair bills. And you can . . .

GET ANOTHER 50,000 OR MORE MILES from your present car! That's because . . .

EVERY MOVING PART IS BRAND NEW top quality or fully remanufactured to function like new. Over 150 new parts. That's why you can buy with new car confidence. In fact, Western Auto gives you . . .

THE SAME GUARANTEE THAT COMES WITH A NEW CAR ENGINE—plus a free 500-mile service inspection of our installation. Still this Wizard-ized Engine is . . .

PRICED FAR BELOW THE COST OF A NEW ENGINE . . . or about the cost of a bearing, ring and rebore overhaul! Our . . .

INSTALLATIONS ARE MADE BY trained mechanics in fully equipped garages. So . . .

SEE YOUR WESTERN AUTO MAN TOMORROW . . . ask about his trade-in allowance for your old engine!

Enjoy again the new-car thrill of an engine that's packed with surging power . . . power to level any hill . . . power to pull out of tight spots in traffic . . . power that means years of care-free driving and day after day dependability. You

can have it now in one complete, guaranteed package in a Wizard-ized Engine. (Attached engine accessories are used from old engine, or may be replaced new.) Yours on easy Western Auto terms!

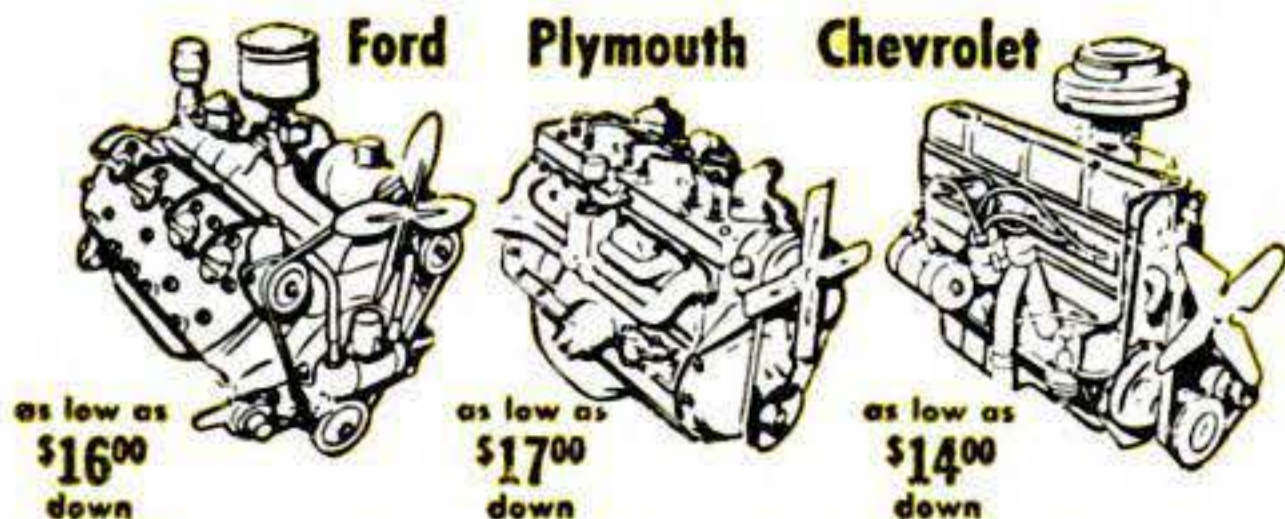

(Terms vary by area, make and model of car.)

GUARANTEED
New Car Engine
Performance for
Chevrolets, Fords, Plymouths,
Chryslers, Pontiacs, Mercurys,
Dodges, Studebakers, DeSotos,
Olds and other popular makes.

Wizard-ized Engines

FACTORY REMANUFACTURED

The Engine You Can Buy with New Car Confidence

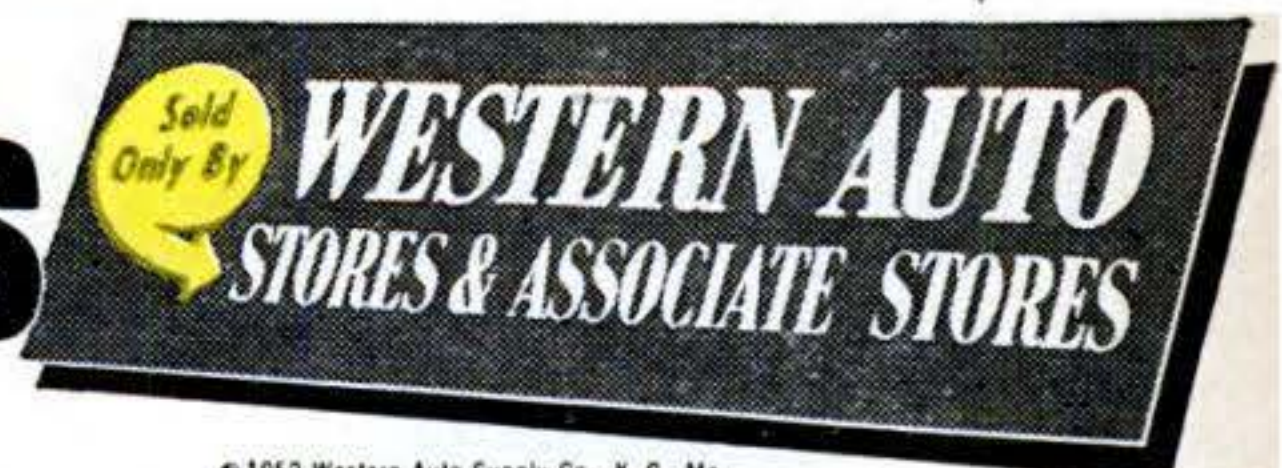

© 1952 Western Auto Supply Co., K. C., Mo.
NOTE: Western Auto Associate Dealers own their own stores and set their own prices. Terms quoted are recommended terms, subject to variance.

PS-12

**NOW—40 different cuts
with AMAZING, NEW**

Warren

**DADO SAWING WASHERS
ON YOUR SAW BLADE!**

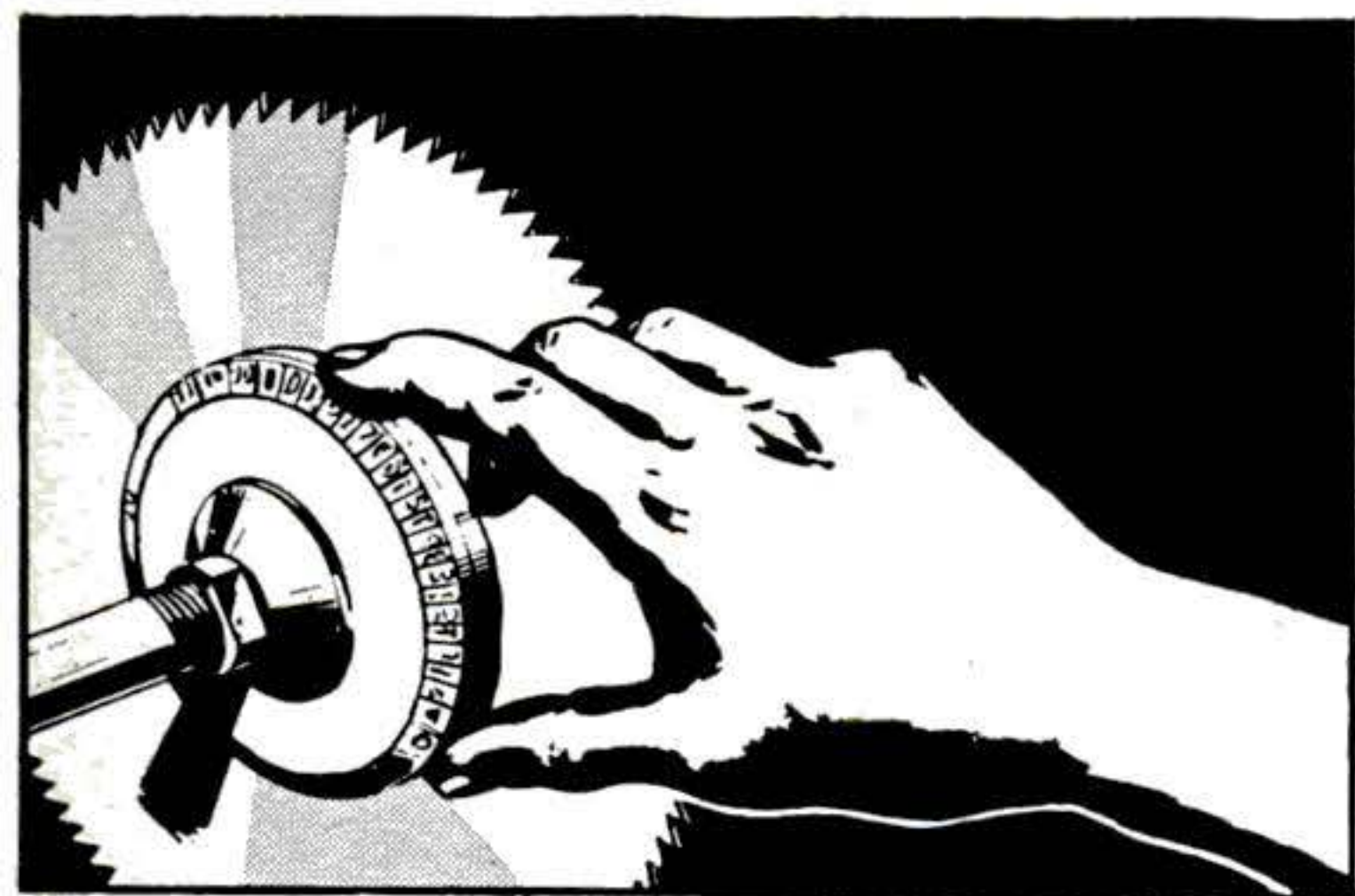

**NO WARP...
NO WOBBLE...
NO BURNING!**

**4 WASHERS
MEAN PERFECT
BALANCE**

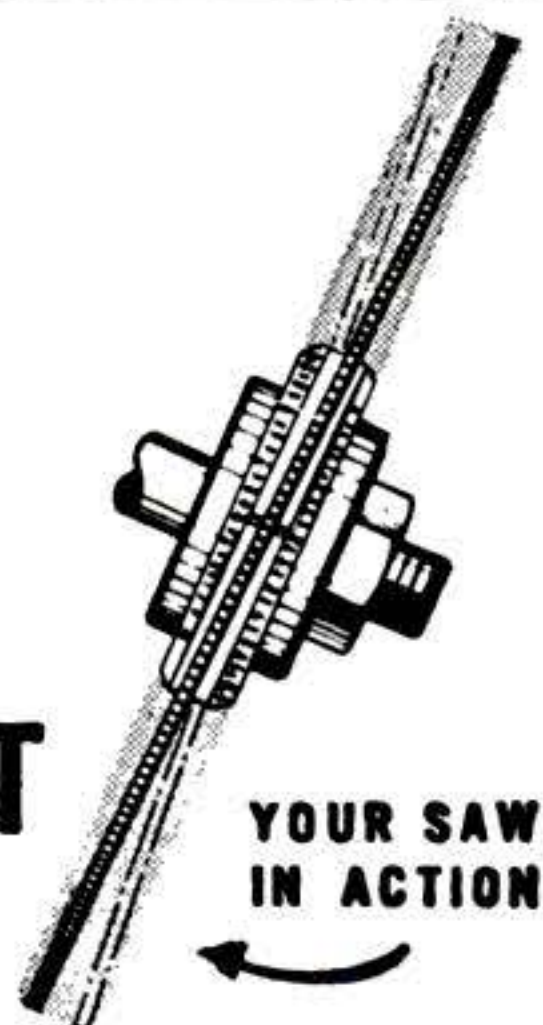

Make clean, smooth parallel grooves at any angle—no chewing, no sanding. Just dial your cut—no trick screws, no vibration, strengthens blade for straight cuts. Warren Washers greatest improvement in 30 years—and most copied—look for the name on the box and washers. It costs no more to get the best—**WARREN, IT'S GUARANTEED!** At your dealer or order direct. Give arbor size— $\frac{1}{2}$ " , $\frac{3}{4}$ " , $\frac{5}{8}$ " , 1"—sent postpaid.

**ONLY
4⁹⁵
PER
SET**

**WARREN DADO
SAWING WASHERS CO.**

Dept. 41 • Box 98, North End Station
Detroit, Michigan

His Camera Earns Over \$500 a Day
[Continued from page 228]

to turn the locomotive around. Meanwhile Richie was firing away in another part of the plant. When everything was set, Richie returned, used a public-address system to spot workers in his composition, and shot a picture that has become famous.

When Richie starts a job, he finds out first thing what *idea* the client wants to get across—not what things he wants photographed. Then Richie “cases the joint” looking for subjects to illustrate the ideas.

On this “casing” tour he takes along a batch of junior executives. As he strides through the plant he gives them orders: “Paint that machine gray—here’s a sample color” . . . “Have 300 hospital-clean differentials piled up in that corner” . . . “Get 50 workmen in oily clothes lined up on that staircase” . . . “I’ll shoot the gray machine in half an hour, the differentials an hour later, the men on the staircase right after that.”

Richie’s top fees have been for pictures attempted by other photographers without success. Plymouth paid him \$1,500 for just one indoor shot of endless rows of cars. They had tried it themselves and hadn’t gotten enough cars in the picture.

Boeing also paid him \$1,500 for a trick shot of a giant bomber being tested. While the body was held rigid, the wings were first bent far up and then far down out of normal. They wanted a superimposed shot with three wings on each side: one normal, one elevated and one depressed. The camera working space was cramped, the background was so cluttered you could hardly see the plane, and the problem of lighting the huge structure was gargantuan. That day’s work, says Richie, was well worth the \$1,500.

Aerial Photos Are Tricky

Richie’s mobile picture factory includes a truck, station wagon and his Beechcraft Bonanza.

To shoot from the air, he throttles back to 100 miles an hour, goes into a descending turn near the CAA minimum, holds the control yoke with his knees, picks his camera off the floor and snaps a picture—two if he’s quick and lucky. Then power is pushed on, the camera goes back on the floor fast, and the window is slammed shut. Richie recommends this only in calm weather.

Of late, Richie, has been doing more
[Continued on page 232]

See, try, compare — you, too, will choose Westcraft Tools over all other brands



Like thousands of other tool buyers, you'll be surprised to discover how much you save by choosing famous, professional-quality Westcraft Tools. They give you the precision engineering

and lasting accuracy you'd expect to find only in more expensive tools. See the complete line of guaranteed Westcraft Tools this week . . . yours on easy terms at Western Auto.

① **1/4" Electric Drill**, 115 volt; AC-DC; 60 cycle. 650 RPM Chuck. Lightweight, ideal for general utility. 1-year guarantee. Only . . . (2H1379) **\$11.95**

② **14-Piece Accessory Kit** for electric drill. Attachments for sanding, polishing, grinding, etc. Baked enamel steel box. Real time-saver. (2H1378) **\$4.75**

③ **4-Piece Wood Bit Set**, converts 1/4" drill to bore holes up to 1/2" diameter and 3 3/8" deep. Yours for **\$2.47** only (4HR6750)



17-Piece Socket Set, 1/2" Square Drive. Alloy steel, chrome plated. Complete with 12 sockets, reversible ratchet, 4 fittings. Heavy gauge steel tool box with red, baked-on enamel finish. A low-cost basic kit for mechanics, home owners, farmers. (HR2951) **\$19.45**



7" Lobster Claw Plier. Patented leverage design gives 50% more gripping power, 1/2" to 1". No other like it. (HR1125) **\$1.29**



Screwdriver, alloy steel, chrome-plated, 4" sq. blade. Positive-grip, shockproof plastic handle. Professional quality. (HR1361) **85¢**

Professional Quality—Wizards of Performance

WESTCRAFT TOOLS

Sold by the largest group of associated tool departments in America

WESTERN AUTO

STORES & ASSOCIATE STORES

Sold
Only By

NOTE: Western Auto Associate dealers own their own stores and set their own prices. Terms and conditions quoted are recommended, and subject to variance. Prices are subject to change without notice. ©1952 (PS12)

His Camera Earns Over \$500 a Day

[Continued from page 230]

motion-picture work. He got his movie start when a Texas Co. official sent him off to South America. The company liked the finished film so well it ordered three more.

An Arabian Nightmare

Shooting a later film in Arabia, Richie covered 150 widely separated locations in three weeks. Daytimes he worked outdoors and nighttimes indoors, sometimes shooting around the clock. As a sequel to that expedition, Richie received a cable one morning from the King of Arabia asking him to come over and make some portraits as quickly as possible. Richie and his office—which occupies an entire floor in a Manhattan building—dropped everything, and 24 hours later he was off on a plane for Jidda with \$900 in excess baggage consisting of cameras, film and 5,000-watt spotlights.

Richie made \$7,500 worth of portraits in black and white and in color of the King and his court. Then to save the \$900 for excess baggage on the return trip he sold all his heavy equipment to the Arabian American Oil Co.'s film department.

Despite the Scotch in his blood, Richie's thyroid is not stimulated solely by the clink of one coin against another. Only a man's love for his work would make him so willing to risk his life to catch just the right angle for a shot.

How to Shred a Photographer

In British Columbia, for example, Richie was filming a machine that chewed up big logs in a matter of seconds. The view from the top of the chute where the logs dropped in was fair, but not quite what he wanted. If he could only get a real close-up of the knives that tore the wood to shreds . . .

Richie grabbed a small movie camera, ordered two of the huskiest assistants to hold him by the legs and lower him down the chute. Then, his finger on the camera button, he gave the order and a half-ton log shot down the chute a few inches from his stomach and into the whirling knives. To the company official who called him crazy when he heard of the exploit, Richie replied casually: "I had it set so I'd go head first if anything gave way." END

UNCLE WALTER

IT SMELLS GRAND



HAS IT GOT AROMA?
MAN, AND HOW!

IT PACKS RIGHT



AND IT PACKS SO NEAT
IT RATES A BOW

IT SMOKES SWEET



IT'S THE PIPE-BLEND CHAMP
YOU MUST ALLOW

IT CAN'T BITE!

A BLEND OF CHOICE KENTUCKY BURLEYS,
EXTRA-AGED TO GUARD AGAINST TONGUE
BITE. SIR WALTER RALEIGH STAYS LIT
TO THE LAST PUFF — NEVER LEAVES A
SOGGY HEEL.

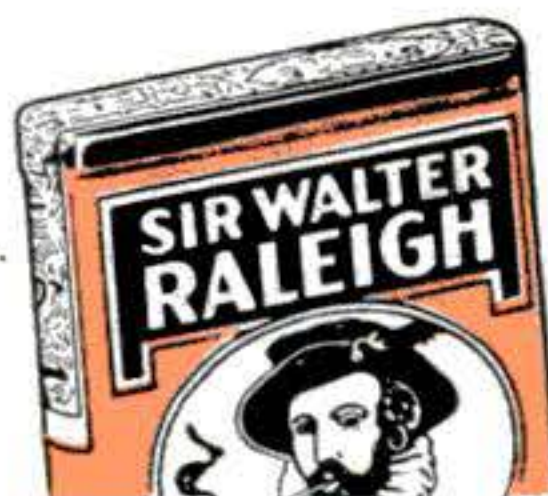

*It costs
no more
to get
the best!*

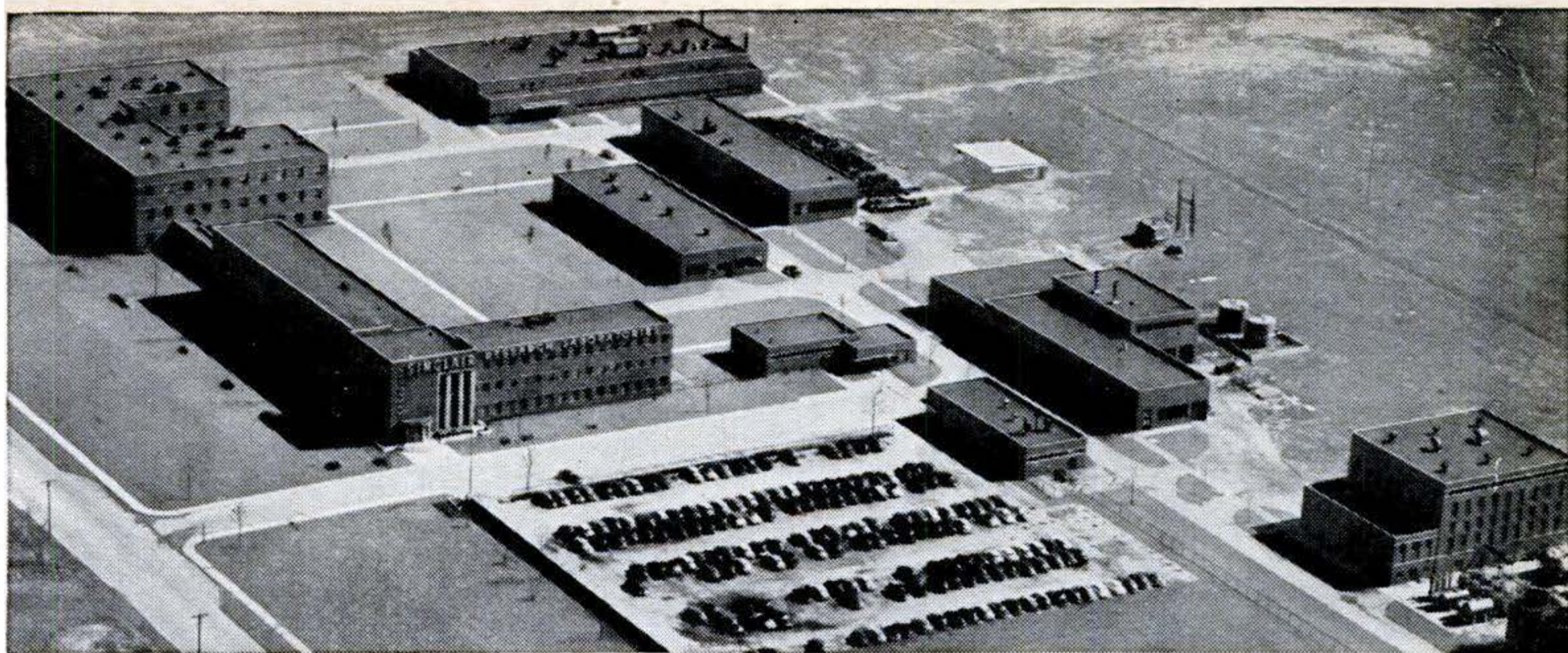

SINCLAIR RESEARCH LABORATORIES—nine buildings containing the most modern testing equipment known—have contributed many of today's most important developments in petroleum products, production and

refining. Under the Sinclair Plan, the available capacity of these great laboratories is being turned over to work on the promising ideas of independent inventors who have no such facilities within their reach.

An Offer of Research Facilities To Inventive Americans Who Need Them

The Sinclair Plan is opening up the Company's great laboratories to every American who has an idea for a better petroleum product

INVENTIVE Americans are often at a loss today. Not because of any lack of ideas, but because of a need for large and expensive facilities to find out if and how their ideas work.

This was no obstacle in our earlier days. The Wright Brothers designed their first airplane with the help of a foot-square homemade "wind box"—and the plane flew.

In contrast, the man with a new idea in airplane design today often needs a supersonic wind tunnel costing millions.

In short, science and invention have become so complex that a man with an idea for a better product often needs the assistance of an army of specialists and millions worth of equipment to prove his idea has value.

Within the petroleum field, the Sinclair Plan now offers to provide that assistance.

Under this Plan, Sinclair is opening up its great research laboratories at Harvey, Illinois, to independent inventors who have sufficiently good ideas for better petroleum products or for new applications of petroleum products.

If you have an idea of this kind, you are invited to submit it to the Sinclair Research Laboratories, with the provision that each idea must first be protected, in your own interest, by a patent application, or a patent.

The inventor's idea remains his own property

If the directors of the laboratories select your idea for development, they will make, in most cases, a very simple arrangement with you: In return for the laboratories'

investment of time, facilities, money and personnel, Sinclair will receive the privilege of using the idea for its own companies, free from royalties. This in no way hinders the inventor from selling his idea to any of the hundreds of other oil companies for whatever he can get. Under the Plan, Sinclair has *no control* over the inventor's sale of his idea to others, and has *no participation* in any of the inventor's profits through such dealings. Moreover, it is a competitive characteristic of the oil business that the new products adopted by one company are almost invariably adopted by the whole industry. This means that the very fact of his agreement with Sinclair should open up to the inventor commercial opportunities which might otherwise be hard to find.

How to proceed: Instructions on how to submit ideas under the Sinclair Plan are contained in an Inventor's Booklet available on request. Write to: W. M. Flowers, Executive Vice-President, Sinclair Research Laboratories, Inc., 600 Fifth Avenue, New York 20, N. Y. for your copy.

IMPORTANT: *Please do not send in any ideas until you have sent for and received the instructions.*

SINCLAIR

A Great Name in Oil

JANUARY 1952 233

Alan Ladd

FAMOUS SCREEN STAR

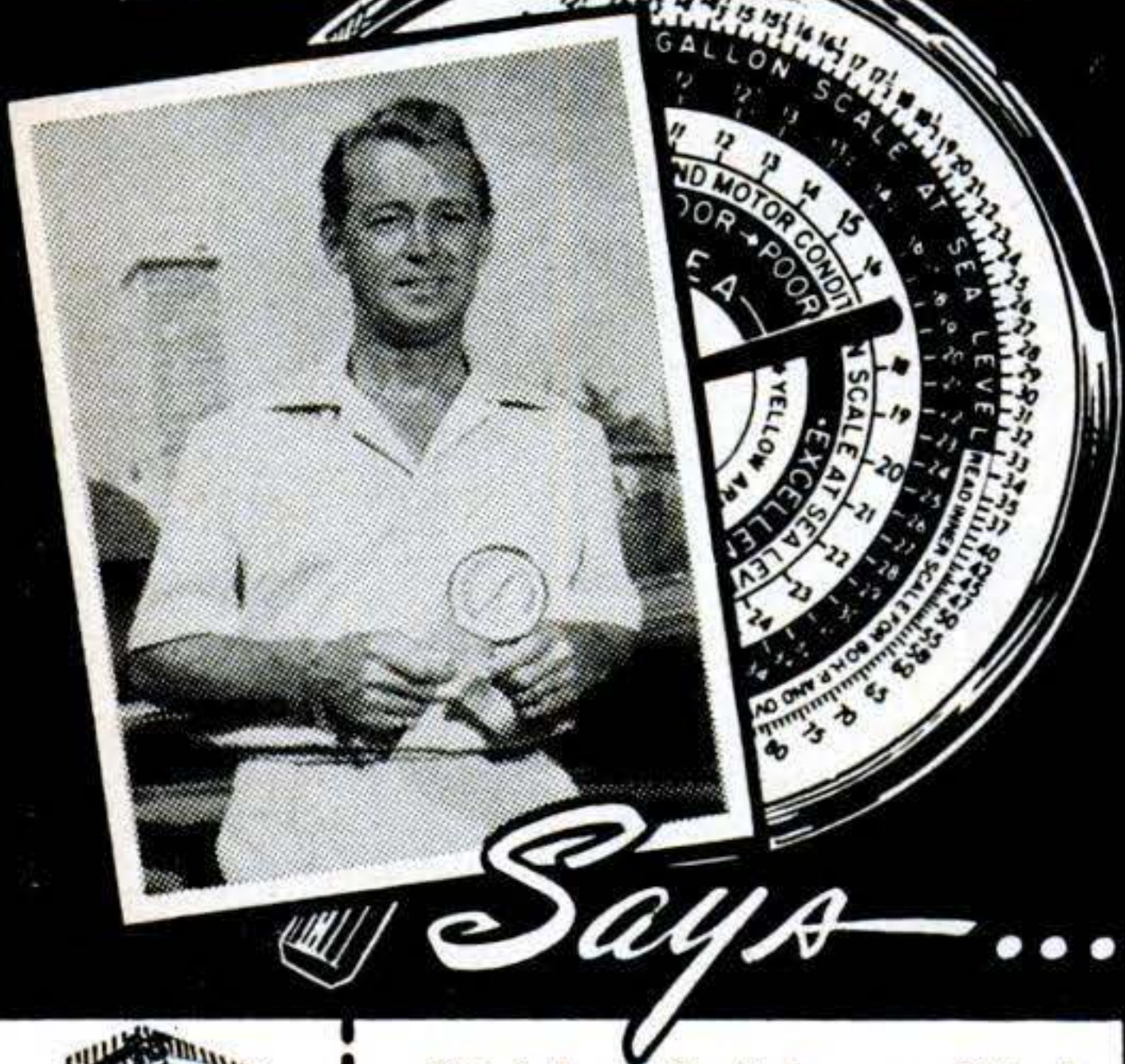

Each "Mile-O-Meter" is beautifully gift wrapped.



24 page instruction manual and Scientific Calculator included.



Precision built by Gauge Craftsmen.

"Out here in L.A. everything's so spread out that we seem to spend half our lives in the car, and it gets mighty expensive.

I sure was thrilled to find this "Mile-O-Meter", a gauge to measure miles per gallon and motor tune-up of our auto. Also checks spark plugs, carburetor and 31 motor adjustments."

Why not follow Alan Ladd, and purchase a "Mile-O-Meter" today. No car is complete without one — shows you how to save gas and check your entire engine. Simple to install — no experience necessary. 4 color dial — a precision instrument.

Guaranteed for 100,000 miles. "Mile-O-Meter" pays for itself in a short time.

The most important new meter in America — Standard the World over — order this mechanical brain today!

DELUXE CHROME MODEL 3 1/4" Dia. \$14.95 Ppd.
STANDARD MODEL 2 1/4" Dia. \$ 9.75 Ppd.

(Both include Fed. Tax)

MAIL THIS COUPON—TODAY!

order from **GALE HALL Engineering** Dept.
107 Northampton St., Boston 18, Mass. 53

Please send DELUXE STANDARD Mile-O-Meters at \$ _____

NAME _____

ADDRESS _____

CITY _____ ZONE _____ STATE _____

Check enclosed COD Gift Wrapped (Free)

Makes a perfect gift. **MONEY BACK GUARANTEE**

Jackpots in Suggestion Boxes

[Continued from page 127]

General Motors alone has paid out \$6,366,198 in prizes since 1942. No less than 775 employees took home the company's top cash award of \$1,000. Recently the top was shoved up to \$2,500 and five people have won it so far. In 10 years GM employees have submitted 704,797 suggestions, and 159,220 of these won prizes and were put into operation.

Government also is a big operator in the suggestion business. The Navy and Army Ordnance suggestion systems date back to World War I. Although the law extending the practice to all Federal agencies was not passed until 1946, the Budget Bureau estimates that the savings to the Federal Government from employee ideas have exceeded \$50,000,000 in the last three years. The Navy claims to have saved \$66,000,000 in two years' operation of its system during the last war, and the Army \$100,000,000!

Idea Saves Navy \$23,000,000

One suggestion alone saved \$23,000,000 in the first year by cutting the cost of fuses for 40-mm. shells from \$1.26 to 37 cents. It earned \$5,550 for the suggester, Raymond L. Graumann, a civilian engineer at the Washington Navy Yard.

Suggestion systems are spreading rapidly to other countries. A Swedish delegation brought here by the U.S. Economic Cooperation Administration recently conducted a study of American methods. Many Canadian companies have suggestion organizations. Canadian Westinghouse has given out nearly \$100,000 in the last eight years on more than 6,500 suggestions.

Diemaker's Invention Saves Time

A 37-year-old diemaker at Canadian Westinghouse named Joe Orme caused a mild sensation not long ago with a small drill he had developed and then carried around in his toolbox, almost forgotten. One day Jim was asked to repair a die that would probably suffer severe damage if the ordinary annealing process were used. He tried his drill, and in a matter of minutes it did a job that would ordinarily have taken hours—if it could have been done at all.

After a dozen demonstrations, Jim decided the drill was worth reporting to the company's suggestion committee. "One of my pals got \$50 for an idea," he explained,

[Continued on page 236]

Popular Files for the Home Workshop



Any reasonable poll or survey will show Nicholson and Black Diamond files the first choice among top mechanics. You'll find these world-famous files in pattern, toolmakers and fine-instrument shops—where precision filing is highly essential. . . . In industrial plants where fast filing is a production "must." . . . In home workshops where fine tools as well as fine accomplishments are owners' pride.

Whatever the requirement, the superiority of Nicholson and Black Diamond files shows up in results—through correct design, accurate cut, proper hardening, uniformity, and maximum wear. Shown here are some of the types most widely carried by hardware and industrial supply houses in popular lengths and range of coarseness. They represent a practical home workshop assortment toward having on hand The right file for the job, saving time and materials, and improving work.

- (1) **MILL** — for smoothing, edge-sharpening, large-tooth-saw filing.
- (2) **TAPER** — Regular, Slim, Extra Slim, Double Extra Slim — for small-tooth-saw and other delicate filing.
- (3) **FLAT** (4) **HALF ROUND** (5) **ROUND** (6) **SQUARE** (7) **PILLAR** (8) **KNIFE** (9) **THREE SQUARE**. Mostly double-cut — for fast stock removal.
- (10) **WOOD RASP** — flat and half round types, for woodworking.
- (11) **SHOE RASP** — with many uses, on wood, metal, plastics, etc., as well as leather. Half round; half of each side rasp cut, other half file cut.
- (12) **HANDY FILE** — with forged-on handle; two types of cut — single on one side, double on other.

FREE BOOK, "File Philosophy," on kinds, use and care of files . . . 48 interesting, illustrated pages. Write to —

NICHOLSON FILE CO.
19 Acorn St., Providence 1, R. I.
(In Canada, Port Hope, Ont.)

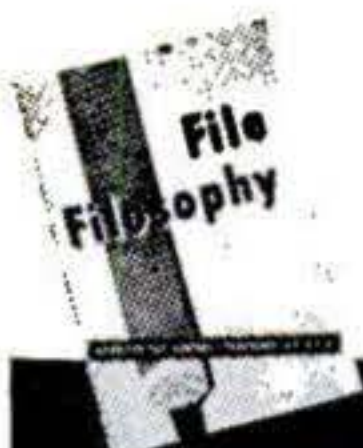

NICHOLSON
FILES FOR EVERY PURPOSE

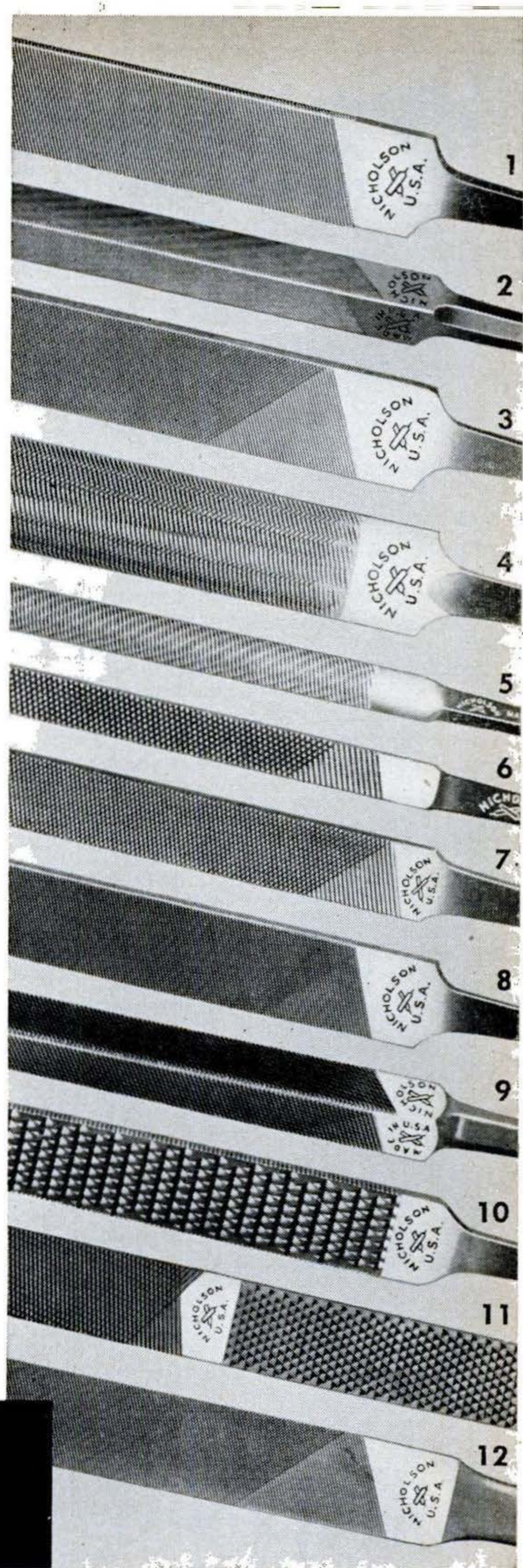



Take advantage of
your **HOME-UTILITY**
Tool's amazing
versatility!

buy
HOME-UTILITY
accessories

RECEIVE a Black & Decker Home-Utility Drill or Sander-Polisher for Christmas? Pleased as punch with the way it helps you build and repair things? Then you're in for more good news when you discover how many more times useful you can make it by buying Home-Utility accessories! There's a whole raft of them to choose from—for everything from sharpening knives and making picture frames to polishing your car and shining up pots and pans. Try them at your hardware, appliance or department store!

Disc Sanding Table
only \$7.75

Ideal for rapid, accurate sanding of picture molding, plastics and hobby parts. Easily handles small, odd-shaped, curved pieces.

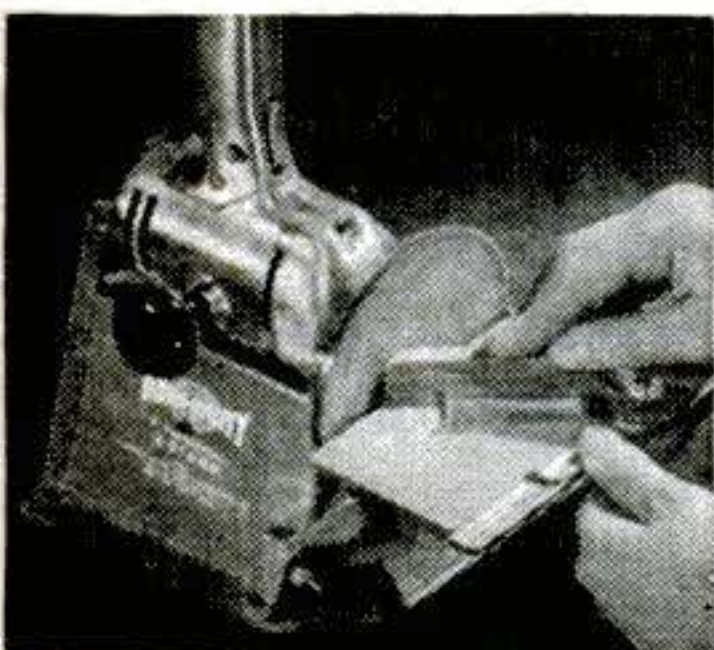

Roto-Hone Attachment only \$10.95

Hones knives, chisels, plane bits, lathe tools to razor edge. Clamp and guide bar for accurate angle. Stone has rough and fine sides.

PLUS stands, auger bits, masonry bits, counter-sinks, wire wheel and cup brushes, sanding discs, lambswool bonnets, auto polish, electric wax, saw blades, protractors, etc. **THE BLACK & DECKER MFG. Co., Dept. H1S, Towson 4, Md.**

BLACK & DECKER

ELECTRIC
HOME-UTILITY
TOOLS

DRILLS • SANDER-POLISHERS • LECTRO-SAWS

Jackpots in Suggestion Boxes

[Continued from page 234]

"and I thought I might make a few bucks too." The committee awarded Jim \$850.

So widespread have suggestion systems become that a National Association of Suggestion Systems has sprung up which already has 475 members. It issues a publication devoted largely to suggestions for getting suggestions.

Most companies pay off on a basis of 10 to 50 percent of the savings made in the first year's operation of the new suggestion. And most of them continue to pay off on the savings of succeeding years.

Some Companies Pay in Merchandise

Some set a maximum—usually \$1,000—on the theory that a set amount is a better incentive than a nebulous percentage of unknown future proceeds. Minimums usually run between \$5 and \$25. A few companies pay off in stock, some use merchandise awards. Many hold contests in which they give out radios, refrigerators and even automobiles.

Big companies have made it so easy to turn in ideas that most employees find it hard to resist. Suggestion forms are provided, and about all you have to do is fill in the blanks. Most companies require that the suggestion tell not only what is to be done but also give a reasonable description of how to do it.

Appearances Don't Count

"Don't worry about spelling, grammar, punctuation or appearance," says the General Motors employee-suggestion manual. "All that counts is the idea."

Committee representatives pick up the suggestions regularly, notify the sender that his idea is in the works and send it along to a committee of specialists—representatives of management, engineering, tool design, cost accounting and manufacturing.

These committees, in the words of one company, "lean over backwards to see that every suggestion receives unbiased treatment." They are usually looking for points in favor of each suggestion, not trying to knock it down.

"We're just as anxious to pay awards as you are to get them," one company assures its employees.

END

Next Month: POPULAR SCIENCE brings you the story of the man who invented a way for you to make money.

A NEW THRILL for Home Builders...

HEATHKITS

PROFESSIONAL QUALITY
RADIO and LABORATORY
INSTRUMENTS IN KIT FORM

Heathkit 5"

OSCILLOSCOPE KIT

A laboratory quality oscilloscope 5" cathode-ray tube — every part supplied including instructions for operation and assembly. Includes ten tubes — all controls — high gain .03 Volt RMS per inch vertical sensitivity useful to 5 Mc. An outstanding buy. Shipping weight, 29 lbs. — Model O-7

\$43.50

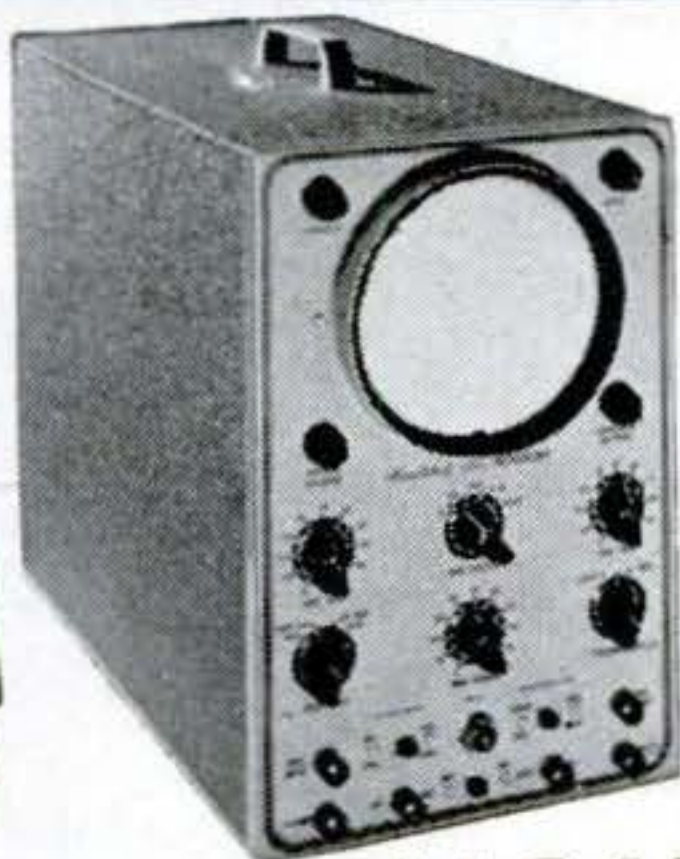

Heathkit VACUUM TUBE VOLTMETER KIT

A complete electronic voltmeter in kit form. All parts supplied: cabinet, 200 microampere 4 1/2" meter, tubes, test leads and instructions. Has 11 megohm DC input resistance. Measures full scale voltages AC and DC of 0 - 3 - 10 - 30 - 100 - 300 - 1000 Volts and resistance between 1/2 ohm and one billion ohms. The outstanding VTVM available today. Shipping weight, 7 lbs. — Model V-5.

\$24.50



Heathkit SUPERHETERODYNE RECEIVER KIT

A high quality AC operated superheterodyne receiver in kit form. Complete with five tubes — six inch slide rule dial — all coils — transformers and ready punched chassis and instructions. Learn about radio by building this outstanding receiver.

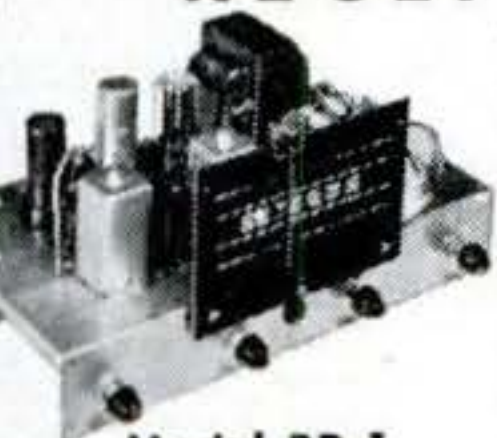

Model BR-1
Shipping Wt. 11 lbs.

\$19.50

Heathkit 6 WATT ECONOMY AMPLIFIER KIT

A powerful 6 watt amplifier kit. Complete with tubes — transformers and all parts. Use it for music reproduction — public address system — factory call — school dances, etc. Easily assembled. Rent it in your community and it will quickly pay for itself.



Model A-4
Shipping Wt. 8 lbs.

\$12.50

SAVE
2/3 THE
COST

GAIN
VALUABLE
KNOWLEDGE

HAVE
A COMPLETE
LABORATORY
FOR A FEW
HUNDRED DOLLARS

BUILD
OSCILLOSCOPES
V.T. VOLTMETERS
SIGNAL
GENERATORS
AMPLIFIERS ...
BRIDGES and 20
Other Instruments



Easy STEP BY STEP INSTRUCTIONS WITH PICTORIAL DIAGRAMS...
MAKE ASSEMBLY EASY FOR ANYONE.
All metal parts ready punched. Only pliers, screwdriver and soldering iron
needed for assembly.

ORDER TODAY
OR WRITE FOR
CATALOG ...

HEATH COMPANY

BENTON HARBOR 16,
MICHIGAN

First for fine work!

There's one point on which all mechanics agree—Stanley Tools are first for fine work. That's why you'll see these Stanley Tools in the tool chests of skilled woodworkers everywhere. Accuracy and easy action make these tools perfect partners for fine workmanship. Look for this famous **STANLEY** at your hardware dealer's. It's the sign of top quality tools.

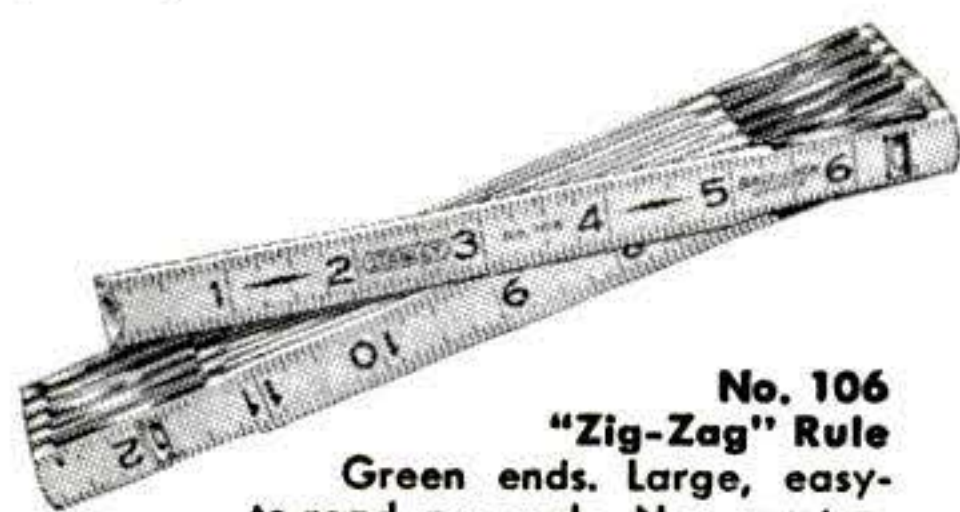

No. 106 "Zig-Zag" Rule
Green ends. Large, easy-to-read numerals. New protective plastic finish. 6' and 8' sizes.

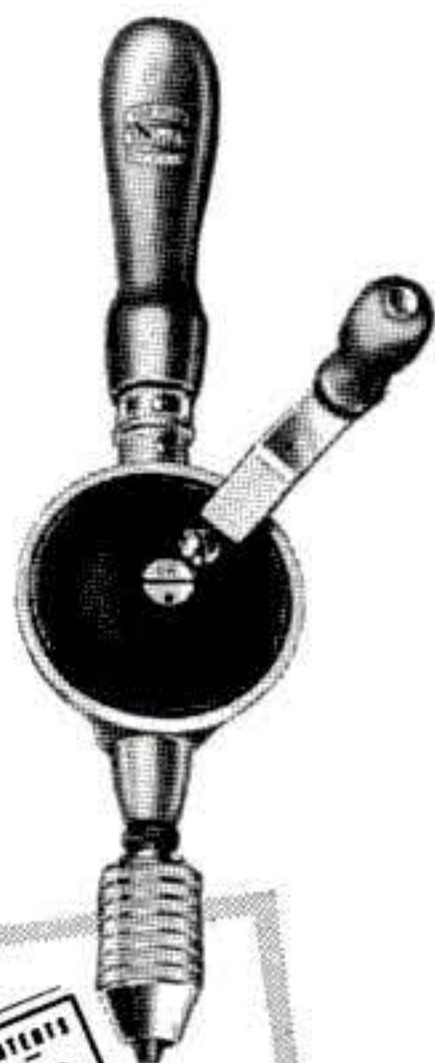

No. 610 Hand Drill. New! Enclosed gears for safety. Drills holes easier, faster to full $\frac{1}{4}$ " capacity.

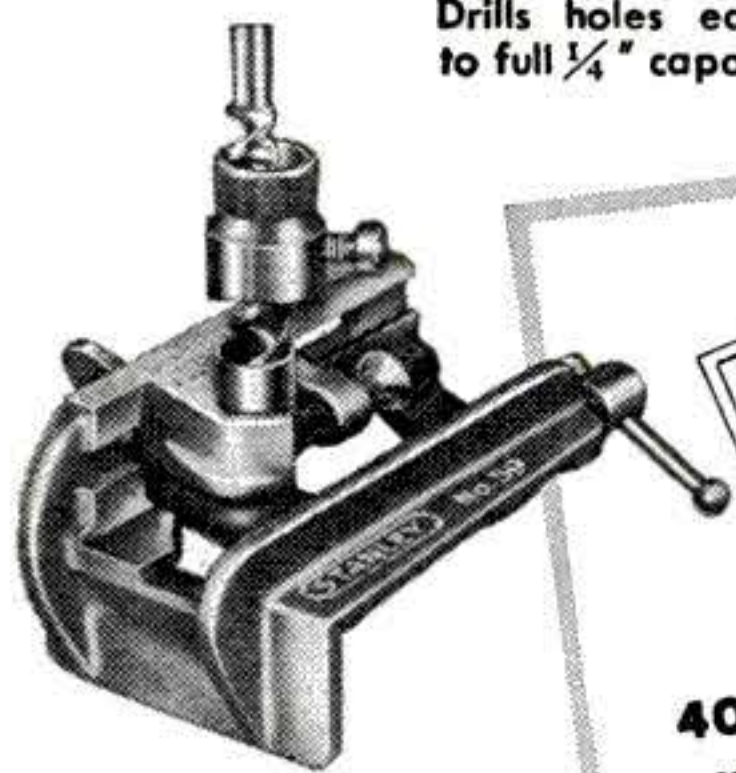

No. 59 Doweling Jig
For boring holes accurately and easily in the edge, end or surface of boards. Furnished with depth gauge and six guides — $\frac{3}{16}$, $\frac{1}{4}$, $\frac{5}{16}$, $\frac{3}{8}$, $\frac{7}{16}$, $\frac{1}{2}$ ".



40 PAGES OF TOOL "KNOW HOW"...
only 25c

Stanley Tool Guide contains full information on how to use all common hand tools. Invaluable to beginners, helpful to experienced craftsmen. Send for your copy with coupon below.

Stanley Tools,
New Britain, Conn.

The Tool Box of The World



HARDWARE • TOOLS
ELECTRIC TOOLS
STEEL STRAPPING • STEEL

SEND STANLEY TOOL GUIDE

Stanley Tool, 412 Elm St., New Britain, Conn.
(In Canada: Stanley Tool Co. of Canada, Ltd.,
412 Stanley St., Roxton Pond, Quebec)

Send me..... Stanley Tool Guide.
Enclosed is 25c per copy.

Name.....

Address.....

City..... State.....

How a One-Armed Bandit Works

[Continued from page 93]

slot machines. On the basis of Federal tax returns, it is estimated that more than 200,000 slots were operating in 1949. Each of these made a profit of perhaps \$50 a week, or around \$2,600 a year. That would make a gross profit for the industry that year of about \$520,000,000. Figuring that there were many more machines whose operators paid no tax, the California Crime Study Commission set the national gross at two billion a year. That allows a very tidy profit, when you remember that slot machines are illegal in 43 of the 48 states.

Profits Pay for Bribes

How do the 175-odd distributors and 10,000 operators who compose the slot-machine industry get away with it? Some slots of course are in clubs or private homes where police are loath to interfere. But most slots get by for two reasons: a community is either indifferent or thinks that slots bring business; or local officials or police are bribed to ignore the machines. Experts of the California Crime Study Commission figure that 10 to 20 percent of the gross profits go to corrupt law enforcement.

But times are changing. In Idaho, for example, which had passed an act legalizing slot machines on a local-option basis, several cities revoked all licenses after a couple of years' trial. The city commission of one of these communities, Twin Falls, is described in testimony before a Congressional committee as reporting that licensed slot machines resulted in an increase of armed robberies and a rise in relief applicants.

Can't Gamble to Prosperity

As an added argument, Twin Falls businessmen are said to have reported an increase in overdue accounts. In 1949, Governor C. A. Robins asked the legislature to repeal the license law, stating that "Idaho cannot gamble itself into prosperity."

Lately many communities and states have been cracking down. Wisconsin and Minnesota, notably, have passed new statutes credited with putting the one-armed bandits out of business. And Uncle Sam has gotten into the act with passage of a Federal law that forbids interstate shipment of slot machines or parts except to the few states where they are legal. Several manufacturers are reported going out of business or turning to legal vending machines. **END**

SAVE ON THESE
BRAND NEW

WAR SURPLUS SPECIALS

UNCONDITIONALLY
GUARANTEED

HEAVY DUTY—AIRCRAFT QUALITY HYDRAULIC EQUIPMENT

Large supply of new labor-saving, economical hydraulic equipment in many types and sizes. Use these positive, highly efficient smooth pressure hydraulics on presses, arbors, lifts, loaders, power control, positioning, brakes, plastic dies, auto frame alignment, etc., etc.

ITEM #127—Double acting hydraulic cylinder, 1" bore, 1" stroke, 1/2" diam. shaft, 1/4" tubing thread ports. Over-all length closed—6 1/2". Clevis mounting at both ends. Perfect for clamping and feeding. **Postpaid... 5.95**

ITEM #29 KJ—GEAR TYPE HYDRAULIC PUMP. Ideal in Industrial Applications and for operating all hydraulically powered farm implements, including loaders, stackers, swathers, plows, etc. Delivers 1,000 PSI, (may be set at lower PSI if desired) 12 GPM @ 400 RPM. Maximum operating speed 800 RPM—rotation counter clockwise. Has built in relief valve, permanent or torque bar mounting, 1" diam. shaft, 3/4" pipe tap inlet, 1/2" pipe tap outlet. Shipping weight 22 lbs. F.O.B. Chicago... **45.50**

ITEM #16 C—Double acting hydraulic cylinder, 1 1/2" bore, 26" stroke. Will lift 1760 lbs. with 1000 PSI line pressure. Weight 8 lbs. A **16.95** \$55.00 value. Now Only, **Postpaid...**

Item #126—Four-way, open center control valve with built-in adjustable relief valve. Factory set at 1000 PSI., spring-loaded neutral position for use with one double-acting cylinder. Fully balanced plunger type, smooth, positive, easy operation, can be used as single unit or mounted in series of any combinations desired. Has 3/4" pipe thread inlet and outlet, 1/2" pipe thread cylinder ports. Newly manufactured to our specifications. Shipping weight 8 1/4 lbs. An outstanding **21.50** Buy! F.O.B. Chicago

ITEM #103—Double acting hydraulic cylinder, 2 1/2" bore, 17" stroke. Clevis mounting. Will lift 4900 lbs. with 1000 PSI line pressure. 1 1/4" diam. shaft, 3/8" tubing thread ports. Overall length closed 28". Shpg. wt. 11 lbs. F.O.B. Chicago... **21.50**

ITEM #6—Double action hydraulic cylinder, 3" bore, 24" stroke, will lift 7070 lbs. with 1000 PSI line pressure. Steel barrel, 1 1/4" stainless steel shaft. Gov't. acq. cost. \$176.00. Shpg. wt. 26 lbs. F.O.B. Chicago... **28.00**

ITEM #42—Double action hydraulic cylinder, 4" bore, 18" stroke. Rated lift capacity with 1000 PSI line pressure is 12,500 lbs. Ship. wt. 30 lbs. F.O.B. Chicago. An Excellent **32.50** Buy for...

General Motors — Allison CENTRIFUGAL PUMP

BRAND NEW



(Item #130)

200 GALLONS PER MINUTE

- For Draining Basements • Fire-Fighting
- Irrigation • Fuel Transfer • Swimming Pools • Home Water Systems • Dewatering

This General Motors-Allison Centrifugal Pump—designed for use on U. S. Air Force Mustang fighters, now converted for commercial, home, and industrial high volume pumping applications. Inlet, 2 1/2" standard pipe thread, twin outlets with 1 1/4" pipe thread, ball bearing supported 3/4" shaft. Easy, fast simple priming. Rotation, counter-clockwise facing shaft. Shipping wt. 35 lbs. Gov't acq. cost \$145.00. **39.50** F.O.B. Chgo.

NOW ONLY

Suction Lift	Head Pressure	Gal. Per Min.	H.P.	R.P.M.
10'	75'	260	6.0	3500
10'	65'	200	5.2	3500
10'	80'	40	1.5	2500
10'	50'	140	5.0	3500
10'	30'	100	3.0	2500

PREPARE NOW FOR POWER FAILURE! Immediate Delivery — Large Stock — Many Sizes GENERATING PLANTS

DESIGNED FOR CONTINUOUS OR INTERMITTENT SERVICE

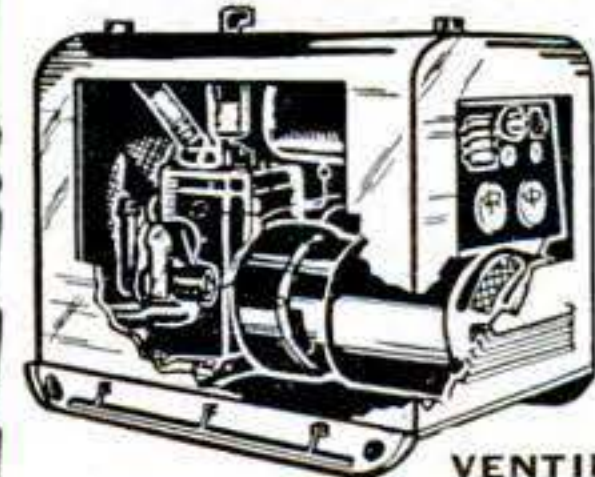

ITEM #133
LIGHTING • OTHER APPLIANCES
Item #133—3 KW—120 Volt—60 Cycle A.C. Single Phase HEAVY DUTY

Totally enclosed power unit with 2 cylinder water-cooled Hercules Model BXB engine direct coupled to generator. Magneto ignition, crank start, 4 gallon gas tank, 3 qt. oil capacity. Skid mounted with handrails for carrying. Instrument panel including killer button, oil pressure, water temp. gauges, voltmeter, ammeter. Shipping wt. 560 lbs. F.O.B. Chicago... **395.00**

Item #178—350 watt—110 volt—60 cycle A.C. direct coupled to 1 cylinder Midco engine. Shpg. Wt. 116 lbs. F.O.B. Chicago... **125.00**

Item #182—Onan Generator—5KW—120/240 volt—60 cycle A.C. single phase, direct coupled to Willy's Jeep 4 cylinder, water cooled engine with push button start, battery ignition. (Battery not included.) Shpg. Wt. 1200 lbs. F.O.B. Chicago... **795.00**

Item #201—PE 95-G—10 KW—110/220 Volt—60 Cycle A.C.—Single Phase. Totally enclosed, Onan generator direct coupled to Willys Jeep, 4 cylinder, water cooled engine, push button start. Instrument panel with engine and generator instruments, circuit breaker, controls, etc. Uses 6 volt car battery. (Battery not included) Skid mounted. Shipping weight 1500 lbs. F.O.B. Chicago... **1295.00**

Item #180—15 KW—127/220 volt—60 cycle AC—3 phase 1800 RPM. Brance & Krachy Generator direct coupled to International Harvester 4 cylinder, water cooled engine with magneto ignition—push button start. Panel has voltmeter, ammeter, 4 wire electrical system, belt driven excitor generator, rheostat

voltage control. Engine and generator mounted on steel skids. Shipping weight 2000 lbs. F.O.B. Chicago... **1650.00**

Item #128—25 KVA—250 volt, 3 phase—120 volt, Single phase—60 cycle. Totally enclosed-Hobart generator driven by a GMC 270. 6 cylinder gas engine, button start, liquid cooled. Has control panel with full set of instruments for both engine and generator. Shipping weight 2600 lbs. F.O.B. Chicago... **2250.00**

Write for information on other size generating plants ranging from 350 watts to 25 KVA.

FREE: NEW 1952, 48-PAGE CATALOG

New Model 353—Dual Range ARC WELDER

for Stationary or Portable Use
HEAVY DUTY RANGE TO 250 AMPS.
NEW 'MAGIC TERMINAL'
FOR LOW CURRENT
30 TO 100 AMPS.
IDEAL for:

- FARM • GARAGE
- FACTORY
- WORKSHOP

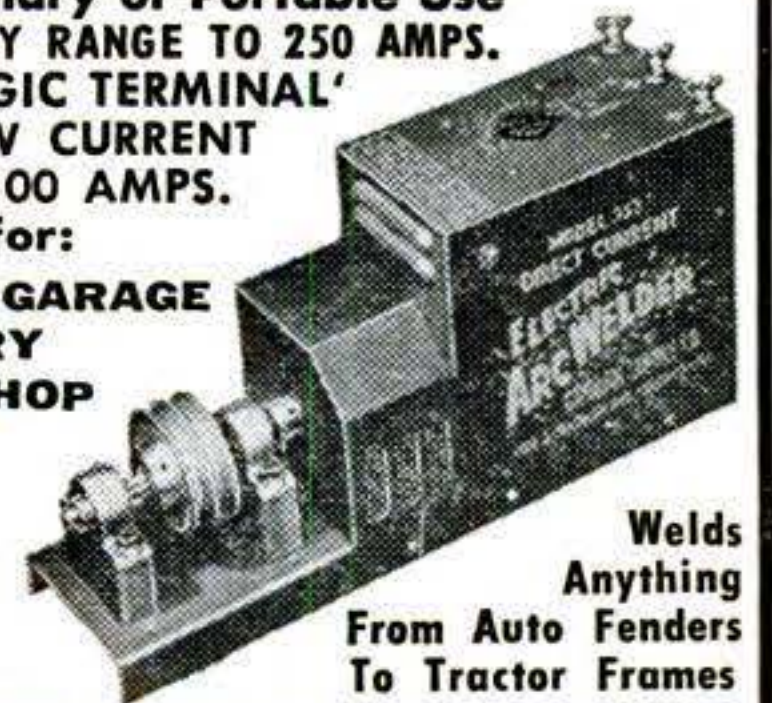

These precision engineered D.C. Arc Welders contain the highest quality War Surplus aircraft components built to exacting government specifications. They are light in weight, have oversized lifetime grease-sealed ball bearings, air cooled commutator, dial type rheostat for easy pin-point control, a high-low rheostat switch, reactor coil for even arc and the new 'MAGIC TERMINAL' low current welding range for welding lighter materials. Designed for many years of trouble-free service. Run welder from drive pulley or power take off of a tractor or Jeep, 7 1/2 HP electric motor or 10 HP gas engine at 2500 R.P.M. Uses two V belts or flat belt. Continuous output rating 200 amps. Intermittent welding rating 250 amps, 30 volts. This sensational price includes double V or flat belt pulley and complete operating instructions. Shipping weight 107 lbs. \$350.00 Value **Item #65** Now Only... **119.50** F.O.B. Chicago

D.C. GENERATORS

For welders, plating, truck and marine use. D. C. appliances, lights, etc. Aircraft quality—lifetime grease sealed ball bearings. Heavy duty.

Item #90—Type P-1, rated 200 Amps.—28 Volts, 2500 RPM. Mfd. by General Electric, Ford, Delco-Remy and Westinghouse. Gov't Acq. Cost \$300.00. Shpg. wt. 53 lbs. F.O.B. Chicago... **22.50**

Item #91—Type R-1, rated 300 Amps.—30 Volts. Mfd. by Jack & Heintz. Gov't Acq. Cost \$380.00. Shpg. wt. 59 lbs. F.O.B. Chicago. Each individually packed in wooden box... **35.00**

HYDRAULIC SPEED REDUCER

WITH FINGERTIP CONTROL
(Item #115)

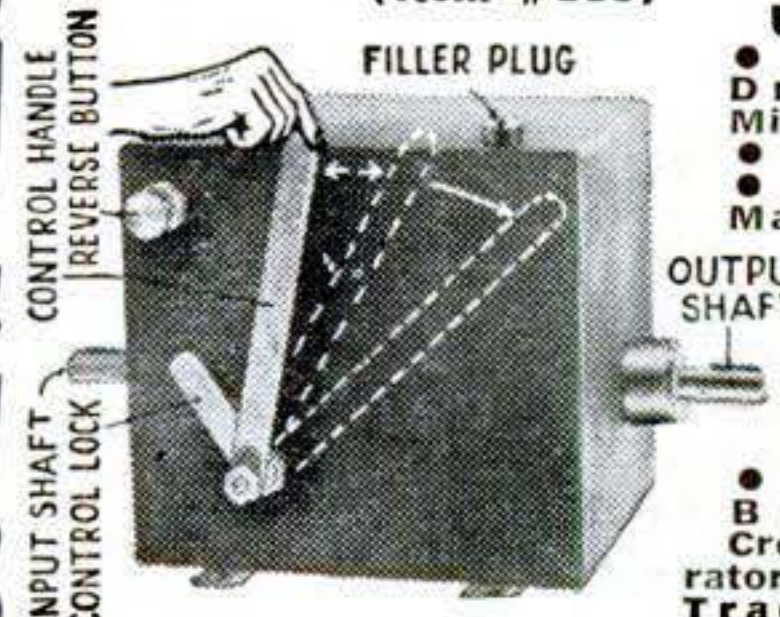

Variable output speeds ranging from 0 to input speed now available. Merely move control handle until desired speed is attained. Then turn locking handle to maintain the setting. Internal relief valves prevent overloading. Use input power of 1/4 to 1 1/2 H.P.

This Westinghouse-Oil Gear Unit converted to commercial use from 40 MM anti-aircraft traversing mechanisms consists of a variable displacement hydraulic pump feeding a fixed displacement hydraulic motor. These components are contained in a crackle-finish steel oil reservoir (capacity 2 qts.). Adjustable relief valves set at factory for 100 inch pounds of torque may be reset up to 180 inch pounds. Independent reverse control allows full output power and speed selection in either direction of rotation. Both input and output shafts measure 5/8" diam., include keyway. Input rotation is counter-clockwise facing shaft. Recommended input speeds not to exceed 750 R.P.M. Over-all dimensions 7 1/2" x 7 1/2" x 11 1/2". Gov't acquisition cost, \$428.00. Shipping weight 31 lbs. Complete with 2 qts. of oil and full instructions. F.O.B. Chicago... **54.50**

ORDER DIRECT FROM AD — SEND PAYMENT OR PURCHASE ORDER TODAY — SATISFACTION GUARANTEED

GROBAN SUPPLY CO. 1139 SO. WABASH AVE., CHICAGO 5, ILL. DEPT. PS-1.

PALMGREN

HOBB-E TOOLS

ANGLE VISE

Set up hard angle jobs in 5 seconds. Drill, grind, mill round, square or irregular pieces quickly and accurately. Save time, money and errors. PALMGREN "Hobb-E" ANGLE VISE has 1½" Jaws, 1 Plain 1 Grooved. Accurately machined and graduated. No. XI only

\$4.95

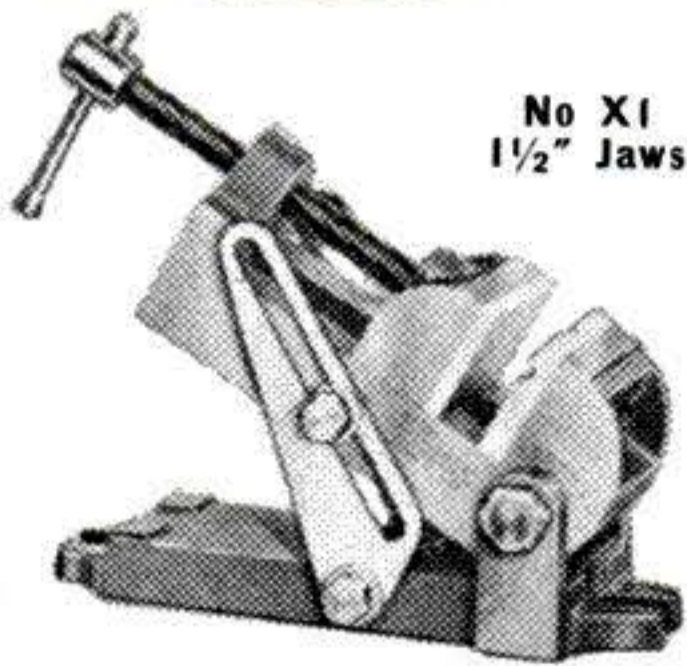

No XI
1½" Jaws

ROTARY INDEX MILLING TABLE

Turn drill press into vertical miller. Mill, Grind, Index Rabbet, Mortise and Rout curved or straight PALMGREN "Hobb-E" ROTARY TABLE is a precision machine, accurately graduated. Bolts to table.

No. 83-8" Table 4"

Cross Feeds, 360° Rotary Feed

\$54.50

No. 82- Without Rotary Feed....

\$43.75

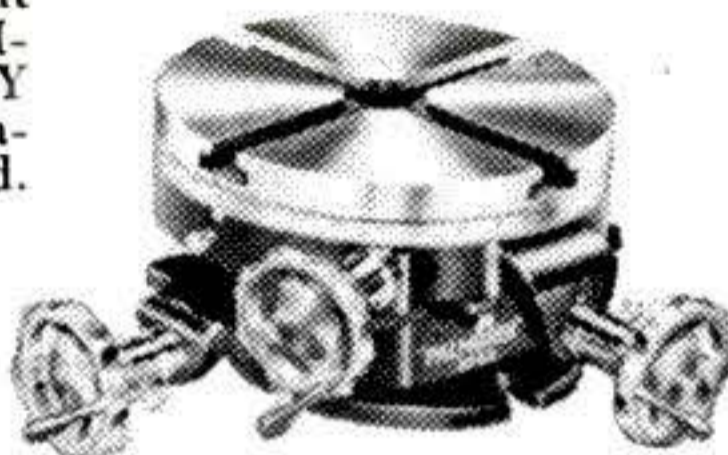

No. 83

ADJUSTABLE ANGLE PLATE

Every Hobbyist should have one for jobs difficult to hold in vise. No delay, less spoilage on complicated angles in drilling, milling, grinding or layout work. No. 256 B has 6" x 6" surface plate, 8 bolt slots. Adjustable to full 90°. Accurate graduations. Swivel Base. Only

\$14.35



No. 256B

BENCH DRILL PRESS VISE

A fine "Hobb-E" tool. Base bolts to work bench for general work. Vise is dovetailed and removable for use on drill press by loosening thumb screw. Unit rotates 360° horizontally. Adapter has steel jib which locks vise in position. No. 12 Removable Jaws 2½" wide. 1 Plain 1 Grooved. Only

\$12.95

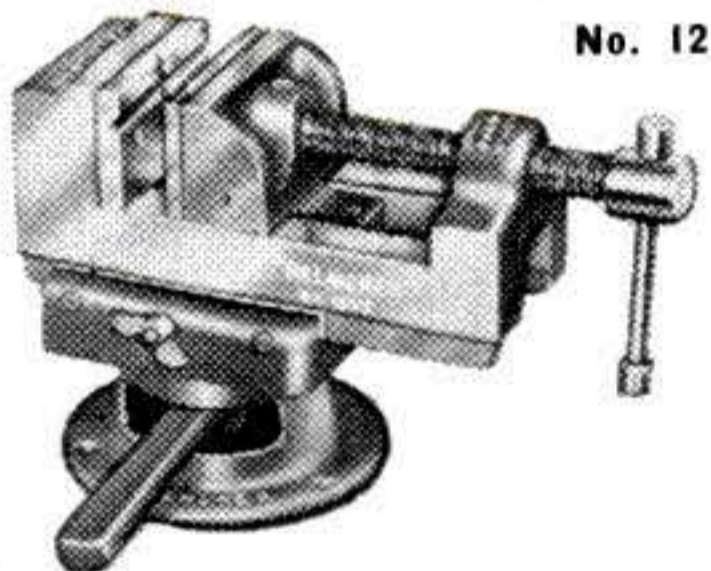

No. 12

ALL PURPOSE ALUMINUM HAND VISE

This "Hobb-E" tool grips small pieces for grinding, buffing and 101 other uses. Safe-guards hands and fingers. Small parts easier and faster to handle with better results. No. 15 Jaws 1½" accurately machined, can't mar work. Only

\$2.15

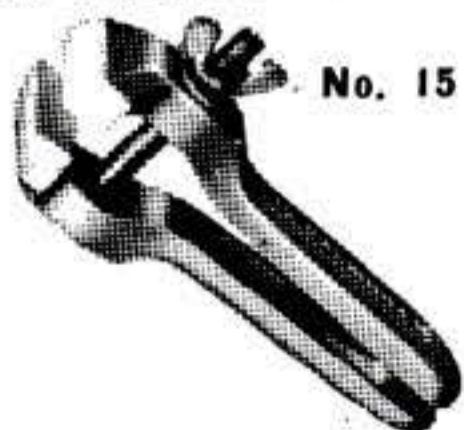

No. 15

ORDER NOW! SEND COUPON TODAY!

CHICAGO TOOL & ENGINEERING CO.,
8397 South Chicago Ave., Chicago 17, Ill.

Enclosed find _____ for items checked below.
 PALMGREN "Hobb-E" ANGLE VISE. PALMGREN "Hobb-E" ANGLE PLATE. PALMGREN "Hobb-E" MILLING TABLE. PALMGREN "Hobb-E" HAND VISE. PALMGREN "Hobb-E" BENCH DRILL PRESS VISE.
 Send Circular.

NAME _____

ADDRESS _____

TOWN _____ ZONE _____ STATE _____

America's New Light Car [Continued from page 120]

Moreover, the type of drive used, the Hotchkiss, transmits propulsive power from the rear wheels through the car springs, instead of through the propeller-shaft housing, the way a torque-tube drive does.

Vibration is inevitable in a car's power train. Variations of engine power cause the pinion gear in the differential to try to climb the ring gear. An oscillation develops around the ring gear's center. The principal reaction points with a Hotchkiss drive—insofar as passenger comfort is concerned—are the front eyes of the rear springs.

Rubber Absorbs Shocks

Willys solved the problem by attaching the spring eyes through live rubber to a "floating" cross member. That, in turn, is mounted in rubber where it attaches to the body. The rubber swallows and digests any shudders before they can reach the seats.

The ride, as the boss man had demanded, was superb. The Aero trod washboard as though it were glass-smooth. The pitch on hard bumps was scarcely noticeable. It took right-angle flat turns at 45 miles an hour without evident sway. That was due to a center of gravity only 23 inches above road level, the lowest of any six-passenger car in its price class.

The braking was exceptional. From an indicated speed of 60, the car came to a full stop in 156 feet. While the brakes were applied hard enough to make the rubber squeal, the shoes did not grab.

The noise level at 75 miles an hour with the vents closed was so low that the driver could hear a passenger in the back seat snapping a cigarette lighter closed. At 10 miles an hour a faint tappet noise did develop. A Willys representative said that was a matter of adjustment.

"Nearest Thing to Flying"

The driver's view of the road was equal to or better than that offered by any other car it has been our pleasure to drive. A low hood helps. Another nice feature is fenders so high that the driver can see all four.

The names that Willys has given two versions of its new car, Aero Ace and Aero Wing, didn't strike us as very imaginative. "Why," we asked Canaday, "the Aero?"

"Because," he countered, "it's the nearest thing to flying you'll find on the highway."

He may have something there! **END**

CHOOSE THE MODEL BEST FOR YOU!

Two DREMEL Electric SANDERS with STRAIGHT LINE Action for Guaranteed SCRATCH-FREE Surfaces

Perfect answers to any sanding problem, both Models feature: Only 2 moving parts; 14,400 strokes per min., easy one-hand operation; dust-proof—foolproof; 10-second paper change; 110-120 V., 60 cycle A.C. PLUS—straight-line action for mirror-smooth finishes. Don't settle for less!

MODEL 2000 FOR HEAVY DUTY CRAFT AND WOODWORKING PROJECTS—Fastest seller in the field for rugged power and smoothest finishes at lowest cost. Ample power for furniture and cabinet making, boat building or refinishing, resurfacing large areas. Great for building operations—woodwork, stairs, dry-wall joints, siding, etc. Does a superb polishing job! Weighs 5 lbs; 21 sq. in. of sanding surface; over-all size 3 1/8" x 4 1/2" x 7". Price includes steel carrying case, 25 ass'd. abrasive sheets, and a sheepskin pad.

MODEL "A" FOR HOBBIES, REFINISHING, REDECORATING—Finest sander ever offered housewives, home-owners, hobbyists. A lighter-capacity model for woodwork, unfinished furniture, hobby shop projects, etc. Wonderful for polishing waxed surfaces. Also a soothing massager! Weighs only 2 1/2 lbs. Sanding pad 2 1/4" x 5 1/2". Price includes 6 sandpapers, 1 sheepskin, 1 felt pad.

MODEL 2000

\$24.50



14,400 SANDING STROKES PER MIN.

MODEL "A" \$14.85

ONLY STRAIGHT-LINE ACTION . . . SANDS WITH THE GRAIN—NEVER MARS OR SCRATCHES

Don't just take our word for it. Ask any professional woodworker about sanding action. He will tell you that only straight-line, with-the-grain sanding can produce a flaw-less finish.

BEFORE YOU BUY ANY SANDER . . . COMPARE!

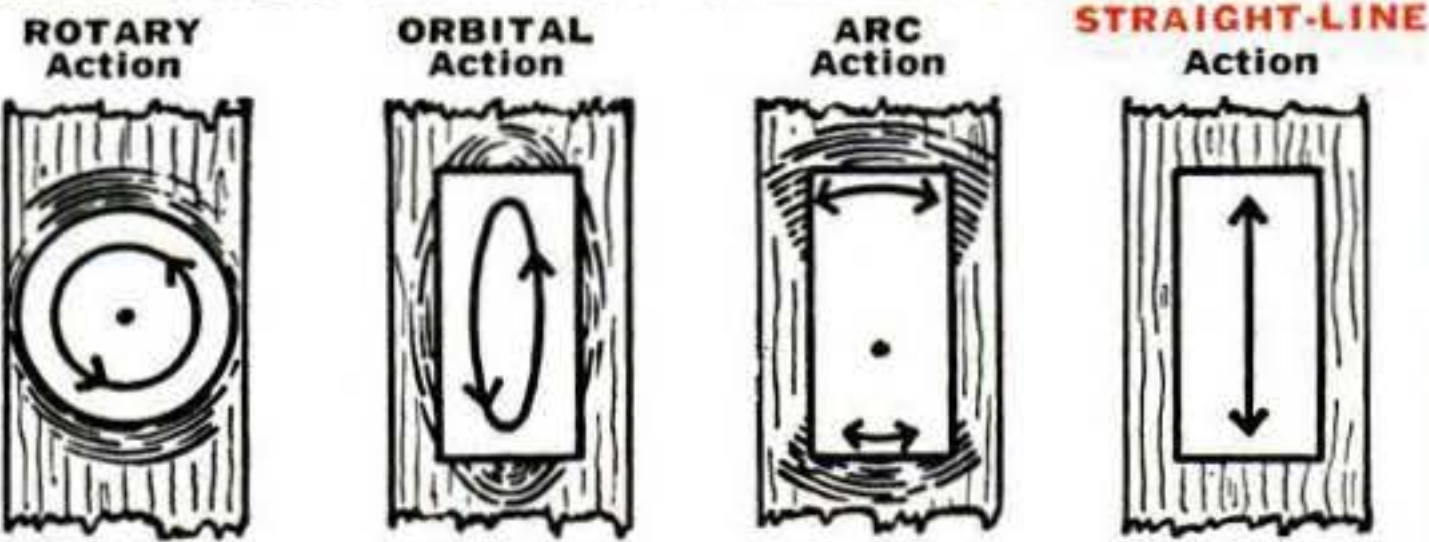

DREMEL Electric COPING SAW

CUTS SCROLLS LIKE MAGIC—SANDS AS IT SAWS

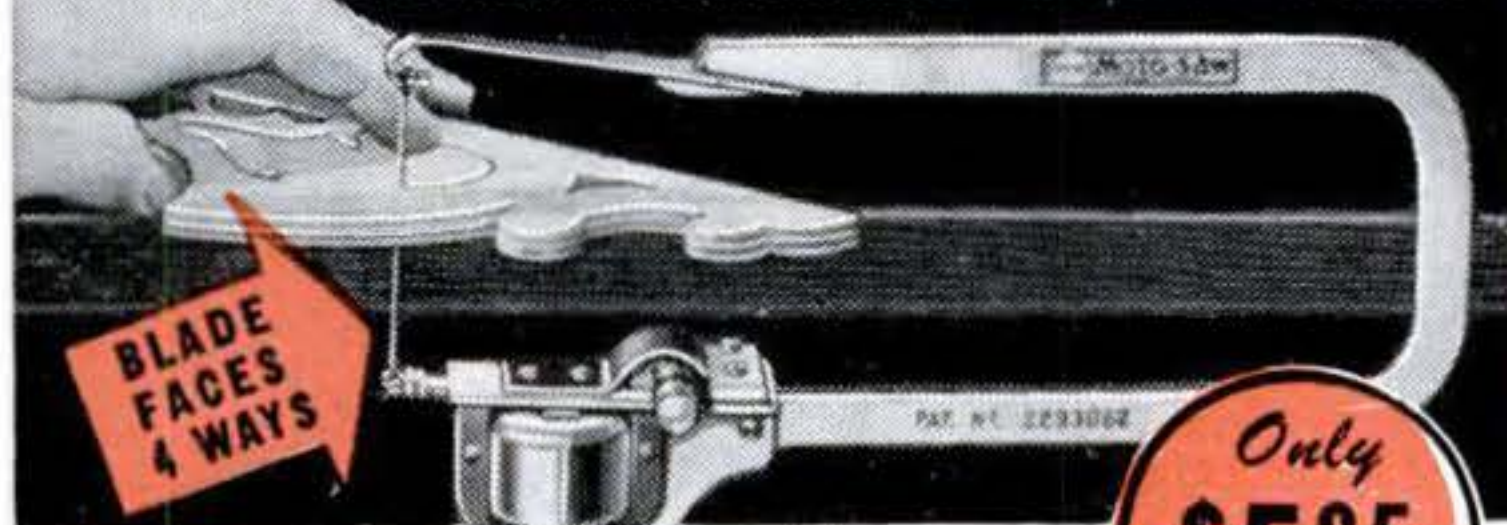

BLADE FACES 4 WAYS

MAKE YOUR OWN JIG SAW PLANS FREE!

JUST GUIDE IT!

Only \$5.85 with 3 saw blades

SAFE! AS A HANDSAW

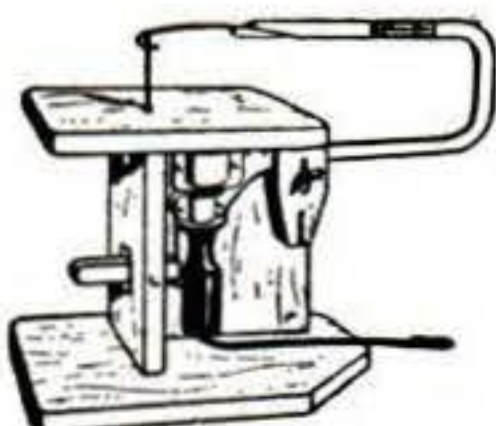

For home, hobby, repair work—no other tool pleases so much for so little cost. Works in any direction—delivers 7,200 strokes per minute smoothly, effortlessly. Saws through 3/4" medium-hard wood at a foot-a-minute speed. Touch-of-the-trigger, foolproof action. Only 2 moving parts, never needs oiling. Uses 110-120 V., A.C. Free plans, packed with each saw, for six useful wood-working projects and for making your own jig saw.

GRINDS • CARVES • ENGRAVES
DRILLS • ROUTS • SHARPENS

DREMEL Electric MOTO-TOOL

FASTEST MOST POWERFUL TOOL In Its Class—Approx. 27,000 R. P. M.

Most practical tool a man can own—more powerful than any similar tool you can buy. Works well in wood, plastics, and metal. For home maintenance jobs you'll wonder how you got along without it. For model making it's a must. And for general shop operations it saves time and money. Compare it, try it, buy it. You be the judge! CHECK THESE IMPORTANT FEATURES—Oilless sealed bearings • Dynamically balanced armature • Shock-proof, Bakelite housing • Dust-filtered air cooling system • Sturdy 110-120 V., A.C.-D.C. motor • Wt. only 13 oz. • A precision tool widely used in industry for many years.



MOTO-TOOL NO. 2 (with 1 emery wheel point)

\$16.50



MOTO-TOOL KIT NO. 2 With 23 Accessories (High-Speed Steel Cutters, Grinding Wheels, Polishers)

\$23.50

You Be The Judge of Dremel Products—Our reputation has been built on results rather than sensational claims. We invite comparison of Dremel tools with any similar products made. Then you'll know why we guarantee the most for your money!



Where To Buy—If your dealer doesn't carry, remit in full for postpaid ship't. Or send only \$2 now, pay postman balance plus postage and COD fee. Five-day trial, money-back guarantee! DREMEL MFG. CO. Dept. 122-A Racine, Wis.

**WHY PUT
UP WITH
THIS**

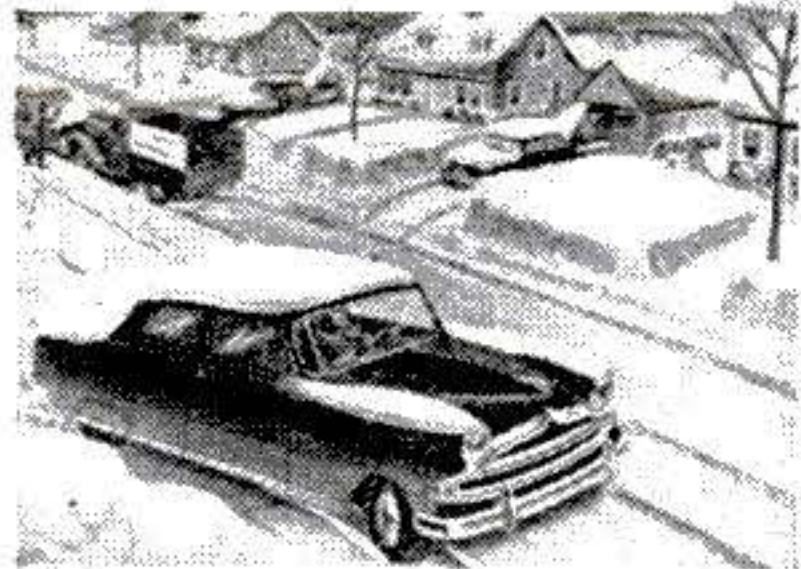

**WHEN YOU
CAN START
LIKE THIS**

**Easier starting in any
kind of weather**

**BUY THE SENSATIONAL NEW
Redi-Warm
AUTOMATIC ENGINE TENDER**

FOURTEEN VITAL POINTS PROTECTED

**Write for Redi-Warm FREE Booklet With
Pictures**

Redi-Warm, a simple thermostatic unit has complete safety controls. It is easily installed on any engine head bolt or manifold stud.

Redi-Warm assures your engine of very close to "heated garage protection" or even better, because you have Redi-Warm protection with you wherever you may drive.

Redi-Warm helps protect you even in blizzards and sub-zero weather.

Now you can buy engine tending "like a baby sitter" or "a mother's care."

Helps keep 14 vital points warm by actually cranking up the engine — and automatically — whenever it needs warming up.

Redi-Warm care is the truly natural care. It uses only the natural, internally, self-generated heat from the very heart of the engine.

No half-way measures! No plug in monkey business!

Avoid possible damage or warpage due to mere fragmentary heat applied only in spots! Reduce sludging!

Still some openings for salesmen, agents and distributors.



A. MAIN UNIT



B. NEUTRAL SWITCH



C. DASH SWITCH

**ORDER
TODAY**

**only
\$24.95
postpaid**

- KEEPS ENGINE ALWAYS AT STARTING TEMPERATURE REGARDLESS OF WEATHER.
- CAR CANNOT BE STARTED WHILE REDI-WARM IS SET FOR OPERATION; THIEF-PROOF — FOOL-PROOF DOUBLES BATTERY LIFE.
- SAVES WEAR ON ENGINE; SAVES GAS ORDINARILY USED IN CHOKING.
- SAVES TIME — SAVES TEMPER — ELIMINATES COSTLY TOWING CHARGES.
- PAYS FOR ITSELF OVER AND OVER.

**Agents
Wanted**

**CRAY-LINCOLN
Eng. & Mfg. Co., Inc.**

Cray Oil Bldg., North Walpole, N.H., U.S.A.

Trouble Is Their Pastime

[Continued from page 98]

its matchstick legs, was a brand-new calf.

More unusual yet, in the realm of aerial animal rescues, was the exploit of a Colorado CAP pilot who spied a horse imprisoned in a canyon by snowdrifts. Every day for two weeks he flew in a load of hay and dropped it close enough for the horse to reach, finally attaining such accuracy, as he liked to tell his buddies, that "that danged horse only has to open his mouth to catch dinner on the fly."

Fight Weather and Winds

Out West is where the CAP's aerial bird dogs get their most arduous workouts. The number of lost planes is high, for distances are great and the weather as undependable as a dictator's promise.

It takes a low-flying, slow-flying aircraft to do the job of searching when CAP wires buzz: "Plane overdue—presumed lost." The fussy little back-yard grasshoppers squirm through narrow canyons on one wingtip, drag wooded hillsides and hedgehop across low mountains and mesas, close enough to the ground to pick up the smallest clues.

Yet the eagle eyes of the Sunday pilots can be a source of irritation. During a CAP search for a lost ship, 20 different airplanes buzzed one ranch. At last, the nettled rancher called the nearest airport and demanded to be let alone. He explained that those shiny bits of equipment laid out on the ground, attracting the attention of every passing searcher, weren't pieces of busted-up airplane. They were the parts of a new windmill he was assembling.

Table-Top Flying Is Hazardous

It is hazardous, this table-top flying—"the most hazardous noncombat flying there is," a CAP pilot described it. And it is over some of America's most formidable terrain, through air so turbulent that it has been known to bounce all the gasoline out of a ship's carburetor and stall the engine.

CAP members get no pay for their aerial trouble shooting. The Government picks up the tab for gas and oil used in search-and-rescue and that's all. The pilot himself pays for wear and tear on his plane.

Arizona's CAP wing is typical of the 52 units functioning in every part of the Union. Arizona has 19 squadrons and a varied membership that includes a 90-year-

[Continued on page 244]

You can do
80% of your
Woodworking
Jobs

WITH THIS

DELTA Saw-Jointer UNIT



A BASIC SHOP IN ITSELF—rips, miters, cross-cuts, angle rips . . . makes double miters, cut offs . . . joints, planes . . . with accessories, it makes dado grooves, shapes, tenons, rabbets, etc.

Here's the greatest time-effort-space saver you ever saw! It performs most of your woodworking operations, without converting. That means each operation can be performed *in sequence*, without changing over your machine between steps.

For example:

1. Set the circular saw to within $\frac{1}{16}$ " of dimension and make your cut.
2. Set the jointer for $\frac{1}{16}$ ", run the piece through—and there you are, with a perfect, true, square edge.

These two basic tools are run by the same motor. You can operate both at the same time, or either one individually. Each tool is of correct working height and there's no interference.

This efficient combination tool is a favorite with experienced home-crafters. It has the dependable, built-in precision quality that has established Delta's fine reputation in Industry and among home-shop enthusiasts.

See this great tool at your Delta dealer. Also send for the valuable free book "How to Start Your Home Workshop"—packed with pictures, good ideas, practical suggestions. Use the coupon.

SEE HOW DELTA ACCESSORIES ENABLE YOU TO DO COUNTLESS EXTRA THINGS

With the Delta Moulding Cutter Head and a set of cutter knives you can cut almost any conceivable moulding shape. You can add more knives as you want them. Other versatile accessories include tenoner and a dado head.



DELTA POWER TOOLS

Another  Product

53 MACHINES • 246 MODELS • MORE THAN 1300 ACCESSORIES

DELTA MILWAUKEE Wood and Metal Working Power Tools FOR HOME AND INDUSTRY

DELTA POWER TOOL DIVISION
Rockwell MANUFACTURING COMPANY
805 A E. VIENNA AVE. • MILWAUKEE 1, WIS.

- Send me free "How to Start Your Home Workshop"
 Send me the name of the nearest Delta dealer

Name _____

Address _____

City _____ Zone _____ State _____

JANUARY 1952 243

For cross-grain planing and light with-the-grain cuts — Millers Falls No. 16 Block Plane



For finishing large surfaces — Millers Falls No. 9 Smooth Plane



For truing edges and general all-round use—Millers Falls No. 14 Jack Plane



Three Great Planes

There's a feel and balance and fast-cutting accuracy in Millers Falls planes that has made them favorites for generations with men who use and prize fine tools. So, when you buy a plane — ask for a Millers Falls. Sizes and types for every purpose — smooth-cutting, long-lived tools you will be proud to own.

Millers Falls Company, Greenfield, Mass.



The Mark of Superiority

Trouble Is Their Pastime

[Continued from page 242]

old desert prospector and a legless veteran.

Biggest of all the Arizona CAP's mercy missions was its part in the great western haylift of 1949. While the Air Force and the Navy went to the rescue of the cattlemen, the CAP's special job was probing far up into lonely, distant canyons to find isolated hogans and drop supplies to the starving Indians. They did their work low over icy wastelands where engine failure would have meant certain death.

Indians Get Choosy

The haylift lasted for many days. CAPers knew the worst was over when the Indians started getting choosy, spelling out "CANDY," "GUM" and "FOLGER'S COFFEE" in the snow.

Nothing gets the goat of a CAPer quite like the accusation that he is buzzing.

"Heck," says Mike Morris, former commander of the Arizona wing, "buzzing is the only way we get the job done."

Some time ago, when a CAP man discovered the wreckage of a missing bomber at the bottom of a deep canyon, an Air Force colonel decided he wanted to have a look at the wreckage himself. So he and the CAP pilot flew to the crash site in a big transport.

Colonel Told Off

Meanwhile, another CAP searcher had spied the debris and gone down for a closer look. He was meandering around the bottom of the canyon in his flivver ship when the colonel's plane arrived high overhead.

"Who's that dumbbell down there?" the colonel demanded. "He'd better get out or we'll be picking up his pieces, too!"

The colonel's companion shot him a look of polite scorn. "Colonel," he said quietly, "how d'ya think we find your lost airplanes—from way up here?"

END

Science Aids the Hot Tamale

For the past several centuries, the housewives of Mexico have ground wet corn to make flour for tortillas, tamales, and other south-of-the-border favorites. But the dough spoiled quickly, and much of it went to waste. Now the Armour Research Foundation, in cooperation with Mexican authorities, has perfected a process for large-scale production of dried tortilla powder.

Get the Extra Production Capacity, Extra Versatility of *Atlas* 10" Lathes

"QUICK-CHANGE" 10" LATHE

- ★ Timken Tapered Roller Bearings!
- ★ Precision Ground Bed!
- ★ Reversible Automatic Power Cross and Longitudinal Feeds!
- ★ 16 Spindle Speeds — 28 to 2072 RPM!
- ★ Quick-Change Selection of 54 Threads and Feeds!
- ★ V-Belt Drive!

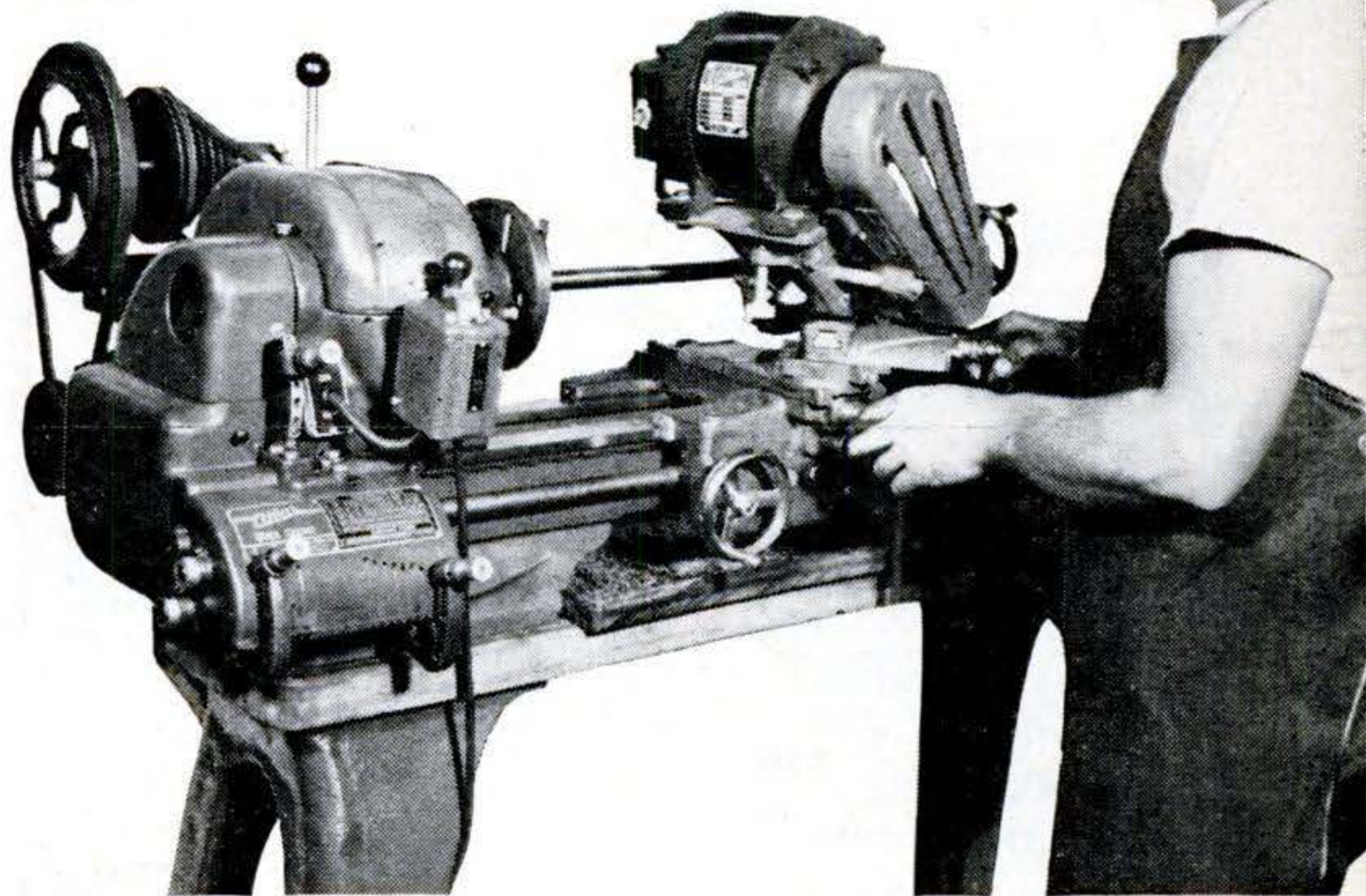

Handle Precision Tooling and Precision Production Runs at Lower Cost

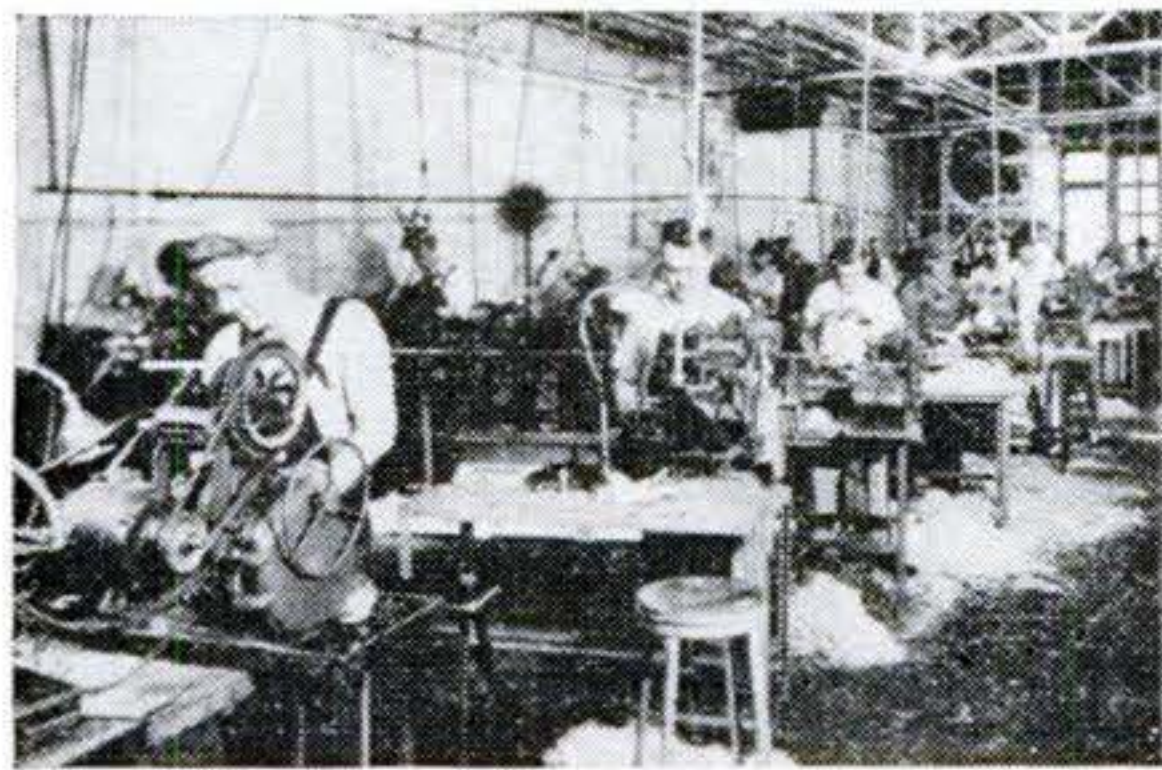

Starting business with one Atlas 10" lathe, this plant has made over 500,000 precision parts.

The many standard construction and performance features you get *without extra cost* make the Atlas 10" lathe the most exceptional value on the market today. For tool room, production, maintenance, service, development work in your plant or home shop — be sure to see how the Atlas can handle your requirements with greater accuracy and efficiency — *at lower cost*. Ask your Atlas dealer or send coupon for latest catalog.

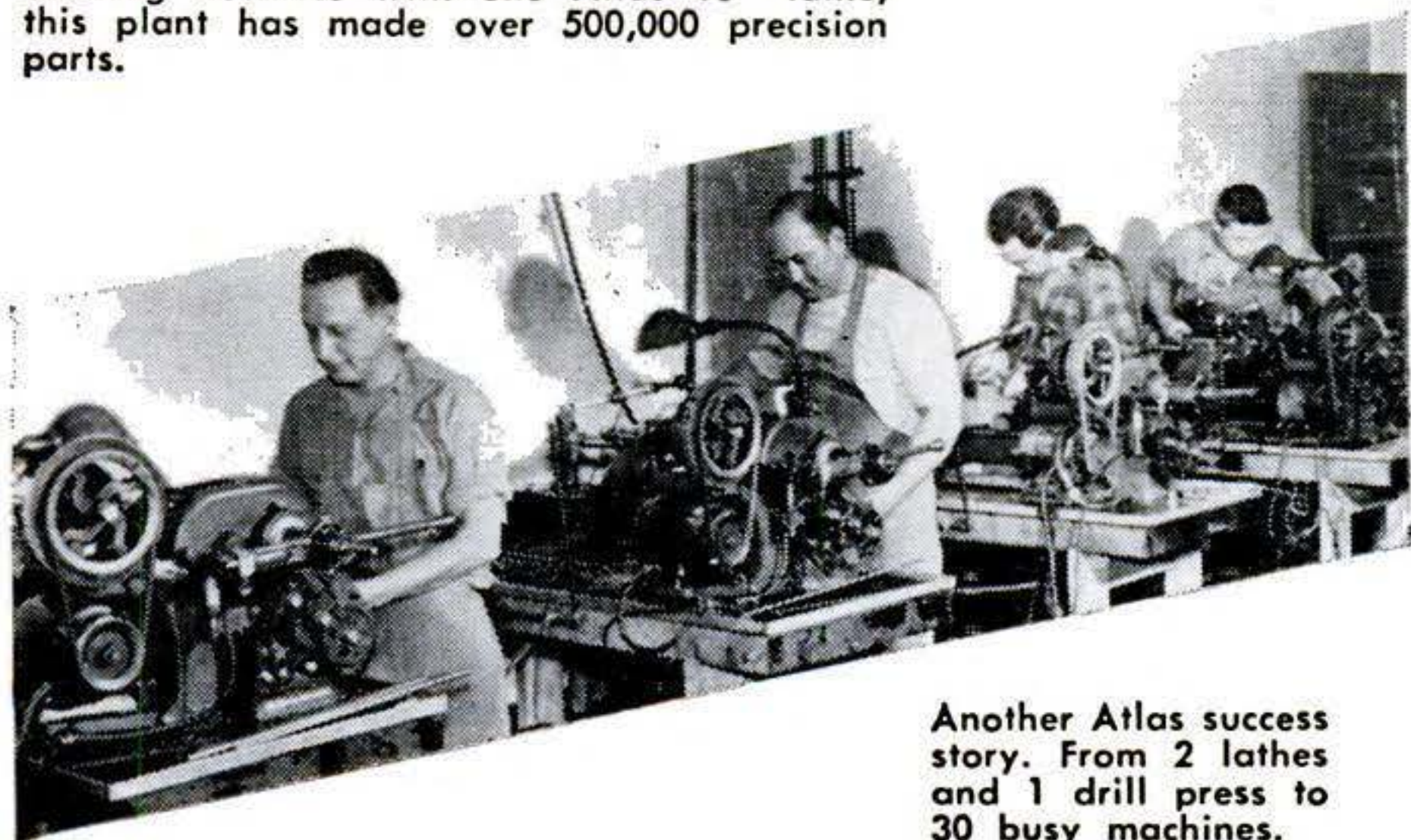

Another Atlas success story. From 2 lathes and 1 drill press to 30 busy machines.

Atlas PRESS COMPANY
155 N. Pitcher St.,
KALAMAZOO, MICH.

Free CATALOG - Send Today!

ATLAS PRESS CO.
155 N. Pitcher St., Kalamazoo, Mich.
Please send your latest 10" Lathe catalog.

Name _____

Address _____

City, State _____

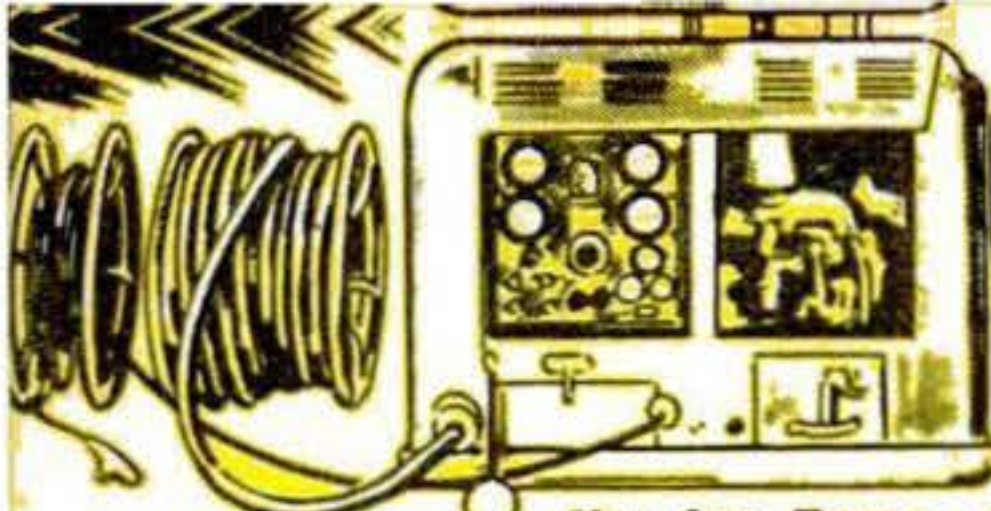

**ON THESE BRAND NEW
WAR SURPLUS POWER UNITS**

**BE PREPARED
for any emergency!**

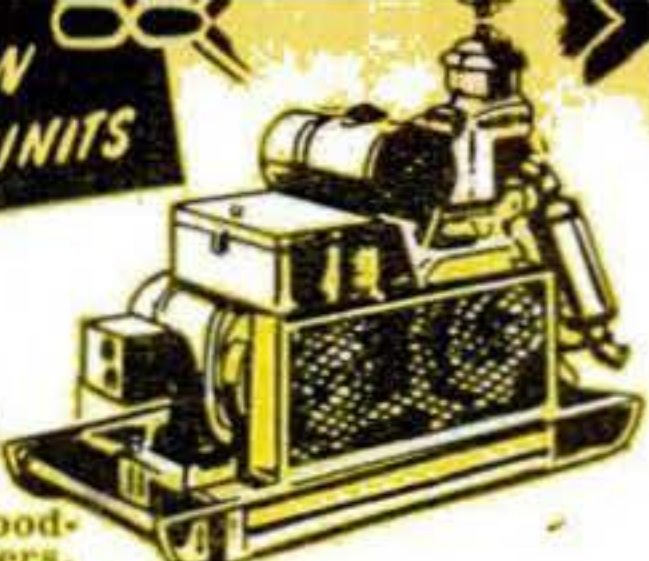

Use for: Farms, cottages, stores, garages, flood-lighting, drilling rigs, refineries, house trailers, fire departments, sound trucks, yachts, tugs, construction, airports, police radios, etc.

LIGHT PLANT BUYERS in emergency telephone collect—unit shipped same day!

300 WATT 110-220 v. AC, 60 cycle light plant powered by 1 HP gas engine, direct drive, mounted base, wgt. 40 lbs. Ideal for campers, P.A. systems, house trailers, etc. Equipped with handle for easy carrying. **\$99.00**

750-1000 WATT, 110 v. AC, 60 cycle, direct drive, air cooled, Briggs & Stratton gas engine, Model AP, Pioneer generator, radio filter, self-exciter, rope start, 190 lbs., 20" long, 17" wide, 16 1/2" deep with carrying handle. New. **\$169.00**

1000-2000 WATT 110 v. AC. **\$194.00**

2000-2500 WATT 110 v. AC, 60 cycle, slow speed generator, 5.10 HP Briggs & Stratton gas engine. NEW **\$294.50**

To make plant 110-220 add \$40 for transformer.

2500-3000 WATT 110 v. AC, 60 cycle, Leland generator, runs at slow speed (1800 rpm) for longer life. 8.25 HP Briggs & Stratton gas engine. You can rely on this plant for all average home needs—freezer, stoker, pump, hot plate, radio, etc., and overloads from starting motors. Reconditioned and fully guaranteed. **\$295.00—NEW. \$345.00.** Plants, same as above, built in 1951, with tools and spare parts. **\$426.00**

Lists at \$790.00. Our price **\$465.00**

To make plant 110-220 add \$48 for transformer.

3000 WATT, 110-220 volt with push button starter. Starter battery automatically charged by plant. Gas engine same as in plant above. **\$465.00**

CONTRACTOR'S PORTABLE DC 3000 WATT Briggs & Stratton 5-7 HP gas engine with Delco generator and rubber tired wheels. Used. **\$220.**

NEW **\$279.**

5000 WATT 120 v., 60 cycle AC, Hercules 4 cyl. gas engine. Generator mfr'd by Hobart Bros. Unit includes remote control cable, 150' 2-wire #6, and 150' 3-wire #18, exhaust pipe, power cable plug, spare parts, manual, battery, radio and TV filtered. Unit is completely automatic. List price today \$1910. **\$895.**

Now priced for you at **\$675 used. NEW.**

To make plant 110-220 add **\$72** for transformer.

7500 WATT 110 v. AC. **\$995.00**

4 cyl. gas engine. NEW

10,000 WATT, 110-220 volt AC, 60 cycle. Remote control. Powered by a Jeep 4 cyl. gas engine. Used but like new **\$1495.00**

\$1195.00. NEW.

25,000 WATT, 220 volt AC, 3 phase or 110-220 volt single phase. Used but like new and **GUARANTEED . . . \$2495.00**

\$1995.00. NEW

35,000 WATT, 110-220 volt. **\$2995.00**

Diesel. Rebuilt

50,000 WATT, Cummins Diesel generator. 240 volt, 3 phase, 60 cycle. AC 1200 RPM. 150 amps. Rating 50% continuous exciter. NEW—**\$5900.00**

GUARANTEED



**HEAVY DUTY RUBBER
ELECTRIC CABLE**
(Nothing less than 50 ft.)

4 Wire = 18 Neoprene standard, per ft. 7c
2 Wire = 14 18 ft. with plug. **\$3.00**
2 Wire = 14 18 ft. NO plug. **\$2.60**
2 Wire = 14 50 to 225 ft., per ft. **17c**
2 Wire = 12 12 ft. with plug. **\$3.50**
3 Wire = 10 50 to 225 ft., per ft. **30c**
4 Wire = 10 75 ft. length, per ft. **40c**
3 Wire = 6 150' with connector. **\$125.**
2 Wire = 6 150' with connector. **\$ 90.**
2 Wire = 4 75' reel and connectors. **\$ 80.**
2 Wire = 4 Concentric 50 to 250 ft. underground, per ft. **60c**
1 Wire = 1.0 Rubber 50-500', per ft. **54c**
15 Cond. = 18 G.E. Stranded 50-300' O.D. 13/16", per ft. **50c**
10 Cond. = 18 Solid, per ft. **10c**
Telephone Wire 250', per ft. **2c;**
1000' **1 1/2c**

SPRAY BOOTH FAN
18 Inch

Handles all spray booth and air exhausting jobs with absolute safety in atmospheres containing dust. Totally enclosed 1 HP Motor, 220/440, 3 phase, 3400 RPM. Sealed lifetime bearing. **\$109.00**

Reconditioned . . .



HOT ROD SUPERCHARGER



Extra soup and go at a price can't afford to miss. SEE THE SIMILAR SUPERCHARGER used in PICTURE and article p. 67 AUG '50 POPULAR MECHANICS. Mfr'd by Borg-Warner. Specifications: 7 1/2" deep, high. Wgt. 17 lbs. Compact sturdy, 4 base mounting hole 3/4" outlet, 3/8" shaft with ferrule Lovejoy coupling. Priced today at **\$85.**

OUR SPECIAL SALE PRICE **.. \$31.00**

BRASS HAND PUMP
Mfr'd by Red Jacket. Pumps 300 gal. in 30 strokes. Ideal for boat bilge, basements, cattle troughs or other water transfer. 1 1/2" inlet, 1 1/2" or 2" discharge. 78 lbs. **\$48. value. Only \$24.**

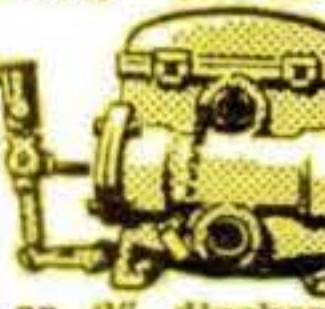

COLD WEATHER

HEAT CONTROL



Made by Minneapolis-Honeywell a name known for the best in controls. 1000 watts—115 to 200 Element length 10 Range 70° to 212° Controls fans, motor furnaces. Makes an ideal automatic combination when hooked up to heat boosters at right List price **\$16.00.** Your price **.. \$6.**

Prevent Frozen Water Pipes
WRAP-AROUND HEATING CABLE
Electric. Prevents frozen water pipes at temperatures as low as 35° below zero.
26 ft. 60 w. **\$4.**
56 ft. 140 w. **5.**
112 ft. 280 w. **7.**
Thermostat for above set at 35° F. **5.**

"JANITROL" AIRCRAFT HEATERS



Warms up fast—just the thing for heating trucks, buses, garages, etc. Has an output of 50,000 BTU'S per hour. 24 v. DC. Length 23", diameter 1 1/2" wgt. 14 lbs. Original cost \$130. Special price **NEW \$19.**

ORDER DIRECT from this ad! All price F.O.B. Milwaukee. 25% deposit required on all C.O.D. orders. No C.O.D.'s under \$10.00. Many other bargain items not listed. Write for our FREE CIRCULARS!

P&C Hot Forged Tools
**Stay on the
job Longer!**

Really tough jobs—in industry or at home—prove that special analysis alloy steel and scientific heat treating make P&C tools last longer. More than 300 P&C tools are easier and faster in everyday use or on special jobs.

Ask your hardware dealer for the P&C tools you need; he will recommend them.

Write for the new folder on P&C tools—"the BEST tools money can buy."



**P&C HAND FORGED
TOOL COMPANY**

BOX 5926-F, PORTLAND 22, OREGON

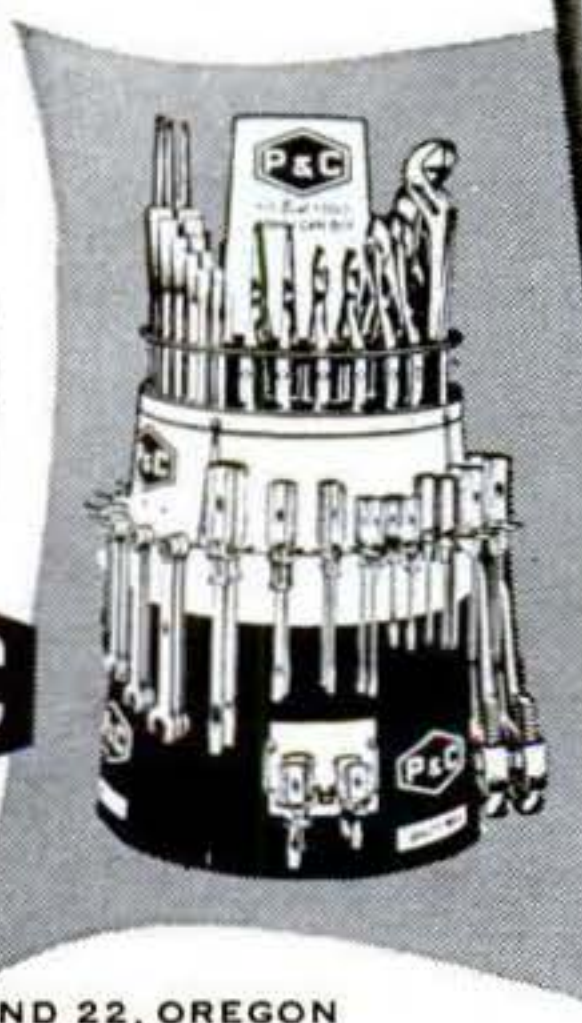
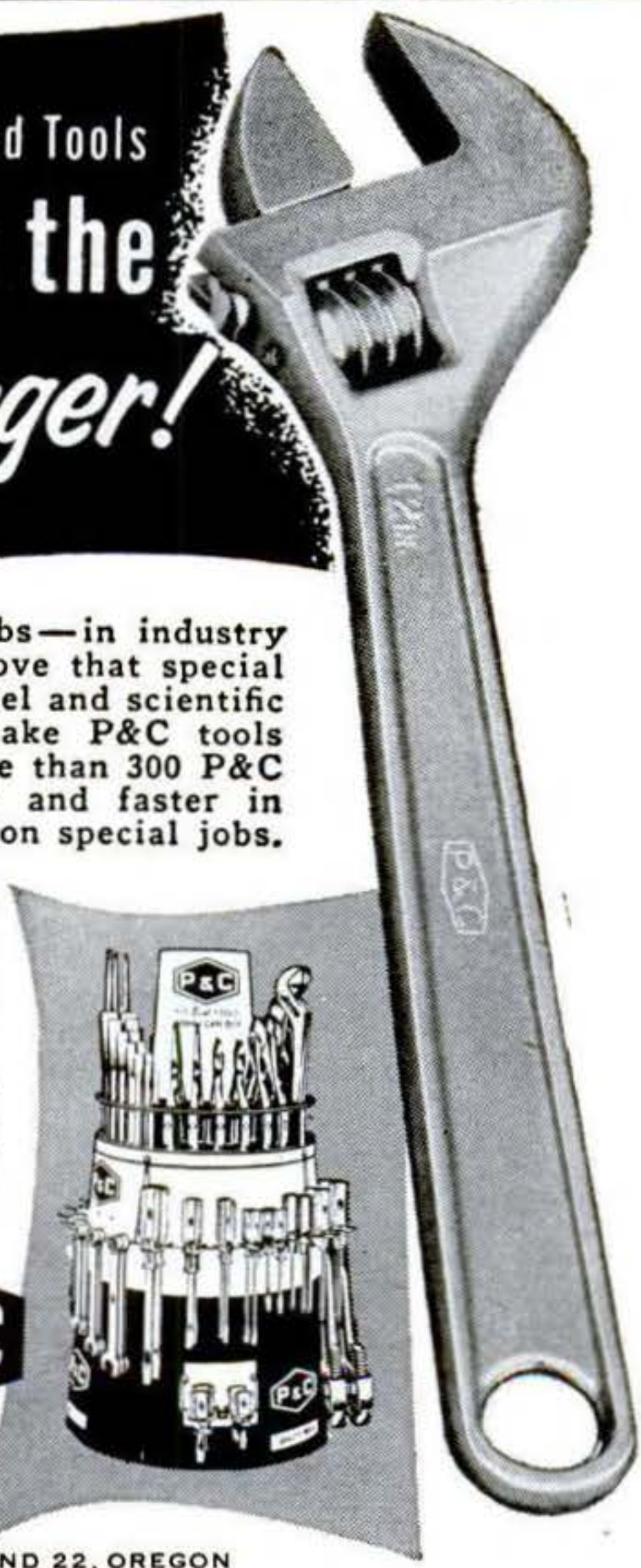

DO IT EASIER - FASTER - BETTER
with a **SHAW** "DU-ALL"
WALKING OR RIDING TRACTOR

1 1/2 to 5 H. P. Walking Models
Do Everything In Gardening

3 H. P. Walking Model with 10-in. Plow

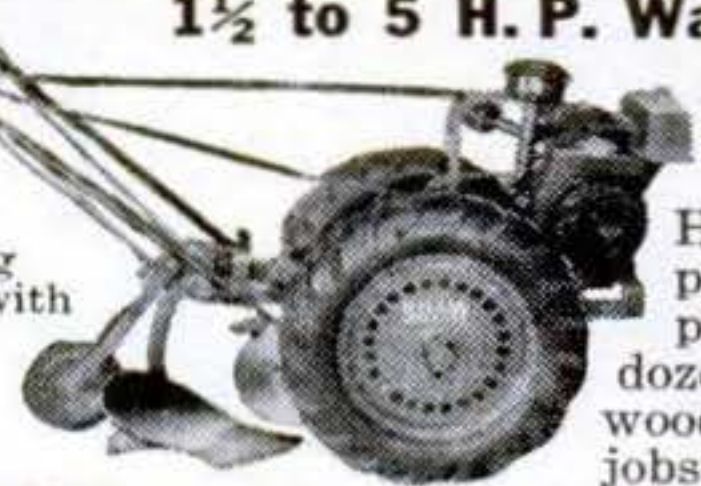

Handle 6, 7, 10-inch plows... cultivate, plant, mow, bulldoze, cut trees, saw wood, do many other jobs fast and easy. 1 1/2,

3 and 5 H. P. machines with variable speed transmission, adjustable wheels, plenty of plant clearance. Power turn models and power take-off attachments available.

Powerful 5 to 12 H. P. Riding Tractors
Handle Work on Good Sized Farm

Also ideal for second tractor on large acreage. 5, 8, 12 H. P. models plow 4 to 8 acres daily, plant, cultivate, mow and rake, do many other jobs. Works astride or between 42-in. rows.

12 H. P. Shaw Du-All with 12-in. Plow

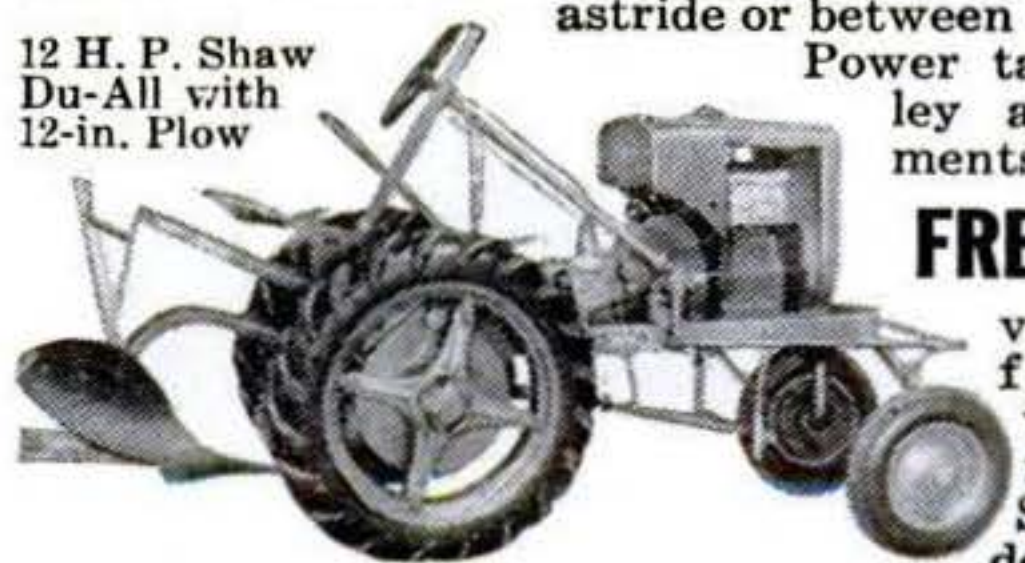

Power take-off pulley and attachments available.

FREE catalogs and best values you'll find anywhere, by return mail. See a Shaw dealer. Write

SHAW MANUFACTURING CO.
5701 Front St., Galesburg, Kansas
668-PS N. 4th St., Columbus, Ohio

You'll save and be sure!

ALL ITEMS GUARANTEED AS REPRESENTED
Order with confidence from C&H

"Mail" Portable GRINDERS
Flexible Shaft
 1/2 HP, 3450 rpm, 110 or 220 v. dustproof motor mounted on universal swinging trunnion. Heavy base has convenient tool tray and large, easy rolling casters. Flexible shaft is equipped with full speed angle and straight spindles. Lists at \$172.00. Your price with all attachments **\$109.00**





TOOL POST GRINDER
 HP AC-DC, 7000 rpm motor with 3 1/2" x 3/8" external grinding wheel, smaller internal wheel, 7 ft. rubber cord, switch and attachments. Lists at \$90.00. Your price **\$49.50**

BALL BEARING ARBORS
 Grinding and saw arbor, has 1/2" double end shaft, 1 1/4" long with 2" center pulley. New Departure double roll ball bearings. Right and left hand thread. Self aligning Dodge pillow block, 10,000 RPM. Bearings alone list at \$10. Complete arbor new **only \$6.95**



ALARM HORNS • SIRENS
 Motor driven (not a vibrator). Heavy duty, adjustable for high, medium or low tone. 110 volt AC current. Weather proof. For alarm or signal horn on boats, school yards, factories, air raid sirens, etc. Lists at \$47.00. **NEW.** Your price **only \$15.45**



Build YOUR OWN Elevator
 DUMB-WAITER
 Get all the convenience of a dumb waiter elevator in store, restaurant, shop or home at lowest cost. We furnish complete parts for elevators similar to those described in ARTICLE on p.p. 174-177 Dec. '51 issue of POPULAR MECHANICS. Steel Car—Guide Rails—Worm Gear—Limit Switches—Electrical Controls—Steel Cable. SEND 25c for completely diagrammed instructions with list of parts, kits and prices.



EATING SPECIALS

BOOSTER FANS
 Fits any 8", 9", 10" furnace pipe, 1500 RPM motor with 6" cord, mounting frame, 7" blade. Motor 110 volt 60 cycle. 1550 RPM. Easy to install. Silent operation. Warm those rooms with long runs. Stock #583. Regular \$11.95. Your price **\$6.95**



GEAR REDUCER
 Double reduction. Operates on any 1/6 to 1/2 HP electric motor, 22 RPM. Can be used as winch, operate turntable, electric garage door opener, television antenna, Barbecue, dummy elevator. Regular \$45.00. Now Only **\$22.00**

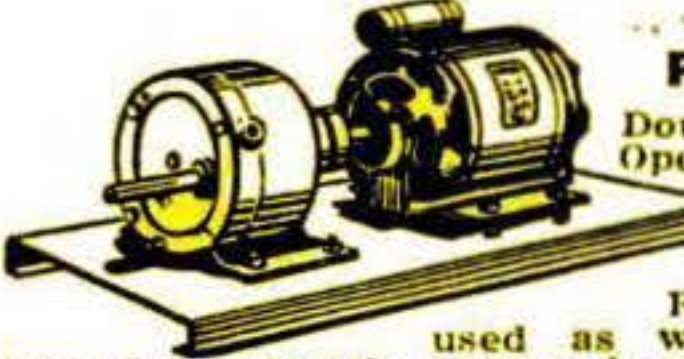

MERCURY CLUTCHES
 For motor scooters, motor bikes, lawn mowers, etc. Centrifugal action enables electric motors or small gas engines to handle heavy starting loads. 3" A belt pulley. **NEW.** 5/8" bore..\$9.95. 3/4" bore..\$10.95. 1" bore..\$11.95.



POWER AND HAND WINCHES
FOR BOATS, TRUCKS, CONTRACTORS, FARMERS, LOGGERS, ETC.

Double drum model WINCHES 1,000 lb. capacity. Hand operated..\$ 9.95
WINCHES Hand operated ball bearing model, 1500 lb. capacity, 3-1 ratio, hand brake, two speeds\$ 39.50
WINCHES 6,000 lb., double drum. Hand operated\$ 49.50
WINCHES 1,500 lb. electric drive.....\$ 89.50
WINCHES 6,000 lb. electric drive.....\$188.50
WINCHES Single drum, 3/4 HP motor 110 or 220 AC. Start, stop and reversing switch, belt, pulleys, 100' 3/16" steel cable, 2000 lb. pull. Ratio 12 to 1. **NEW** \$125.00. Double drum model.....\$135.00
CABLE 1/4" preformed stainless steel aircraft, 100 ft. or less...17c per ft. Over 100 ft....15c per ft.

High Volume BLOWERS
 Top performance for forced draft, ventilating, exhausting, cooling and drying, 110 volts AC, Intake 3", discharge 2 1/2", 75 cubic ft. per min...\$10.95
 Intake 5", discharge 3", 150 cubic ft. per min.....\$13.95



ELECTRIC WATER HEATER
 Westinghouse or Chromalox immersion heating unit, 110 v. AC adjustable from 312-626-250 watts and automatic cut valve. Valued \$42.50. Only \$5.95. Combination price with heat control above.....\$9.95

54 TO 1 BOSTON SPEED REDUCER
 Reduces speed of ordinary 1750 rpm electric motor to 33 rpm. Lists at \$55.00. Our **\$29.50** sale price

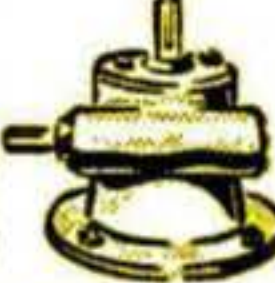

AIR COMPRESSORS
 Gas or electric. Awarded from government.

1/2 HP	12 gal. tank	\$ 99.00
1 HP	50 gal. tank	239.00
1 1/2 HP	50 gal. tank	265.00
2 HP	50 gal. tank	295.00
3 HP	60 gal. tank	410.00
5 HP	60 gal. tank	485.00
7 1/2 HP	80 gal. tank	675.00
10 HP	80 gal. tank	775.00

and other bargain items

GOODRICH RUBBER HOSE 2" I.D. 2 ply, 25' lengths. Value \$25. Only..\$3.95, or 3 lengths for...\$10.00
BINK'S SPRAY GUN HEADS Stainless steel. Take any liquid. Value \$10.00. Only.....\$ 1.75
OHMMETERS Read 25 to 0. In leather carrying case. Regularly \$29.95. Only.....\$7.95
FYR FYTERS Fire extinguisher approved by Underwriter's. Regularly \$14.95. Only.....\$6.95
1/2 TON SHOP Utility WAGONS, steel frame, rubber tires, ball bearings.....\$48.50
WELDING ROD Manufactured by Murex. All purpose type S. AC-DC, 5/32", 50 lb. box.....\$3.00

C&H ELECTRIC MACHINE Co. Inc.
 438A W. Juneau Ave., Milwaukee 3, Wisconsin

INDUSTRIAL BUYERS When you can't find a scarce item — try C & H



For Loose Caster Guides
 Remove the guide, fill the hole with a putty-like mixture of Smooth-On No. 1 Iron Cement and drive the guide back in. It will stay in place, because Smooth-On, in hardening, expands slightly and takes hold tight. Use Smooth-On for tightening other loose parts and also for stopping leaks in boilers, furnaces, piping, radiators, etc. Buy Smooth-On No. 1 in 1 3/4 oz., 7 oz. and 1 lb. or larger sizes at your hardware store. If they haven't it, write us.

FREE Repair Handbook
 Shows how to save time and money, making many household repairs. 40 pages. 170 pictures. Clear directions. Send today.

SMOOTH-ON MFG. CO., Dept. 58A
 570 Communipaw Ave., Jersey City 4, N. J.

Do it with
SMOOTH-ON
 THE IRON REPAIR CEMENT OF MANY USES



Send for this BIG NEW Hunt's WOODWORKERS CATALOG NO. 18

ONLY 15c

NEW LOW PRICES

Offers greatest selection of fine domestic and imported woods--and hundreds of woodworkers items at bargain prices!

You'll save time and money with this big, new catalog. Contains everything wood craftsman needs. Shows 32 rare and fancy woods in color...43 veneer designs...275 scroll patterns...multicolor inlays, overlays, bandings...all kinds of tools, machinery, cabinet hardware, ornaments, mouldings...and pages of valuable tips, ideas, information, instruction. Send for your copy NOW. Only 15c.

- 144 PAGES
- QUICK DELIVERY
- on maple, poplar, oak, mahogany, red cedar, cherry, walnut, and many others—all properly seasoned and kiln dried.

MAIL THIS COUPON--TODAY!

CRAFTSMAN WOOD SERVICE CO.
 2729 S. Mary St., Dept. B-1
 Chicago 8, Illinois

Send me the big, new, money-saving Catalog No. 18. Enclosed is 15c.

Name _____
 Address _____
 City _____ Zone _____ State _____



WITH BOWES COMBUSTION AID

For Fast Starts; Driving Protection

Be *sure* of quick, easy starting this winter! BOWES Combustion Aid absorbs the water in your fuel lines, keeps them free of gums, softens and removes carbon. Easy to use . . . just put it in your gas tank . . . and have dependable, inexpensive cold weather protection! Your Bowes "Seal Fast" dealer can supply you.

START
Faster . . .
DRIVE
Smoother!

It will pay you to visit your nearest Bowes dealer for tire and tube repairs . . . fan belts . . . oil filter cartridges . . . battery cables with terminals that *can't corrode* . . . and other fine automotive services and accessories "for smoother motoring."



**DRIVE IN WHERE YOU
SEE THIS BOWES EMBLEM**

BOWES "SEAL FAST" CORP., INDIANAPOLIS

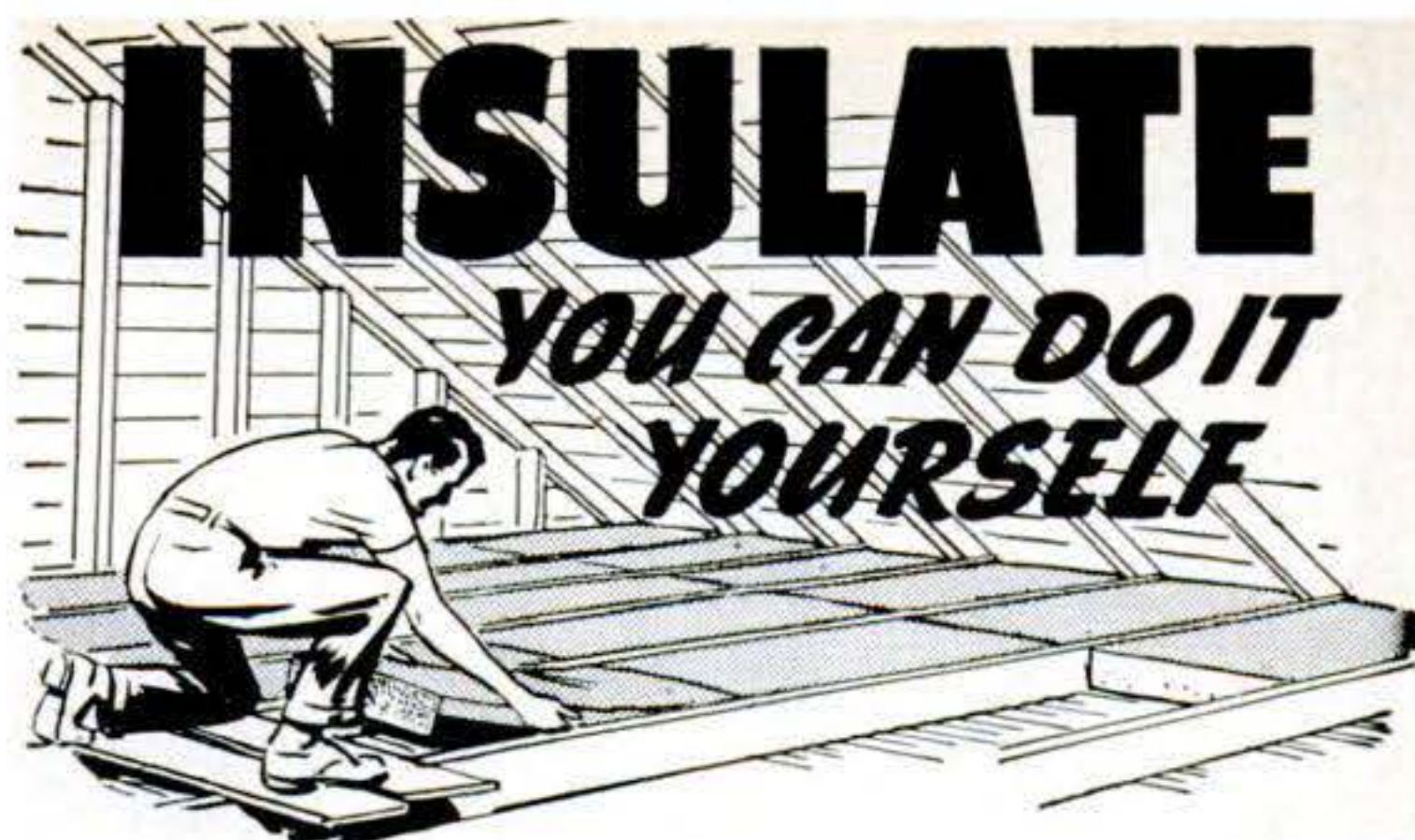

IT'S a cinch to insulate your home with Gold Bond Rock Wool Batts or Blankets. You'll save a lot of money in fuel bills and keep your house warmer in winter, cooler in summer. Light, easy-to-handle batts slide between rafters or attic floor joists. You get extra fire protection too. Gold Bond Rock Wool Batts and Blankets *can't burn*. Batts are 2 and 4 ft. long, Blankets 8 ft. long. Both come in standard widths to exactly fill the space between framing members. Be sure they're "full-thick" and bear the Gold Bond name for maximum insulation and fire protection.

*Available at your local Gold Bond
Lumber and Building Supply Dealer!*

**NATIONAL GYPSUM COMPANY
BUFFALO 2, N. Y.**

DYNA-MITE POCKET RADIO

POWERFUL! PERSONAL! PORTABLE!

- Covers Full Broadcast Band 550-1600 K.C.
- Selective Dyna-Coil Tuning
- Batteries and All Parts Fit Within Case
- Hearing-Aid Battery Powered, Long Life
- Tiny Acorn Low Drain Tubes
- Loud Clear Tone
- Over 1,000 Mile Range
- No Antenna Used for Local Reception
- No Ground Connections Ever Needed
- Picture Diagram for Radio Beginners

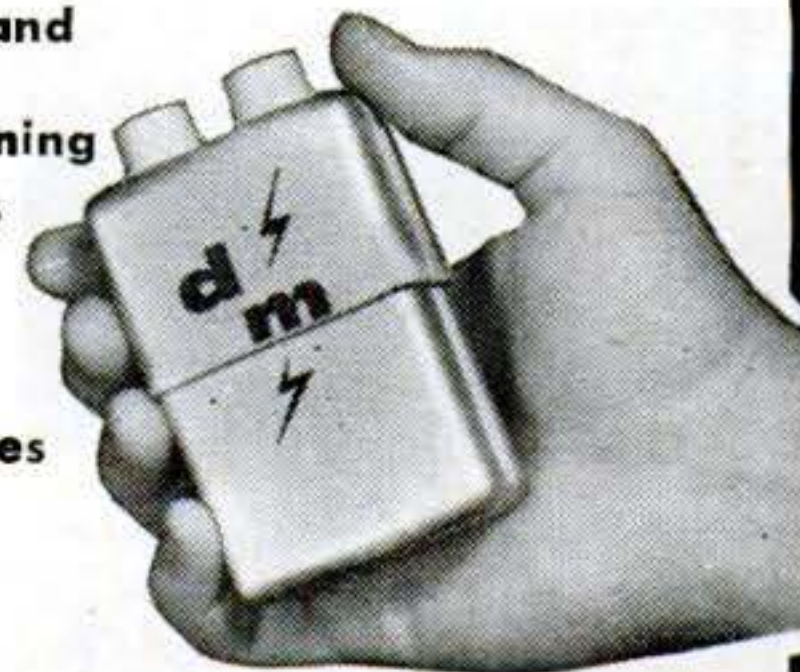

\$5.99
Postpaid

This neatly engineered little set was designed to give you a real personal, portable radio that you can enjoy anywhere without disturbing others. Use it at the ball games, camping trips, in bed, in your office or just anywhere. Remember this is not a weak crystal set but a powerful tube receiver that will give you good local and long distance reception. Complete set, less batteries, **ONLY \$5.99 postpaid**. On C.O.D. orders please remit deposit of \$1.00. If batteries are desired we will supply at only \$1.50 per set or you may obtain from your local hearing-aid concern.

Order Today at this Unbelievable Low Price!

PRECISION ELECTRONICS LABORATORY
BOX 215, RIVERSIDE STATION MIAMI, FLORIDA

AIRBORNE SALES ♦ WAR SURPLUS AND OTHER BARGAINS ♦ SAVE UP TO 90%

WET BATTERY PLATE



Extra long life, re-chargeable, ideal for portable radios, mobile units, etc. 2 V. 20 Amps. Only 5" high ball float hydrometer, built-in Lucite case. Shipped dry. Used singly or in multiples. Shipping wt. 3 1/2 lbs. Govt. cost approx. \$8-NEW-\$1.95.

HAND MITRE



It pays its way in just 1 day! It's sensational! New HAND MITRE saves 100's of hours, requires only a "flick" of the hand for a precision mitre every time. HAND MITRE will cut any desired angle. Its rugged construction handles hard and soft wood mouldings, plastic trim, base shoe, laminated materials, rubber extrusions, etc. Made of heavy gauge stainless steel. \$3.95 postpaid.

"BALTIC" SWEDISH TOOLMAKERS VERNIER CALIPER



ULTRA PRECISION-0-6" in .001 graduations. Quick, accurate depth, inside, outside measurements, fine engraving. Extra heavy rule, hand-fitted sliding head, no side play. Rockwell C.60, lapped measuring surfaces. For the extra particular mechanic who must have the best-used and recommended by most critical experimental and research machinists at Lockheed, Douglas, Bendix, GM, RCA, General Electric. Save 50%! A \$37.50 value—only \$14.75, leather case incl. Also a standard grade Mauer Design Caliper made in Germany. For the production machinist, 0-6" in thousandths, the most accurate caliper of this type on the market, 1000's of satisfied users. Only \$10.95, leather case incl. These Calipers are of acceptable quality for precision aircraft work. Both are guaranteed buys, money back if not entirely satisfied. Order now! New low price due to lower import duty!

MAGNETIC BASE INDICATOR HOLDER

For all types of dial indicators with guaranteed lifetime ALNICO magnets. V-slotted base has a 45 to 50 lbs. pull, permits immediate application without clamps or special attachments and mountings can be made on cylindrical surfaces. For machinists, tool-makers and inspectors. Base 3 1/2" long by 1 1/8" wide. NEW. \$3.50 ea.



LOW VOLTAGE CIRCUIT TESTER

Made for U. S. Ordnance Dept. to rigid specifications. Portable steel hand carrying unit is a self-contained trouble shooting device for making a complete and rapid check of the generator battery circuit, including any circuit and voltage regulators. Battery voltage, regulators, cut-out settings and generator performance can be easily determined. A terrific testing unit for garages, mechanics, truck fleet owners, boat and marine mechanics. Can be used on any 6 or 12 volt system. Govt. cost approx. \$175. NEW—complete with instruction book—only \$32.50. Shipping weight, 20 lbs.



HIGH SPEED DRILLS



All new. Fractional & numbered. Orig. value \$18. Nationally known brand. Assorted sizes. Set of 30, \$3.50

WOODWORKERS DRILLS



From 5/16" to 1/2" with 1/4" shanks. A \$12.50 value—NEW—just \$2.50 for complete set!

HIGH SPEED STRAIGHT SHANK DRILLS

10 different size H.S. Straight Shank Jobber Length Drills, 1/4" to 1/2". (shank same diameter as drill). \$25 value. NEW—\$3.50.



HIGH SPEED DRILLS

SET from 1/4" to 3 3/64", 5 sizes with 1/4" Shanks—NEW—get this, \$3.00 takes this set!

POCKET-PACK PRECISION WRENCHES



Made of first quality chrome-molybdenum steel, heat treated and hardened for extra strength. Each wrench accurately broached to close tolerances. Open end wrench on one end and twelve point box on the other means double usefulness and double value. NEW, complete with plastic case—\$1.75 ea. complete—postpaid in U.S.A.

SOCKET-PACK WRENCH SET



Chrome-plated alloy steel, heat treated, broached to close tolerances. Reversible ratchet handle, with screwdriver bit on reverse side. Built-in spring-loaded ball retainer on both handle and extension. Clear top plastic kit. 10 piece set—NEW—complete \$3.75. POSTPAID in U.S.A.

FLEXIBLE SHAFT MAGNET

For picking up cotter pins, nuts, wrenches, etc., from inaccessible places. Removes Bobbie Pins, etc., from drains. Lifetime Magnetism Guarantee. Highly polished magnet and handle. \$2.00 postpaid

Strong ALNICO V Magnet on 18" flexible, Cadmium Plated shaft.



HEAVY DUTY DROP-FORGED

Blades inlaid Wolfram Vanadium, guaranteed to hold edge under constant severe use on heavy gauge metals of all types. Duckbill blades for cutting straight, circular or irregular forms. Handy spring opening handles for better leverage. Full hand grip. These shears were imported from Germany and only because we made a terrific deal on them can they be priced—NEW—10" size, \$2.45 ea. 12" size, \$2.95 ea.



STEEL SHEARS

RIVET SETS Universal type, case hardened tips. Set of dies will head up any brazier or round head rivet from 1/16" to 1/4". With adapters for air gun or hand use. All new—cost Govt. approx. \$27.00. Complete 15 piece set (wt. 2 lbs.) \$5.00.



DRILL GRINDER

Sharpens round, square or tapered drills up to 6" long. Even an amateur mechanic can get a new, factory finish on a drill in .25 seconds. New protractor feature gives every drill sharpening angle, with 5 convenient angles already marked off. Usable with hand or power stone. A brand new development. All New. \$2.80 ea. Postpaid in U.S.A.



MICROMETERS

Chrome plated, precision engineered, carefully tooled to give long life. All new. 0-1" capacity—\$2.25 ea. 1-2" capacity—\$3.50.



NEW, BIG 1952 CATALOG BARGAINS FOR EVERYONE • SEND 25c FOR YOUR COPY TODAY! ORDER from ad NOW! Send check, money order or cash. 25% deposit required on C.O.D. orders. All prices F.O.B. Culver City, Calif., unless otherwise stated. ♦ AIRBORNE SALES CO., INC Dept. PS152 ♦ SAVE \$\$\$ CULVER CITY, CALIF.

FILE SAWS THE RIGHT WAY

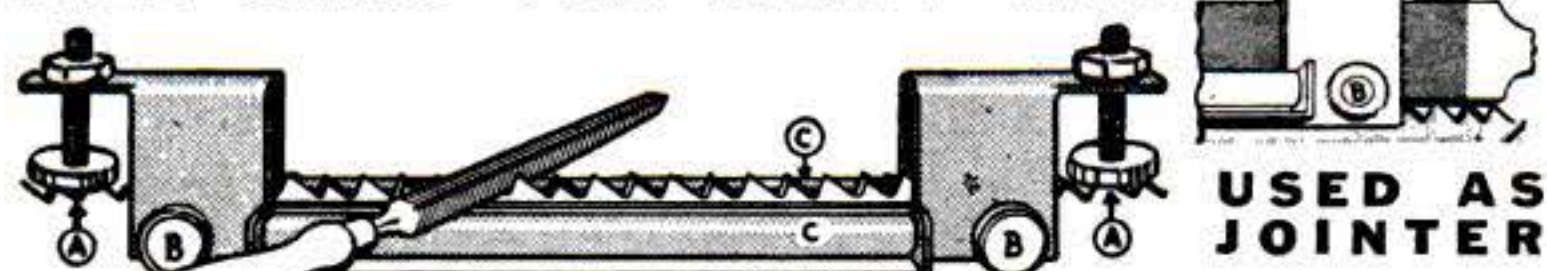

USED AS JOINTER

SO EASY: With this new filing jig and jointer anyone can now sharpen any handsaw like new! When file hits hardened steel rollers teeth are finished and EXACTLY SAME HEIGHT. All teeth cut and saw runs true and smooth. Jig and instructions \$2.95 postpaid. Free literature.

SHARPEN YOUR CIRCULAR SAWS

The RIGHT WAY on your own saw table. Sharpens rip, cutoff, hollow ground and combination blades—6" to 10". Saws stay round with correct bevel. Precision made, easy to use. GUARANTEED. Only \$8.95. Includes \$3.00 Grinding wheel. "TRU-CIRCLE" saw set automatically sets teeth at 10° or more \$2.95



AT DEALERS OR POSTPAID



A. D. McBurney 321 E. 4th St. Los Angeles 14, Calif.

Removing Paint?

You'll be glad you tried WONDER-PASTE—the time-tested paint remover used by professional painters. Just apply it over any paint, enamel, varnish or lacquer and let it penetrate. Then see how easily you can strip off the old finish! No hard scraping or sanding. Won't run on upright surfaces. At leading paint and hardware stores.



Write for leaflet

WONDER-PASTE Over three million cans sold—it must be good!

Wilson-Imperial Company, 121 Chestnut St., Newark 5, N. J.

HOBART Arc Welding PAYS BIG!

If you have this versatile, all around HOBART arc welder, you're equipped to start your own welding business—to cash in on the demand for dependable arc welding.

Costs LESS than you think!
This big 250 amp. gas drive welder is today's biggest value

A FULL CAPACITY WELDER THAT STANDS THE GAFF... OPERATES ON ALL TYPES OF JOBS.

YES, AND YOU CAN TAKE THIS GAS DRIVE WELDER AND WELD ANYWHERE, IT MAKES ITS OWN POWER

Hobart is made in gas and electric drive models—port. or stationary.

Welds anywhere... plus power for lights and tools

You learn RAPIDLY at the HOBART TRADE SCHOOL

Prepare now to step into a big pay defense job or to start your own profitable welding business. Learn to do all kinds of welding quickly, easily, at low cost in America's most modern welding school... the non-profit Hobart Trade School. Complete or partial courses. Best equipment, experienced instructors, thorough training. Check coupon for full details



Start your own welding shop. Earn big, extra profits monthly. All you need is a Hobart "Simplified" Welder and average mechanical ability. You'll soon be swamped with work.

Hobart Welders are used in leading production plants everywhere—give you 1,000 combinations of heat, let you make fine adjustments at the job—no returning to machine.

● **Procedure & Practice.** Complete text and lessons book. Covers every phase of welding. 544 pages, over 600 illus. \$3.00

● **Lessons Book.** Complete operator's training course. 200 pages, illustrated. \$1.00

● Check the coupon for Complete Details

HOBART BROTHERS CO., Box P-12, Troy, Ohio
"One of the world's largest builders of arc welders"

● HOBART BROTHERS CO., Box P-12, Troy, Ohio

Please send complete information and literature on items checked.

Electric Drive Welders Gas Drive Welders
 Hobart Trade School
Send books checked— Lessons Book
 Procedure & Practice Cash encl.
 Send COD

NAME _____

ADDRESS _____

CITY _____

STATE _____

Free
New booklet
"Guide to Better Welding"



BUILD YOUR OWN POWER TOOLS—TILT/ARBOR SAW

Exclusive GIL-BILT Build-It-Yourself Features

- No machining—build easily with hand tools only
- No blueprint reading—step-by-step pictorial plans, full scale patterns, actual photographs
- Sturdy wood, aluminum, and steel construction
- Capacity and performance of commercial saws selling for \$60 and up

**BANDSAW
BELT SANDER
SAVE \$50.
OR MORE**

GIL-BILT 10-INCH TILTING ARBOR SAW

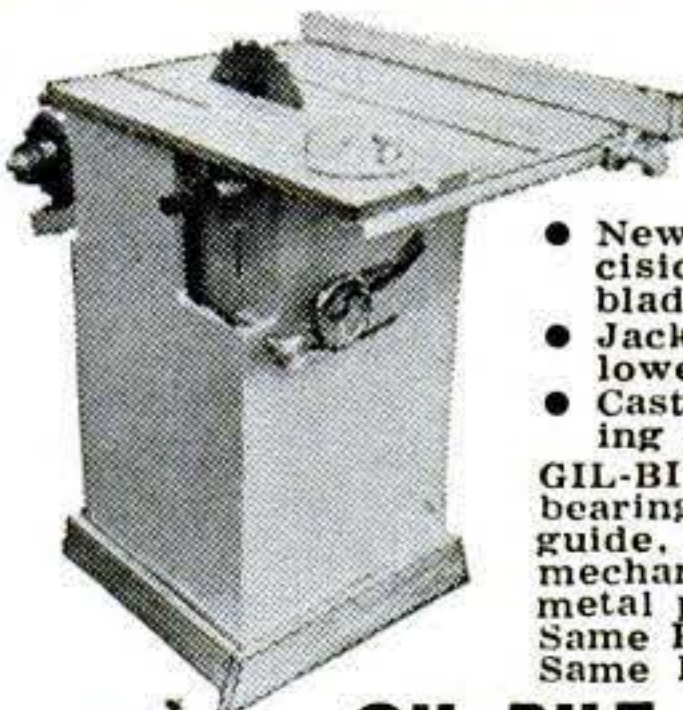

- 27x28 in. table, 13½ in. capacity in front of blade
- 10 in. blade cuts 3¼ in. deep, tilts full 45 degrees
- Floor model 34" high, table always stays level

- New Departure ball bearing arbor, ¾" precision shaft turned down for 5/8" bore blades, alum. housing, shipped ready to run
- Jackscrew and 4½ in. dia. handwheel lowers and raises blade
- Cast aluminum miter gauge and self-aligning rip fence guide

GIL-BILT Metal Parts Kit includes Plans, ball bearing arbor, miter gauge and bar, rip fence guide, dado insert, lock knobs, jack screw mechanism and handwheel, and all other metal parts (less blade).....\$20.95
Same Kit with 10" Combination Blade\$24.90
Same Kit with 8" Combination Blade\$23.90

GIL-BILT 12-INCH BAND SAW



- Cuts to center of 24 inch circle
- Handles stock up to 6 inch thick
- 18x18 inch table tilts 45 degrees
- Lower wheel and drive pulley runs on sealed New Departure Ball Bearings; Upper wheel runs on two 5/8" bore Oilite Bronze bearings

- Upper wheel tension and tilt mechanism of cast aluminum, completely assembled
- Upper and lower blade guides. Each has ball thrust bearing, self-lub bronze jaws
- Rigid cast aluminum wheels fully machined ready-to-install. Heavy rubber tires
- Uses standard 78 inch blades up to 3/8 in. wide
- Fully enclosed mechanism for utmost safety

GIL-BILT Metal Parts Kit includes Plans, rubber tires, aluminum wheels, ¼ in. blade, ball bearing spindle, tilt mechanism, blade guides, table tilt segments, and all other metal parts.....\$20.95

Return Kits in 10 days for refund if not satisfied.
(Prices include postage within 300 miles. Over 300 add 5%)
Also available—Plans and Parts Kit for Belt Sander and 8" Tilt/Table Saw. Order Plans at \$1.00 each—Send postpaid anywhere in the world or write for FREE descriptive catalog.

GILLIOM POWER TOOLS

P. O. Box 1-VA, Lambert Field
St. Louis 21, Missouri

PAGE

2 to 6HP walking and riding models with complete gear drive and reverse. Also new 1-wheel "Bantam." Low prices—easy terms.

PAGE FARM EQUIPMENT
1916 S. 81st, Milwaukee, Wis.

GARDEN TRACTORS

FREE CATALOG



HASTINGS STEEL-VENT PISTON RINGS

The best money you can spend on your car

MODERN LAWN MOWER SHARPENER

FOR LAWN MOWER SHOPS
FIX-IT SHOPS

GOLF COURSES • PARKS

101 OTHER JOBS

Sharpens All Reel Type Mowers • Hand, Power or Gang • 10 to 20 Minutes • No Dismantling • No Extra Attachments Needed.

All reel type mowers, from 5-inch edgers to 36-inch power mowers, are quickly sharpened to extreme ends of both left and right twist blades. Handle, wheels, roller and motor remain in place when sharpening is in process. Bed knife is sharpened in same brackets. Grinding head rides on five ball bearing races. Easy to operate. Also sharpens chisels, joiner knives, planer blades. Big profit maker. Own your own business. Send Today for FREE Illustrated Bulletin No. 11-C1. Prices Subject to Change Without Notice.

ORDER NOW

Immediate Delivery

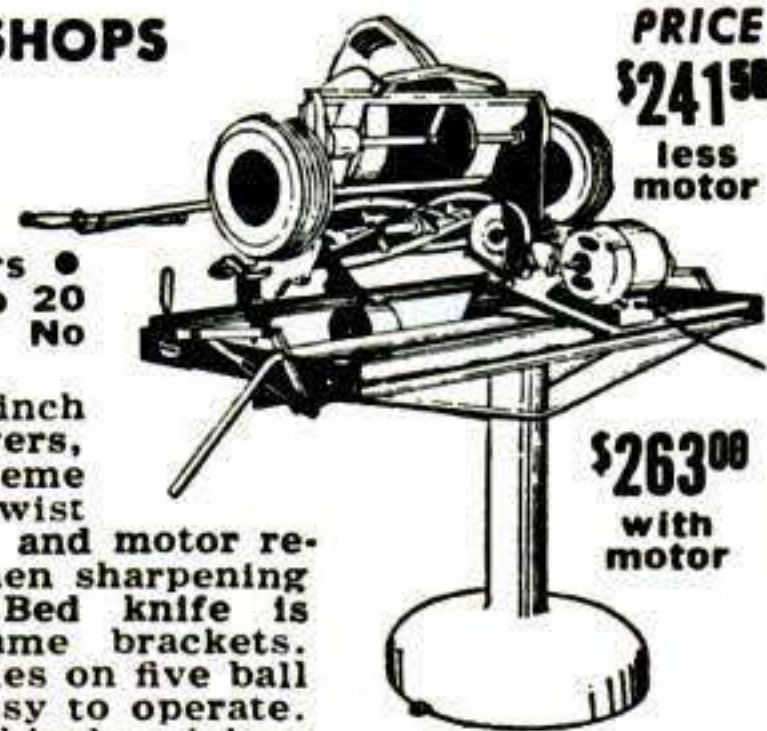

PRICE \$241⁵⁰
less motor

\$263⁰⁰
with motor

MODERN MFG. CO. 160 N. FAIR OAKS AVE
PASADENA, CALIFORNIA

Best Buys
for
Craftsmen!

COMPASS
SAWS

No. 10

No. 37

No. 38

KEY
HOLE
SAWS

No. 6

No. 39

No. 2

BACK
SAW

NEST OF
SAWS

No. 3

No. 36

Here are values no craftsman should overlook — genuine "Silver Steel" quality — accurate, long-lasting, precision-built tools that make it easier to turn out better work. Ask your hardware dealer to let you inspect these top-quality, plus-value products.

Use-
Don't Abuse-
Fine Tools!

ATKINS

E. C. ATKINS AND COMPANY • 402 S. Illinois St., Indianapolis 9, Indiana

Why does your engine wear out faster in winter?

Ask your mechanic—and he'll say it's because it takes time (up to five minutes) for oil to reach engine parts after starting. And in winter, cold oil is sluggish, moves slowly. So friction works longer... causes "Engine Ulcers" as dry metal grinds against dry metal.

But not when you use *Miracle Power* in your gas and oil! The colloidal synthetic graphite in *Miracle Power* clings to surfaces... lubricates until oil gets there. Reduced friction means your engine starts easier, runs with less effort, uses less gas. Try *Miracle Power* next time you get gas.

Miracle Power Division
THE AP PARTS CORPORATION
851 AP BUILDING, TOLEDO 1, OHIO

At better service stations, garages and car dealers, or use this coupon for your introductory offer.



THE AP PARTS CORPORATION
851 AP BUILDING, TOLEDO 1, OHIO

Enclosed find \$_____ for which please send me *postpaid*:

_____ trial cans of *Miracle Power* at 75c each (1 for gas, 1 for oil)

Please send me free literature on making my car last longer.

Name _____

Address _____

City _____ Zone _____ State _____

JANUARY 1952 251

Rustproof Metal!

"KRYLON-ize"

home and garden tools—fishing rods and other sports equipment—nailheads and screwheads—children's playground equipment—lawn furniture—screens—hundreds of other objects!



If you prize it—
"KRYLON-ize" it!

Krylon is a miracle of modern chemistry—a crystal-clear ACRYLIC coating that seals out water, air, moisture, dirt. Just press the button on the aerosol can and spray Krylon on. That's all there is to it! Krylon won't change color, crack or dry out. Waterproof, non-flammable. There's absolutely nothing like Krylon. It's America's Acrylic spray. Spray Krylon on almost any paper, leather, wood or metal surface. Protects, preserves, beautifies. "KRYLON-IZE" leather bags and luggage, valuable papers, photographs, washable walls, etc., etc. Hundreds of uses in every home! At hardware and paint counters everywhere in the big 12 oz. aerosol spray can.

KRYLON is also available in ALUMINUM and BRIGHT WHITE. All the qualities of clear Krylon, plus brilliant color. Go farther, last longer, clean easier, easier to apply than paint or enamel. Big 12 oz. aerosol spray cans.

KRYLON, INC.
2601 N. Broad St.
Philadelphia 32, Pa.

Say "KRYLON" at Your
Hardware Counter



"YANKEE" VISES

*hold work through every step
without a misstep*

Any job locked in a "Yankee" Vise, is correctly positioned for every operation . . . hand or machine. Lifts on and off swivel base at bench. Machined accurately . . . top, bottom, sides and front end . . . V-grooved block for rounds. Four sizes, with and without swivel base . . . 1½", 2", 2¾" and 4" jaw widths. At your dealer's.



Write for
"Yankee"
Tool Book

North Bros. Mfg. Co., Dept. 5
215 West Lehigh Ave.
Philadelphia 33, Pa.

STANLEY

THE TOOL BOX OF THE WORLD

Scientist Invents Color-TV Tube

[Continued from page 147]

—Chromatic Laboratories, Inc., a subsidiary of Paramount Pictures Corp. Since last October, Chromatic has maintained a laboratory in Oakland. As "consultant," Dr. Lawrence makes suggestions and keeps an eye on things. But nuclear physics remains his main interest and he shows up only at odd hours. In fact, he is a bit distressed by the fuss his tube has stirred up. Friends say he does *not* want to be known as "the television man who also invented the cyclotron."

Chromatic is ready to begin producing the tube at a plant in Connecticut. Although details may change under production conditions, the grid will probably contain about 400 parallel wires. The screen will be silk-screen-printed with parallel lines of phosphors a few hundredths of an inch wide. A backing of vaporized aluminum will act as a mirror to increase brightness, and will be charged to attract the electrons. Instead of coming from the gun at the usual 12,000 volts, electrons in the Lawrence tube will start at 4,000 volts and the additional voltage will be added at the viewing end.

END

Bonuses Spur Uranium Output

DURING 1951 the United States advanced to second place among the world's free nations in production of uranium, and now ranks next to the Belgian Congo, the Atomic Energy Commission reveals.

Ranging up to \$35,000, new Atomic Energy Commission bonuses are helping to spur domestic production of the vital raw material for A-bombs and atomic power. These are in addition to a previous \$10,000 bonus offer, which still stands.

The AEC has offered the \$10,000 reward since April, 1948, for "the discovery of a new deposit and the production therefrom of the first 20 short tons of uranium ore or mechanical concentrate assaying 20% or more uranium oxide." This is very high-grade uranium ore—and no one has yet collected the bonus, at this writing.

The new bonuses are within easier reach, and more generous, too. They went into effect last spring and are described in the Atomic Energy Commission's official statement on the subject as "additional incentives for uranium mining."

*To the
4 out of 5 men
who help with
the dishes**



You'll do the job faster, easier and *better* with Dishmaster the push-button dishwasher.

Dishmaster's aerated suds dissolve the toughest grease almost on contact. Dishes, glasses, silver—even pots and pans—come clean in a jiffy.

And because you don't do the dishes *all* the time, you'll want your wife to have the benefit of fast, easy, push-button dishwashing too!



Actor Arthur Lake of "Blondie & Dagwood" fame uses one all the time!



Columnist Cedric Adams says—"I have a Dishmaster—wouldn't be without it."

Handsome, chrome-plated Dishmaster fits any sink. Easy to install.



*A recent survey says you do.

DISHMASTER The Push-Button Dishwasher



HERE'S THE HEART OF YOUR DISHMASTER
Carburetor-like action gives foaming, aerated suds.



FREE

Send coupon for copy of "Dishwashing The Easy Way." If you want a Dishmaster *right away* and your dealer cannot supply you, send Gerity-Michigan your check for \$49.50.

GERITY-MICHIGAN CORPORATION
Dept. A-14 Merchandising Division
10 South Superior Street, Toledo 4, Ohio

Name.....

Address.....

City..... State.....

EXPAND YOUR HOME!

**USE
YOUR
ATTIC**



Install the
**PRECISION
Folding Stairway**
at a cost of
\$60 to \$75

Equipped with Roller Bearings

Makes your home more livable by providing extra rooms and storage space in the most economical way. Fits all ceilings—Just saw a 26x54 inch hole in your ceiling, frame the hole with 2x6's, nail the stairway in place and cut off at the calibrated ceiling height.

SIMPLE AND EASY TO OPERATE—A slight pull of the cord and the counter weights that operate on factory packed roller bearings silently ease the stairway into down position. The same counter weights return the stairway to its up position with equal ease. **RUGGED AND STRONG**—Construction of No. 1 kiln dried poplar. Brackets, rocker arms and hinges of heavy cast aluminum alloy. All parts numbered and interchangeable. Panel insulated and protected with tough chip board. Steps covered with safety treads. **FITS ANY CEILING**—from 7 feet to 10 feet 3 inches high. Runners graduated to facilitate cutting off for different ceiling heights. **REQUIRES NO ATTIC SPACE**—Full height above attic floor only 36". Folds completely into opening in ceiling. **SHIPPED IN ONE PACKAGE**—Each stairway thoroughly inspected, assembled and ready to install. Shipping weight 130 pounds. Sold by more than 12,000 dealers in U.S.A. and Canada. **APPROVED BY F.H.A. EVERYWHERE.** Mail coupon **TODAY** for descriptive folder and complete information concerning delivery, prices and installation.

TO MAKE YOUR HOME MORE LIVABLE,
Mail This Coupon today!



PRECISION PARTS CORPORATION
402 North First Street, Nashville 7, Tenn. PS

Please send me **FREE** folder and complete information on **PRECISION** folding stairways.

Name _____

Address _____

POWER MOWERS & KITS **FREE PLANS**

LOW FACTORY
PRICES DIRECT
TO YOU

3 & 4
Wheel
Model



4
Wheel
Direct
Drive



Build your own quality mower with our **LOW COST KITS, Parts, Engines.** Free Plans guide you, 3 and 4 Wheel Kits, complete. Parts precision finished, ready to use. Write **TODAY** for Free Plans. Low Prices. Parts List and Guarantee.

3-WHEEL KIT NO. T-800

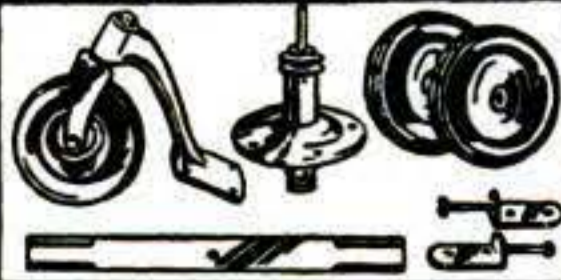

America's Finest Power Mowers completely assembled in 3 and 4 wheel models. Belt or direct drive. 18" and 20" sizes. Nationally known make engine. Latest improved features, sturdy construction and money back guarantee fully described in color folder. Write Today.

TRIANGLE MANUFACTURING CO., Box S-9, Fort Scott, Kansas

254 POPULAR SCIENCE

5,000 MORE MILES From FRONT TIRES

"Educated Nut" Stops
"Scuffing"—**FREE TRIAL!**

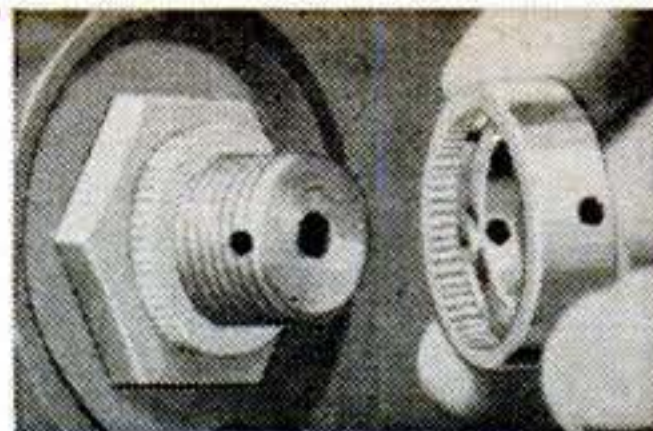

Long used by truck fleets (200,000 now in use) the "Educated Nut" is now available for all passenger cars. Allows you perfect adjustment on front wheel bearings every time. Replaces front wheel bearing nuts now on your car. When you "back-off" your present front wheel bearing nuts to insert cotter pin, you loosen your bearing adjustment enough to cause as much as 3/8" wobble on the tread. This causes "scuffing" and "snaketracking", costs you speed, rubber, gas, brakelining and \$\$\$\$\$.

THE EDUCATED NUT

- Adds up to 5,000 miles more tire life
- Stops bearing breakage
- Makes steering easier, safer
- Increases brake efficiency, stops 90% of all brake squeaks

HOW TO INSTALL

Screw threaded piece up to perfect adjustment (turn up tight, then back till wheel revolves free). Then line up cotter pin holes in cap with hole in spindle. Snap on steel cap, insert cotter pin. You never "back-off" more and destroy adjustment to insert cotter pin as with old style nuts.

FREE TRIAL—Send no money. Just send name and address, make and year of car. A complete set of "Educated Nuts" (2 nuts, 2 caps, 2 pins) and instructions will be sent postpaid. Install and try. Feel the difference in driving immediately! Within two weeks, either return the complete set at no obligation or send just..... **\$2.98**

POLIZZI PRECISION PRODUCTS COMPANY

5024 Lankershim Blvd., No. Hollywood, Calif.

Dept. 1-S

**FREE
Book
on
Painting**

Get this illustrated 24-page book absolutely free. Full of facts on how to get better results with aluminum paint—which type to use for different jobs. Absolutely no obligation—just write:



ALUMINUM COMPANY OF AMERICA
1717-A GULF BLDG., PITTSBURGH 19, PA.

EARN MONEY WITH AN IDEAL SHARPENER

Sharpen lawnmowers, start a business of your own, earn big money. Send for free catalog.
THE FATE-ROOT-HEATH CO.
DEPT. P-4 • PLYMOUTH, OHIO

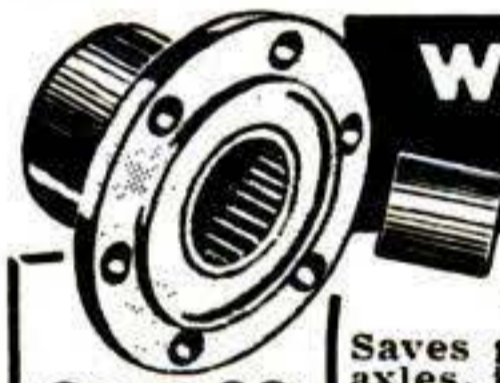

WARN HUB CAP MAKES 2 JEEPS OUT OF 1

Ends front wheel drag on 4-wheel drive Willys Station Wagons, Pick-ups and Jeeps. Saves gas up to 5 miles per gallon, tire wear, front axles, increases speed and power. Stops shimmy—front wheels coast out of gear! 4-wheel drive handles, performs, climbs like 2-wheel. Install or remove **WARN HUB CAPS** in 10 minutes. Polished aluminum, guaranteed. Rush check, M.O., or C.O.D. Write for circular.
WARN MFG. CO., - Dept. S, 1625 3rd Ave., Seattle 1, Wash.

Portable GARAGE

Adds Years
to Car Life

**FREE
10 DAY TRIAL!**

Travels with your car. Folds to small package. Save time, work, money on car washing and polishing. Protect your car from rain, snow, sleet, sun, salt, air, dirt, tree drippings. Built to last of long-wearing, tough first quality heavy gauge clear miracle plastic. Can't mildew, crack or peel. Perma-grip bottom gives complete insulation. Perfect for storing furniture, farm equipment, machinery or what-have-you. Fits all cars. Direct from the world's motor capital means best made for least money.



\$895
heavy duty
\$1095
extra heavy
duty

SEND NO MONEY
YOUNG PRODUCTS
Dept. 114
2605 ELMHURST
DETROIT 6, MICH.

Special Offer
Send name . . . address. Pay postman plus postage or send cash, check or money order, we pay postage. Keep 10 days. Return for refund of full purchase price if not delighted.

EASY TIME PAY PLAN

What?
POWER TOOLS
only \$16 EACH!

GRINDER
SANDER
30" LATHE
HORIZONTAL DRILL PRESS
8" TILTING TABLE SAW

5 POWER TOOLS IN ONE

FACTORY TO YOU \$79.95

SUPERSHOP offers you a precision-built complete power tool workshop. 100% ball bearing. RUGGED. Accurate. Big capacity. 15 day FREE trial. Money back guarantee. Mail postcard for FREE catalog. Buy on easy pay plan.

POWER TOOLS, INC.

231 Yates Ave.
Beloit, Wisc.

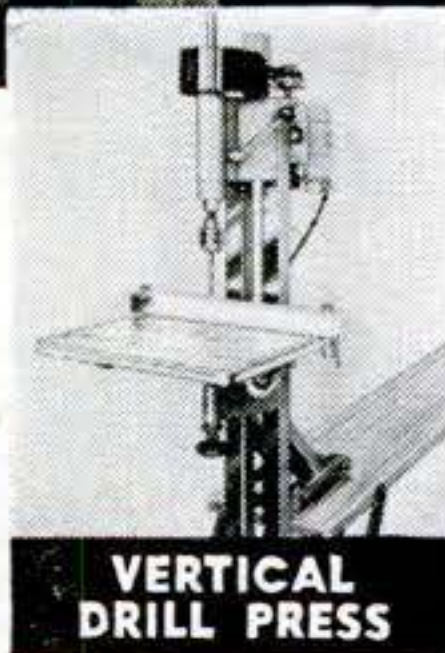

MICRO CUT SAFETY SAW \$3.90 6" SIZE

BUY DIRECT—PROMPT DELIVERY
HIGHEST QUALITY GUARANTEED
FAST CUTTING—SAFE—NO KICKBACK—
Try This Saw—You'll Be Amazed

OTHER SIZES 7"-4.80—8"-5.70—10"-7.20
Sent Postpaid on Receipt of Check or Money Order. Sizes Available for Electric Hand Saws.

Charleston Saw Works, Inc.
1039 BIGLEY—CHARLESTON, W. VA.

AC SPARK PLUGS

THE ONLY SPARK PLUG WITH PATENTED CORALOX INSULATOR

BURN WATER in your CAR

with the **AMAZING OCTA-GANE "50"**

Learn how you can enjoy all the benefits of water-alcohol injection with this all bronze, "fog type", exhaust pressure operated injection unit **WITHOUT SPENDING ONE CENT. . . . NOW OR EVER.** Our sensational new "cost-free" plan, which requires no selling, helps you get automotive accessories, economy products and "hot rod" equipment absolutely Free. Write today for full details and catalog of products offered.

FREE!

WRITE FOR: **FREE ILLUSTRATED LITERATURE**

NARCO, Dept. 06-1, 350 W. Washington Blvd., Venice, Calif.

Starrett

FRICITION THIMBLE* MICROMETERS

Give You

- UNIFORM PRESSURE
- UNIFORM READINGS

Every Time

Starrett
Satin Chrome Micrometer
No. 231-F
Range 0-1" by .0001",
shown above.
Friction Thimbles also available in other sizes and styles.

*An improved ratchet stop mechanism built right into the thimble permits easy, one-hand operation — insures uniform contact pressure for every measurement. You get the same sure accuracy every time . . . plus 12 other big Starrett features including Satin Chrome Finish, Tapered Frame, Hardened Threads ground from the solid and stabilized and Hi-Micro Mirror-Lapped Finish on contact faces. See it at your Starrett Tool Distributor's.

SEND FOR IT — ONLY 10¢
Starrett "Tools and Rules" Book shows the right tools for any measuring job. 50 pages, 100 pictures, helpful reference tables. Address Dept. PS

THE L. S. STARRETT COMPANY • ATHOL, MASS., U.S.A.

TRADE MARK

Starrett

REG U S PAT OFF

SINCE 1880
WORLD'S GREATEST TOOLMAKERS

BUY THROUGH YOUR DISTRIBUTOR MECHANICS' HAND MEASURING TOOLS AND PRECISION INSTRUMENTS • DIAL INDICATORS • STEEL TAPES • PRECISION GROUND FLAT STOCK • HACKSAWS, BAND SAWS and BAND KNIVES

send for **FREE CATALOG**



America's Foremost
money-making
MECHANICS'
TOOLS

It's easy to own the same "pay-off" tools used and endorsed by America's top-earning mechanics throughout the automotive, aviation and industrial fields! Snap-on tools help you handle every repair job faster, easier, better. And they LAST... pay for themselves over and over again! Start building your own tool set now with basic Snap-on units—add others any time. Genuine Snap-on tools are never sold in stores—direct to users only. Mail coupon for free catalog.



SNAP-ON TOOLS CORPORATION
8060-A 28th Ave., Kenosha, Wisconsin
Send me free catalog of Snap-on tools.

Name _____
Address _____
City _____ Zone _____ State _____



FOR HOMES, SHOPS, FACTORIES, GARAGES HOTELS, STORES, OFFICES, FARMS

32 LARGE DRAWERS
96 HANDY COMPARTMENTS

STURDY CONSTRUCTION

JIFFY STEEL FRAME CABINET

You'll find hundreds of uses for this handy all-metal Jiffy Cabinet! 32 aluminum drawers in one 15 1/4" x 12 1/2" x 6" unit. Each drawer is 5 3/4" long, 2 3/4" wide, 1 1/4" deep—perfect for storing nails, buttons, stamps, and other small articles you need and use. Each drawer is divided into three separate compartments, by removable metal dividers... actually 96 compartments to the cabinet! Drawer labels included. Sturdy steel frame, finished in silver-gray color. 8-drawer size, only \$4.95 (24-drawer size \$9.95; 64-drawer size, \$24.95). We pay all postage. Send cash, check or money order. 7-day money back guarantee. **Order NOW.**

ONLY \$12.95
post-paid

TIMESAVERS, Dept. PS-1

2 West 45th St. New York 19, N. Y.

GOOD WOODWORKING



IS A CINCH WHEN YOU HAVE

THESE PLANS

Save money by making your own furniture in your spare time. Rogers simplified project sheets will show you how step-by-step. Send only 15c for which we will send you a full-size jar of Rogers famous Gorilla Grip Glue and include these valuable plans free. Write to Rogers Isinglass & Glue Co., Gloucester, Mass. Ask for Rogers Glue at your local hardware store.

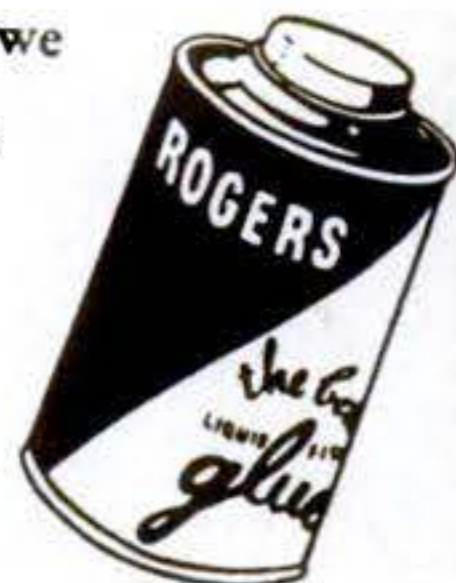

ROGERS
the best LIQUID FISH GLUE
GLOUCESTER, MASS.



"A Ton of Strength in Every Drop"

DO MORE PLANING JOBS WITH LOW-COST BELSAW \$215.00

AMAZING 12 1/4-IN. PLANER Does All Ordinary Planing Mill Jobs. Provides attachments for Jointing, Rabbeting, Tongue, Groove, Matching. 12 1/4 x 6-in. capacity, 3-knife solid round all-steel cutterhead. Power feeds at 24 feet per minute, 42 cuts per inch. Provides for full line of accessory attachments—Grind and Joint knives IN THE CUTTERHEAD WITHOUT REMOVING.

BELSAW MACHINERY CO.
1021 Field Bldg., 315 Westport Rd., Kansas City 2, Mo.



FREE BOOK

BRONZE FOUNDRY

Schools and Home Workshops
Make your own castings of aluminum, copper, bronze, silver. Foundry sets are available in three sizes including 2400 Deg. F. blast Furnaces, \$22.50; \$29.50; and \$42.00. f.o.b. Kansas City. Free Circular.

KANSAS CITY SPECIALTIES CO. P. O. BOX 6022, DEPT. S-1 KANSAS CITY, MO.

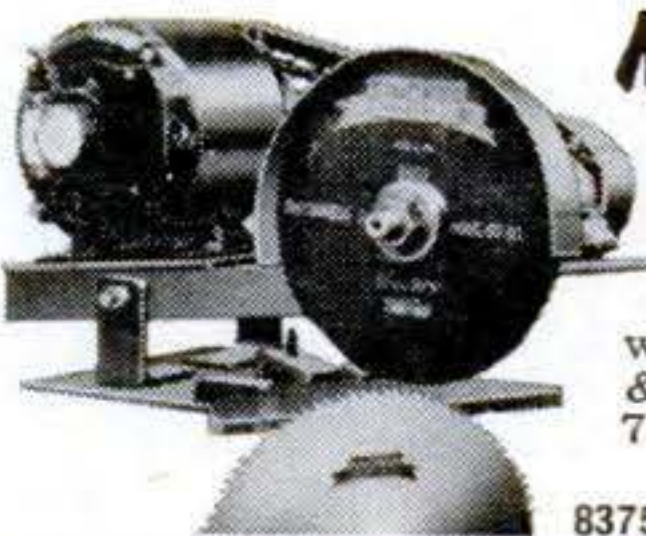

NEW Saw Sharpener

Improved #64 Hand Gummer sharpens all types circular saws 4" to 20" diam. Ideal for saw shops. Self-Centering adjustment for quick, easy set-ups. Complete with 1/4 HP motor, 1 grinding wheel & cord. **\$79.50** FOB Portland, Wt. 70#. **SEND FOR FREE LITERATURE.**

P. T. HOBBS MACHINERY
8375 N. Interstate Ave., PS-12, Portland 17, Oregon

ask your dealer for

Red Devil FP-33

Keeps Floors Gleaming



Tackles any job—scrubbing, waxing, polishing, buffing, sanding... any surface. Twin 6" brushes—no bucking, no sideslip. Write for free folder Dept. PS.

\$64.50

RED DEVIL TOOLS, IRVINGTON 11, N. J., U. S. A.

A SHOPMASTER Circle Saw ...for any Purpose or Price

A Shopmaster Circle Saw is known for its ruggedness and precision.
7" Tilting Arbor Saw \$47.95

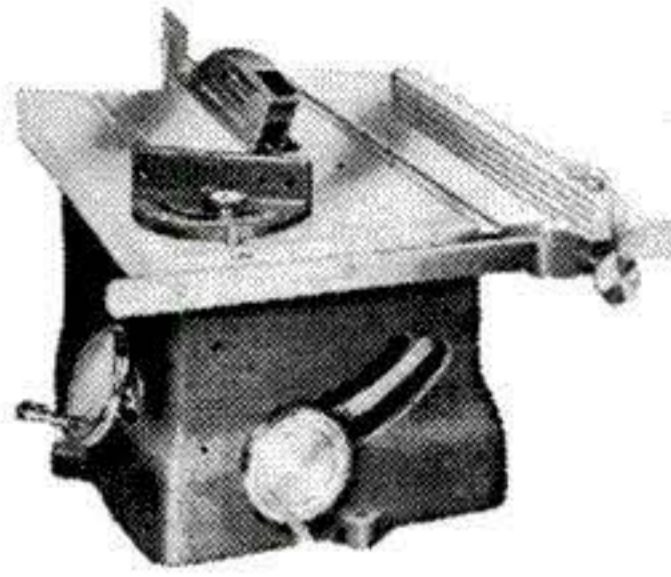
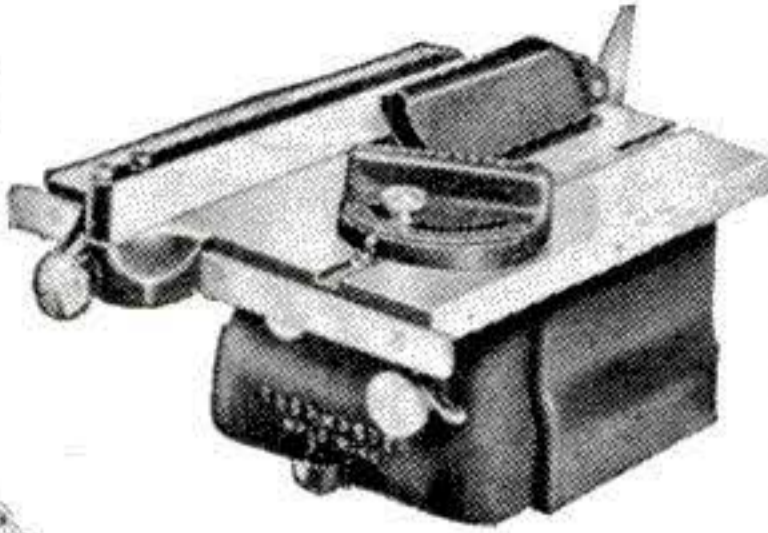

Satisfaction guaranteed.
8" Tilting Table Saw \$51.51
7" Tilting Table Saw \$33.95
All Prices Zone 2, slightly lower in Zone 1

Large working surfaces on all Shopmaster Saws.
8" Tilting Arbor Saw \$76.95
10" Tilting Arbor Saw \$86.95
10" Floor Model... \$105.00

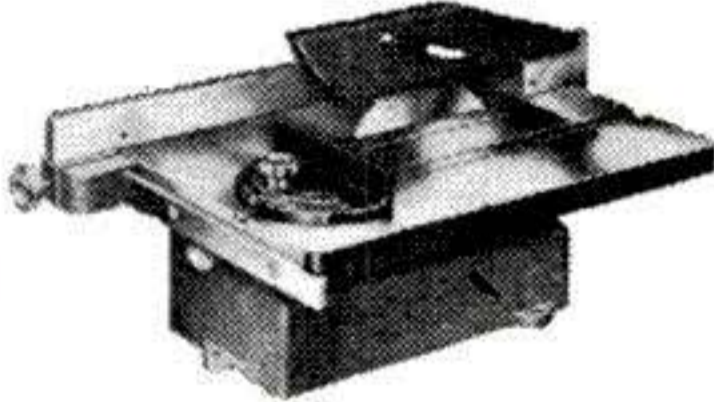

Write today for catalog of COMPLETE line

SHOPMASTER, INC.

1214 Third Street South • Minneapolis 15, Minnesota

Make Your Own POWER LAWN MOWER

with this DRIVE CUTTER ASSEMBLY

Constructed for those who desire to build their own mower or to replace your old cutter assembly. Complete with 18" blade and double ball bearing drive, only.....
Add 50c to cover handling & shipping. No COD's

\$12.95

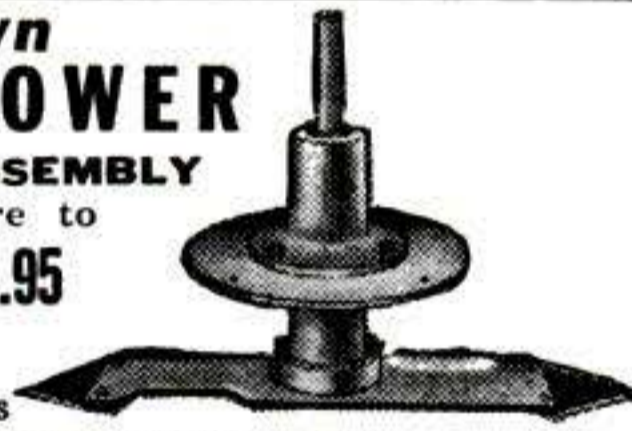

ATLAS EQUIPMENT CO., Dept. PS-1
229 SW BLVD. KANSAS CITY, MO.

DRAINS Cellars, Laundry Tubs; CIRCULATES Oil; IRRIGATES Gardens

Original "Type P" Pump has 2400 GPH capacity. 360 GPH 75" high, or 1500 GPH from 25" well. Use any 1/8 to 1/2 HP motor. DOES NOT CLOG. 1" intake; 3/4" outlet.

Only \$6.95 postpaid if cash with order. (West of Mississippi, add 50c.)

SATISFACTION GUARANTEED OR MONEY BACK!

LABAWCO PUMPS, BELLE MEAD 3, N. J.

\$6.95



1952
SPEED and POWER
FOR ALL CARS

SPEED & POWER

"SOUP UP"
ANY CAR

LEARN HOW TO GET 150 MILES PER GALLON WITH YOUR OWN CAR!

Fascinating construction drawings actually show how you can build fast stock cars, California roadsters, 200 MPH hot rods.

EASY STEP BY STEP METHODS help you save by building your own dual manifolds, superchargers, hot cams, water injectors, high compression heads.

LIGHTNING SPEED AND SUPER POWER

50 BREATH TAKING CHAPTERS TELL ABOUT: Tuning techniques, speed tricks, economy secrets, formulas for getting racing speed and dynamic power. Includes Information On: Racing frames, reciprocating masses, jet engines, wheel geometry, dynamometers. Photos and diagrams show how to restyle and customize all cars. Also info. on dual pipes, gears, fuels, porting, relieving, low-ering, balancing.

This great book... plus big 1952 "Speed Equipment Catalog" ... plus 46 page "Economy Driving Manual" ... plus \$1.98 "150 MPG Booklet" ... all four items ... ppd.

NEWHOUSE AUTOMOTIVE INDUSTRIES,
Dept. A-1 5807 E. Beverly Blvd. Los Angeles 22, Calif.

Burden's Gigantic Winter Clearance MAIL SALE

Midwest's leading surplus firm offers, subject to prior sale, a \$650,000.00 inventory of new perfect condition:

- ★ WAR SURPLUS
- ★ EXCESS INVENTORY
- ★ BANKRUPT STOCKS

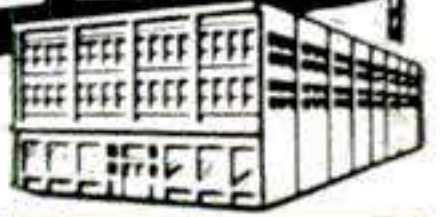

We Pay Shipping Charges in U.S.A. during sale



Power Plants and Generators

- Kato Generators. 5000-w, 115-v, 60-c, 1800 RPM. Single phase. Ball bearing. Complete with control panel, meters, pulley, etc. Cost over \$550. \$259.60
- Burdex Generators. 2000-w, 115-v, 60-c, 3500 RPM. Single phase. Ball bearing. Complete with control panel \$159.50
- Burdex Generators. Same as above, except 1000-w. \$134.90
- Burdex Generators. Same as above, except 500-w. \$94.50
- Onan Plants. 5000-w, 115-v, 60-c. Sing. phase, 4 cyl. water cooled eng. Push-button start. Cost over \$1200 \$715.50
- Homelite Plants. 500-w, 115-v, 60-c. Sing. phase 1-cyl. air cooled eng. Manual start. Cost over \$1100. \$597.90
- Homelite Plants. 1500-w, 115-v, 60-c. Sing. phase 1-cyl. air cooled eng. Manual start. Cost over \$465. Special \$259.50

Water Pumps and Systems

Finest units at big savings. Get expert advice on your pumping problem. Use pumps for wells, garden irrigation, basements, floods, spraying, septic tanks, etc.

- Centrifugal Pumps. BURDEX—Cast iron case, bronze impeller, stainless steel shaft. Ball bearing. 40 to 140 G.P.M. 5 to 30 lbs. pressure. Model #75, 3/4", \$18.90. #100, 1", \$28.90. #150, 1 1/4", \$35.60. ● Aluminum—stainless shaft with 2 1/2" pulley, threaded for garden hose. 30 g.p.m. Special, \$11.95. ● Allison Hi-Capacity—ball bearing. Double outlet, 2 1/2" inlet, twin 1 3/4" outlets. To 200 g.p.m., \$39.50.
- Rotary Pumps. Low pressure type—all bronze, stainless shaft, precision bearings. Flexible Hy-Car rubber impeller. Self priming to 10 ft. Lift to 22 ft. 6 to 20 g.p.m. 5 to 25 lbs. pressure. Model #12, 1/2", \$12.75. #34, 3/4", \$16.95. #10, 1", \$22.95.
- Hi-Pressure Type—same construction as above except has bronze rotor with nylon rollers. Pressures to 150 lbs. #612, 1 1/2", \$14.50. #63, 3/4", \$20.95. #610, 1", \$27.95.

Write for special Water Pump catalog, data.

Air Compressor Equipment

Paint, blow up tires, clean gas lines with compressed air. Build your own portable hi-pressure unit.

- Basic Compressor Kit. Finest 1-cyl. piston comp., stainless steel storage tank, 160 lb. gauge, paint gun, blow gun, fittings, tire chuck, hose, relief valve, inst. for portable unit . . . Air Reg. \$45.49
- Air Components. 1-cyl. compressor. . . \$20.50
- 2 cyl. comp. \$49.50. Automatic pressure switches (on 50, off 75) . . \$4.95, pressure regulator (0-150 lb.) . . \$2.65, gauges (60, 100, 160 lb.) . . \$1.89, tanks (small \$5.60, large \$9.95), air hose, 20' 1/4" with fittings. \$2.89, adj. safety valve. \$1.95, top quality paint gun, \$8.95, 3-gal. paint tank. . . \$18.95

Write for special Air-Compressor-Paint Spray catalog, data

Miscellaneous Surplus Bargains

- Tachometer. Direct reading. 0-4000 R.P.M. \$ 6.79
- Electric Chain Saw. 4 h.p. 30", one-man. 299.50
- Electric Carpenters Saw. 110-v, Cuts 2 1/8" lbr. 31.68
- Electric Drill. 1/2", 110-v, Hex chuck. 26.95
- City Up-right Desk Phone. Many uses. Instructions. 1.99
- Burglar Fire Alarm. 110-v outfits. 18.95
- Motors. Slow speed, 80 r.p.m. 110-v, 60-c. 8.95
- Motors. Hi-speed series, 6-12-v, D-C. 2.88
- Hydraulic Cyl. 3"x31". 19" stroke. 18.49
- W. E. Lip Microphones. Cost \$10.50.79
- Cathode Ray Experimental Tubes. 5". (905) 4.35
- Aircraft Bolt-Screw-Nut Mix, 6 lbs. asst. 1.99

Tractor Weed Spray Outfit

Winter Closeout. Leading make. Complete. 4-5 row, all brass T-jet boom, tractor direct-drive bronze gear pump, valves, hose, etc. Universal mounting. \$140 list. Save almost half in special sale. \$79.50

Guy Cable, Turnbuckle

New 12' 1/8" flexible steel cable, 14' turnbuckle. Guy or strengthen gates, fences, bldgs., television towers. Cost \$1.10 ea. 10—\$3.89. 50—\$16.47. 100—\$29.32.



Hand and Power Winches

- Boat, dock, utility hand winch. 1-4 gear ratio. All-steel. 1500 lbs. \$19.95
- Truck, farm, business hand winch, 1-3, 1-9 ratio, 3000 lbs. \$29.98
- Contractors heavy duty hand winch, 1-5, 1-27 ratio, 10,000 lbs. capacity. Brake, free wheeling. Easily arranged for motor drive. Most powerful hand winch made. \$89.95
- Hoist Winch. Drive with motor. Use for bldg. or contr. elevator, boat cargo un-loader, hay hoist, etc. Holds 1000' cable. Wt. 280 lbs. \$98.90
- Gar Wood Power Winch. Heavy duty. 15,000 lbs. Clutch. 150' 1/2" Hi-strength cable. \$179.50

ORDER FROM AD or Write for Free General Catalog!

BURDEN SALES COMPANY

823 "O" St.,

Lincoln, Nebraska

JANUARY 1952 257

A WHOLE WORKSHOP IN ONE KIT!

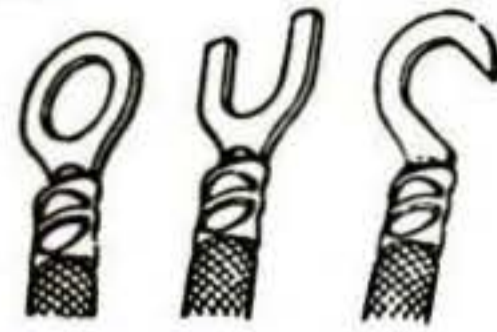
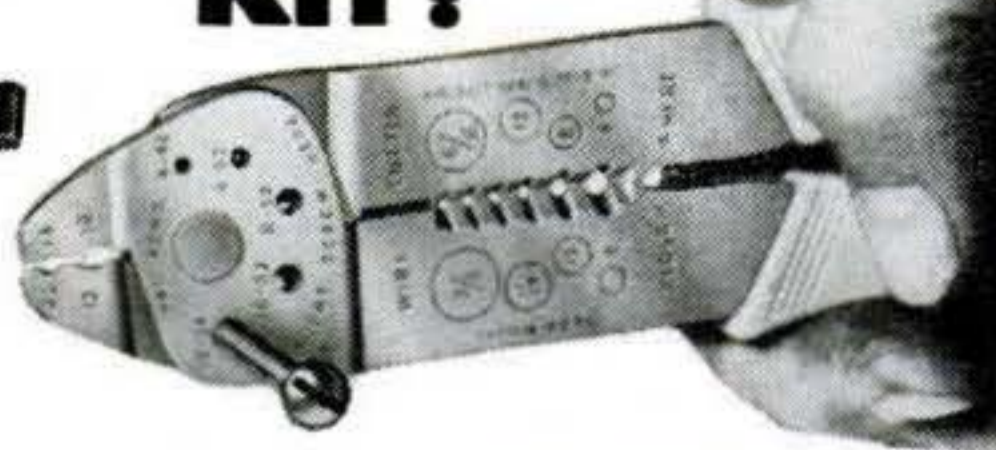
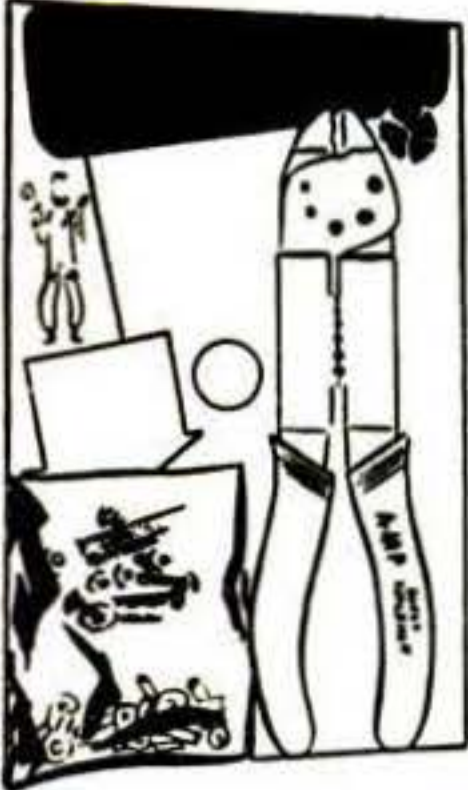

All for only
\$4.95

AMP
HANDY
DUTCHMAN
TRADEMARK

Order this unusual kit today! Gives you 5 tools in one that would cost from 3 to 5 times the price if bought separately. Kit includes a supply of bolts, nuts, washers, and terminals. Stud and wire size gauges are marked on tool.

Multi-purpose tool shears 5 popular bolt sizes—no fuss—no burrs to file! Use it to cut wire, strip wire, and crimp solderless terminals. Useful for hundreds of "handy man" jobs in home or workshop.

ATTENTION DEALERS:
TERRITORIES STILL OPEN

AMP

AIRCRAFT-MARINE PRODUCTS INC.
Dept. H.L. • 2100 Paxton Street, Harrisburg, Pa.

GET THIS
"How to do it"
BOOK **FREE!**



PARTIAL LIST OF CONTENTS

- "Better Painting"
- "Refinishing Antiques"
- "A Superb Furniture Polish"
- "Protecting Tools"
- "Waterproofing"
- "Finishing Gun Stocks"



Here are 101 useful ways to use America's finest 100% pure linseed oil. Perfect for painting and the handiest item for every housewife, homeowner and farmer. Available at all stores.

EARN \$2.00 EASY

We will pay \$2.00 for each new practical idea for using Pol-mer-ik Linseed Oil, which is acceptable to our research laboratory. Write Archer Daniels Midland, 604 Roanoke Bldg., Minneapolis, Minnesota.



REPLACEMENT OR REFUND OF MONEY
Guaranteed by
Good Housekeeping
IF NOT AS ADVERTISED THEREIN

ARCHER
Pol-mer-ik
100% PURE LINSEED OIL

SPEED-HEDS



HERE'S WHY SPEED-HEDS ARE 3 TO 5 TIMES FASTER



"SPEED-HEDS" never leave the nut as grip the nut precisely on same points! On worn nuts SPEED-HEDS ratchet in place. grin where socket wrenches slip!

SPEED-HED and standard wrenches must be removed and adjusted at every turn.

CAN'T SLIP! FULL TURNING POWER! GUARANTEED!

GZ1 3 pc. UTILITY SET 7/16, 1/2 and 9/16".....\$3.45
GZ2 5 pc. MASTER SET 3/8, 7/16, 1/2, 9/16 and 5/8".....\$5.90
GZ3 7 pc. SUPER SET 3/8 to 3/4" inclusive.....\$9.40



Compression Gage
This pocket comp. gage tests any motor. 20-120 lbs. Instruct. incl. GZ5.....\$1.95

Rubbing Block Surfacer
Smooths uneven breaker-arm rubbing block surface. Auto-Lite and Delco-Remy, 6 & 8 cyl. GZ4. Set of 2.....\$1.95

Carburetor Jet Puller
For tight jets. Screw into loosened jet. Slide-hammer does rest. Cart., Stromberg GZ6. Set of 2.....\$2.95

SCREW STARTERS—CAM ACTION

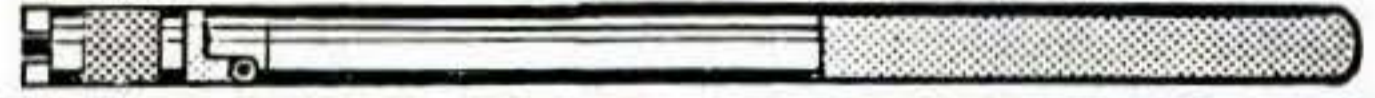

REGULAR ALUMINUM HANDLE Z-7 Supreme set of 4 2 1/2, 5, 9 & 15" long, 1/4" tips \$5.55
Nylon NON-CONDUCTOR HANDLE Z-8 Electronic set of 3 2 1/2, 5 & 9" long, 1/4" tips...\$4.45

SCREW STARTERS—SPRING ACTION



Z-9 Master set of 4 3, 5, 8 & 13" long, 1/4" tips..\$4.95
Z-10 Precision set of 4 3, 5, 8 & 13" long, 1/4" tips..\$4.95
(25% Deposit on C.O.D.'s. Add 3% Sales Tax in California)

Send now for LITERATURE illustrating hundreds of nationally known new and factory guaranteed time & labor saving automotive hand tools. Send 25c (refunded on first order) to cover postage, mailing, etc. Distributors wanted.
CENTRAL TOOL CO., 122 Golden Gate Ave., San Francisco, Calif.



1952 EDITION

It's New! It's Different! Get world's largest Auto Accessory & Parts Catalog and save money. Over 50,000 items, including Hollywood Accessories, Hi-Speed Equipment, Rebuilt Engines, all parts & accessories for all cars & trucks. We have that Hard-To-Get part! Jam packed with bargains. Completely illustrated. (100 pages) Send 25c (refundable).

J. C. WHITNEY,

1917-F Archer,

Chicago 16

MINIATURE

DUST MASK

Wear when sanding, grinding, sweeping, dusting, furnace cleaning. Handy as a pair of glasses. 9 sq. in. filter guards against harmful dusts, coal, cement, metal, lint, grain dust. Order today!

\$2

JERRY BRYANT

919 N. Michigan Ave., Chicago 11, Ill. Postpaid



ELECTRIC WELDER

AC or DC 110 Volts



"The Little Marvel" All-Metal welder. 5-year written guarantee. Welds 1/8" thick metal or money back. Repairs tanks, tools, fenders, machine parts, etc. Comes complete with everything—rods, unit, eye shield, and directions. We also make a welder for 16 to 22 gauge metal.....\$3.95 complete. Transformer welder kit \$15.95. On C.O.D., postage extra.

ESSAY MFG. CO., Inc., Dept. 47, Quincy 69, Mass.

\$6.45
Complete

REVERSIBLE MOTOR

115 V., 60 CY. AC.

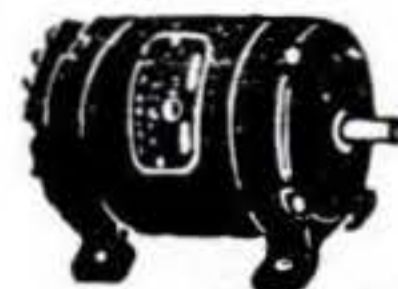

1/40 H. P. Ball-bearing, 1/4" shaft, 3450 R.P.M. in Blast Proof Case. Needs only a capacitor for starting. Manufactured by GE., Delco, Diehl.

SPECIAL LOW PRICE.....**\$4.95**

Lots of Ten or More \$4.00 Ea. ALL BRAND NEW.

STARTING CAPACITOR

For Above Motor Ea. 69c

TAPE

CANNED FRICTION TAPE, 3/4", 82 1/2 Ft. 6 Rolls to the Can \$1.25 per can

INDIVIDUAL BOXES

RUBBER TAPE, 3/4", 15 Ft. 15c per Roll
SCOTCH TAPE, 1", 50 Yds. 35c per Can
FRICTION TAPE, 3/4", 82 1/2 Ft. 15c per Roll
MICA TAPE 25c per Roll

Write for Free Booklet listing our stock and prices on Radio, Electronics, Tools, Hardware, Motors, Wire, Meters, Batteries, Aluminum Sheets, Etc. Minimum Order Filled, \$1.00. Please send cash with order. All items subject to prior sale.

STANDARD SURPLUS, Dept. S, 1230 Market St., San Francisco 3, Calif.

**EVERY 1/4" ELECTRIC DRILL
A PORTABLE SAW IN ONE MINUTE!**

**NEW! No. 445 "ARCO-SAW" for
DEPTH & BEVEL CUTS**

At
Better
Hardware
Stores
Every-
where

11.50
with

all GAGES & 4"
"HYCARBON"
Crosscut Blade.

No. 444 "ARCO-SAW", same as
above—less gages. Has accurate
visual guide. . . . **9.95**

No. 444G Depth-Bevel-Rip Gage.
Easily attaches to any No. 444
"ARCO-SAW" **1.95**

Extra "HYCARBON" Blades, 4"
Crosscut or 4" Combination **1.60**



ORDER TODAY at your dealer
or send us check or M.O. (Post-
paid). C.O.D.'s—postage extra.

DEALERS—Write
for nearest jobber.

ARROW METAL PRODUCTS CO

Dept. PS-1, 140 West Broadway, N. Y. 13, N. Y.

CAN BE USED WITH ONE HAND!
"ARCO-SAW" works like a
high priced Portable Saw.
RIGHT ANGLE GEAR DRIVE
eliminates clumsy, dangerous
direct drive with drill side-
ways.

**CUTS 1-1/4" or 2x4 by
turning over**

Depth gage graduated from 0
to 1 1/4" depth (for grooves,
dados). Bevel gage graduated
from 0 to 45° angle (for
dovetails, bevels). Rip gage
with sideways adjustment.
Visual guide with adjustment
to follow lines on both straight
and bevel cutting. **90-DAY
FACTORY GUARANTEE.**

**UNCONDITIONAL 10-DAY
MONEY BACK GUARANTEE**



**NONE
BETTER!**

SUPER DRILL GRINDER



Sharpens round shank drills from
3/32" to 1/2" in diameter, up to 6"
long. Grinds old drills like new in 4
different point angles, using hand
or power grinding wheels. Money-
back guarantee.

Price only **\$2.95**
At Dealers or Postpaid

Crandall Mfg. Co. 1512 W. Slauson, Dept.
S-1, Los Angeles 44, Calif.

POWERFUL MAGNET 1.95 P.P.

New type HIGH POWER permanent magnet (Alnico) will never weaken
in normal use. LIFTS 25 pound steel block! (Weights 34 lb.)
No electricity needed. RETRIEVES tools, tackle, etc. from under
water or other inaccessible places. REMOVES harmful nails, wire,
etc. from alleys, driveways or livestock paths. MANY other uses
listed. Quickly PAYS for itself. Try magnet AT OUR RISK; money
refunded if not 100% pleased. \$3 magnet NOW \$1.95
(No C.O.D.) Only 900 left. Larger sizes also available.
RONALD EYRICH, 1219 W. Meinecke Ave., Milwaukee 6, Wis.

VARIABLE SPEED HYDRAULIC POWER TRANSMISSION



It has Infinite Speeds 0 to 550 Reverse
Automatic Overload Protection; Adjustable
Torque up to 180 inch pounds. 5/8" Input and
Output Shafts. It will handle 1/4 to 1 1/2 H.P.
Motor. Case measures 7 1/2" long 7" high 6 1/2"
wide. VALUE OVER \$300.
Shipping Wt. 25#. On
C.O.D. Orders we require
a 10% Deposit. **only \$54.50**
Fob. Chicago

DIRZIUS MACHINE SHOP "V" 1423-25 So. 52nd Ave., Cicero 50, Ill.

ROTO-HOE

The Pioneer
Complete,
High Quality,
Low-Priced
Garden Tool

2 H.P. ROTO-HOE (as shown)
only \$134.00

A complete tool for the garden—Tills,
Cultivates, composts (also a portable
power unit)

YEAR ROUND ATTACHMENTS

- 20" ROTO CUTTER—for excellent lawn
care. (only \$40 extra)
- 12" TRIMMER-MULCHER (\$24 extra)
- 17" SNOW BLOWER—saves 75% time and
work on snow removal (only \$34.50 extra)

Ask your Dealer for a Demonstration.
Write today for FREE folder.

ROTO-HOE & SPRAYER CO.

Box 18

NOVELTY, OHIO

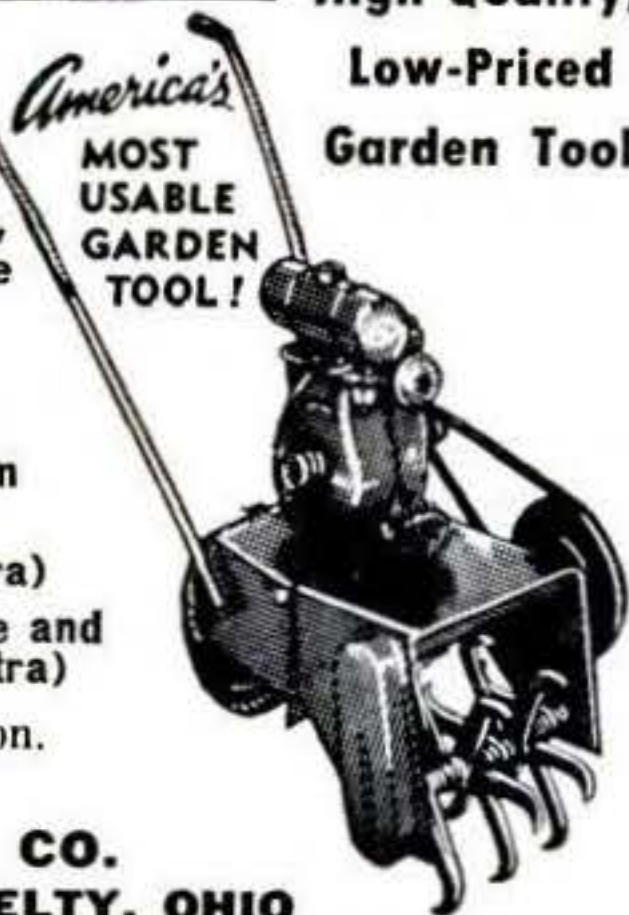

**OWN
YOUR BUSINESS**

**Start in Spare Time with a
FOLEY SAW FILER**

Here is a steady repeat CASH business you can
start at home in your basement or garage, while
you are working at your regular job. No experi-
ence is necessary to turn out perfect cutting saws
—"the first saw I sharpened came out 100%. I
think the Foley Saw Filer is a marvel of perfec-
tion," writes Clarence E. Parsons. Every saw you
sharpen will bring you new customers. You will
find you can make up to \$3 or \$4 an hour—\$20
to \$30 a week in your spare time as a starter.
With a Foley Saw Filer you can file all hand saws,
also band and cross-cut circular saws. It is easy
to operate—simple adjustments—no eyestrain.
Patented jointing principle evens up all irregular
teeth and makes an old saw cut just like new.

**This Free Book
Shows How to Start**

"INDEPENDENCE AFTER 40!"

shows you how to get plenty of saws to
file without canvassing, and how you
can develop into a general repair shop
that will be your own business. This is
a helpful, practical book that tells just
what to do—send for your free copy
today. No salesman will call.



Send For FREE BOOK

**FOLEY MFG. CO., 119-2 Foley Bldg.,
Minneapolis 18, Minn.**

Send me free book "INDEPENDENCE AFTER 40!"

Name

Address

SAFE JIG SAW

**CUTS
1" WOOD
QUIETLY!**



**... MAKE MONEY—START A
SPARE TIME, PROFITABLE BUSINESS
with THIS AMAZING, NEW, SAFE**

SYNCRO POWER SAW!

No. 201

Here's the most powerful saw of its kind! SYNCRO cuts 1" wood, thin metal, plastic. SAFE—blade does not pull finger toward it! Portable. QUIET—use even in apartments! Adjustable "any length cut" arm. With BUILT-IN New Reactance Type Electric Motor. \$22.95 at dealers or post-paid from factory. Dealers, Jobbers—write! Men who know buy SYNCRO!

**ONLY
\$22.95**

MOTOR INCLUDED
60 Cycle. 110-120
Volt AC

**MOST
POWERFUL
SAW
OF ITS KIND!**

SYNCRO CORPORATION
Dept. G-12, Oxford, Michigan



Dustite GASKET

**For Metal
Casement
Windows**

The Dustite gasket is designed with an extruded plastic sealing lip, to keep metal casement windows DUST TIGHT, STORM TIGHT, DRAFT TIGHT, RAIN TIGHT, and WIND TIGHT. Easy to install. Trial offer 50 ft. length with adhesive \$7.00—100 ft. \$13.00—200 ft. \$25.00. No C.O.D.'s please. Send check or M.O. Shipped postpaid in U.S.A. Sold under ten-day money-back guarantee.

**DUSTITE
PRODUCTS COMPANY**
6 CANTERBURY DR. • DAYTON 9, OHIO

**DEALERS WANTED
WRITE FOR FULL DETAILS**

U.S. GOV'T CLOSEOUT

**THIS WIRE
HAS NOT BEEN
OVERSEAS**

This high quality two conductor communication wire offered in No. 18 and No. 22 gauge is ideal for intercoms, lead-ins, telephones, indoor and outdoor speaker extensions, doorbells, signal and burglar alarm systems, shot firing, etc., etc. **SAMPLES ON REQUEST.**

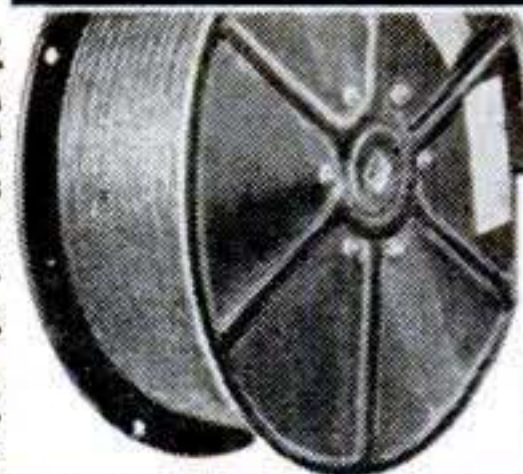

Wire

**U. S. Signal Corps
Communication Wire**
\$3.50 per 1000 ft. TWISTED TWO CONDUCTOR No. 22 STRANDED
\$3.50 TWISTED TWO CONDUCTOR No. 18 STRANDED per 1000 ft.

**Won't Last Very Long at These Prices
Stock Up Now — Subject to Prior Sale — Order Today**
W-110-B—TWO CONDUCTOR #18 STRANDED (four steel and three copper strands) rubber covered plus weatherproof cotton braid and twisted. 5,280 feet per steel reel. Only \$3.50 per thousand feet (3/5c per ft.) or \$18.25 per reel.
W-130—TWO CONDUCTOR #22 STRANDED and twisted (one copper and six steel strands) in your choice of rubber or plastic insulation. 10,000 feet per steel reel. Only \$3.50 per thousand feet (3/5c per ft.) or \$35.00 per reel.
(Note: Steel strands are incorporated for extra tensile strength and are tinned and treated for efficient conductivity.)
All these way below market prices, our stock will not last long. Take advantage of this exceptional closeout and **STOCK UP NOW!** Minimum order—one reel.

Prices F.O.B. Chicago. Include approx. postage on orders paid for in advance. C.O.D. orders enclose 25%, balance sent C.O.D. WRITE FOR FREE ILLUSTRATED CIRCULAR.

U. A. S. Corp. Dept. PS-1, 5637 W. 63rd Pl. Chicago, Ill.

ELECTRIC SHEAR SHARPENER

Over 75,000 Sold—It Must Be Good



Genuine Carborundum wheel ideal for shop or home use. Motor driven. Send remittance with order and shipment will be made at once, prepaid to your door, complete with electrical goods catalogue. **\$9.75** complete with vise

WILLIAM MARVY COMPANY, Dept. 14
479 St. Peter Street St. Paul 2, Minn.

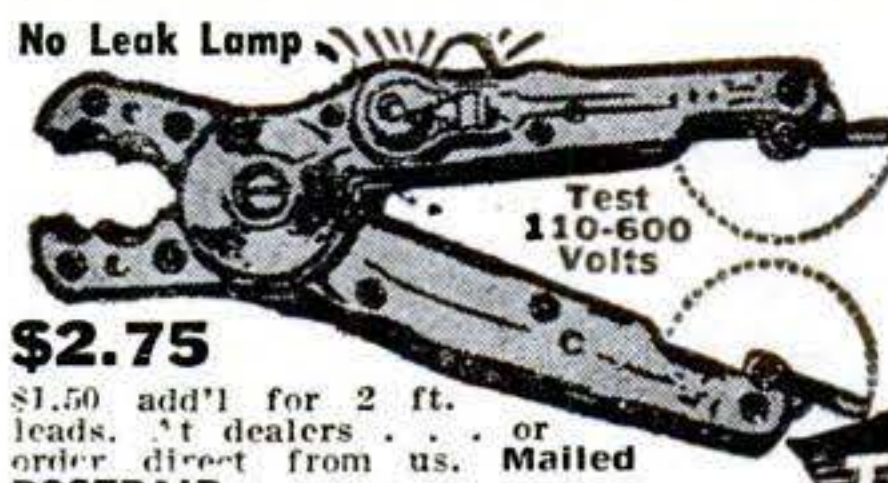

TEST Circuits, Fuses, Outlets easily, quickly, safely. Shockproof. Pull fuses 10 to 100 Amp.

\$2.75
\$1.50 add'l for 2 ft. leads. At dealers . . . or order direct from us. Mailed POSTPAID.
STAR TEST-PLIERS
STAR FUSE CO., 237 Canal St., New York 13, N. Y.

BUILD AN ARC WELDER FROM OLD GENERATOR
WE SHOW YOU HOW
Light or Heavy Work
Produces 75-200 amperes. Takes no previous experience or hard work to make one of these welders. Complete plans 35c. Send for your **PLANS** today and we'll include **FREE** our Big NEW Catalog listing hundreds of electrical bargains.
LEJAY MFG., 1323 LEJAY BLDG., MINNEAPOLIS, MINN.

WEATHER-PROOF YOUR CAR...

LIKE THE NEW

CADILLAC, FORD, HUDSON, CHRYSLER, Etc.
Drive thru rain, snow, puddles, protected by **SEALTIGHTS**—the original ignition weather-proofing insulators.

SEALTIGHT IGNITION INSULATORS
AMERICA'S FINEST INSULATORS!
Weatherproof, short-proof all cars, trucks, tractors, gas motors with Sealights on spark plugs, distributor, coil, magneto. ASK YOUR GARAGE or SERVICE STATION, or write us for details, giving make and model of car.
SEALTIGHT CORP., Dept. PS12, Cedar Rapids, Iowa

NEW 1952 KING MIDGET

WORLD'S
LOWEST PRICED
2 PASS.
AUTO

NEW PRINCIPLE OF ENGINEERING
FOR SMALL CAR PERFORMANCE



Drive it for
75¢ PER WEEK

• Amazing performance. Surprising comfort. All steel construction. Full accessories, top and heater. Ready to run or assemble it yourself with our bolt together parts. Rider agents wanted, earn your car Free. Send 25c for detailed literature or \$1 (refunded first order) for actual assembly book and service manual filled with photos, drawings, specifications, etc.

MIDGET MOTORS MFG. CO. Athens, Ohio

ONE-MAN SAWMILL LOW \$50⁰⁰ DOWN AS...



Take BELSAW Portable Sawmill right to the trees—turn out valuable lumber for local yards—do "custom sawing" for neighbors. BELSAW lasts a lifetime. No crew needed. Power with old auto engine. Beginners get excellent results. Send postcard for FREE BOOK, "How To Make Lumber."

FREE BOOK

BELSAW MACHINERY CO
8463 Field Bldg. Kansas City 2, Mo.

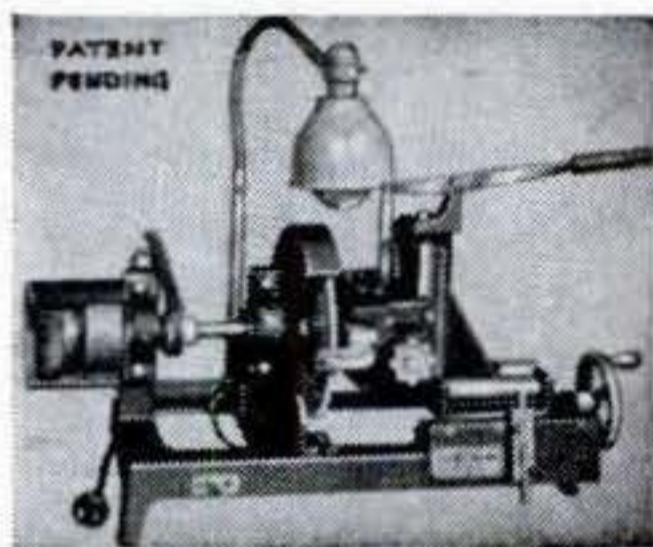

Start a NEW BUSINESS!

or Add to your present
Repair Business

SHARPEN DULL PIPE WRENCHES

PIPE TAPS & DIES
"GUM" CIRCULAR SAWS

Write for Information

J. C. MOORE INDUSTRIES
BOX 5 276, Fredonia, Pa.

\$750 BUILDS 4 ROOMS & BATH!

WHY PAY RENT?

For Seven Hundred Fifty Dollars and 30 days of your spare time, you can build yourself this Beautiful Home. Living room 11x15. Front bedroom 9x11. Back bedroom 10x12. Kitchen 9x11. Bath 5x8. Hall 3x4. Wind out steel Casement windows. Concrete block, stuccoed. \$1.00 brings you Step-by-Step Instructions, Blueprint & Material List.



L. H. FARROW, Dept. D
Box 645 Columbus 16, Ohio



Thousands
In Use

SMALL! POWERFUL!

America's finest low cost tractor. Ruggedly built. Easy to operate. No belts, no chains. Borg-Warner clutch, trans. and diff. 140 to 1 reduction. 40% more drawbar pull than ordinary tractors. 8-1/4 H.P. engine—gasoline or kerosene. 20 quick change implements.

Write for complete details.
ENGINEERING PRODUCTS CO.
915-A1 Niagara Ct.,
Waukesha, Wis.

FREE

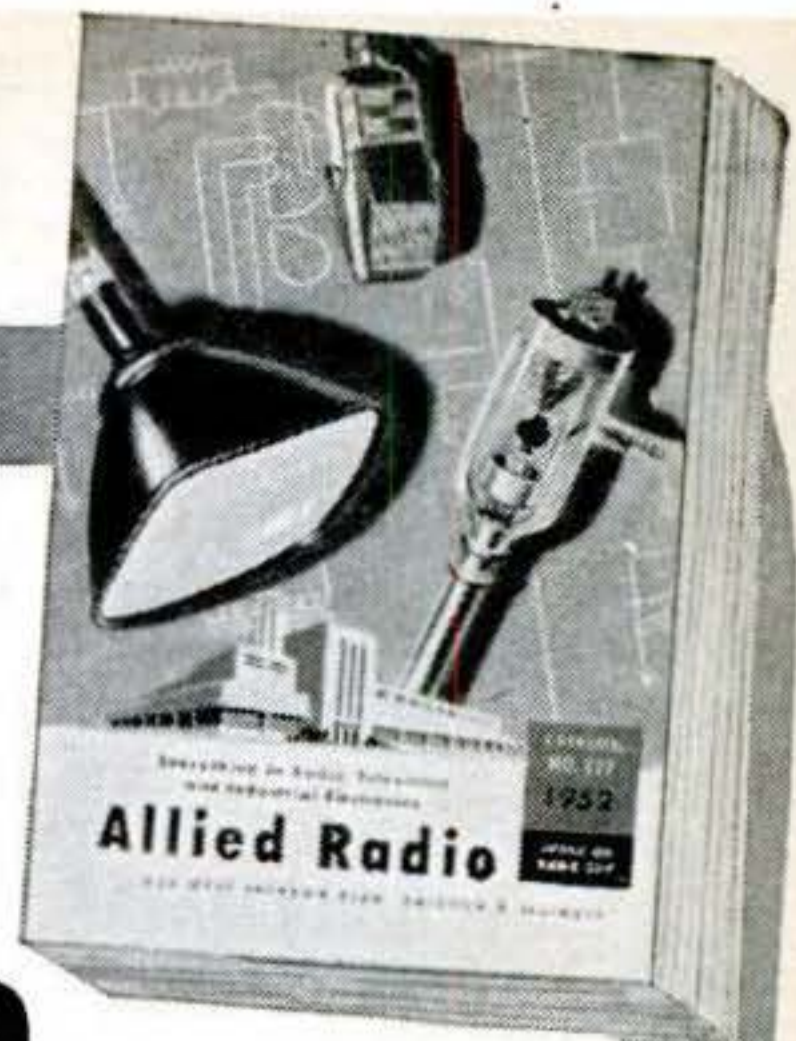

★
1952
ALLIED
RADIO & TV CATALOG
EVERYTHING IN RADIO
AND TV AT LOWEST PRICES!

SEND FOR IT

212 PAGES
Value-Packed

Everything for
Experimenters, Builders, Amateurs,
Servicemen, Engineers, Soundmen...

Save money on every Radio and TV need! Get the big 212-page 1952 ALLIED Catalog featuring the world's largest selections of top-quality electronic equipment at lowest, money-saving prices. See the latest in TV, home radios, Amateur equipment, P.A. systems and Hi-Fidelity custom sound, recorders, test instruments, builders' kits—plus thousands of parts, tools, books and diagrams. Get more for your money from the World's Largest Radio Supply House. Send today for your FREE 1952 ALLIED Catalog!



Save on
Everything
in Radio & TV



FREE
CATALOG

SEND FOR IT TODAY

ALLIED RADIO

ALLIED RADIO CORP., Dept. 7-AA-2
833 W. Jackson Blvd., Chicago 7, Ill.

Rush FREE 1952 ALLIED 212-Page Catalog

Name _____

Address _____

City _____ Zone _____ State _____

300 Power Import MICROSCOPE \$14.95

Laboratory Model **postpaid**

Triple revolving turret holds 100 power, 200 power and 300 power lenses! No frills, just excellent optical qualities, delicate adjustment, solid construction. Its quality and price astounded biology instructors. A lifetime bargain for students, schools, labs, research, amateurs. *Anyone can now own one.* (Performance cannot be duplicated for \$75.00)

FEATURES: Fine micro adjustment, adjustable plano substage mirror. Dovetail hardwood case included free. If you are not amazed by its quality, send it back in 10 days. Your money refunded immediately. Send check, cash or money order for \$14.95.

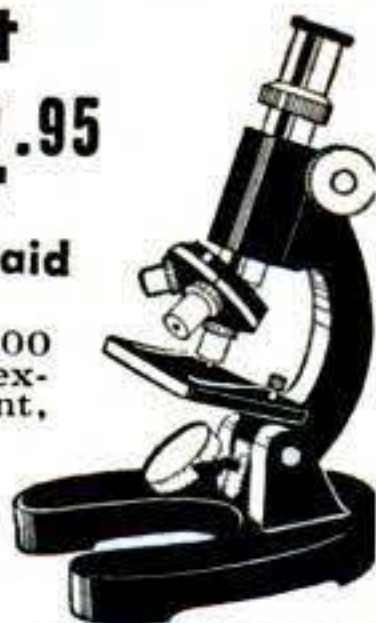

100 POWER IMPORTED MICROSCOPE \$5.95

& Complete 12-Pc. Kit **Postpaid**



12-Piece set includes full 100 power adjustable focus imported microscope with adjustable plano substage mirror, four blank slides for your own specimens, one small inspection magnifying glass, one eye dropper, one pair tweezers, one tickler, two specimen holders

with tops, one sturdy field case. A wonderful gift for all occasions. Sent postpaid complete \$5.95!

8X COATED PENSCOPE \$4.95

postpaid



Pocket telescope fits in your pocket with clip like fountain pen, extends to form a powerful scope for spotting game, watching sports events, etc. 8 Power coated lens, more powerful than standard army binoculars. A special bargain at this low price.

Money-back 10-day guarantee on all items. Send check, cash or M.O. Free catalog on request or included with order. Calif. residents add 3% state tax.

20, 40, 60 Power Pocket MICROSCOPE



Select whichever power you want, then focus to pinpoint sharpness with spiral ring. Finest optics, amazing versatility. A compact new precision instrument for \$4.95 field study. Postpaid.

AKRON ARMY-NAVY STORES 4400 Sunset Blvd. Dept. 1-S
Los Angeles 27, Calif.

WHY NOT SAVE GAS?

Try Ganes At Our Expense



**BOOK
GIVEN FREE
TO ALL WHO TRY
GANE NEEDLES**

GANES REPLACE CARBURETOR
IDLING ADJUSTMENT SCREW

Install Ganes in a few
minutes on all cars

HOW TO GET
**150
MILES PER GAL**



**10 DAY
FREE TRIAL
IN YOUR CAR**

TEST FOR
✓ BETTER MILEAGE
✓ EASIER STARTING
✓ FASTER PICKUP
✓ BETTER IDLING

MANY GANE USERS REPORT UP TO 25% MORE MILEAGE AND ALL-AROUND BETTER PERFORMANCE . . .

but don't take our word for it . . . see for yourself! Test Ganes in your car for 10 days **AT OUR EXPENSE**. Then, compare your mileage and performance and, if fully satisfied, pay only \$1.50 per needle (8 cylinder cars use 2). If not satisfied, simply return them and owe nothing . . . fair enough? Since authorities differ on the merits of Ganes, and some users report no improvement, **TRY BEFORE YOU BUY!**

ALSO FREE . . . Auto Economy Manual—SENT ABSOLUTELY FREE TO ALL WHO TRY GANE NEEDLES, tells how to save fuel, tires and brakes; how to obtain more speed, power and better performance from any car. Also introduces many new, ingenious auto economy products.

**WRITE TODAY! ENCLOSE NO MONEY!
PAY POSTMAN NOTHING!**

List your name, address, make and year of car, no. of cylinders and make of carburetor if known. **YOUR TWO FREE BOOKS AND GANE NEEDLES WILL BE SENT IMMEDIATELY.**

**NATIONAL AUTOMOTIVE RETAIL CORP., Dept. H-1
350 W. Washington Blvd., Venice, California**

Stucco Spraying Can Be Your Opportunity



You can build a profitable, lifetime business with Colorcrete. Large waiting market. Work is easy and interesting. Moderate investment; high return. Large waiting market. Full instructions and liberal co-operation.

Sprayed-On Beauty

Colorcrete is modern beauty treatment for masonry surfaces—exterior and interior. Fuses to concrete, stucco, etc. Applied by air pressure. Range of many smart colors. Proven by 20 years of use on all kinds of buildings.

Write or wire for
*Opportunity
Book.*

**COLORCRETE
INDUSTRIES, INC.
572 Ottawa Ave.,
Holland, Mich.**



FREE! Plans Show How To Build A

POWER MOWER



Also Plans Build a Gasoline Type That
Pulls and Steers Itself!

Save time and work cutting grass and weeds—Build a whirl blade power mower, cheaply without special tools or equipment. Send postcard for FREE building plans.

For As Little As

\$19.95

Whirl
Blade

Electric Less Motor
WRITE TODAY

T & H Mfg. Co., 811 E. 31 St., Dept. 211, Kansas City, Mo.

DRIVE 3 TO 6 DAYS A MONTH

FEBRUARY						
S	M	T	W	T	F	S
				1	2	3
4	5	6	7	8	9	10
11	12	13	14	15	16	17
18	19	20	21	22	23	24
25	26	27	28			



Gas Free!

Users claim and exhaustive tests have proved that the REMARR AUTOMATIC GASOLINE INJECTOR saves up to 20% on gas, boosts power and pick up on all cars, light trucks and tractors. Install it easily and test for 30 days on your car. **IF NOT COMPLETELY SATISFIED, RETURN FOR FULL REFUND.** List your name, address, car make, year, model and no. of cylinders. **Free Literature on Request \$9.95 Postpaid. \$1 C.O.D. Deposit**
G. B. SCHUYLER, Dept. 71, 2804 10th Street, Berkeley 2, California

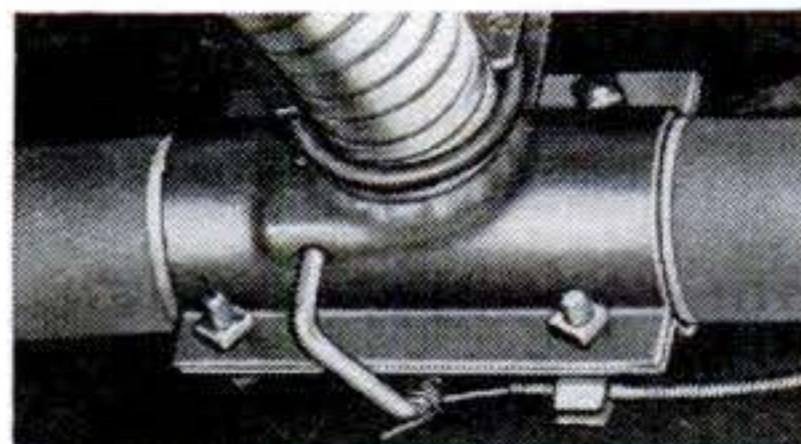

HURRICANE EXHAUST CUT-OUT

This specially engineered cut-out enables you to install special pipes and mufflers without removing the original muffler.

Now control your exhaust tone from a dash control button. Cut back into your original muffler in restricted areas at will.

This cut-out is well constructed; actually strengthens exhaust pipe; made of heavy plate steel, designed for easy installation—no special tools required. Fits all exhaust pipes from 1 3/4" to 2 1/4" size. Sent postpaid for only \$6.95 check or money order. Satisfaction guaranteed or your money back.

ST. LOUIS PRODUCTS CO., Box 24-B, Normandy 21, Mo.



GRAVELLY makes tough jobs EASY!



5-HP Gravelly Tractor powers 20 tools—does every lawn, garden, field job easier, better! All-gear drive, Reverse. "Power vs Drudgery" Booklet FREE. Write for it today!

GRAVELLY MOTOR PLOW & CULTIVATOR CO.
BOX 184 DUNBAR, W. VA.

FIELD-TESTED FOR 30 YEARS

USE YOUR BENCH SAW

FOR JOINTING & CUTTING MOULDINGS

With our six inch tool steel cutters make mouldings, casings, drop-leaf tables, grooves beading and jointing. Moulding cutters, A 1 in. wide \$1.75, 1 1/2 in. \$2.25. Jointing cutters, B 1 in. \$1.75, 1 1/2 in. \$2.25. E 1 in. for drop-leaf tables. \$1.75. E 1 1/2 in. Makes 3/4 in. cove & Quarter. \$2.25. Postpaid. Guaranteed. State size hole. List & Folder free.

JOHN A. SANDSTROM
 Rt. 2-P. Clearwater, Fla.

NO PARTS TO FLY OFF!!

SILVER SOLDER TORCH & KIT \$7.50

Joins All Metals Permanently
 EQUAL TO WELDING FOR MOST PURPOSES

Ideal for Repairmen, Hobbyists, etc. Kit includes one tube silver solder flux and 10 5-in. lengths silver solder alloy. Hottest ALCOHOL TORCH known. 2700° F. flame. Operates in any position, indoors or out. Pint of special fuel included. TORCH alone with pint of special fuel \$6.50. KIT alone \$1.50. Complete instructions included. Add 35c on each order to apply towards shipping charges.

AMERICAN PRODUCTS CORP., 422 S. Dearborn St., Dept. 2-A, Chicago 5

Print Your Own

Cards, Stationery, Advertising, labels, circulars, photo and movie titles, church work, tags, etc. Save money. Sold direct from factory only. Raised printing like engraving, too. **Print for Others, Good Profit.** Have a home print shop. Easy rules supplied. Pays for itself in a short time. Write for free catalog of outfits and all details.

KELSEY PRESSES, N-33, Meriden, Conn.

FIRING FORGING MELTING

UTILITY OIL BURNER
BUILD KILNS, HEARTH & CRUCIBLE FURNACES, FORGES

SAVE TIME AND MONEY

Do your own FIRING, BAKING, DRYING, HARDENING, BRAZING, ASSAYING, CASTING, FORGING, GENERAL REPAIR AND PLUMBING WORK. Construction plans included. Cut costs tremendously. Burns kerosene, #1 or #2 fuel oil with a clean hot flame; fires in open or into furnace; controllable atmosphere. Up to 3000°F. A neat, compact, portable unit ready to operate. Capacity 1/2 to 1 1/2 gals. per hour. Wide heat range. 26" x 10" x 9"; 22 lbs. 110 v., 60 cycles.

Write for information. Tell us your requirements. Immediate delivery. Price \$89.50 FOB factory. Satisfaction guaranteed.

STODDARD PRODUCTS CO., Inc., 66 Amity Road, New Haven 15, Conn.

IT'S NEW! IT'S SENSATIONAL! FIRST TIME EVER OFFERED!

BIG 8-inch TILT-ARBOR SAW

BLADE TILTS TO 45 ANGLE! TABLE STAYS LEVEL!

Save \$20 to \$40!
 Compare with Power Saws selling for much more that do the same job! You'll be amazed!

It's Sturdy!
 It's Substantial!

ALL METAL

PRECISION GROUND AND POLISHED!

Blade Tilts to 45° Angle!
 Patented Motor Mount for Permanent Belt Tightness!
 Self-Aligning Rip Fence!
 Accurate Tilt Scale!
 Single Hand Wheel Control!

Saw Throat Insert Removable for Dadoing!
 Index Miter Easily Adjusts! To Any Angle!
 Operates on either 1/4 or 1/3 H.P. Motor! Even a washing machine motor will run it!

Height lock for Dadoing! Planetary Saw Tilt! Ball Bearing Floating Drive! Blade Raises and Lowers!

For Farmers! Mechanics! Carpenters! Home Hobbyists!

Miter Saw
 Rip Saw
 Cross-Cut Saw

Cuts Dadoes and Mouldings!
 Blade Tilts to 45° Angle
 Patented Motor Mount

CUTS 2"x6s" in 2 1/2 SECONDS!

Rarely before have you been able to buy a power saw of such fine quality at the amazing low price of \$19.95. It cuts hard or soft woods up to 2 1/2 inches thick! Cuts joists, siding, rafters! Miters and bevels! Accurately rips wide or narrow panels! With attachments, cuts dadoes, and mouldings! Makes frames, joints, slots, etc.

Add \$1.00 for Postage! Mail Check or Money Order to **YOLANDS, Dept. PS2, 20 Boylston St., Boston 16, Mass.**

15-inch Swing

Four inches more than other heavy-duty lathes. 33" between centers. Extra features. Compare **SHOPSMITH!** It's a saw, sander, vertical and horizontal drill, too. Write for free catalog.

SHOPSMITH, Dept. 180-A
12819 Coit Rd., Cleveland 8, O.

AMAZING TOOL BARGAINS!

ALL BRAND NEW MERCHANDISE
112 PIECE ASSORTMENT \$3.95
FOR ELECTRIC GRINDER \$3.95 PP.

\$10.00 VALUE—ONLY

Here's what you get! Mounted Stones on 1/8" mandrel, Drum Sander, Sanding Sleeves for sander, Rotary Cutters, Wire Scratch Brush, Bristle Brushes, Circular Saw, Buffing Wheel, Grinding Wheel, Rubber Polishing Wheel, Cut-off Wheels, Rubber Cylinder, Mandrels to fit above tool, asst'd. Sanding Discs, Sharpening Stone, etc.

ABRASIVE CLOTH ROLLS — 50 Yd. Lengths

5" wide—320 grit.....	\$8.00
2" wide—150 grit.....	\$3.50
2 1/2" wide—400 grit.....	\$3.50
1 1/2" wide—100 grit.....	\$2.75
5/8" wide—50 grit.....	\$1.75

12 MOUNTED WHEELS and points on 1/8" Mandrel. For grinding on plastic. **\$2.95 PP.**

wood, soft and hard metals. Reg. \$8.40 List Val. 12 wheels on 1/4" Mandrel **\$3.60**

18 MOUNTED POINTS ON 3/32" MANDREL \$2.50

SCHUPACK SUPPLY CO., 7331 Cottage Grove, Dept. S-12, Chicago 19, Ill.
 (NEW 1952 Illustrated Catalog 10c)

best
white tape
made

ONLY
98¢*



The new "Evans White-Tape" has everything you'll find in tapes costing over \$1.50—plus.

- snow-white blade with bold, legible, jet-black numerals and graduations. Graduated in 32nds for first 6 inches.
- sturdy die-cast case heavily chrome-plated, calibrated for quick reading inside and outside measurements.
- blade 1/2" wide made of finest high carbon steel—tempered—Bonderized—enamelled—baked.
- blade replaceable in seconds—without tools—without even opening case. And Evans replacement blades cost far less.
- every "Evans White-Tape" is unconditionally guaranteed.
- exclusive Evans automatic brake gives smoother push-pull action with absolutely no "creeping" of tape into case.
- underside is white, too. Mark with ordinary pencil, remove mark with flick of thumb.
- unheard-of low price*: 10-ft. \$1.49; 8-ft. \$1.19; 6-ft. 98¢. Prices higher in far west and Canada.

Evans & CO Elizabeth, N. J., Montreal, Que. 7429
Makers of Evans 6-ft. Folding Rule and "Folding Yardstick"

Sold only through retailers.

START A BUSINESS this quick way

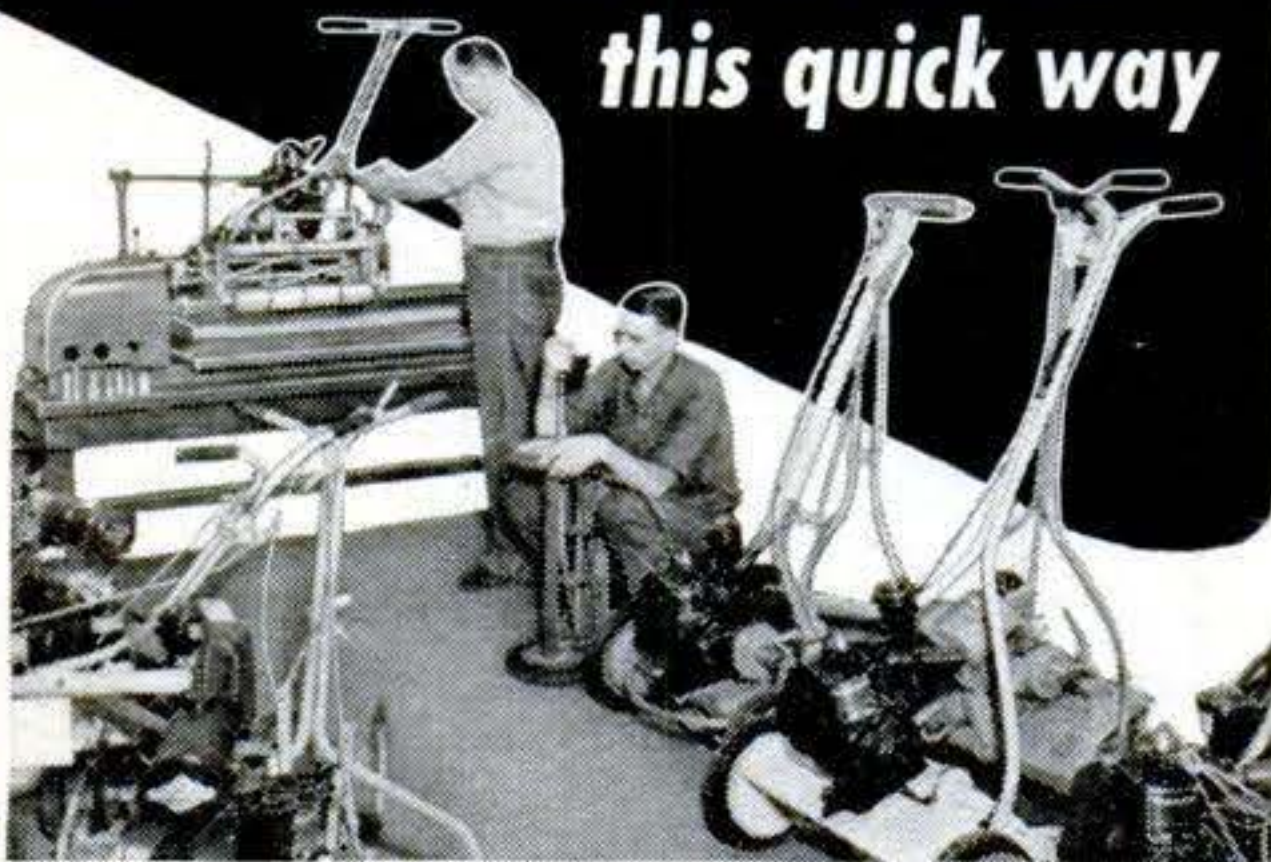

with FOLEY LAWN MOWER SHARPENER

"I have taken in 100 mowers in 5 weeks since I got my Foley,—with no advertising," says George C. Wise. "In two months I have sharpened 155 hand mowers, 6 power mowers and 1 trimmer. My machine has paid for itself and everything I take in now is all profit"—from Otis Zacharia.

Here's a business you can start in spare time, and begin to make a CASH PROFIT right away. The Foley handles up to 3 or 4 mowers per hour, and prices run \$1.50 to \$3.00 for hand mowers, \$5.00 to \$8.00 for power mowers.

FREE—VALUABLE 33 P. BOOK shows how to sharpen power mowers. Foley prices are low—easy payments available. Mail coupon today—we'll also send FREE PLAN telling how to start your own business without previous experience. No salesman will call.

FOLEY MFG. CO.,
108-2 Foley Bldg., Minneapolis 18, Minn.
Send FREE BOOK "How to Sharpen Power Mowers," and FREE PLAN on lawn mower business.

NAME.....

ADDRESS.....

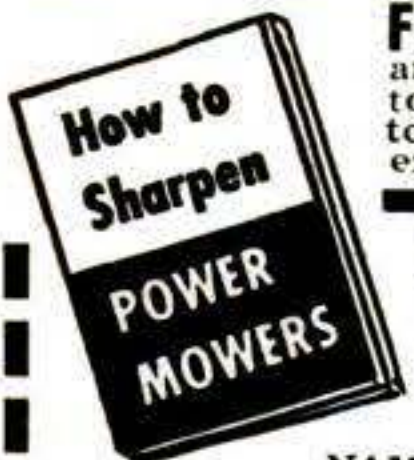

CHAMPIONS

CHOICE of the EXPERTS

for

Dependability, Performance
and Long Life

INSIST ON CHAMPIONS
FOR YOUR CAR!



CHAMPION SPARK PLUG COMPANY, TOLEDO 1, OHIO

SHEET METAL BRAKES

Forms angles, flanges and Pittsburgh locks, 26 gauge steel, heavier aluminum. Cam locking. Portable. can be bolted to bench, or clamped to edge of truck. All steel, reinforced. Shipped Exp. Coll. 30" size. Wt. 54 lbs., \$26.50. 36", Wt. 66 lbs. \$31.00. 48", Wt. 100 lbs., \$45.00. Floor mountings, portable, 32" high, 30 lbs., \$7.00. 12" BRAKE. Fits in vise to form difficult compound bends, up to 20 gauge steel. Not illustrated.....\$12.50 P.P.



HYDRAULIC PRESS BRAKE forms 1 1/2x4, or 1 1/4x2-in. 3/4" Pipe Bender and Bar Bender and Straightener up to 1/2" thick, and forms various small parts in heavy steel. Uses your 5 ton jack, \$18.50.
24" CURVE FORMER, 2 roll, 16 gauge, 2" to 2' dia...\$10.00 P.P.
IRON BENDER, 1/4x2" capacity, 10 parts. All steel...\$10.00 P.P.
Immediate delivery. Order direct, cash or C.O.D. or send for folder.
VYKE BRAKE CO., S-1116 So. 27th St., Omaha 5, Nebr.

END GENERATOR TROUBLE REGULATOR BATTERY REPLACE VOLTAGE REGULATOR WITH AMAZING NEW WATTAGE GREATEST ADVANCEMENT IN AUTO IGNITION SINCE THE SELF-STARTER

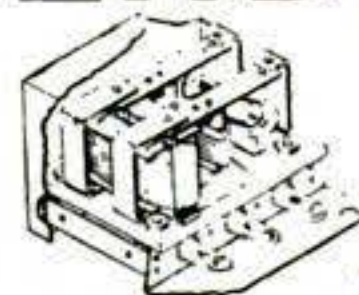

DRIVE WITH OR WITHOUT BATTERY
100,000 MILE MONEY BACK GUARANTEE

STATE MAKE AND MODEL OF CAR AND SEND FOR FREE CATALOG

SCIENTIFIC ELECTRIC CO. P.O. BOX 2162P2 STA.H Cleveland, OHIO.

BOYS! MAKE YOUR OWN RADIO



Make your own simple, tubeless, batteryless Crystal Radio. SEND 25c for a GENUINE MELOMITE CRYSTAL with complete illustrated instructions for making your own set. Crystal sent postpaid with instructions and our own publication, "THE MAGIC CRYSTAL" which is full of news, diagrams, questions and answers of interest.

SEND 25c FOR YOUR CRYSTAL TODAY!

ALVA ALLEN RADIO Dept. PS-1 Clinton, Mo.

Home Workshop Fans— Save 57%!

New 512-page "Mammoth Home Workshop & Home Repair Manual," published to sell for \$6.98, yours for only \$2.98! Easy directions, 1671 pictures show things to make do with tools. Save money on home repairs, plumbing, masonry, carpentry, more! Order TODAY!

POPULAR SCIENCE MONTHLY

Dept. 152, 353-4th Ave. New York 10, N. Y.

WELD
BRAZE, SOLDER,
and CUT →

ONLY
\$1475
F.O.B.
complete!



No experience needed. Follow simple instructions, weld on iron, steel, bronze, brass, aluminum, and other metals. Plugs into any properly wired 110 volt A.C. or D.C. line. Make or save time and money doing repair work for yourself and others. Repair men, farmers, tin-smiths, home and auto owners, hobbyists, etc., say FOUR-WAY pays for itself over and over. Order today or send for Free details.

FOUR-WAY WELDER COMPANY, Dept. F3-AC
2326 So. Michigan Ave. • Chicago 16, Illinois

LARGER EQUIPMENT AVAILABLE ON REQUEST

ORDER
NOW
10 DAY
TRIAL

SURPLUS MACHINE SHOP TOOLS AT PRICES YOU CAN AFFORD

SET H. S. STRAIGHT SHANK DRILLS.
10 different sizes; 1/4" to 1/2".
7W lengths up to 7". New and used.
Shank diameter same as drill. **\$3.98**
only.....

HIGH SPEED DRILLS

1/4" to 1/2" with 1/4" Shanks
1/2" to 1" with 1/2" Shanks

SET 6 Different Size H.S.
35W Drills, 1/4" to 1/2" all
with 1/4" shanks **\$3.50**

SET 10 of
36W above **\$4.95**
Set 35W and 36W will fit
any 1/4" drill.

SET 5 Different Size H.S.
32W Drills, 1/2" to 1"
with 1/2" shanks **\$6.95**

SET 10 Different Size H. S. Drills, 1/2"
to 1"
33W with 1/2" shanks..... **\$12.95**

These new and used H. S. precision drills
with 1/2" shanks can be used in a 1/2" elec-
tric drill or a 1/2" capacity lathe or drill press.

HIGH SPEED MORSE TAPER SHANK DRILLS

SET 15 different size High
Speed Morse Taper
Shank Drills up to
9/16", with No. 1 and
2 tapers. New and used.
\$50 value. **Priced at only \$6.49**

SET 20 different size
High Speed
Morse Taper
Shank Drills from 1/4"
to 1". New and used.
\$70 value. **Priced at only \$12.95**

SET 10 Different Size High Speed Morse
Taper Shank Drills from 1/2" to 1 1/4".
New and used. \$50 value. **\$9.95**
Priced at only.....

SET 8 Different Size High Speed Morse
Taper Shank Drills from 1" to 2"
with No. 3, 4, and 5 tapers. New
and used. \$125 value. **Priced \$29.95**
only.....

High Speed Woodruff Key Seat Cutter

SET 5 different size cutters. Can
4W be used as mounted milling
cutter or circular saw. All
with 3/8" and 1/2" shanks.
widths up to 1/4", dia. up to
1". New and used. **\$3.95**
Priced at only.....



HIGH SPEED STRAIGHT SHANK

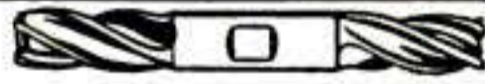

DOUBLE-END END MILLS

SET 4 Right hand twist 7/16 shank end
mills, size 5/16 to 7/16.
29W Used surplus only..... **\$3.95**

HIGH SPEED TAPER SHANK CHUCKING REAMERS



SET 15 Different Size High
Speed Morse Taper Shank
25W Chucking Reamers up to
1/2" with No. 1 and 2 tapers.
New and used. **\$6.95**
Priced at only.....

SET 8 Different Size High
Speed Morse Taper Shank
13W Chucking Reamers from
1/4" to 1". New and
used. **Priced at only \$4.95**

SET 10 Different Size High Speed Morse
Taper Shank Chucking Reamers from
1/2" to 1 1/4". New and used.
\$65.00 value. **Priced at only \$9.95**

SET 5 Different size H. S. Morse Taper
Shank Chucking Reamers from 1" to
2 3/4". New and used.
Priced at only \$11.95

HIGH SPEED HAND TAPS

Slightly used		Excellent Condition	
SIZE	PRICE EA.	SIZE	PRICE EA.
8-36 (new)	\$.35	5/8-NF	\$.66
1/4-NC or NF	.26	3/4-NF	.80
5/16-NC or NF	.29	1-NF	1.25
3/8-NC or NF	.33	1/8 pipe	.35
7/16-NC or NF	.39	3/8 pipe	.50
1/2-NC or NF	.47	1/2 pipe	.90
9/16-NC	.60	3/4 pipe	1.25

NEW SEMI-

HIGH SPEED

COMBINATION DRILLS AND COUNTERSINKS

60° Angle of Countersink

SIZE	DRILL SIZE	BODY	EACH
C2	1/16	13/64	\$0.49
E1	3/32	3/10	.49
F1	5/32	7/16	.69
F2	3/16	7/16	.69

5% discount for purchase of 1 doz. of any
size or mixture of above.

NEW CARBIDE TIP MASONRY DRILLS

Carbide tip goes
through any mason-
ry. Set of 5 bits
containing one 7/32"; three 1/4" and one
5/16", all five, \$10 Value,
\$2.49
only.....

4 SLITTING SAWS with MANDREL

SET 4 differ-
ent size
H.S. Slit-
ting Saws, 2 3/4"
dia. by 1" arbor.
Thickness from .040
to .071. Cuts wood, alu-
minum, brass, steel, etc. Plus special man-
drel which enables use of saws in 1/4" or 1/2"
electric drill. New and used. Added FREE
of charge, two 1/2" arbor grinding wheels
which will fit above mandrel. All **\$3.49**
7 of above items, only.....

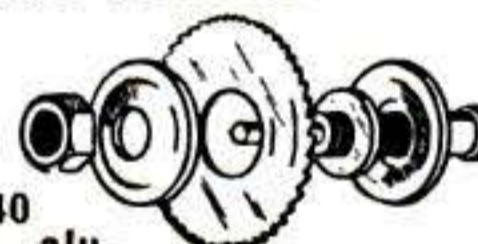

7 selected, sharp H. S. Slitting Saws as
above to use on your own mandrel or mill-
ing machine. New and used. A **\$4.95**
bargain at.....

Money-Back Guarantee—All Mdse. Mixture of New and Reconditioned Tools Unless
Specified Brand New—All Orders (Except Those Specified F.O.B. Tulsa) Are Shipped
Post Paid, saving you up to 25% on total delivered cost.

Write for Free Cat-
alog Describing
Thousands of Bar-
gainCuttingTools.

T & T TOOL 221 W. SECOND
TULSA, OKLA.

BARGAIN TOOL & SHOP MIXES!—PPD.

FILE MIX—BRAND NEW: Set of 12 dif-
ferent files, lengths 6, 8, 10, 12 in. Half
rounds, bastards, knife, mills, etc. First
line Nichols, Heller and other **\$3.49**
brands.....

SPRING MIX: 300 new springs, compres-
sion, tension and torsion types up
to 6" in length, only..... **\$1.79**

HAND REAMER MIX: 8 different size
hand reamers up to 5/8" including 3 taper
pin reamers. Majority of reamers **\$3.69**
in new condition.....

MILLING CUTTER MIX: Assortment of 4
various size H. S. milling cutters, **\$3.98**
all with 1" arbors; up to 3" dia. only

GRINDING WHEEL MIX: 30 grinding
wheels with 1/4" arbors, up to 3" in
dia., plus mandrel, only..... **\$3.29**

COUNTER BORE MIX: 4 H. S. **\$4.49**
eclipse type, sizes up to 1 1/4", only

NEW ROTARY FILE MIX: 7 different size
H. S. files, 1/4" shanks, New cost
as high as \$2.00 ea. Only..... **\$4.49**

VEEDER ROOT COUNTERS

3 Digit clockwise ro-
tation type **\$1.49**
(New).....
4 Digit clockwise ro-
tation type **\$1.89**
(New).....
5 Digit clockwise
rotation type
(Recon-
ditioned) **\$2.89**

5 Digit ratchet type
(Reconditioned) **\$2.49**

5 Digit clockwise rotation type with key
reset, complete with key, counts
in fives. (Reconditioned)..... **\$2.75**

5 Digit ratchet type, with key reset com-
plete with key, counts in singles. New cost
about \$17.00 when available. **\$3.49**
(Reconditioned) Only.....
All counters guaranteed against
mechanical defects

90° HEAVY DUTY GEAR BOX

Ball-bearing throughout
with 1/2" drive spline. 1:
1 gear ratio which
can be changed by dif-
ferent size pulleys or
gears. Wt. 5 1/2 lbs. Length
11"; beveled gears. Excel-
lent for hot rods, power mowers,
etc. Only..... **\$5.95**

10 TO 1 GEAR BOX: throw-out type clutch,
ball-bearing throughout, 1/2" drive spline,
3 1/4" output gear, rated up to
6 H.P. **\$6.49**

INDUSTRIAL QUALITY AT LOW COST **SHOP ACCESSORIES** **FULLY GUARANTEED**

Circular Saw Blades for 1/2-5/8-3/4" Arbors
MADE FROM CHROME-NICKEL MOLYBDENUM STEEL

FLAT GROUND		HOLLOW GROUND	
RIP • CROSSCUT • REGULAR OR NOVELTY COMBINATION		MITER OR PLANER BLADES FOR SMOOTHER CUTTING	
6" dia. \$1.88	8" dia. \$2.39	6" dia. \$2.75	8" dia. \$3.85
7" dia. \$2.18	10" dia. \$3.18	7" dia. \$3.19	10" dia. \$4.80

SHAPER HEADS FOR YOUR TABLE SAW
1/2-5/8-3/4" ARBOR
Only **\$4.50**

6 IN. DADO HEADS
CHROME-NICKEL-MOLY STEEL
1/2-5/8-3/4" ARBOR
Cuts 1/8 to 13/16" in steps of 1/16" Only **\$9.95**

8 IN. SANDING DISCS FOR YOUR TABLE SAW
1/2-5/8-3/4" ARBOR
Includes 1 coarse, 1 fine on each side
Only **\$4.95**

MOULDING CUTTERS
Only \$3.85 per set
CHOICE OF 38 PATTERNS

Extra Sandpaper 5 grits 80¢
Sanding Disc Cement 40¢

SEND CHECK OR M. O. All prices prepaid—WRITE FOR FREE CATALOG S-1

JAXON COMPANY • 369 ELLICOTT ST. • BUFFALO 3, N. Y.

USE KESTER METAL MENDER (GENUINE TIN LEAD SOLDER)

For all Metal Repairs

FREE: "Soldering Simplified." 16 page illustrated booklet. Get your copy now.



Kester Solder Company
4254 Wrightwood Ave.
Chicago 39, Illinois

FREE BOOK!

YOU, TOO, CAN START A \$40 A DAY BUSINESS IN YOUR SPARE TIME!

LIFE-TIME SECURITY WITH YOUR OWN BUSINESS

Andy Phillips says, "My BELSAW CIRCULAR SAW SHOP gives me BIG PROFITS at LOW expense... I can run 35 to 40 saws in an 8-hour day... That makes me \$40 cash."

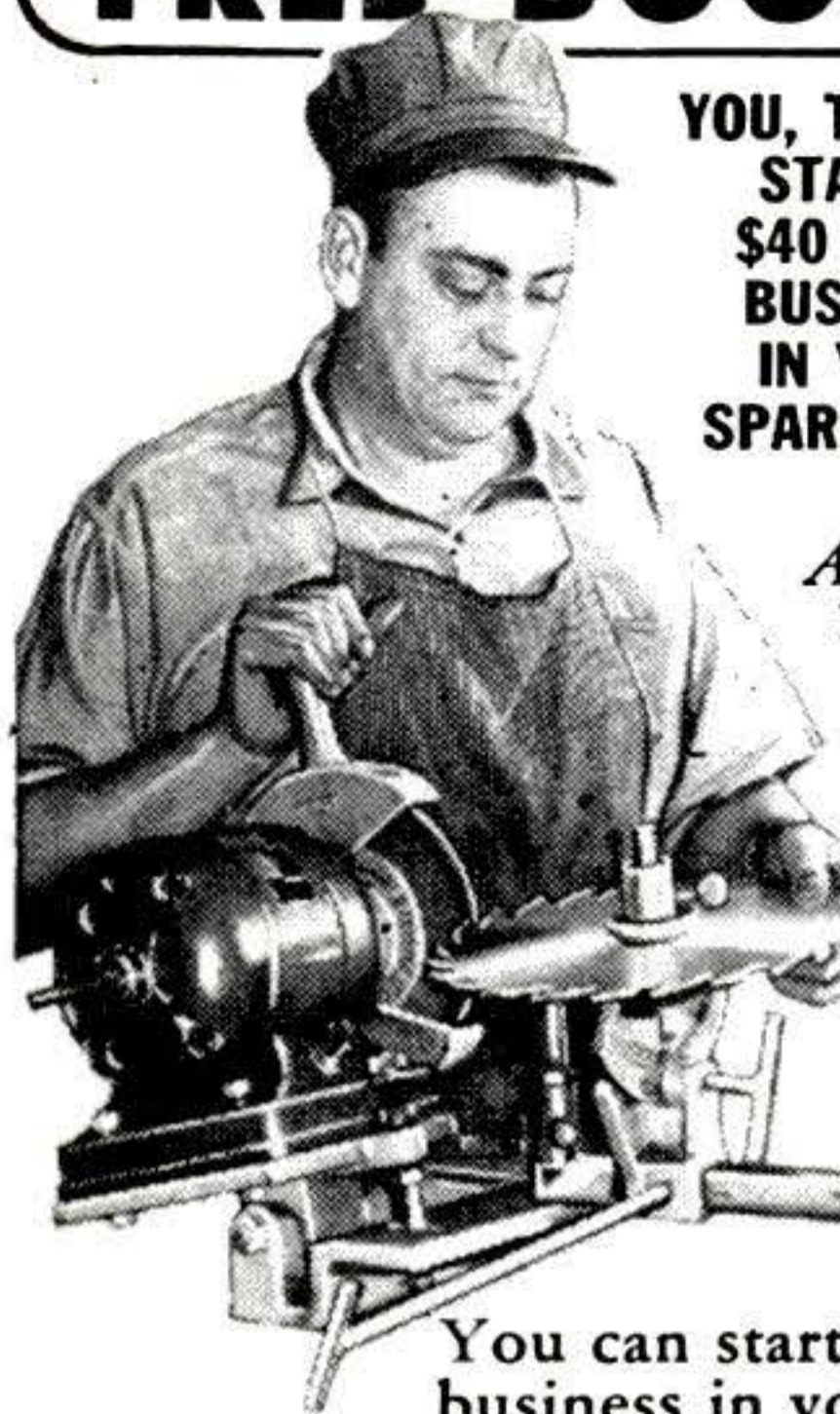

BELSAW

You can start this REPEAT CASH business in your own home or garage, while you are working at your regular job. Easy to operate, no experience needed. "Pays for itself from just 65 saw jobs." — Harvey Jensen.

For as little as \$15 down payment, you can get your BELSAW CIRCULAR SAW SHOP rushed to you.

You can make \$4 to \$5 an hour in your SPARE TIME sharpening and setting CIRCULAR SAWS for builders, lumber yards, factories... No Extra Equipment needed, no canvassing... send postcard for your Free Copy of "Life Time Security" today.

BELSAW MACHINERY CO

4404 Field Building

Kansas City 2, Mo.

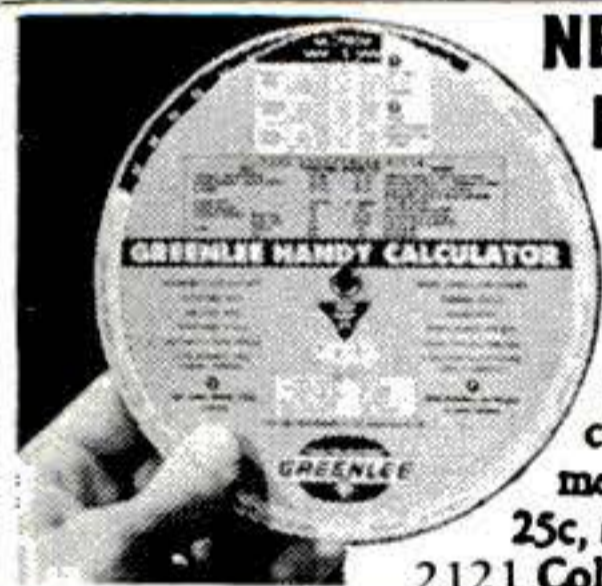

NEW, IMPROVED CALCULATOR FOR WOODWORKERS only 25c

Instantly gives information on lumber, nails, concrete mixes, painting materials, etc. Convenient, simple to read. Just set dial for nail specifications, to convert linear to board feet, find bit sizes for screws, compare characteristics of woods. 6" diameter heavily varnished cardboard. Send 25c, no stamps, please to Greenlee Tool Co., 2121 Columbia Avenue, Rockford, Illinois.

SAVE \$\$\$\$ DOING JOBS NO OTHER TOOL CAN DO!

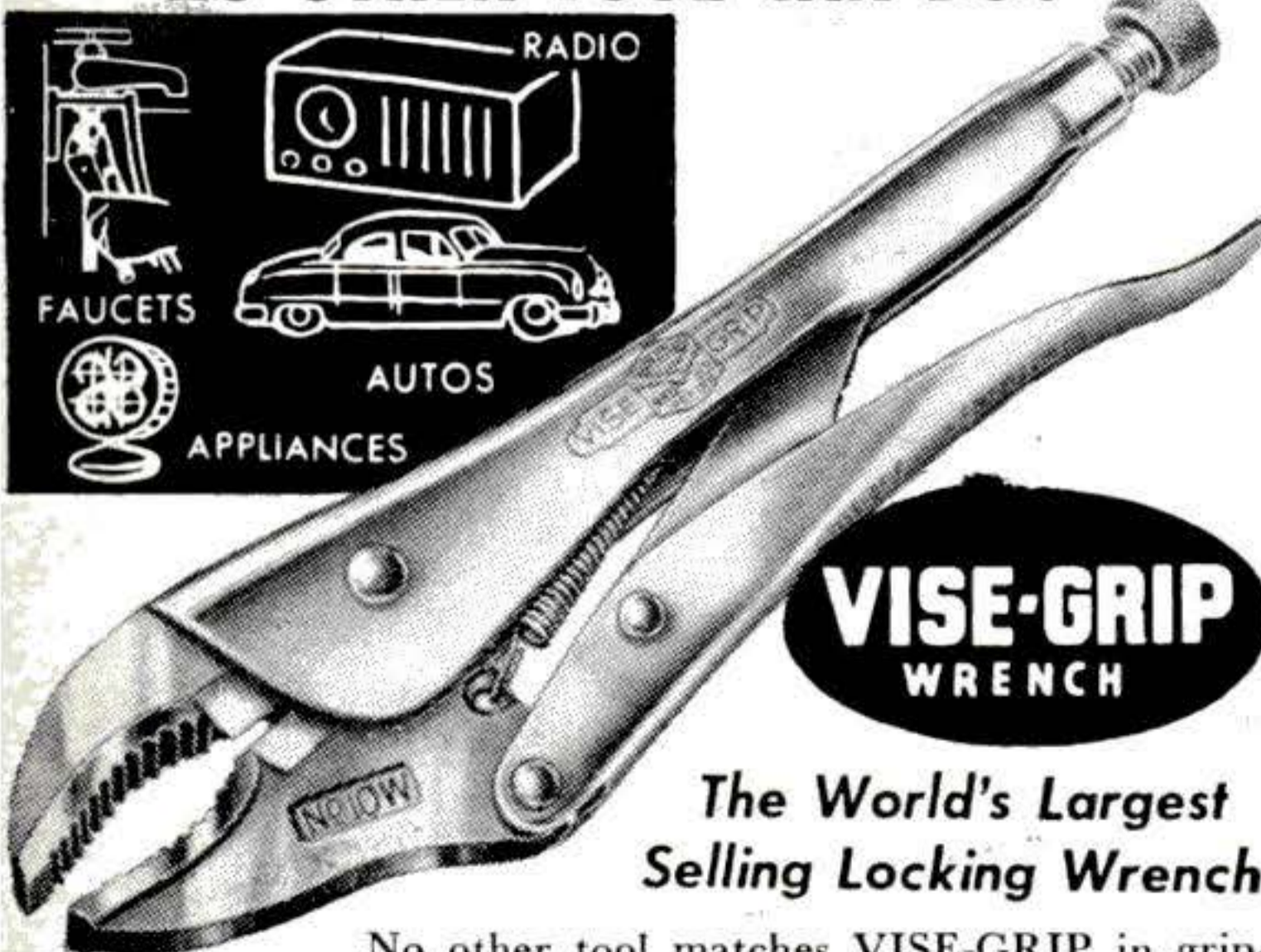
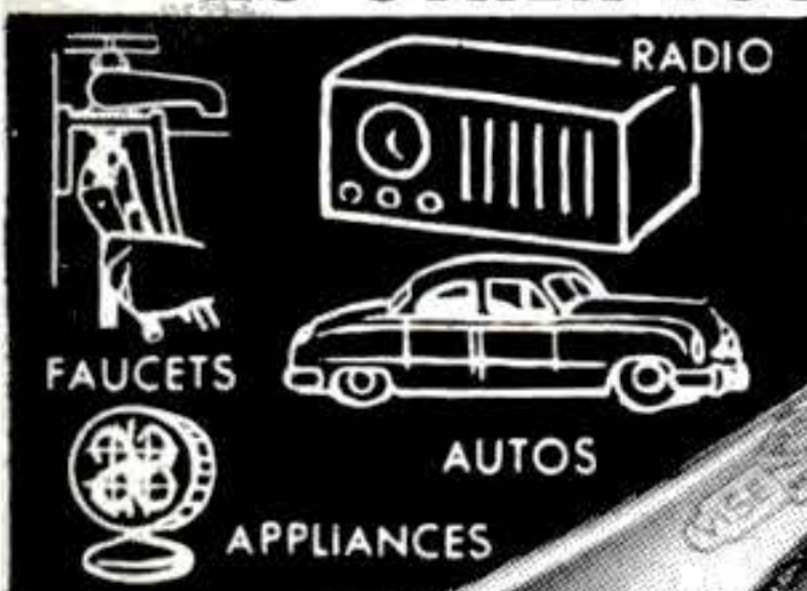

VISE-GRIP WRENCH

The World's Largest Selling Locking Wrench

LOW AS \$1.85

No other tool matches VISE-GRIP in gripping power! LOCKS with terrific non-slip grip. Makes the hard part of every job easy. Quickly turns battered nuts, screws and broken bolts. Cuts heaviest wire and bolts. Order From Your Dealer.

PETERSEN MFG. CO., Dept. M-1, DeWitt, Nebr.

GET 150 MILES PER GALLON

ENGINEERS HAVE PROVEN THIS POSSIBLE

The Electronic Spark Intensifier is only one of many ways you can gain "peak" performance. The manufacturer guarantees the following results or it costs you nothing!

- ✓ Quick Starts On Cold Mornings
- ✓ More Power ✓ Better Mileage

Easily installed in the center hole of the distributor cap of all cars, trucks and tractors, the intensifier boosts the high voltage passing through the distributor... giving a "hotter spark." This permits a wider spark gap which reduces misfiring and consequent ring and cylinder wear. A built in resistor protects plugs and other ignition points. FREE TRIAL, send \$2.00 cash, check or money order... if not fully satisfied, return for full refund.



ELECTRONIC DEVELOPMENT CO.
Dept. PS-1, Box 17716 Los Angeles 34, Calif.

ALNICO MAGNETS LIFT 175-lb.

AMAZING PERMANENT MAGNETS—WILL NOT WEAKEN! NON-ELECTRIC. Retrieve guns, tackle, tools and other steel items from lake, river, plating tanks, drains or other hard-to-reach spots. Recover drills, taps, etc. from floor sweepings. Clear alley of harmful tacks, nails. Many other uses listed. Pays for itself quickly. GUARANTEED: Try any magnet one week. Money refunded if you are not well-pleased. Cat. No. 675 (Has a pull of 175 lbs. on a flat steel block) \$10.50 Cat. No. 650 (150 lb. pull) \$8.50. Cat. No. 550 (50 lb. pull) \$4.00 Cat. No. 530 (30 lb. pull) \$3.00. Cat. No. 30—Hobbyist assortment of six medium magnets... \$1.50 Send M. O. or check. We pay postage. MIAMI MAGNET CO.

3240 N.W. 27th Ave., Aviation Bldg. No. 43, Miami, Florida

Amazing Midget Wrist Radio

\$2.98



Enjoy music, sports, programs with your own private, portable Wrist Radio! Use indoors or outdoors! Brings in local stations up to 50 miles! Worn like wrist watch, yet receives regular radio stations. Has super-sensitive crystal diode (worth \$1.95 alone!) & needs NO BATTERIES! NO TUBES! NO ELECTRICAL PLUG-INS! Lasts for years with NO EXPENSE! Built-in earphone. Complete with 2 clips. Just connect & set is ready for use. About 2 1/2-in. diameter, colorful plastic case, adjustable im. leather band. Only available at this low price while war-surplus diodes last so order now!

Complete Postpaid (2 for \$4.98) EACH COMPLETE POSTPAID ONLY..... \$2.98
JOHNSON SMITH & CO., Dept. 469, Detroit 7, Michigan

STANDARD GARDEN AND SMALL FARM TRACTORS

Powerful Gas Tractors for Small Farms, Gardeners, Florists, Poultrymen, Fruit Growers, Suburbanites.
1 & 2 Cylinders
High Wheels. Rubber or Steel Tires. Walk or Ride.

Easy Terms — Free Catalog

STANDARD ENGINE CO.
MINNEAPOLIS, MINN.
4041 Como Avenue



NEW YORK, N. Y.
681 West 26th Street

DRILL PRESS OWNERS!

HERE'S 1 TOOL WITH 5 DISTINCT USES



THE BARRON MULTI-PURPOSE ROTARY WOOD PLANER

PLANES & SURFACES • PANELS & BEADS
ROUTS & GROOVES • RABBETS • TENONS **\$7.50** COMPLETE

Finest precision performance—certainty of skilled workmanship—time-saving, money saving short cuts—yours with world famous Barron Drill Press Tools. Fifteen important operations—all available on any standard drill press—with Barron Accessories. Equip your shop with these versatile exclusively designed tools—and save up to \$500. 200,000 Barron owners have bought on our liberal 10 day full money back guarantee. Order, or write for catalog.

BARRON TOOL CO. INC.
206 Architects Bldg., Detroit 1, Mich.

FREE Workshop Guide & Catalog

WELLWORTH BARGAINS—ALL NEW EQUIPMENT



Wellworth AIR COMPRESSOR

For Farm and Home Workshop
Compressor has 2" bore, 1 3/4" stroke, 2.8 cfm up to 150 lb. pressure. Motor required: 1/4 h.p. at 100 lbs.; 1/3 h.p. at 125 lbs.; 1/2 h.p. at 150 lbs. or equivalent gas engine. V-belt drive, intake muffler and cleaner, bronze bearings, splash lubrication. Wt. 16 lbs. Replacement parts always avail- \$20.50

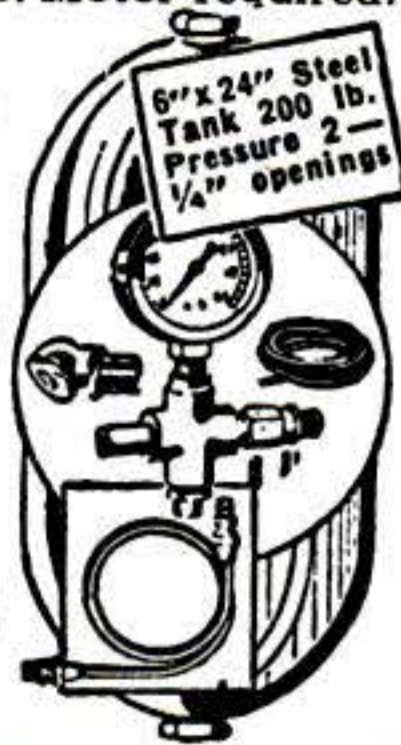

COMPLETE OUTFIT. Compressor, pressure tank, air gauge, air chuck, 20 ft. hose, pop valve, copper tubing with 4 brass flared fittings for connecting compressor to tank, 4-way cross and 3 nipples. **COMPLETE OUTFIT**, wt. 30 lbs. **\$32.45**
Equipment less compressor. . . . **\$12.45**
Tank only, \$6.25

Wellworth COMPRESSOR BUY



Model W3
2 1/2" x 2". 2.55 to 4.80 c.f.m. up to 150 lb. pressure. Operates with 1/3-1/2 3/4-HP Motor. **\$27.95**
Special Price.
Shipping wt. 24 lbs.

1 YEAR GUARANTEE

FEATURES

2 compression and one oil ring, aluminum alloy connecting rod. Stainless steel valves with brass seats and retainers. Cool-flo cylinder head, spray mist lubrication to every moving part. 10 1/4" V groove fly wheel for 5/8" B section belt.



Model W7
2 cylinder 2 1/2" x 2". 5.10 to 8.50 c.f.m. up to 150 lb. pressure. Operates with 1/2 -3/4-1-1 1/2 HP motor. **Special \$54.50**
Price.
Shipping wt. 45 lbs.

"WELLWORTH" BLOWER BARGAIN



BRAND NEW. Quiet operating. Double wheel inlet, double width blower. For heating, ventilating, cooling, air washing, exhausting and forced draft. **DIMENSIONS:** 10" wheel; outlet 13 1/8" x 11 3/8"; inlet 8 3/4". Height 19". Width 18". Depth 16 1/2". C.F.M. 1/4" S.P. 1600; outlet vel. 1575. Wt. 45 lbs.
BLOWER LESS MOTOR AND DRIVE **\$27.50**
With belt and variable speed pulleys, \$2.50

Same Blower, complete with 1/4 HP Motor. . . . **\$47.50**

140 CFM "WELLWORTH" BLOWER

5 1/8"x4" mounting flange with 2 1/2" square discharge, 3 1/2" dia. blower wheel powered by direct-connected 1/15 H.P., 110 V., 60 C., A.C. motor with conduit box and 20" leads, 7 1/2" wide less flange by 16 1/2" H. x 6 3/4" D. Shpg. wt. 6 lbs. **\$16.20**
50 CFM BLOWER, 2 1/2" discharge **\$10.95**

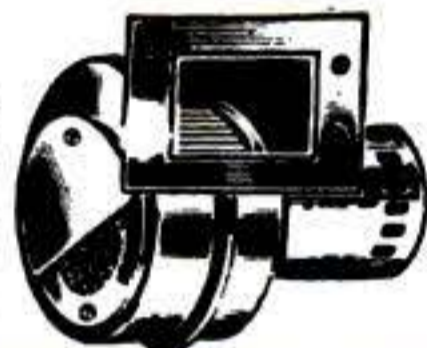

WELLWORTH V-BELT CLUTCH



BRAND NEW Takes starting load off engines or motors. When speed is reached, a flip of handle shifts clutch from idling to driving position. Handles "A" belts, 2.35" pitch diameter, 5/8" bore. Ideal for use with lawn mowers, garden tractors, home workshop motors, etc. 3 1/4" long. Safe, easy to mount, sealed bronze bearings, positive action. Shpg. wt. 3 lbs. **\$7.50**
BUSHING FOR 1/2" SHAFT 15c

PRICES F.O.B. CHICAGO. MONEY BACK GUARANTEE. SEND CHECK OR MONEY ORDER TODAY. PROMPT SHIPMENT. WRITE FOR CATALOG. SEND 10c FOR POSTAGE.

2000-2500 WATT LIGHT PLANT

Heavy Duty Windings

110 v., 60 cy., A.C., takes starting overload up to 5000 watts. Floating Base for Automatic Belt Adjusting, 2-Groove Engine Pulleys, V-Belts, Bolts, etc. 5 H.P. Wisconsin or Briggs & Stratton Model 14 Engine. Voltmeter, 2 plug-in receptacles. Portable Tubular Steel Skid Type Carrier. Dim. L 34 3/8" x W 17" x H 20". Wt. 180 lbs. **\$299.50**

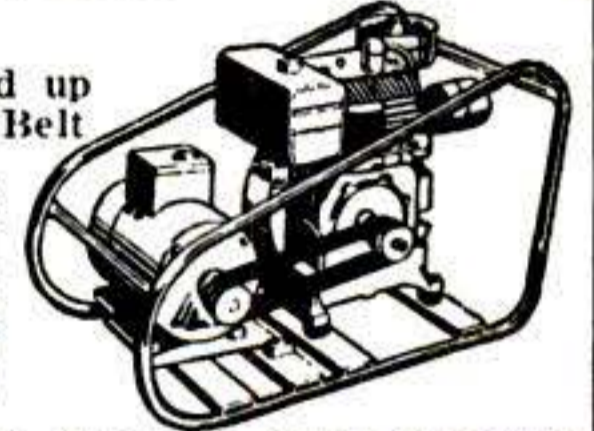

Generator only with voltmeter, 2 plug-in receptacles, Shpg. Wt. 75 lbs. **\$169.50**
500 watt Generator, wt. 55 lbs. **\$99.50**
5000 to 6000 watts Generator, 110-220 V., wt. 225 lbs. **\$325.00**



LELAND GENERATORS

2500 to 3000 watts, 110 v. 60 cy. single phase 1800 r.p.m., self excited. Fungus treated for long life. 1951 model. Brand new, in original factory crate. Shipp. wt. 135 lbs. List \$375. **SPECIAL \$237.50**
PRICE

AIR TANK AND ACCESSORIES

Brand New steel 6"x24", 400 lb. test. Ideal wherever compressed air is needed. Equipped with 500 lb. combination air gauge and inflation valve with core for retaining pressure in tank; tire chuck, 3 ft. high test air hose. **Ship. Wt. 12 lbs. \$7.95**
Complete outfit



WELLWORTH TRADING CO.

1832 S. WABASH AVE. DEPT. B-152 CHICAGO 16, ILL.

GET READY NOW FOR NEXT SUMMER'S DRY SPELLS

Sturdily Made—Hundreds of satisfied customers. Purchased and used by U.S. Dept. of Agriculture, U.S. Dept. of Forestry, U.S. Navy and many foreign countries. Fully Guaranteed. **LOW FACTORY PRICE, \$385.00;** less Motor F.O.B. Factory. Price includes drill, bailer and 100' cable, 200 ft. of additional length available at extra cost.

Drill your own wells for that needed water—as many as you need—outside—in the cellar—in the barn. The new improved CONSOL Driller—1951 Model—is equipped with a special replaceable Drill Head. It will drill through many feet of solid rock without resharpening. Simple to operate, easy to set up. Do the work yourself at small cost.

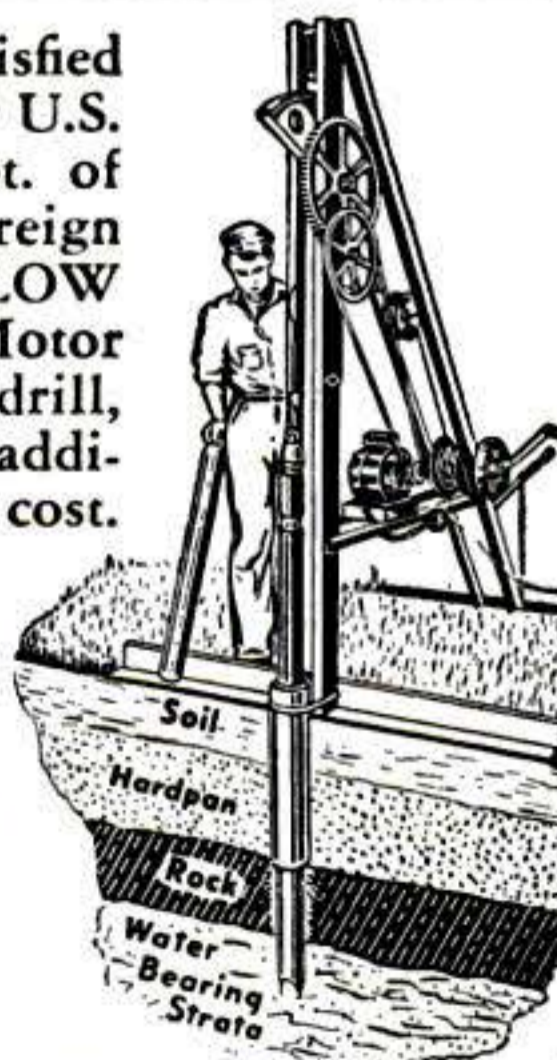

A HEAVY DUTY MODEL for 6" casings also available at \$1295, F.O.B. Factory, equipped with Gasoline Engine. Write for free information and booklet, Dept. PS



CONSOLIDATED INDUSTRIES
West Cheshire, Conn.

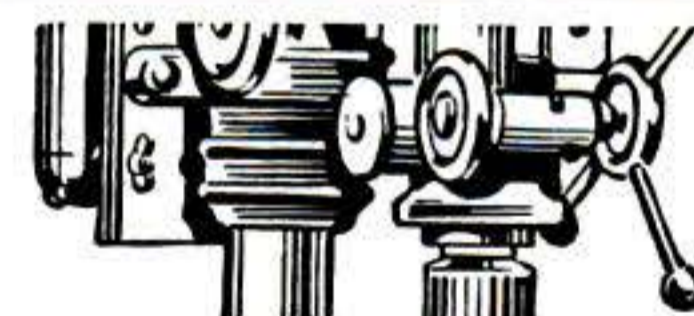

Handy Flexible SHAFT

With 1/8 Inch Adjustable Chuck

ONLY \$3.95

Converts any motor, drill press, electric drill, electric fan (10 inch or larger) into a handy rotary tool.

Attach ROTA-SHAFT in a jiffy. Use for grinding, polishing, sharpening, cleaning, engraving, making tools, carving on metal, plastic, wood, leather, glass. **Handles tools from zero to 1/8 inch diameter.** 40-inch overall length. Complete with buff and sanding disc ready to use in a drill press chuck. **ORDER TODAY!**

OLD FAN MOTOR



VACUUM CLEANER MOTOR



SEND NO MONEY! Mail your order, only \$3.95 plus postage on delivery. Try 10 days—if not delighted return for money back. **For use on motor—35c extra for Special Coupling.** Give exact size of motor shaft diameter.

STRADER PRODUCTS CO., Dept. E-102
259 Strader Ave. Cincinnati 26, Ohio



Make YOUR ELECTRIC DRILL A MULTI PURPOSE TOOL

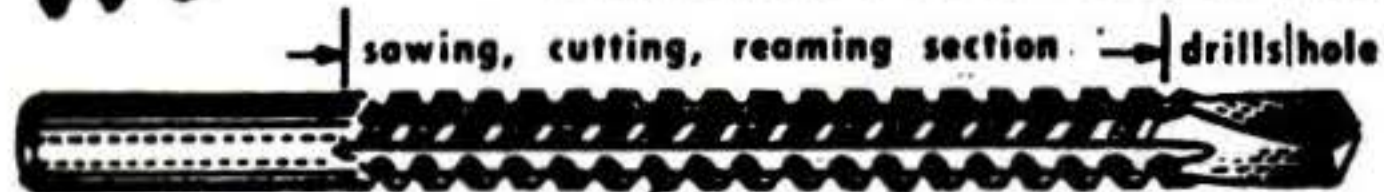

DRILL, SAW, REAM . . .

metal, pipe, wood, plastic, Transite, etc., with the all-purpose International Rotary Cope-Saw Drill-bit shown above. Use with any electric drill, slow drill press, lathe or milling machine. Drills own starting hole—upper part of bit is used to cut, saw or ream circles, ovals, squares or scrolls. Easy to operate. Ideal for carpenters, mechanics, electricians, plumbers, hobbyists, many others. Abrasive resistant, high speed steel. Flutes ground from solid. Will withstand severe continuous use without breaking. Resharpener at no charge. Takes place of up to \$50 in tools. 1/4" diameter, 2" cutting sections, total length 3 1/2". Also available bits specially designed for wood or metal and in 2 3/8" and 1 3/4" lengths. Write for details. Specify all-purpose bit.



Drill Bit
\$3.95
Post Paid

NOW YOU CAN PLANE . . .

with your 1/4" electric drill and the International Drill-Plane Converter. For fast, accurate planing, beveling, ripping. Rips up to 1 1/4" strip, planes 1/4" at one stroke, 15 times faster than any hand plane. Rips boards up to 1 3/4" thick. Nothing like it exists. Too many uses to mention. 2 planing blades made of finest available High Speed steel included. Blades are 1/4" diameter, 2" cutting surface. Electric Drill not included. Regular electric planers cost up to \$150.00.

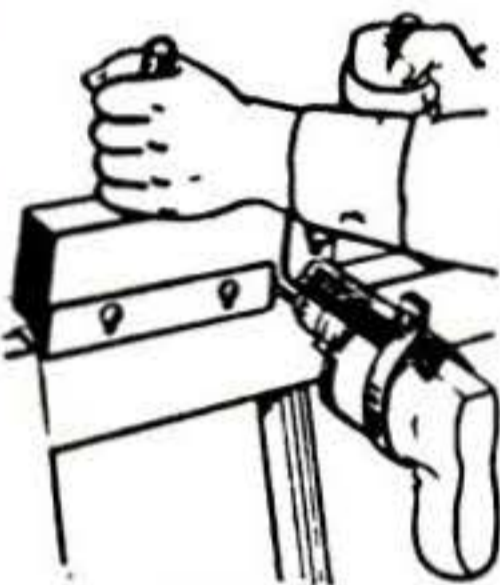

Drill Plane Converter

Send cash, check or M.O.
Money back guarantee
Shipped same day
Dealer inquiries invited

Plane Converter
\$14.95
Completely Assembled

Manufactured & Distributed by:

INTERNATIONAL TWIST DRILL CORP.
618 Wyandotte • Room 697 • Kansas City 6, Mo.

IT'S EASY TO MAKE \$3 AN HOUR AND MORE SHARPENING LAWN MOWERS

IN YOUR SPARE TIME

J. S. of Michigan writes, "I figure my profits for last season at over \$1,000.00 part time." C. R. of Ohio tried the Universal on a part-time basis and now gives it full time. He says "I have taken in, last season, more than \$3,500.00."

ONLY ON THE UNIVERSAL LAWN MOWER GRINDER
can the inside face and edge of the stationary blade, and all reel blades, be ground to proper clearance **ALL IN ONE SET-UP**

WITHOUT REMOVING ANY BLADE FROM THE MOWER
Write for details. Learn how to make real big money.
ROGERS MFG. CO., DEPT. P-12, LINDSEY, OHIO

SAVE 85% in WAR SURPLUS

FAMOUS GSAP 16MM CAMERA

That famous "gun camera" used by the Navy & USAF. Now adapted to hand use for making professional or amateur movies. Takes pictures in B&W or full Color. Has 1-3/8" lens, built-in exposure guide and shade. Adjustable for 3 SHUTTER SPEEDS - 16, 32 & 64 frames per second. Uses regular Eastman magazines (50 ft). Requires no winding - no film threading. Comes complete with "ZOOM" Range-finder & Battery Box. Operates on 24 volt current supplied ordinary flashlight batteries. **READY TO USE!** (Needs only film & batteries).



44.95

150 POWER ALL PURPOSE COMBINATION MICROSCOPE

A TRIPLE PURPOSE INSTRUMENT. Small and compact yet Powerful! Has a tilting stand with mirror reflector and slide stage for USE IN THE LABORATORY. Will magnify surface views up to 150 POWER when separated from stand to USE AS A POCKET MICROSCOPE. Has an attachment to hold slide directly in the instrument for using as FIELD MICROSCOPE. COMPLETE WITH SLIDES & LEATHER CASE.

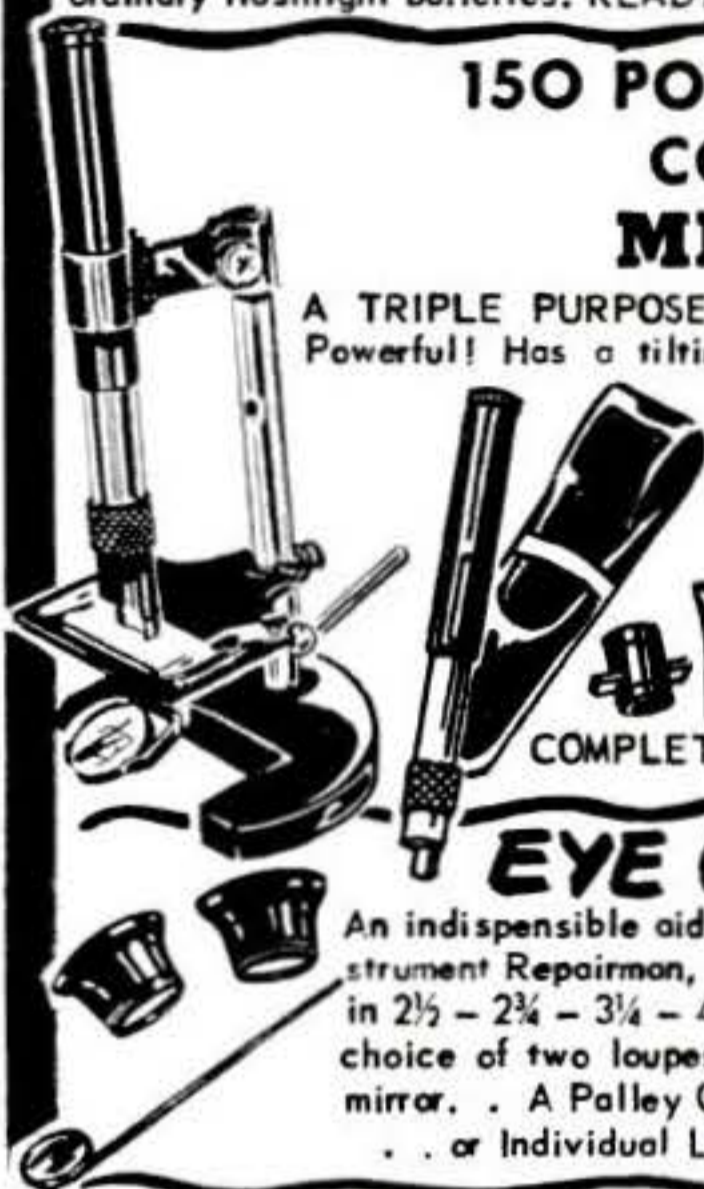

7.95

EYE LOUPE SET

An indispensable aid to the Jeweler, Scientist, Watchmaker, Instrument Repairman, Lab Technician, Machinist, etc. Available in 2 1/2 - 2 3/4 - 3 1/4 - 4 & 5 power magnification. Your choice of two loupes (any power) & 1 inspection mirror. A Palley Combination Bargain - ONLY . . . or Individual Loupes (any power) - 99c each.

2.29

8 POWER COATED LENS TELESCOPE

A very handy instrument for spotting distant objects. Small as a pocket pen yet has full 8 POWER magnification. Has expertly ground, precision polished lenses. Body is made of fine grade, polished metal with pocket clip. Easy focusing. 8 1/4" expansion. A \$10.00 Value.

1000 VALUE
\$4.95



SWISS PATTERNED NEEDLE FILES

The ideal set for the model maker, technician, repairman, etc. Made of the finest quality, Sheffield Steel, specially hardened and accurately machined for precision filing. Set of 12 ass't shapes - A \$5.00 Value -

2.95



LUND TRAILWAY SNOW SHOES

Genuine LUND Snow Shoes. Size of frame is 10" by 52". The one-piece, special hardwood frames are laced with good quality, water-proof, thongs. Designed for faster, easier travel.

22.50 VALUE
14.95

7 Ft. G.I. SKIS with metal edges. \$13.50

SKI POLES

Natural cane or laminated steel pole with leather laced snow ring. Pole is metal tipped. Has wrist straps. Length is 4 feet. Ideal for use with skis or snow shoes. A Palley Value at

Only 3.95

NEW! GENUINE ARMY SKI PATROL PARKAS

Made of heavy White Duck. Wind and water resistant. Slip-over type with draw strings on each cuff and around waist and hood. Neck has four tie-straps for adjustment. Body is finger-tip length with 2 large outer pockets. Ideal weather protection for the outdoor sportsman, hunter, farmer, rancher, etc. A BUY!

2.49



NEW GOGGLES

Soft, molded rubber frames, chamois lined. Comes with 8 lenses, 2 clear, 2 amber and 4 Green. All lenses are easily and quickly inter-changeable. COMPLETE

3.95



PALLEY SUPPLY CO
DEPT. P-51, 6321 SAN FERNANDO RD.
GLENDALE 1, CALIF.

SEE AD ON OPPOSITE PAGE FOR TERMS!

FOAM RUBBER

in Slabs, Sheet stock & molded, preformed Cushions, Mattresses & Pads. Use it for upholstery, beds; pillows, nooks, chairs, sofas, patio & yard furniture, auto seats, boat deck pads, etc. Priced FAR BELOW current market.

CORED STOCK—Smooth one side, "cored" on other side to give maximum resilience & reduce weight. Ideal for chairs, cots, beds, bunks.

thick -	per sq. ft.	thick -	per sq. ft.
1"80	3"	\$1.70
1½"	1.10	4"	3.00
2"	1.50	4½"	3.14

SLAB STOCK—Smooth both sides. A solid but spongy material. Used for pads or shock-absorbing layer pads.

Thick	Per sq. ft.
1/4"	\$.25
1/2"50
3/8"38
3/4"75
1"	1.00

PALLEY'S WILL CUT the Slab or Cored Sheet Stock to your needs. However all pieces must be rectangular or square in shape, at least 1 sq. ft. or larger.



TOPPER PADS	
25" x 60" x 1 1/4"	\$7.95
25" x 60" x 1 1/2"	8.95
25" x 65" x 2"	9.95



SEAT PADS	
22" x 18" x 3"	\$5.00
22" x 20" x 3 1/2"	\$5.00
35" x 18" x 4"	\$10.75
20" x 20" x 5"	\$6.00

17 Power Telescope

A fine quality, IMPORTED instrument. Gives a bright, clear image with a wide field of view. An ideal telescope for all-around use. ONLY **7.95**

20 inch TANK TELESCOPES
3 Power...\$4.95—20 Power...\$8.95



EXACTOR HYDRAULIC REMOTE CONTROL

MASTER & SLAVE Consists of two units. Designed to operate controls on boats, machinery, engines, motors, etc. without need for rods, cables, pulleys, etc. When connected with 1/4" tubing & filled with oil they act as a precision, remote controller. When Master handle is moved, Slave arm responds in exact motion. Range is 0 to 90 degrees. Combination Master & Slave for **42.50**
MASTER only - For an extra control... **21.25**

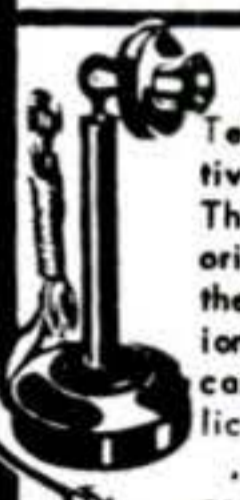

MICROPHONE

Telephone type, highly sensitive with excellent, Clear tone. This was the Signal Corps favorite. An ideal instrument for the radio "ham" and professional recording studio, broadcasting, home recording, public address, etc. Complete with cord & plug... **3.29**
A SENSATIONAL BUY!

NEW! 1952 CATALOG

OVER 230 PAGES COMPLETELY ILLUSTRATED Showing Thousands of items in NEW and WAR SURPLUS! Some at SAVINGS up to 85%! Clothing, Household Items, Power and Hand Tools; Camping & Outdoor equip., Farm & Ranch supplies, Electrical and Pneumatic equip., & a huge stock of Hydraulic equip., including Cylinders, Valves, Pumps, Motors, Fittings, etc. Send only 50¢ for your copy TODAY!

SAVE UP TO 85% IN WAR SURPLUS

D.C. ARC WELDER

300 AMPS CONTINUOUS
350-400 AMPS. INTERMITTANT

For light or heavy duty work. Will easily handle welding up to 1/2" plate. Made to operate continuously, giving years of trouble free service. Built around that famous B-29(R-1) generator incorporating many features no other generator has. Unit includes pulley re-actor output controls. Hi-lo switches & rheostats. All assembled on heavy steel frame and easily adapted to mounting on jeep or tractor for portability & power supply. Can be run on 7 1/2 H.P. electric or 10 H.P. gas motor. Generator alone cost Gov't \$400!



STATIONARY OR PORTABLE

97.50 NOW ONLY

CHEMISTRY SET

Made for Chemical Warfare Division for testing, water, etc. A handy addition to the chemistry lab, or an exciting experiment for the amateur. Set includes test tubes, complete instructions, 15 different items. Packed in attractive lucite box with cover and dividers... **1.89**

NAVY Sealed Beam LAMP

U.S. NAVY portable search-spot light. Has pistol grip and aiming sight. Makes an ideal search, spot or emergency light for auto, boat, etc.

12V. light - 4" lens... **3.29**
24V. light - 4" lens... **3.79**
Set of 3 filters: red, green, amber (specify type lamp)... **99¢**



NAVIGATORS LAMP

A handy light for desk, work-bench, chart table, engine room, etc. Can be used on 6-12-24 & 110 Volt by changing bulb. 3 ft. shaft has 4 joints to adjust position... **3.29**



TACHOMETER

Operates on direct drive with a flex shaft from camshaft or at 2 to 1 reduction from crankshaft. Range is 0 to 4500 R.P.M. Ideal for planes, boats, autos, etc. **4.75**



HUNTING KNIVES

GENUINE G.I. EQUIPMENT. Has a 6 inch, polished Vanadium blade & Handle made of leather and fibre discs. Complete with tanned leather sheath. Only **1.98**



NYLON FISHLINE

STRONG - LIGHTWEIGHT - NYLON FISHING LINE. ROT-PROOF and WATERPROOF...

1500 ft.	10 lb.	\$1.59
1000 ft.	25 lb.	\$1.80
750 ft.	45 lb.	\$3.29
750 ft.	50 lb.	\$3.50
300 ft.	72 lb. Braided	\$3.79



HAND LINE

Rot-proof, weather resistant, hard linen line. Originally used as hand line in fishing for tuna, marlin, etc. Also has many uses around farm, factory, etc. NEW in 300 ft. lngths. **1.69**



NEW DRY LENSATIC COMPASS

Officer's type. A precision compass of unusual accuracy. Has prismatic, hair-line guide for sighting at distant objects & at same time reading the degree. Luminous dial for night, jewel mounted needle. Canvas carrying case for belt. NEW. **ONLY 3.95** (5.95 VALUE)



COMFO RESPIRATOR

Approved by U.S. Bureau of Mines for DUST & MIST. New, cushion face-piece fits comfortably & allows easy wearing of helmet & goggles. Extra large filtering area provides higher efficiency. Uses single filter for all types of dust. Easy vision, adjustable head strap. With 10 extra filters. NEW-VALVE TYPE - 29¢ ea. **1.79**

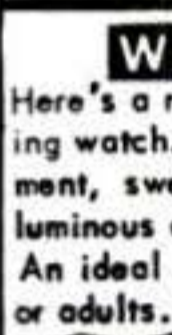

WATCHES

Here's a real shock absorbing watch. Has jewel movement, sweep second hand, luminous dial, chrome case. An ideal watch for children or adults. Fully guaranteed. **6.95**

17 JEWEL CHRONOGRAPH - One of the finest made anywhere. Sweep second hand, stop and re-set button. Measures airspeed, groundspeed, races, etc. Ideal watch for the sportsman. **26.95**

17 JEWEL AUTOMATIC A fine, self-winding watch for men. Winds itself as you wear it. Has genuine Incabloc (shock protected) movement. In choice of Silver White or Black face. Water-proof case with stainless steel back. Has full sweep second hand. Comes with genuine leather strap. Factory guaranteed for one year. (plus 10% Federal Tax) **26.95**

7 x 35 BINOCULARS

The Very POPULAR CENTER FOCUS Model with Coated, Achromatic Lenses. Combines higher resolving power with extreme image brightness and amazing clarity. An IDEAL GLASS FOR ALL AROUND USE DAY or NIGHT! Has Lightweight, Precision made, Aluminum housing. Field of view is approx., 375 feet at 1000 yds. Complete with Leather Carrying Case and Neck Straps. **47.95** (PLUS FED.TAX)

7 X 50 PRISM BINOCULARS Big, Powerful Lenses give maximum image brightness & needle-sharp vision. Individual eye focus, Wide field of view. With Leather Case and Straps. **33.95** (plus Fed. Tax)

SILK PARACHUTE, CAR COVER - 24 ft in diameter (approx. 50 sq. ft.) Enough to cover any car or small truck. Heavy, double stitched seams. **16.95**

FLYING SUIT or Blue Bunny SUIT For hunting, winter sports, skiing or "bundling". As coveralls, for cold outdoor or farm work. 100% woven wool with extra flannel inner lining for double warmth and utility. Wiring so fine, flexible, it does not interfere with movement. Can be used with or without heating or can be plugged into car, tractor or truck battery... **ONLY 4.95**

16 POCKET VEST The ideal jacket for the Rifleman or Hunter... Has 14 individual, outside pockets for shells, glasses & other accessories. 2 large (11" x 8") inner pockets, a leather holder for knife, gun or tool. Sturdy, yet lightweight with tie-straps at back for adjustable fit... **3.49**

Hunting & Field BOOTS Assures complete foot and shoe protection in the coldest weather. Specially designed to keep the feet warm and comfortable & the shoes dry. Has 9 inch leather boot top, rubber shoe & sole with felt inner sole. Reconditioned - in excellent condition. **3.95**
A PALLEY BUY NEW **4.95**

Navy WADING SUIT Adds real pleasure to surf & deep stream fishing. Made of rubberized canvas. Vulcanized seams. Has inner air pockets, to give buoyancy & balance in deep water. Finest quality, rubber gloves & 1/2 length rubber boots attached to sleeves and pants legs... **6.95**
SIZES: small; medium; large

ORDER FROM THIS AD. All sales final. Prices F.O.B. Glendale. Pay by M.O. or Check. P.O.'s accepted from D & B. Firms. 1/2 deposit with C.O.D.'s.

A.F. FLEECE LINED JACKET

GENUINE LEATHER Will keep you warm and comfortable in the roughest weather. Has fleece lining throughout... sleeves & body. Two, roomy, slash pockets & full zipper front closure. Really an ideal jacket for all Outdoorsmen... Hunters, Farmers, Mechanics, Ranchers. RE-CONDITIONED in WONDERFUL CONDITION. **14.95**

FLYING HELMET Fine grade leather - Chamois lined with chin cup and strap. Intermediate weight. **1.59**
NEW - ONLY

ALL NEW! Winter type with fleece or chamois lining. Has ear puffs and chin cup. Ideal for pilots, cycle-drivers and sportsmen **ONLY 1.95**

Aviators (AN-6530) Windproof & Dustproof GENUINE GOGGLES

Rubber or chamois covered frame. Clear or green GROUND LENSES are interchangeable. Adjustable nose bar. Ideal for flying, motorcycle riding, etc. **2.19**

GO-1 GOGGLE KIT NEW! U.S. NAVY Has soft sponge rubber frame. 4 Polaroid lenses, 2 green; 1 red; 1 clear. Perfect for racing, cycling, etc. **SPECIAL 89¢**

WATCHES Here's a real shock absorbing watch. Has jewel movement, sweep second hand, luminous dial, chrome case. An ideal watch for children or adults. Fully guaranteed. **6.95**

17 JEWEL CHRONOGRAPH - One of the finest made anywhere. Sweep second hand, stop and re-set button. Measures airspeed, groundspeed, races, etc. Ideal watch for the sportsman. **26.95**

17 JEWEL AUTOMATIC A fine, self-winding watch for men. Winds itself as you wear it. Has genuine Incabloc (shock protected) movement. In choice of Silver White or Black face. Water-proof case with stainless steel back. Has full sweep second hand. Comes with genuine leather strap. Factory guaranteed for one year. (plus 10% Federal Tax) **26.95**

7 x 35 BINOCULARS The Very POPULAR CENTER FOCUS Model with Coated, Achromatic Lenses. Combines higher resolving power with extreme image brightness and amazing clarity. An IDEAL GLASS FOR ALL AROUND USE DAY or NIGHT! Has Lightweight, Precision made, Aluminum housing. Field of view is approx., 375 feet at 1000 yds. Complete with Leather Carrying Case and Neck Straps. **47.95** (PLUS FED.TAX)

7 X 50 PRISM BINOCULARS Big, Powerful Lenses give maximum image brightness & needle-sharp vision. Individual eye focus, Wide field of view. With Leather Case and Straps. **33.95** (plus Fed. Tax)

SILK PARACHUTE, CAR COVER - 24 ft in diameter (approx. 50 sq. ft.) Enough to cover any car or small truck. Heavy, double stitched seams. **16.95**

FLYING SUIT or Blue Bunny SUIT For hunting, winter sports, skiing or "bundling". As coveralls, for cold outdoor or farm work. 100% woven wool with extra flannel inner lining for double warmth and utility. Wiring so fine, flexible, it does not interfere with movement. Can be used with or without heating or can be plugged into car, tractor or truck battery... **ONLY 4.95**

16 POCKET VEST The ideal jacket for the Rifleman or Hunter... Has 14 individual, outside pockets for shells, glasses & other accessories. 2 large (11" x 8") inner pockets, a leather holder for knife, gun or tool. Sturdy, yet lightweight with tie-straps at back for adjustable fit... **3.49**

Hunting & Field BOOTS Assures complete foot and shoe protection in the coldest weather. Specially designed to keep the feet warm and comfortable & the shoes dry. Has 9 inch leather boot top, rubber shoe & sole with felt inner sole. Reconditioned - in excellent condition. **3.95**
A PALLEY BUY NEW **4.95**

Navy WADING SUIT Adds real pleasure to surf & deep stream fishing. Made of rubberized canvas. Vulcanized seams. Has inner air pockets, to give buoyancy & balance in deep water. Finest quality, rubber gloves & 1/2 length rubber boots attached to sleeves and pants legs... **6.95**
SIZES: small; medium; large

ORDER FROM THIS AD. All sales final. Prices F.O.B. Glendale. Pay by M.O. or Check. P.O.'s accepted from D & B. Firms. 1/2 deposit with C.O.D.'s.

PALLEY SUPPLY CO. DEPT. PS-1 6321 SAN FERNANDO RD GLENDALE 1 CALIF.

Death Designed This Fire Truck

[Continued from page 84]

Auto accidents also have increased enormously since McGinley was a rookie. Today, he thinks, there are more cases than ever in which people are trapped inside smashed cars and must be cut out. Rescue No. 1 carries power saws and metal cutters for the job (the oxyacetylene tool might ignite the gasoline). A few years ago it took 45 minutes to make a rescue like this. Now, with proper tools and training, it can be done in 15 minutes.

The valuable experience of other East Orange officials contributed to the planning of Rescue No. 1. Mayor Charles H. Martens, now finishing 34 years at his job, was one. Dr. Francis Lucas, long-time fire commissioner and a scientist who could spot defective equipment as no one else in the department could, was another. The American-LaFrance-Foamite Corporation built the truck at a cost of \$35,940. Equipment cost thousands more.

Saving Lives Costs Money

"It was an expensive item," McGinley admits, "but it was worth every nickel. If I were chief, I'd give up any company for economy reasons rather than the one on the rescue truck."

Acting Chief George Rebhan of East Orange agrees. Rebhan, who keeps the records, doesn't know how many lives the truck saved in 1951, but he does know that nearly all of its oxygen patients recovered. "You can't measure those things in money," he says.

Saving lives is the first duty of the rescue squad; then comes the saving of property. The squad is so trained that in a minute it can stack furniture in the center of a room and throw tarpaulins over the stack. Rescue No. 1 carries 12 tarpaulins. "Water damage is almost nil," McGinley reports.

Radio Speeds Rescue Calls

When McGinley became fire chief in East Orange, 24 years ago, alarms traveled over open wires. Storms knocked down the wires. He still moves uneasily in his armchair by the fire when he thinks of sections of the town being cut off. Eventually, he got an underground alarm system, which is weatherproof. Rescue No. 1, furthermore, has two-way radio for communicating with headquarters, other fire trucks, chiefs' cars and the police. The radio is FM—because

FM is static-free. The department also plans a walkie-talkie for the big emergency truck soon.

But even with the best communications in the world, there are times when turning in the alarm depends on the slightest tricks of fate.

Not long ago the East Orange rescue squad was called out to see if a man was buried in ashes in a silo at a concrete-block works. He was. He had been working in the silo when a load of ashes was dumped into it. The rescue squad cut blocks out of the silo walls and, with hand shovels, dug into the ashes and tossed them out the holes they had made. They found the man, put a harness on him, and hauled him out over the top of the silo, which was some 35 feet high.

Payday Pays His Life

The man was uninjured. He had been able to breathe because ashes are porous, and they hadn't been heavy enough to hurt him. But he could not have continued to breathe much longer than the five or six hours he was buried. "This was a rescue-squad job absolutely," McGinley says. "They do things other firemen can't, because of their equipment." But there was that trick of fate.

The day was payday, and the man buried in the ashes was not missed until he failed to show up for his money. That started the search and led to the rescue. "But," McGinley reflects, "if it hadn't been payday. . ."

END

Bubble-Blowing Liquid Spots Puncture

WHEN a tube bath isn't available, you can spot punctures by brushing on some of the bubble-blowing liquid that children play with. The smallest pinhole will produce a bubble. The liquid is good for testing a new patch, too.—*R. Janovsky, St. Louis.*

Does Rubber Burn Off Tires?

A CAREFUL study of the surface of the roadway in New York's Holland Tunnel, and even of the ducts in the ventilation system, fails to disclose any evidence of tire rubber. Scientists suspect, therefore, that rubber "worn" off automobile tires is burned off, not rubbed off.

BUY DIRECT

MASTER MECHANIC - UP TO 85% DISC.

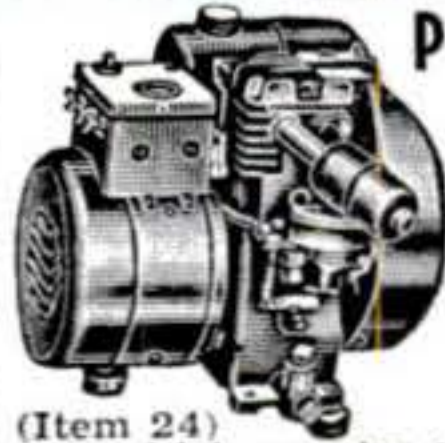

Portable LIGHT PLANT

PUSH BUTTON START
500-700 watts 110-120 v. — 60 cyc. A.C. Powered by a sturdy dependable, easy starting, air cooled 1 3/4 hp. gas engine. No wiring necessary, just plug in and operate. Plenty of current for any oil burner, freezer, brooder, pump, emergency lights, etc. which require up to 700 watts. Ideal for Civil Defense, Fire Depts; trailers & camps. Complete with Voltmeter and built-in winding to charge 6 v. auto batteries. Wt. 85 lbs. Fully guaranteed. Be prepared if war or storm knocks out power lines.

Reg. \$275.00 value. **\$143.50**
1000-1200 Watt Plant (Item 45) same as Item 24, but larger generator & engine. **\$199.50**

GIANT 2000-2500 WATT PLANT

110-120 V. 60 cyc., A.C. Absolutely the best made — exclusive dynamically balanced armature; heavy windings develop up to 3000 watt overload for motor starting. Skid-mounted — portable. Powered by easy starting Briggs or 6 hp. Wisconsin engine — complete with all accessories; engine easily disconnected for other uses. Big outlet box, voltmeter, no wiring necessary. Ample current for all purposes. Factory warranty and instructions included. Wt. 220 lbs. Reg. \$585.00. Special at. **\$299.50**

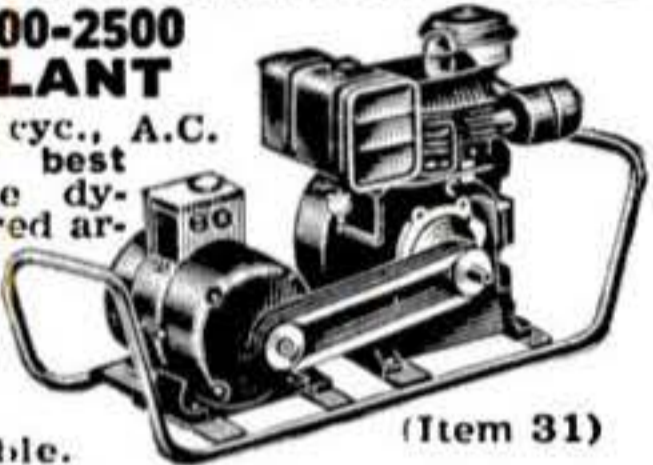

With Electric Self Starter (Item 179) **\$359.50**
GENERATOR ONLY and control box. **\$169.50**
Drive it with your engine or tractor (Item 162)

HI-LINE 6000 WATT PLANT Push Button Start, 115-230 v. 60 cycle A. C. A brute of a power plant with a rugged 13 hp. Wisconsin engine. Plenty of electricity for ranges, water heaters, freezers, pumps, machinery, etc. Affords both 110 and 220 volts. Ideal where heavy current is needed. Wt. 590 lbs. Easily worth \$995.00. (with self starter) Factory special. **\$645.00**

Same plant (with crank starter) (Item 166) Wt. 570 lbs. **\$585.00**
Generator and control box only, belt driven. Use your engine or tractor. Wt. 240 lbs. **\$345.00**

We Are World's Largest Mail Order Distributors of Light Plants

VARIABLE SPEED SELECTOR

Heavy duty, made by B. F. GOODRICH for industrial use. Provides instant speed changes for any drive. For machine tools, dryers, printing, conveyors, production lines, hoists — any operation requiring variable speed. Ideal for midge autos. Employs reliable "trouble free" planetary system. No hydraulic power losses or creeping. Infinite range, smooth operation, easy installation. 3 sizes: 1/2-1 hp. wt. 36 lbs.; 1-2 hp. wt. 55 lbs.; 2-3 hp. wt. 105 lbs. Reg. list \$228, \$252 and \$352. Brand new, in Goodrich boxes and guaranteed. Complete installation data included. Unprecedented surplus sacrifice **\$79.50, \$89.50 and \$114.50.**

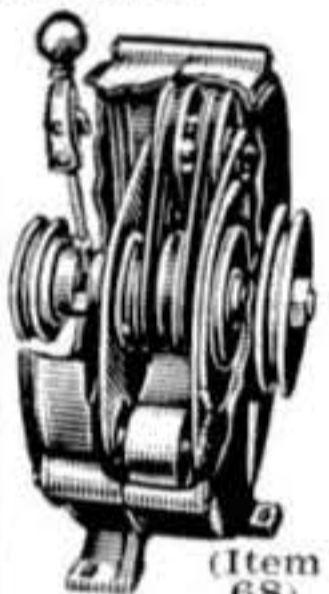

HEATING & VENTILATING FAN

(Item 10) Easily installed in furnace pipes. Forces even heat to all rooms. Over range, removes kitchen smoke and odors. Powerful continuous duty motor, 110-120 V. A.C. Quiet, super efficient fan moves huge volume of air (400 to 600 c.f.m.) 8" Fan, wt. 5 lb. **\$6.35**; 9" Fan, wt. 6 lbs. **\$7.45**; 10" Fan, wt. 7 lb. **\$8.45**; 12" Fan, wt. 8 lbs. **\$9.45.**



HIGH PRESSURE HAND PUMP

(Item 53) Positive displacement type. Cap. 550 gph. Completely self priming. 3/4" pipe thread inlet and outlet. Use for fuel or water transfer on boats, trailers, air craft, etc. Ideal for insecticides, emerg. sump pump or as vacuum pump. Wt. 15 lbs. Govt. cost \$95. Our Special. **\$12.95**

GAUGE TESTER

(Item 27) Precision made of solid bronze and steel by Ashcroft. (Cat. #1300-5). Calibrated weights (incl.) acting against hydraulic piston provides quick accurate testing of all pressure gauges up to 500 psi. Brand new. Wt. 90 lbs. Reg. \$318.00. Our Spec. **\$95.00**

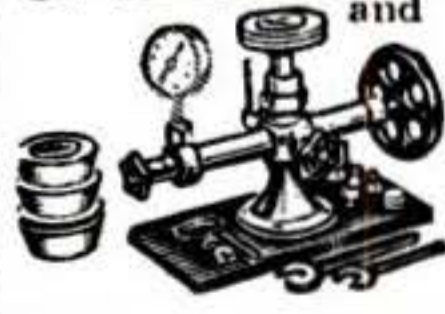

IMMEDIATE DELIVERY—ALL ITEMS

HEAVY DUTY ARC WELDER

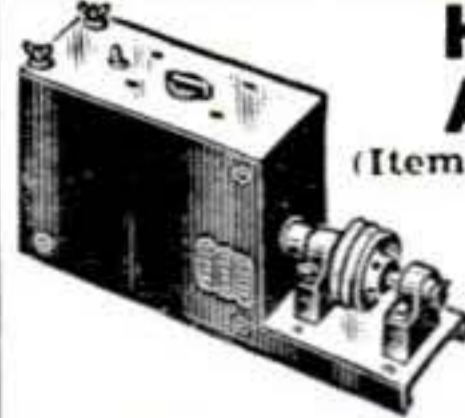

(Item 38) Use as portable or shop welder. 250 amps. D.C., Senior model. Made for years of trouble-free, continuous service. Will handle light or heavy jobs. Weld up to 1/2" plate using 1/4" rods. Built-in air-cooling system. Arc is easy to strike and hold, because of specially designed arc stabilizer. Hi-lo switch and dial control gives wide range of welding heats. Run welder at 2600 rpm. with tractor, jeep or 15 hp. gas engine, or 7 hp. elec. motor. Complete with instructions, guar. and double V belt or flat pulley. Wt. 110 lbs. **\$99.75**

A \$400 value at. **\$99.75**
MAGIC TERMINAL model same as above but with built-in 3rd terminal for low heat soldering and brazing. Special. **\$119.50**
WELDING KIT. Two 10 ft. leads, welding helmet, electrode holder, ground clamp. Sold only with welder at. **\$10.50**

A-C ARC WELDER (Item 168) Master Hi-Line A-C Arc Welder. 20-190 amp. output. Welds or cuts iron, steel, brass, etc. from 24 gauge to 5/8" with single pass. Operates from 220/230 V. 50/60 Cycle A-C line. None better. Meets REA requirements. Handles 1/16" to 1/4" rods. Adjustable output for any job. In sturdy steel cabinet, on casters. Full instru. and 1 yr. guar. incl. Wt. 210 lbs. Reg. \$250 value. **\$159.50**



(Item 169) 20-100 amp. A-C Welder operates on 110 or 220 V. Wt. 65 lbs. Worth \$125. **\$64.95**
(Item 181) Welding Kit incl. helmet, 2 leads, electrode holder, ground clamp, power cord and rods (sold only with welder) Wt. 12 lbs. **\$12.50**

CARRY-AIR



(Item 32) Stainless steel tank—capacity 500 cu. in. at 400 lbs. press. complete with inlet and shutoff valves, press. gauge, detachable air hose, tire chuck. Fill at any service station. Carry air for tire inflation, blowing out lines, spray painting, insecticides, etc. One emergency pays back cost. Wt. 10 lbs. Worth \$20.00. Our price. **\$8.95**
(Item 55) With big double tank (1000 cu. in.) **\$11.95**

POTTERS WHEEL

(Item 47) Complete, prof. equip. for making finest ceramics and pottery. Large dynamically balanced cast-aluminum reversible turntable with variable speed drive (38 to 140 rpm) controlled by foot-pedal. Built-in adjustable arm rests, water cup and wedging wire. 16x12" enclosed throwing table—ample area for largest pieces. Req. 1/4 hp. motor (not incl.). Can be set up on 20x24" table and stored on edge. Complete with pulleys, belts and instructions. Wt. 26 lbs. **\$59.95**



ANGLE DRILL

(Item 23) Fits into chuck of any electric or pneumatic drill or flex. shaft. Operates at any angle in a full 360° arc. Makes possible drilling, grinding, carving, routing, etc. in close cramped quarters. Makes impossible jobs easy. Made by Kett Tool Co. Complete with built-in chuck (1/4" capacity) and adjusting key. Hardened alloy gears. Precision built for heavy duty. Lists at \$39.95—while they last. **\$9.95**



RUBBER HOSE

New genuine Neoprene Hose — outlasts ordinary rubber 3 to 1. Reinforced with super tough cotton cord plies. Flexible. Easy Flo brass couplings with standard pipe threads for quick connections. Included. Pump water for irrigation, stock tanks, home, barn, fire fighting, etc. Pump Gas or Fuel Oil. Save more than 60%. (Inside Diam.) 1" 1 1/4" 1 1/2" Length 10 ft. 25 ft. 30 ft. Price 5.95 9.25 14.75



If specified we will send special hose for gas or oil at same prices. **TERRIFIC VALUES!**

Send 10c for a Big War Surplus Catalog. Included Free with Every Order.

MAKES SNOW REMOVAL REAL FUN!

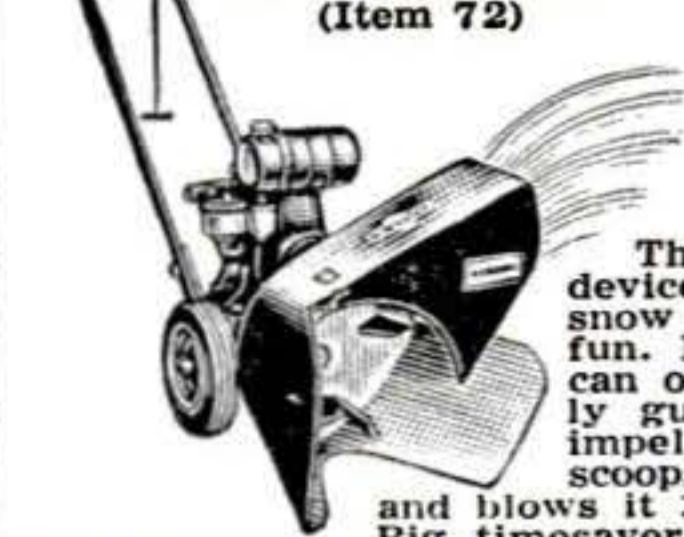

SNOW-BLO

(Item 72) The sensational device that makes snow removal real fun. Easy — a child can operate it. Safely guarded whirling impeller quickly scoops up the snow and blows it 25' either side. Big timesaver. Clears driveway and walks in a jiffy. Eliminates dangerous exhaustion and overtaxed heart, which kills so many every winter. BOYS! Make big money clearing snow for neighbors. Easily converted to lawn mower when desired. New silent electric model powered by 1/2 hp. motor clears 16" swath. Complete with shockproof 100' cord (Item 72) **\$139.50**
Gasoline Model with easy starting 2 hp. 4 cycle engine (Item 73) **\$159.50**
For large areas (2 1/2 hp. engine) (Item 74) **\$179.50**

We pay freight on Snow-Blos. FREE with purchase of any model, an extra 100' extension cord.

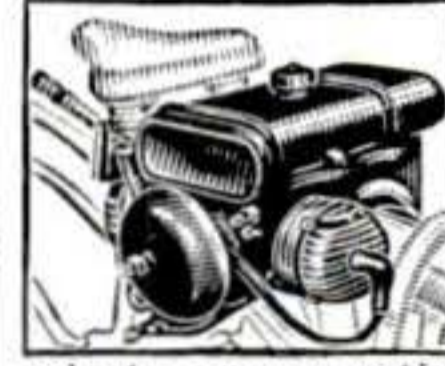

COMMANDO BIKE MOTOR

(Item 90) New, super-modern 1952 model. This job is the Cadillac of all bike motors. Sensational Auto-Clutch prevents killing motor at each stop. Also selects proper ratio on hills. Mounts behind and drives rear wheel with Dynarotor. Free Wheeling lever permits pedalling if desired. Rear Mounting eliminates fumes, heat, dirt, and hard steering. Easily installed in 15 minutes with home tools. Sturdy, trouble-free, easy starting, light weight. Airplane type engine; up to 150 miles per gallon. Fully guar. Ride for fun or profit. Ideal for deliveries, paper routes, messenger service, etc. Ride to work and save. The Commando Captain, 1 cylinder 1 1/2 hp. **\$99.75**
The Commando General, 2 cylinder 3 hp. (Item 91) **\$125.00**
All Commandos shipped prepaid in U.S.

FIRE EXTINGUISHER

(Item 39) Fully charged (at 1,000 lbs. P. S. I. or more) with CO2 (carbon dioxide), the proven miracle fire fighting chemical that smothers oil, gasoline and electrical fires. Play safe; keep one in your car, garage and home. Heavy ICC approved steel cylinder, valve and 3000 lb. gauge that shows available remaining pressure. REFILLABLE at nominal cost. Hose included for emergency tire inflator or air blast. Wt. 4 lbs. **\$19.50** Special. **\$6.95**



LARGE FIRE EXTINGUISHER

(Item 57) commercial size, 5 x 14 in. (275 cu. in.) heavy ICC approved steel cylinder charged at 1000 lbs. or more with CO2. Equipped with genuine Kidde Valve. Refillable. Hose incl. Suitable for fire depts., stores, garages, homes, etc. Wt. 18 lbs. **\$42.50** value. Spec. **\$15.85**

EXTENSION CORD

(Item 16) 40 ft. heavy duty, made of specially insulated No. 14 2-conductor wire. So tough that you can drive over it and yet amazingly flexible and easy to handle. Resists oil, grease or water. Extends electricity up to 400 ft. without voltage drop. Use indoors or out. Complete with heavy rubber plug and outlet. Wt. 2 1/2 lbs. Usually \$1.50—Special 40 ft. **\$1.99**
Comb: 2-40 ft. and 1-20 ft. (total 100 ft.) **\$4.95**
100 foot length (one piece) **\$4.85**
WIRE ONLY (Item 50) No fittings, 100 ft. **\$4.00**

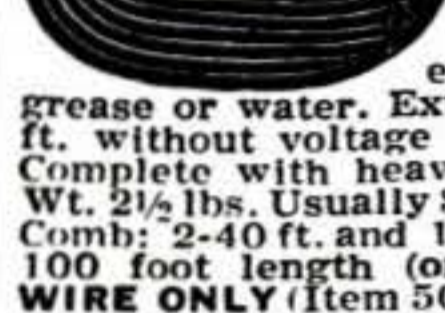

TRENCH-LAY WIRE

(Item 51) Anaconda ±10-2 cond., for buried service to barns, outdoor lights, etc. Absolutely impervious to soil and moisture. Wt. 25 lbs. per 100 ft. Special surplus price. 100 ft. coils. 19c per ft.; 250 ft., 18c per ft.; 500 ft., 7c per ft.

34 pc. SOCKET SET

(Item 59) Highest quality guar. non-breakable sockets made by Plomb, Snap On, etc. Complete range of 22 sockets from 1/4" thru 3/4" in 3/8" drive and 7/16" thru 1-1/16" in 1/2" drive. 2 speeder handles, 2 extensions, 2 slide heads, double 3/8 x 1/2 in. "L" handle, reversible ratchet. Adaptor bit, 2 end wrenches and metal tool box. For professional mechanics who want the best. Wt. 14 lbs. Easily worth \$34.50 while they last. **\$16.95**

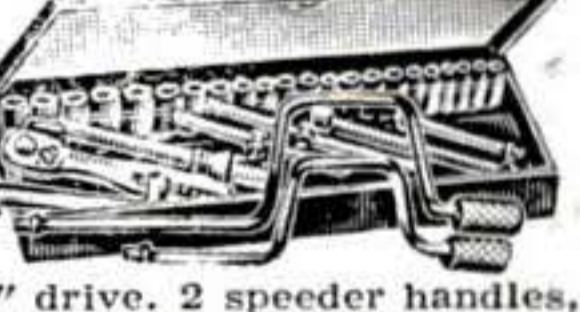

TIRE CHAINS

(Item 43) Extra heavy for dual truck tires. 7.50x20, triple side links, made by Intl. Chain. Reg. list \$57.50—our special. **\$19.50**

All items brand new. Prices f.o.b. Chicago area. 10 day Money back guarantee. Send check or M. O. **MASTER MECHANIC MFG. CO., DEPT. 96 Burlington, Wis.**

SOUTH BEND

Precision Lathes

For Better Machining

Whether you are doing production, maintenance, service or experimental work, you have need for South Bend Lathes. They produce better machining efficiently — especially when close tolerances are specified. Consequently, their use often results in appreciable savings in machining costs. And, being reasonable in price, they do not require heavy capital investment.

South Bend Lathes are your best buy. They're designed right — built right. Check coupon for complete information.



Building Better Tools Since 1906

SOUTH BEND LATHE
SOUTH BEND, INDIANA

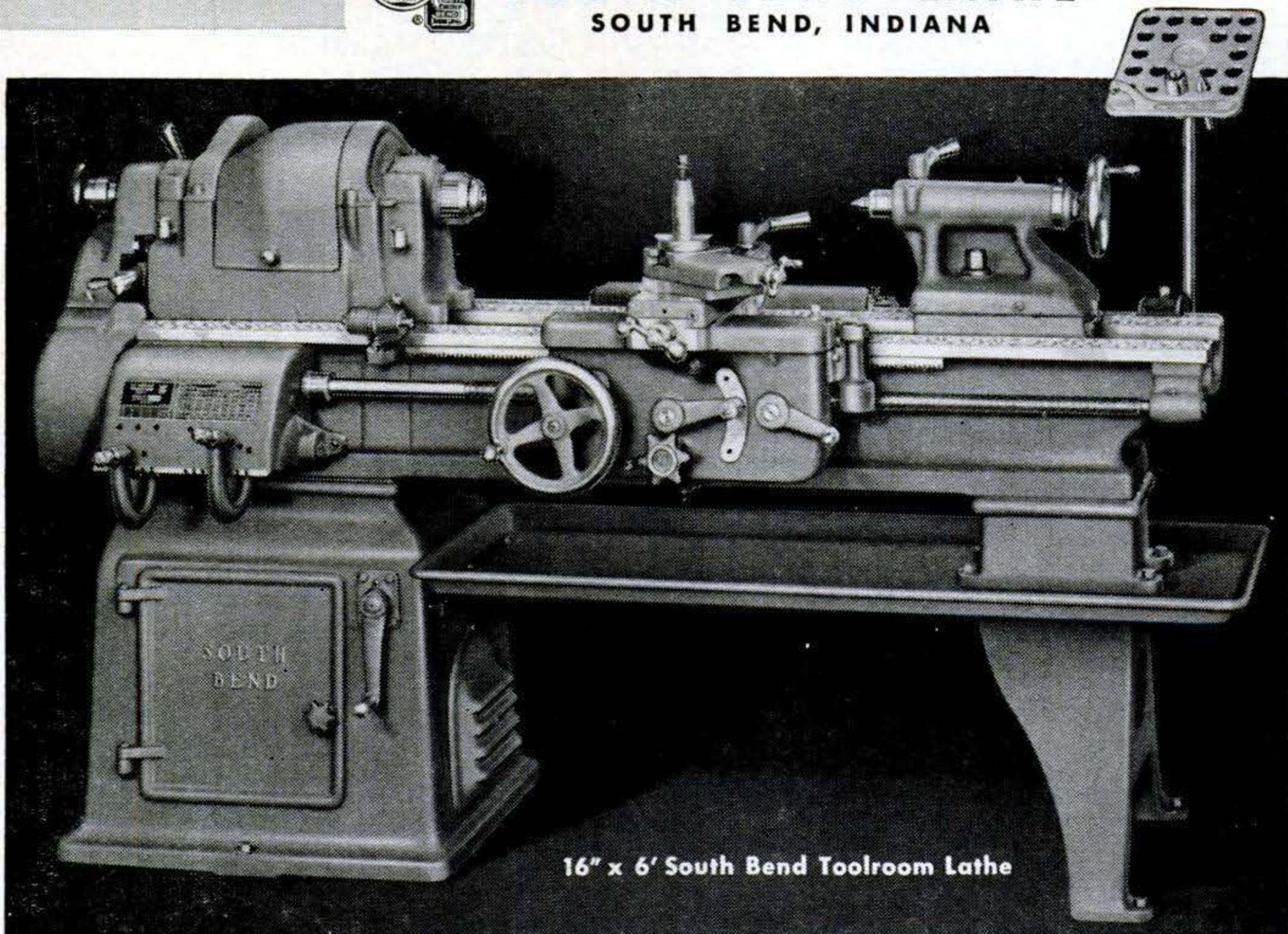

16" x 6' South Bend Toolroom Lathe

SPECIFICATIONS OF SOUTH BEND 16" LATHES

Swing: 16 1/4" over bed, 9 5/8" over cross slide.
 Bed Lengths 6 to 12 feet
 Center Distance 33 1/2" to 105 1/2"
 Cross Slide Travel 10 1/2"
 Spindle Speeds:
 8-Speed Drive 25 to 770 r.p.m.
 12-Speed Drive 20 to 945 r.p.m.

Collet Capacity 1"
 Spindle Bore 1 3/8"
 Power Feeds:
 Longitudinal: 48 R.H. or L.H.; .0015" to .0841"
 Cross Feeds: 480006" to .0312"
 Thread Cutting: 48 R.H. or L.H.
 pitches 4 to 224 per inch

Send Information Checked:

16" TOOLROOM LATHES

16" QUICK CHANGE GEAR LATHES

LATHE ATTACHMENTS

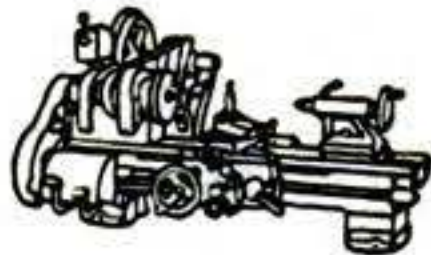

9" and 10" BENCH LATHES

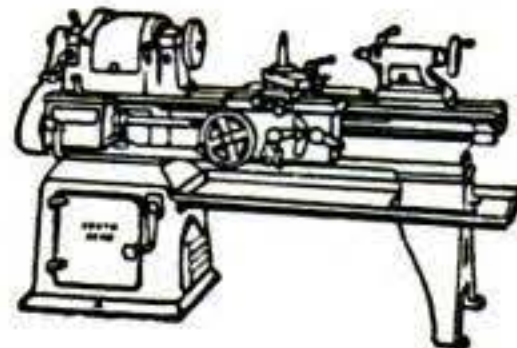

10" TO 16-24" FLOOR LATHES



14" DRILL PRESSES

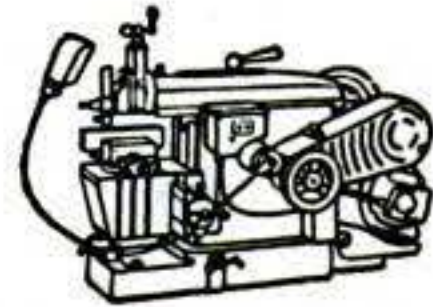

7" BENCH SHAPERS

Name _____

Street _____

City _____ Zone _____ State _____

TURRET LATHES
1/2" and 1" Collet

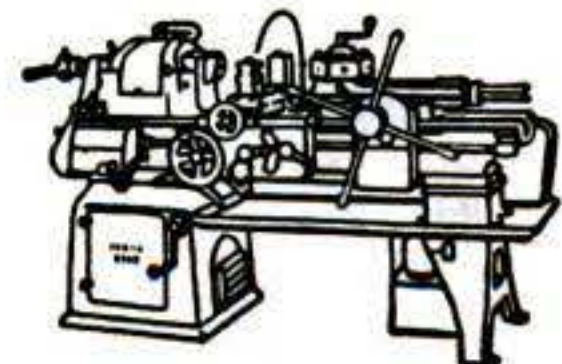

A new year... for opportunity

1952 OPPORTUNITY OUTLOOK

RADIO-TV



Wide-open, fast-moving field. Look for big gains in TV—new stations, UHF channels, improved color. Excellent opportunities for qualified servicemen, electronics experts, operating technicians. Up-to-date training essential.

AVIATION



Defense orders expected to double airframe and engine production. There's already an urgent need for aircraft draftsmen and aeronautics engineers, tool designers, mold-loftsmen, machine shop workers, mechanics. Good openings for trained newcomers.

AUTOMOTIVE



Cutbacks in new-car production will keep old cars on the road. Means big business for auto mechanics, body rebuilders and refinishers. Increasing demands for new men. Experience not so important as proper training.

ENGINEERING



New engineers can expect many attractive offers, can take their pick of jobs. Starting salaries of \$100 a week. Industry desperately needs chemical, electrical and mechanical engineers. Will readily accept men trained by reputable schools.

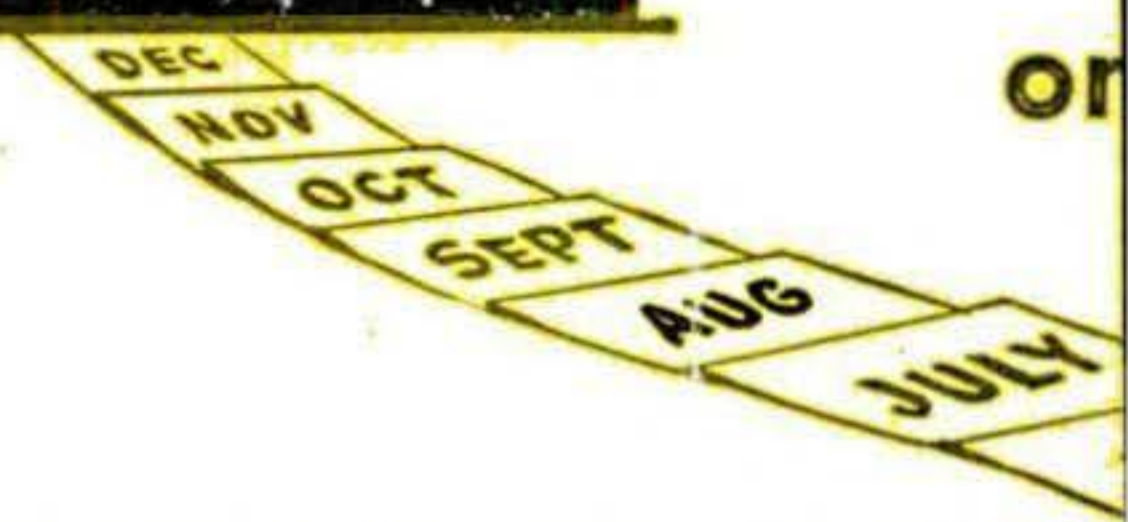

YOU'RE too smart to stay in the same old rut! You know that you have one life—that's all. So you've thought about *doing* something that would advance you in your work, increase your income.

The time to get started is *now*. And you can take the first step toward Personal Success this very minute!

Just look over the prestamped, preaddressed card below and mark the I. C. S. course in your field of interest. Then mail it—*today!*

We'll send you complete information on the International Correspondence Schools, and how they can give you the training you need to get ahead faster. Cost is low, texts are easy to understand, and every student gets *personal* service.

The time to "take steps" is **RIGHT NOW!**

DRAFTING

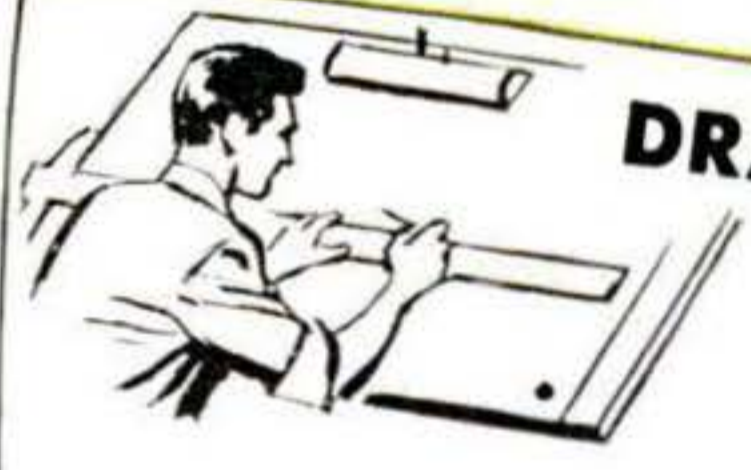

Opportunities are exceptionally good. Will get even better during the year. Qualified men due for rapid advancement. Quick training available for beginners. Aircraft, ship, electrical drafting head list of essential classifications.

BUSINESS



Outlook is especially bright for accountants, federal tax experts, traffic managers, typists, stenographers. Employers will put greater emphasis on specialized training in effort to trim costs and step up efficiency. Self-improvement will be welcomed and rewarded.

ACT NOW! Mark and mail this prepaid postcard for complete information on what I. C. S. can do for *you* in '52.

FREE HIGH SCHOOL BONUS

By taking a regular I. C. S. course, you can earn *bonus credits* toward a high school diploma.

You choose whatever course you want (there are

more than 400 to choose from). Then, as you study, you automatically earn up to one-half the credits required for an I. C. S. high school diploma. No extra work. No extra cost.

It's a free bonus you get with every I. C. S. course!

Get into...

PLASTIC LAMINATING

AT HOME!

Sensational New
"ONE MAN BUSINESS"
...pays \$10 to \$20 profit for each dollar of cost.

Make \$20 to \$30 a day by our **MAGIC MAIL PLAN**... get orders and cash from your mailman!

Here's the newest and most fascinating of all home-operated businesses. For the first time, a simplified machine brings the fabulous profits of Plastic Sealing and Plastic Laminating within the reach of the small operator. Can be

operated in a corner of the kitchen, basement, or garage. And any man or woman, regardless of age, education, or experience—can learn this interesting work in a few minutes of reading—can turn out professional jobs after one hour's practice.

TWO EXCITING FIELDS FOR BIG PROFITS!

No house-to-house canvassing. No face-to-face selling. We not only supply the equipment you need for the work, but also show you exactly how to cash in big daily profits from two big demand fields.

A FORTUNE IN PLASTIC SEALING

Millions of people want to protect valuable cards, photographs, documents and papers against wear, soil, and damage. By our MAGIC MAIL Plan you get this business through the mails. Open envelopes and take out money and orders. Details of this plan will amaze you. It will be sent free. Just mail coupon.

ENORMOUS PROFITS IN LAMINATING

A creative, artistic business. Gift shops sell your entire output. Just a few of thousands of giftwares illustrated on this page. Beautiful colors. Endless designs. Exclusive "one of a kind" appeal brings sales at ten to twenty times the cost of materials. Beautiful illustrations and instructions for making these artistic novelties sent free.



Thousands of Beautiful Art Creations

No one yet has been able to list the thousands of gorgeous articles that can be made by Laminating as explained in our Free Information. Just a few of these objects are

- COSTUME JEWELRY—CIGARETTE BOXES—JEWEL CASES—GLOVE AND HANDKERCHIEF BOXES—CUFF LINKS—NOVELTY BUTTONS—TRAY—CANDLESTICKS—COASTERS—CLOCK CASES—LAMP BASES—PICTURE FRAMES—BOOK ENDS—PAPER KNIVES—KEY CHAIN CHARMS—CHECKERS—CHESSMEN—ADVERTISING SIGNS—NAME-PLATES—BOOKMARKS—BELT BUCKLES—TIE RACKS—KEEP-SAKES OF ALL KINDS.

The opportunities in Plastic Laminating are so big that space here does not permit even skimming the surface. To get any idea

FREE

at all of the size of these markets and your place in this sensational business you must read the details. See for yourself how easy it is to do the work—how you can put plastic sheets into your machine and take out a fortune—how money and orders come to you in the mail—how gift shops clamor to get more and more of your creations—how you can start with one machine and build up a big production plant with others doing the work—how you can get money and business from every State in the Union—how you can achieve independence without study or experience.



RUSH COUPON

FREE

Never before has such an opportunity been offered the small, home-operator—an opportunity to gain complete personal independence in a big money business of your own. All information, fully illustrated with pictures, is free. Send the coupon—or send your name on a post card. There is no charge now, or at any other time. We may be limited in the number of Warner Laminators that can be made up, so don't put this off. Send for the information on this exciting opportunity today.

WARNER ELECTRIC CO.
1512 Jarvis, Dept. 2-A, Chicago 26, Illinois

WARNER ELECTRIC CO. Dept. 2-A
1512 Jarvis Avenue, Chicago 26, Illinois

Rush complete information with illustrations showing the things I can make and the money possibilities in Plastic Laminating. All this is free. I do not pay a penny now or at any other time. No salesman is to call. Send all facts by prepaid mail. Be sure to tell me how I get orders and money from my Postman by your MAGIC MAIL Plan.

NAME _____
 ADDRESS _____
 CITY _____ ZONE _____ STATE _____



\$5-\$10-and \$20 BILLS COME TO YOU IN THE MAIL

By our MAGIC MAIL Plan you sit at home, send out mail, and get back money and orders. Additional profits in supplying local people with lifetime protection for articles such as these:

- SNAPSHOTS—IDENTIFICATION CARDS—DISCHARGE PAPERS—DRIVERS' LICENSES—SOCIAL SECURITY CARDS—VOTERS REG. CARDS—MENUS—BIRTH CERTIFICATES—CREDIT CARDS—BIRTH AND WEDDING ANNOUNCEMENTS—RAILROAD PASSES—IMPORTANT DOCUMENTS OF ALL KINDS.

Lifetime protection. See now laminating protects against wear, soiling, and moisture damage with its smooth, flexible, plastic covering on each side. LIFE-TIME PROTECTION needed for valuable or sentimental objects of all kinds—even a priceless whisp of hair can be laminated. Think of the countless thousands of profit items for your Laminating Press.

